

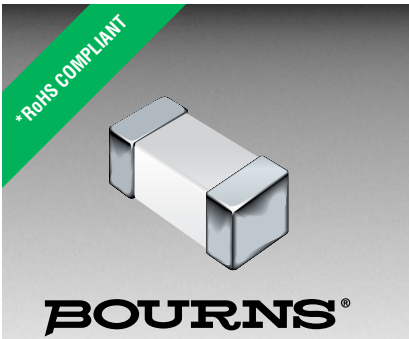

**THE DATASHEET OF
CE201210-R33J**





Features

- 0805 size
- Available in E12 Series
- High frequency
- Nickel barrier
- RoHS compliant*



This series is currently available but not recommended for new designs.

CE201210 Series - Multi-Layer Chip Inductors

Electrical Specifications

Bourns Part No.	Inductance		Q Typ.	Test Frequency	SRF MHz	DCR	I rms
	nH	Tol. %	@100 MHz	L MHz	Min.	mohm Max.	mA Max.
CE201210-1N5D	1.5	± 0.3 nH	21	100	4000	100	300
CE201210-1N8D	1.8	± 0.3 nH	18	100	4000	100	300
CE201210-2N2D	2.2	± 0.3 nH	18	100	4000	100	300
CE201210-2N7D	2.8	± 0.3 nH	19	100	4000	100	300
CE201210-3N3J	3.3	± 5	16	100	4000	130	300
CE201210-3N9J	3.9	± 5	18	100	4000	150	300
CE201210-4N7J	4.7	± 5	18	100	3500	200	300
CE201210-5N6J	5.6	± 5	20	100	3200	230	300
CE201210-6N8J	6.8	± 5	20	100	2800	250	300
CE201210-8N2J	8.2	± 5	21	100	2400	280	300
CE201210-10NJ	10	± 5	20	100	2100	300	300
CE201210-12NJ	12	± 5	21	100	1900	350	300
CE201210-15NJ	15	± 5	22	100	1600	400	300
CE201210-18NJ	18	± 5	24	100	1500	450	300
CE201210-22NJ	22	± 5	23	100	1400	500	300
CE201210-27NJ	27	± 5	23	100	1300	550	300
CE201210-33NJ	33	± 5	24	100	1200	600	300
CE201210-39NJ	39	± 5	23	100	1000	650	300
CE201210-47NJ	47	± 5	23	100	900	700	300
CE201210-56NJ	56	± 5	23	100	800	750	300
CE201210-68NJ	68	± 5	25	100	700	800	300
CE201210-82NJ	82	± 5	24	100	600	900	300
CE201210-R10J	100	± 5	23	100	600	900	300
CE201210-R12J	120	± 5	22	50	500	950	300
CE201210-R15J	150	± 5	22	50	500	1000	300
CE201210-R18J	180	± 5	23	50	400	1100	300
CE201210-R22J	220	± 5	20	50	350	1200	300
CE201210-R27J	270	± 5	20	50	300	1300	300
CE201210-R33J	330	± 5	22	50	250	1400	300
CE201210-R39J	390	± 5	17	50	250	1300	300
CE201210-R47J	470	± 5	17	50	200	1500	300

General Specifications

Temperature Rise30 °C max. at rated current
 Operating Temperature-40 °C to +105 °C
 Storage Temperature-40 °C to +105 °C
 Reflow Soldering .. 230 °C, 50 sec. max.
 Resistance to Soldering Heat 260 °C, 10 sec.

Materials

Base Material.....Ceramic
 Terminal.....Ag/Ni/Sn
 Packaging:
 CE201210-1N5D through
 CE201210-82NJ.... 4,000 pcs. per reel
 CE201210-R10J through
 CE201210-R27J.... 4,000 pcs. per reel
 CE201210-R33J through
 CE201210-R47J.... 2,000 pcs. per reel

Product Dimensions

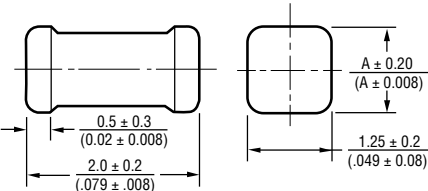

Model	Dimension A
CE201210-1N5D through CD201210-82NJ	$\frac{0.83}{(0.033)}$
CE201210-R10J through CE201210-R39J	$\frac{1.00}{(0.039)}$
CE201210-R47J	$\frac{1.25}{(0.050)}$

Packaging Specifications

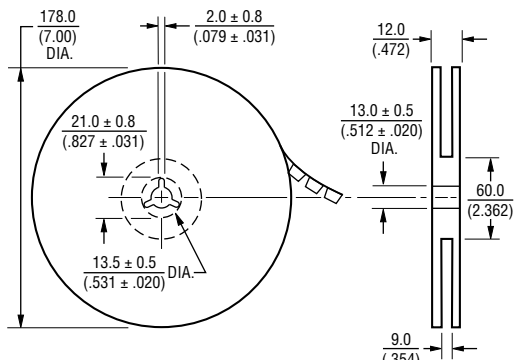

Recommended Layout

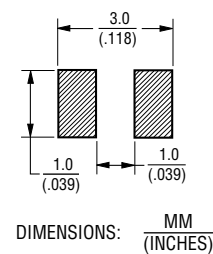

WARNING Cancer and Reproductive Harm
www.P65Warnings.ca.gov

*RoHS Directive 2002/95/EC Jan. 27, 2003 including annex and RoHS Recast 2011/65/EU June 8, 2011. Specifications are subject to change without notice. Users should verify actual device performance in their specific applications. The products described herein and this document are subject to specific legal disclaimers as set forth on the last page of this document, and at www.bourns.com/docs/legal/disclaimer.pdf.

Applications

- Mobile phones
- Cellular phones
- CTV, VCR, HIC, FDD

CE201210 Series - Multi-Layer Chip Inductors

BOURNS®

Electrical Specifications

Q vs. Frequency Characteristics

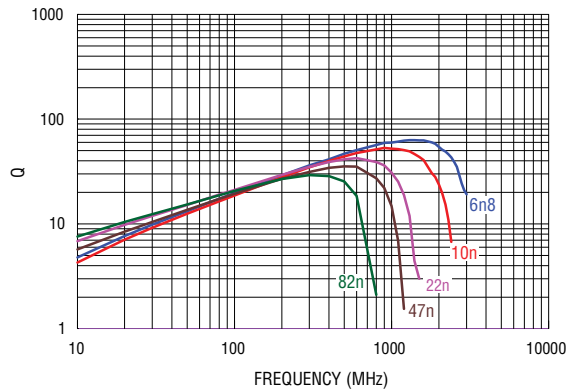

Inductance vs. Frequency Characteristics

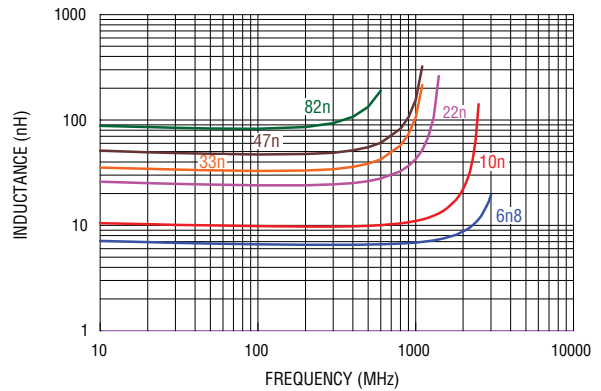

BOURNS®

Asia-Pacific: Tel: +886-2 2562-4117 • Email: asiacus@bourns.com

EMEA: Tel: +36 88 520 390 • Email: eurocus@bourns.com

The Americas: Tel: +1-951 781-5500 • Email: americus@bourns.com

www.bourns.com

REV. 11/18

Specifications are subject to change without notice.

Users should verify actual device performance in their specific applications.

The products described herein and this document are subject to specific legal disclaimers as set forth on the last page of this document, and at www.bourns.com/docs/legal/disclaimer.pdf.

This legal disclaimer applies to purchasers and users of Bourns® products manufactured by or on behalf of Bourns, Inc. and its affiliates (collectively, “Bourns”).

Unless otherwise expressly indicated in writing, Bourns® products and data sheets relating thereto are subject to change without notice. Users should check for and obtain the latest relevant information and verify that such information is current and complete before placing orders for Bourns® products.

The characteristics and parameters of a Bourns® product set forth in its data sheet are based on laboratory conditions, and statements regarding the suitability of products for certain types of applications are based on Bourns’ knowledge of typical requirements in generic applications. The characteristics and parameters of a Bourns® product in a user application may vary from the data sheet characteristics and parameters due to (i) the combination of the Bourns® product with other components in the user’s application, or (ii) the environment of the user application itself. The characteristics and parameters of a Bourns® product also can and do vary in different applications and actual performance may vary over time. Users should always verify the actual performance of the Bourns® product in their specific devices and applications, and make their own independent judgments regarding the amount of additional test margin to design into their device or application to compensate for differences between laboratory and real world conditions.

Unless Bourns has explicitly designated an individual Bourns® product as meeting the requirements of a particular industry standard (e.g., ISO/TS 16949) or a particular qualification (e.g., UL listed or recognized), Bourns is not responsible for any failure of an individual Bourns® product to meet the requirements of such industry standard or particular qualification. Users of Bourns® products are responsible for ensuring compliance with safety-related requirements and standards applicable to their devices or applications.

Bourns® products are not recommended, authorized or intended for use in nuclear, lifesaving, life-critical or life-sustaining applications, nor in any other applications where failure or malfunction may result in personal injury, death, or severe property or environmental damage. Unless expressly and specifically approved in writing by two authorized Bourns representatives on a case-by-case basis, use of any Bourns® products in such unauthorized applications might not be safe and thus is at the user’s sole risk. Life-critical applications include devices identified by the U.S. Food and Drug Administration as Class III devices and generally equivalent classifications outside of the United States.

Bourns expressly identifies those Bourns® standard products that are suitable for use in automotive applications on such products’ data sheets in the section entitled “Applications.” Unless expressly and specifically approved in writing by two authorized Bourns representatives on a case-by-case basis, use of any other Bourns® standard products in an automotive application might not be safe and thus is not recommended, authorized or intended and is at the user’s sole risk. If Bourns expressly identifies a sub-category of automotive application in the data sheet for its standard products (such as infotainment or lighting), such identification means that Bourns has reviewed its standard product and has determined that if such Bourns® standard product is considered for potential use in automotive applications, it should only be used in such sub-category of automotive applications. Any reference to Bourns® standard product in the data sheet as compliant with the AEC-Q standard or “automotive grade” does not by itself mean that Bourns has approved such product for use in an automotive application.

Bourns® standard products are not tested to comply with United States Federal Aviation Administration standards generally or any other generally equivalent governmental organization standard applicable to products designed or manufactured for use in aircraft or space applications. Bourns expressly identifies Bourns® standard products that are suitable for use in aircraft or space applications on such products’ data sheets in the section entitled “Applications.” Unless expressly and specifically approved in writing by two authorized Bourns representatives on a case-by-case basis, use of any other Bourns® standard product in an aircraft or space application might not be safe and thus is not recommended, authorized or intended and is at the user’s sole risk.

The use and level of testing applicable to Bourns® custom products shall be negotiated on a case-by-case basis by Bourns and the user for which such Bourns® custom products are specially designed. Absent a written agreement between Bourns and the user regarding the use and level of such testing, the above provisions applicable to Bourns® standard products shall also apply to such Bourns® custom products.

Users shall not sell, transfer, export or re-export any Bourns® products or technology for use in activities which involve the design, development, production, use or stockpiling of nuclear, chemical or biological weapons or missiles, nor shall they use Bourns® products or technology in any facility which engages in activities relating to such devices. The foregoing restrictions apply to all uses and applications that violate national or international prohibitions, including embargos or international regulations. Further, Bourns® products and Bourns technology and technical data may not under any circumstance be exported or re-exported to countries subject to international sanctions or embargoes. Bourns® products may not, without prior authorization from Bourns and/or the U.S. Government, be resold, transferred, or re-exported to any party not eligible to receive U.S. commodities, software, and technical data.

To the maximum extent permitted by applicable law, Bourns disclaims (i) any and all liability for special, punitive, consequential, incidental or indirect damages or lost revenues or lost profits, and (ii) any and all implied warranties, including implied warranties of fitness for particular purpose, non-infringement and merchantability.

For your convenience, copies of this Legal Disclaimer Notice with German, Spanish, Japanese, Traditional Chinese and Simplified Chinese bilingual versions are available at:

Web Page: <http://www.bourns.com/legal/disclaimers-terms-and-policies>

PDF: <http://www.bourns.com/docs/Legal/disclaimer.pdf>

Looking for pricing, stock, or lifecycle information?

Click below to explore more details on WIN SOURCE:

 [View CE201210-R33J on WIN SOURCE](#)

 [Bourns Inc. Information](#)

Optimize Your Supply Chain with WIN SOURCE Solutions

-  Global Sourcing Solution
-  Obsolete Management
-  Cost Control Management
-  Shortage Management
-  Alternative Solution
-  Excess Inventory Management