



**THE DATASHEET OF
1267AY-3R3N=P3**



DG8040C

Inductance Range: 1.0~100μH

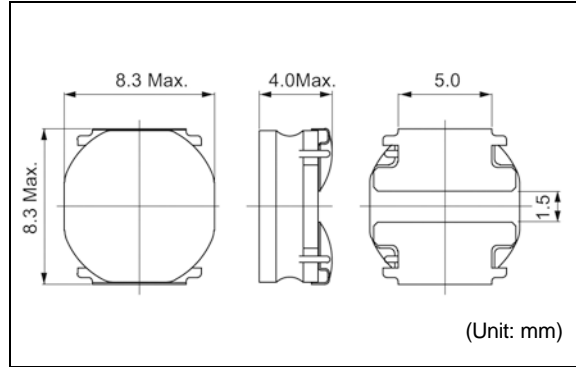

Recommended patterns
推荐焊盘尺寸

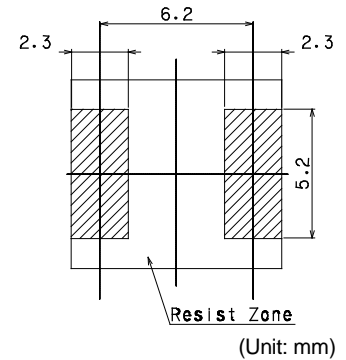

FEATURES 特点

- Magnetic Shield.
- Ideal for a variety of DC-DC converter inductor applications.
- Operating temperature range : -40~+85°C
- 闭磁路构造
- 最适用于各种设备的DC-DC Converter 中
- 使用温度范围: -40~+85°C

STANDARD PART NUMBERS 标准零件号码

TYPE DG8040C (Quantity/reel; 1000 PCS)

零件号码	电感值 ⁽¹⁾	公差	测试频率	最大直流电阻 ⁽²⁾	最大电感值减小电流 ⁽³⁾	最大温度上升电流 ⁽³⁾
Part Number	Inductance ⁽¹⁾ L(μH)	Tolerance (%)	Test Frequency (MHz)	DC Resistance ⁽²⁾ mΩ Max. (Typ.)	Inductance Decrease Current ⁽³⁾ (A) Max. (Typ.) ΔL/L=30%	Temperature Rise Current ⁽³⁾ ΔT=40°C (A) Max. (Typ.)
1267AY-1R0N=P3	1.0	±30	100	8.4 (7)	10.4 (13.8)	8.4 (9.9)
1267AY-1R5N=P3	1.5	±30	100	10.8 (9)	8.2 (10.9)	7.3 (8.6)
1267AY-2R2N=P3	2.2	±30	100	13.2 (11)	7.4 (9.8)	6.5 (7.7)
1267AY-3R3N=P3	3.3	±30	100	15.6 (13)	6.1 (8.1)	6.1 (7.2)
1267AY-4R7N=P3	4.7	±30	100	20.4 (17)	5.1 (6.8)	5.3 (6.2)
1267AY-6R8N=P3	6.8	±30	100	26.4 (22)	4.0 (5.3)	4.5 (5.3)
1267AY-100M=P3	10	±20	100	39.6 (33)	3.3 (4.5)	3.9 (4.5)
1267AY-150M=P3	15	±20	100	58.8 (49)	2.6 (3.5)	3.2 (3.8)
1267AY-220M=P3	22	±20	100	74.4 (62)	2.3 (3.0)	2.8 (3.2)
1267AY-330M=P3	33	±20	100	120.0 (100)	1.9 (2.5)	2.2 (2.6)
1267AY-470M=P3	47	±20	100	168.0 (140)	1.6 (2.1)	1.9 (2.2)
1267AY-680M=P3	68	±20	100	240.0 (200)	1.3 (1.7)	1.6 (1.9)
1267AY-101M=P3	100	±20	100	336.0 (280)	1.1 (1.4)	1.3 (1.5)

(1) Inductance is measured with a LCR meter 4284A (Agilent Technologies) or equivalent.
Test frequency at 100kHz

(2) DC resistance is measured with 34420A (Agilent Technologies) or 3541 (HIOKI). (Reference ambient temperature 25°C)

(3) Maximum allowable DC current is that which causes a 30% inductance reduction from the initial value, or coil temperature to rise by 40°C, whichever is smaller. (Reference ambient temperature 20°C)

(1) LCR仪表4284A (Agilent技术)或者功能相同的仪器在100kHz下测试电感值。

(2) 通过数码万用表34420A (Agilent技术) 或者3541(HIOKI)测试直流电阻。(环境温度为25°C)

(3) 允许最大直流电的范围是以下两者中比较小的一个: 引起电感值从最初值降低30%, 或者线圈温度升高40°C。(参考周围环境温度20°C)。

Looking for pricing, stock, or lifecycle information?

Click below to explore more details on WIN SOURCE:

- ⊖ [View 1267AY-3R3N=P3 on WIN SOURCE](#)
- ⊖ [Murata Electronics North America Information](#)

Optimize Your Supply Chain with WIN SOURCE Solutions

- ✓ Global Sourcing Solution
- ✓ Obsolete Management
- ✓ Cost Control Management
- ✓ Shortage Management
- ✓ Alternative Solution
- ✓ Excess Inventory Management