

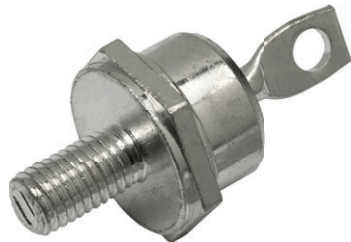

**THE DATASHEET OF
VS-1N3208**



Silicon Rectifier Diodes, (Stud Version) 15 A



DO-5 (DO-203AB)

FEATURES

- Low thermal impedance
- High case temperature
- Excellent reliability
- Maximum design flexibility
- Material categorization: for definitions of compliance please see www.vishay.com/doc?99912



RoHS
COMPLIANT

PRIMARY CHARACTERISTICS

$I_{F(AV)}$	15 A
Package	DO-5 (DO-203AB)
Circuit configuration	Single

MAJOR RATINGS AND CHARACTERISTICS

PARAMETER	TEST CONDITIONS	VALUES	UNITS
$I_{F(AV)}$		15 ⁽¹⁾	A
	T_C	150 ⁽¹⁾	°C
I_{FSM}	50 Hz	239	A
	60 Hz	250 ⁽¹⁾	
I^2t	50 Hz	286	A ² s
	60 Hz	260	
$I^2\sqrt{t}$		3870	A ² √s
V_{RRM}	Range	50 to 600	V
T_J		-65 to +175	°C

Note

⁽¹⁾ JEDEC® registered values

ELECTRICAL SPECIFICATIONS

VOLTAGE RATINGS

TYPE NUMBER	V_{RRM} , MAXIMUM REPETITIVE PEAK REVERSE VOLTAGE ($T_J = -65\text{ °C TO }175\text{ °C}$) V	V_{RM} , MAXIMUM DIRECT REVERSE VOLTAGE ($T_J = -65\text{ °C TO }175\text{ °C}$) V
VS-1N3208	50 ⁽¹⁾	50 ⁽¹⁾
VS-1N3209	100 ⁽¹⁾	100 ⁽¹⁾
VS-1N3210	200 ⁽¹⁾	200 ⁽¹⁾
VS-1N3211	300 ⁽¹⁾	300 ⁽¹⁾
VS-1N3212	400 ⁽¹⁾	400 ⁽¹⁾
VS-1N3213	500 ⁽¹⁾	500 ⁽¹⁾
VS-1N3214	600 ⁽¹⁾	600 ⁽¹⁾

Notes

- Basic type number indicates cathode to case. For anode to case, add "R" to part number, e.g. 1N3208R, 1N3209R
- ⁽¹⁾ JEDEC® registered values



FORWARD CONDUCTION					
PARAMETER	SYMBOL	TEST CONDITIONS		VALUES	UNITS
Maximum average forward current at case temperature	$I_{F(AV)}$	180° sinusoidal conduction		15 ⁽¹⁾	A
				150 ⁽¹⁾	°C
Maximum peak one cycle non-repetitive surge current	I_{FSM}	Half cycle 50 Hz sine wave or 6 ms rectangular pulse	Following any rated load condition and with rated V_{RRM} applied	239	A
		Half cycle 60 Hz sine wave or 5 ms rectangular pulse		250 ⁽¹⁾	
		Half cycle 50 Hz sine wave or 6 ms rectangular pulse	Following any rated load condition and with V_{RRM} applied following surge = 0	284	
		Half cycle 60 Hz sine wave or 5 ms rectangular pulse		297	
Maximum I^2t for fusing	I^2t	t = 10 ms	With rated V_{RRM} applied following surge, initial $T_J = 150$ °C	286	A ² s
		t = 8.3 ms		260	
Maximum I^2t for individual device fusing		t = 10 ms	With $V_{RRM} = 0$ following surge, initial $T_J = 150$ °C	403	
		t = 8.3 ms		368	
Maximum $I^2\sqrt{t}$ for individual device fusing	$I^2\sqrt{t}$ ⁽²⁾	t = 0.1 ms to 10 ms, $V_{RRM} = 0$ following surge		3870	A ² √s
Maximum forward voltage drop	V_{FM}	$I_{F(AV)} = 15$ A (47.1 A peak), $T_C = 150$ °C		1.5 ⁽¹⁾	V
Maximum average reverse current	$I_{R(AV)}$	Maximum rated $I_{F(AV)}$ and $T_C = 150$ °C		10 ⁽¹⁾	mA

Notes

- (1) JEDEC® registered values
(2) I^2t for time $t_x = I^2\sqrt{t} \times \sqrt{t_x}$

THERMAL AND MECHANICAL SPECIFICATIONS					
PARAMETER	SYMBOL	TEST CONDITIONS		VALUES	UNITS
Maximum junction operating and storage temperature range	T_J, T_{Stg}			-65 to 175 ⁽¹⁾	°C
Maximum internal thermal resistance, junction to case	R_{thJC}	DC operation		0.65	°C/W
Thermal resistance, case to sink	R_{thCS}	Mounting surface, smooth, flat and greased		0.25	
Maximum allowable mounting torque (+0 %, -10 %)		Not lubricated thread, tightening on nut ⁽²⁾		3.4 (30)	
		Lubricated thread, tightening on nut ⁽²⁾		2.3 (20)	
		Not lubricated thread, tightening on hexagon ⁽³⁾		4.2 (37)	
		Lubricated thread, tightening on hexagon ⁽³⁾		3.2 (28)	
Weight				28.5	g
				1	oz.
Case style		JEDEC®		DO-5 (DO-203AB)	

Notes

- (1) JEDEC® registered values
(2) Recommended for pass-through holes
(3) Recommended for holed threaded heatsinks

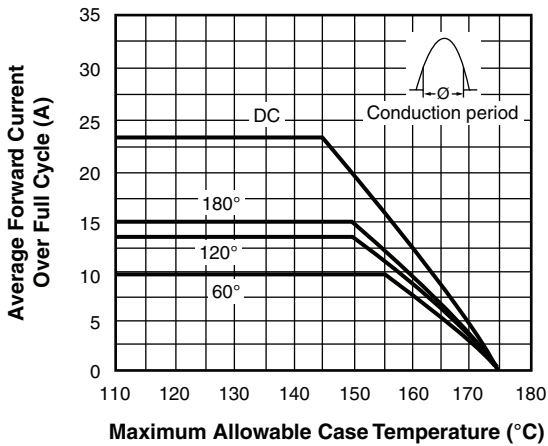

Fig. 1 - Average Forward Current vs. Maximum Allowable Case Temperature

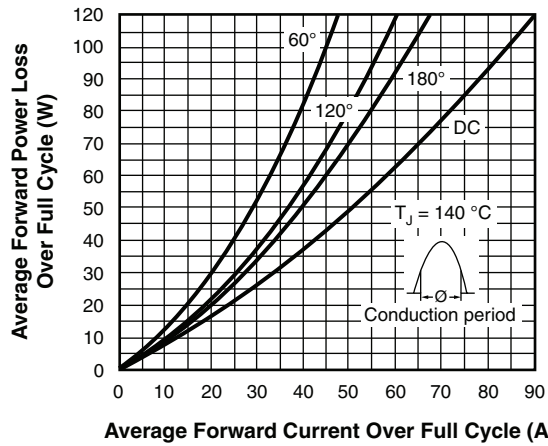

Fig. 3 - Maximum Low Level Forward Power Loss vs. Average Forward Current

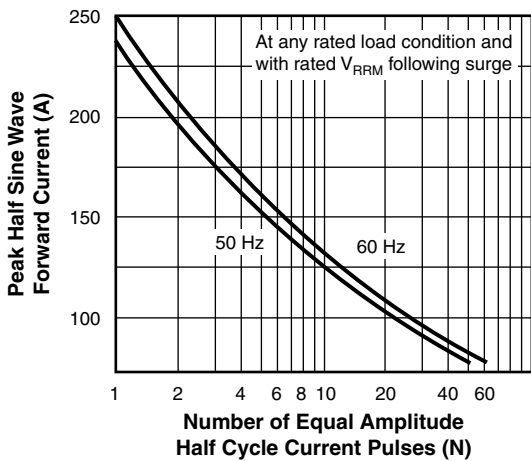

Fig. 2 - Maximum Non-Repetitive Surge Current vs. Number of Current Pulses

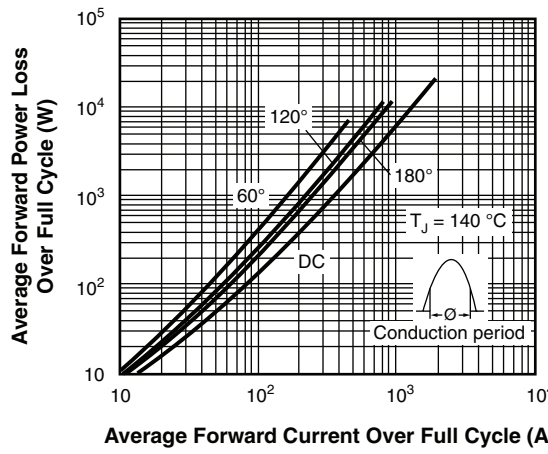

Fig. 4 - Maximum High Level Forward Power Loss vs. Average Forward Current

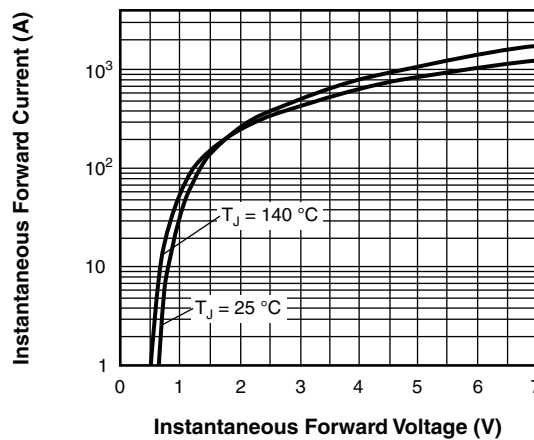
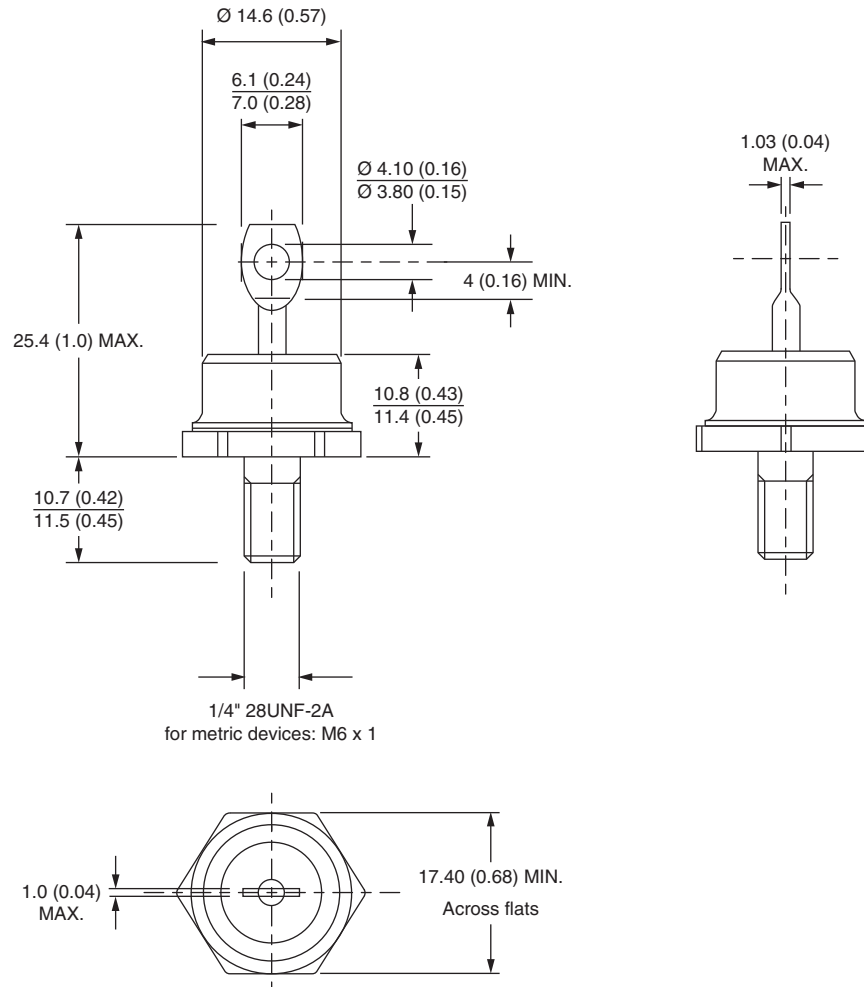

Fig. 5 - Maximum Forward Voltage vs. Forward Current

LINKS TO RELATED DOCUMENTS	
Dimensions	www.vishay.com/doc?95360

DO-203AB (DO-5) for 1N1183, 1N3765, 1N1183A, 1N2128A, 1N3208 Series

DIMENSIONS in millimeters (inches)





Disclaimer

ALL PRODUCT, PRODUCT SPECIFICATIONS AND DATA ARE SUBJECT TO CHANGE WITHOUT NOTICE TO IMPROVE RELIABILITY, FUNCTION OR DESIGN OR OTHERWISE.

Vishay Intertechnology, Inc., its affiliates, agents, and employees, and all persons acting on its or their behalf (collectively, "Vishay"), disclaim any and all liability for any errors, inaccuracies or incompleteness contained in any datasheet or in any other disclosure relating to any product.

Vishay makes no warranty, representation or guarantee regarding the suitability of the products for any particular purpose or the continuing production of any product. To the maximum extent permitted by applicable law, Vishay disclaims (i) any and all liability arising out of the application or use of any product, (ii) any and all liability, including without limitation special, consequential or incidental damages, and (iii) any and all implied warranties, including warranties of fitness for particular purpose, non-infringement and merchantability.

Statements regarding the suitability of products for certain types of applications are based on Vishay's knowledge of typical requirements that are often placed on Vishay products in generic applications. Such statements are not binding statements about the suitability of products for a particular application. It is the customer's responsibility to validate that a particular product with the properties described in the product specification is suitable for use in a particular application. Parameters provided in datasheets and / or specifications may vary in different applications and performance may vary over time. All operating parameters, including typical parameters, must be validated for each customer application by the customer's technical experts. Product specifications do not expand or otherwise modify Vishay's terms and conditions of purchase, including but not limited to the warranty expressed therein.

Except as expressly indicated in writing, Vishay products are not designed for use in medical, life-saving, or life-sustaining applications or for any other application in which the failure of the Vishay product could result in personal injury or death. Customers using or selling Vishay products not expressly indicated for use in such applications do so at their own risk. Please contact authorized Vishay personnel to obtain written terms and conditions regarding products designed for such applications.

No license, express or implied, by estoppel or otherwise, to any intellectual property rights is granted by this document or by any conduct of Vishay. Product names and markings noted herein may be trademarks of their respective owners.

Looking for pricing, stock, or lifecycle information?

Click below to explore more details on WIN SOURCE:

 [View VS-1N3208 on WIN SOURCE](#)

 [Vishay Information](#)

Optimize Your Supply Chain with WIN SOURCE Solutions

-  Global Sourcing Solution
-  Obsolete Management
-  Cost Control Management
-  Shortage Management
-  Alternative Solution
-  Excess Inventory Management