



## 50 Watt Zener Diodes

Qualified per MIL-PRF-19500/114

Qualified Levels:  
JAN, JANTX, and  
JANTXV

### DESCRIPTION

This series of high power 50W Zener diodes, JEDEC registered 1N2804B through 1N2846B and 1N4557B through 1N4564B, provide voltage regulation in values from 3.9 V to 200 V broad range of voltages. They may be operated up to 50 W with adequate mounting and heat sinking due to their low thermal resistance. These Zeners are also available in reverse polarity. On select part numbers, these Zeners are also available in JAN, JANTX, and JANTXV military qualifications.

**Important:** For the latest information, visit our website <http://www.microsemi.com>.

### FEATURES

- JEDEC registered 1N2804 through 1N2846B and 1N4557 through 1N4564B numbers.
- Internal solder bond construction.
- Hermetically sealed (welded).
- Zener voltage 3.9 V to 200 V.
- JAN, JANTX, and JANTXV qualifications also available per MIL-PRF-19500/114 on most family members (see [Electrical Characteristics](#) table).  
(See [Part Nomenclature](#) for all available options).
- Standard polarity is anode to case. Reverse polarity is available.
- RoHS compliant versions available (commercial grade only).

### APPLICATIONS / BENEFITS

- Regulates voltage over a broad range of operating current and temperature.
- Voltage tolerances of 10%, 5%, 2%, and 1% are available.
- Non-sensitive to ESD per MIL-STD-750 method 1020.
- Inherently radiation hard as described in Microsemi [MicroNote 050](#).

### MAXIMUM RATINGS

| Parameters/Test Conditions   | Symbol          | Value       | Unit |
|--|-----------------|-------------|------|
| Junction Temperature   | $T_J$           | -65 to +175 | °C   |
| Storage Temperature  | $T_{STG}$       | -65 to +200 | °C   |
| Thermal Resistance Junction to Case @ $T_C = 30\text{ °C} \pm 3\text{ °C}$ | $R_{\theta JC}$ | 2.0         | °C/W |
| Average Rated Power Dissipation @ $T_C \geq 75\text{ °C}$                  | $P_{M(AV)}$     | 50          | W    |
| Power Derating @ $T_C \geq +75\text{ °C}$                                  |                 | 0.5         | W/°C |
| Forward Voltage @ $I_F = 10A$  | $V_F$           | 1.5         | V    |
| Solder Temperature @ 10 s max  | $T_{SP}$        | 260         | °C   |



**TO-204AD (TO-3)  
Package**

#### **MSC – Lawrence**

6 Lake Street,  
Lawrence, MA 01841  
Tel: 1-800-446-1158 or  
(978) 620-2600  
Fax: (978) 689-0803

#### **MSC – Ireland**

Gort Road Business Park,  
Ennis, Co. Clare, Ireland  
Tel: +353 (0) 65 6840044  
Fax: +353 (0) 65 6822298

#### **Website:**

[www.microsemi.com](http://www.microsemi.com)

**MECHANICAL and PACKAGING**

- CASE: Industry standard TO-3 (TO-204AD), hermetically sealed, 0.052 inch diameter pins.
- FINISH: Solder dipped tin-lead over nickel plated alloy 52. Solderable per MIL-STD-750 method 2026. RoHS compliant matte-tin plating is also available on commercial grade only.
- POLARITY: Standard polarity units are connected anode to case. Reverse polarity (cathode to case) is indicated by suffix R. In either example, both pins are common with one another as anode or cathode (see [Figure 2](#)).
- WEIGHT: Approximately 15 grams.
- MOUNTING HARDWARE: Consult factory for optional insulator and sheet metal screws.
- See [Package Dimensions](#) on last page.

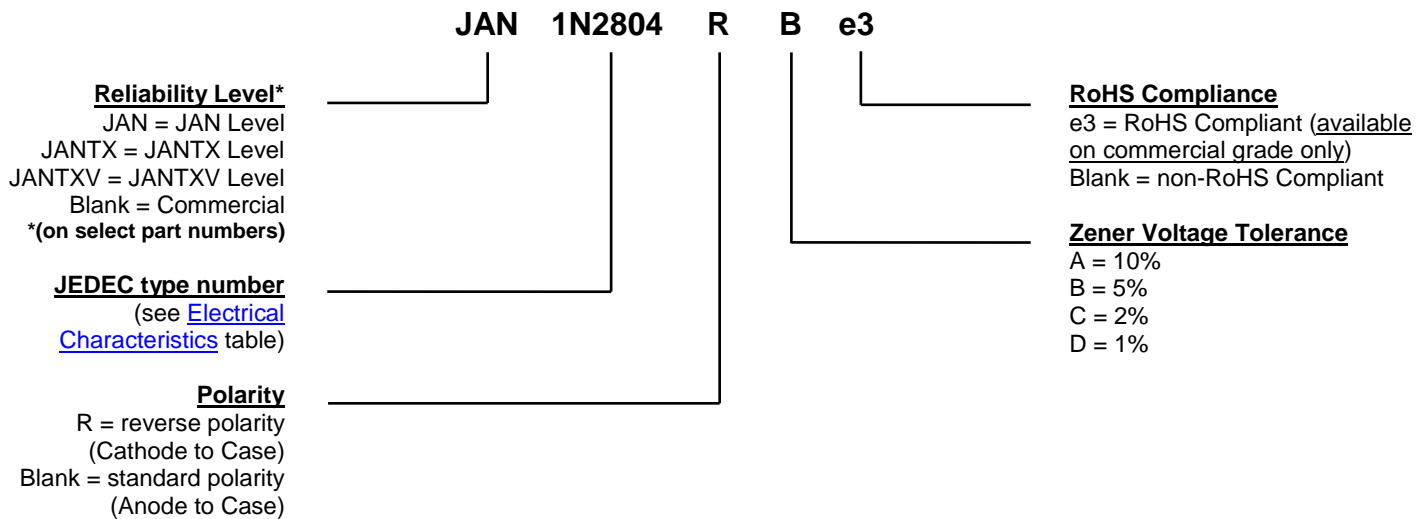
**PART NOMENCLATURE**

**SYMBOLS & DEFINITIONS**

| Symbol                | Definition  |
|-----------------------|---|
| $I_R$                 | Reverse Current: The maximum reverse (leakage) current that will flow at the specified voltage and temperature.   |
| $I_Z, I_{ZT}, I_{ZK}$ | Regulator Current: The dc regulator current ( $I_Z$ ), at a specified test point ( $I_{ZT}$ ), near breakdown knee ( $I_{ZK}$ ).  |
| $I_{ZM}$              | Maximum Regulator (Zener) Current: The maximum rated dc current for the specified power rating.   |
| $V_R$                 | Reverse Voltage: The reverse voltage dc value, no alternating component.  |
| $V_F$                 | Maximum Forward Voltage: The maximum forward voltage the device will exhibit at a specified current.  |
| $V_Z$                 | Zener Voltage: The Zener voltage the device will exhibit at a specified current ( $I_Z$ ) in its breakdown region.  |
| $Z_{ZT}$ or $Z_{ZK}$  | Dynamic Impedance: The small signal impedance of the diode when biased to operate in its breakdown region at a specified rms current modulation (typically 10% of $I_{ZT}$ or $I_{ZK}$ ) and superimposed on $I_{ZT}$ or $I_{ZK}$ respectively. |

\* ELECTRICAL CHARACTERISTICS @  $T_C = 30^\circ\text{C} \pm 3^\circ\text{C}$  unless otherwise noted

| JEDEC<br>TYPE<br>NUMBER<br>(Note 1) | NOMINAL<br>ZENER<br>VOLTAGE<br>$V_Z @ I_{ZT}$ | ZENER<br>TEST<br>CURRENT<br>( $I_{ZT}$ ) | MAXIMUM DYNAMIC<br>IMPEDANCE<br>(NOTE 2) |   | MAX DC ZENER<br>CURRENT<br>( $I_{ZM}$ ) @ 75°C<br>Stud Temp.<br>(Note 3) | TYPICAL<br>TEMPERATURE<br>COEFFICIENT<br>$\alpha_{VZ}$ | MAX**<br>REVERSE<br>CURRENT<br>$I_R @ V_R$ |       |
|-------------------------------------|---|--|--|---|--|--|--|-------|
|                                     |   |  | $Z_{ZT} @ I_{ZT}$                        | $Z_{ZK} @ 1 \text{ mA}$<br>( $I_{ZK}$ ) |  |  | $\mu\text{A}$                              | Volts |
|                                     |   |  | Ohms                                     | Ohms                                    |  |  |  |       |
| †1N4557B                            | 3.9   | 3200                                     | 0.16                                     | 400                                     | 10,000   | -0.050   | 150  | 0.5   |
| †1N4558B                            | 4.3   | 2900                                     | 0.16                                     | 500                                     | 9,000  | -0.035   | 150  | 0.5   |
| †1N4559B                            | 4.7   | 2650                                     | 0.12                                     | 600                                     | 8,000  | $\pm 0.015$  | 100  | 1.0   |
| †1N4560B                            | 5.1   | 2450                                     | 0.12                                     | 650                                     | 7,500  | 0.035  | 20   | 1.0   |
| †1N4561B                            | 5.6   | 2250                                     | 0.12                                     | 900                                     | 7,000  | 0.050  | 20   | 1.0   |
| †1N4562B                            | 6.2   | 2000                                     | 0.14                                     | 1000                                    | 6,500  | 0.055  | 20   | 2.0   |
| 1N4563B                             | 6.8   | 1850                                     | 0.16                                     | 200                                     | 6,650  | 0.053  | 10   | 2.0   |
| 1N4564B                             | 7.5   | 1650                                     | 0.24                                     | 100                                     | 6,050  | 0.057  | 10   | 3.0   |
| †1N2804B                            | 6.8   | 1850                                     | 0.2                                      | 70                                      | 7,000  | 0.057  | 150  | 4.5   |
| †1N2805B                            | 7.5   | 1700                                     | 0.3                                      | 70                                      | 6,360  | 0.067  | 100  | 5.0   |
| †1N2806B                            | 8.2   | 1500                                     | 0.4                                      | 70                                      | 5,800  | 0.070  | 50   | 5.4   |
| †1N2807B                            | 9.1   | 1370                                     | 0.5                                      | 70                                      | 5,240  | 0.075  | 25   | 6.1   |
| †1N2808B                            | 10  | 1200                                     | 0.6                                      | 80                                      | 4,760  | 0.081  | 25   | 6.7   |
| †1N2809B                            | 11  | 1100                                     | 0.8                                      | 80                                      | 4,330  | 0.085  | 10   | 8.4   |
| †1N2810B                            | 12  | 1000                                     | 1.0                                      | 80                                      | 3,970  | 0.079  | 10   | 9.1   |
| †1N2811B                            | 13  | 960                                      | 1.1                                      | 80                                      | 3,750  | 0.080  | 10   | 9.9   |
| 1N2812B                             | 14  | 890                                      | 1.2                                      | 80                                      | 3,400  | 0.070  | 10   | 10.6  |
| †1N2813B                            | 15  | 830                                      | 1.4                                      | 80                                      | 3,170  | 0.082  | 10   | 11.4  |
| †1N2814B                            | 16  | 780                                      | 1.6                                      | 80                                      | 2,970  | 0.083  | 10   | 12.2  |
| 1N2815B                             | 17  | 740                                      | 1.8                                      | 80                                      | 2,750  | 0.075  | 10   | 13.0  |
| †1N2816B                            | 18  | 700                                      | 2.0                                      | 80                                      | 2,640  | 0.085  | 10   | 13.7  |
| 1N2817B                             | 19  | 660                                      | 2.2                                      | 80                                      | 2,450  | 0.075  | 10   | 14.4  |
| †1N2818B                            | 20  | 630                                      | 2.4                                      | 80                                      | 2,380  | 0.086  | 10   | 15.2  |
| †1N2819B                            | 22  | 570                                      | 2.5                                      | 80                                      | 2,160  | 0.087  | 10   | 16.7  |
| †1N2820B                            | 24  | 520                                      | 2.6                                      | 80                                      | 1,980  | 0.088  | 10   | 18.2  |
| 1N2821B                             | 25  | 500                                      | 2.7                                      | 80                                      | 1,850  | 0.080  | 10   | 19.0  |
| †1N2822B                            | 27  | 460                                      | 2.8                                      | 90                                      | 1,760  | 0.090  | 10   | 20.6  |
| †1N2823B                            | 30  | 420                                      | 3.0                                      | 90                                      | 1,590  | 0.091  | 10   | 22.8  |
| †1N2824B                            | 33  | 380                                      | 3.2                                      | 90                                      | 1,440  | 0.092  | 10   | 25.1  |
| †1N2825B                            | 36  | 350                                      | 3.5                                      | 90                                      | 1,320  | 0.093  | 10   | 27.4  |
| †1N2826B                            | 39  | 320                                      | 4.0                                      | 90                                      | 1,220  | 0.094  | 10   | 29.7  |
| †1N2827B                            | 43  | 290                                      | 4.5                                      | 90                                      | 1,000  | 0.095  | 10   | 32.7  |
| 1N2828B                             | 45  | 280                                      | 4.5                                      | 100                                     | 1,030  | 0.090  | 10   | 34.2  |
| †1N2829B                            | 47  | 270                                      | 5.0                                      | 100                                     | 1,020  | 0.095  | 10   | 35.8  |
| 1N2830B                             | 50  | 250                                      | 5.0                                      | 100                                     | 935  | 0.090  | 10   | 38.0  |
| †1N2831B                            | 51  | 245                                      | 5.2                                      | 100                                     | 930  | 0.096  | 10   | 38.8  |
| †1N2832B                            | 56  | 220                                      | 6  | 110                                     | 850  | 0.096  | 10   | 42.6  |
| †1N2833B                            | 62  | 200                                      | 7  | 120                                     | 770  | 0.097  | 10   | 47.1  |
| †1N2834B                            | 68  | 180                                      | 8  | 140                                     | 700  | 0.097  | 10   | 51.7  |
| †1N2835B                            | 75  | 170                                      | 9  | 150                                     | 640  | 0.098  | 10   | 56.0  |
| †1N2836B                            | 82  | 150                                      | 11                                       | 160                                     | 580  | 0.098  | 10   | 62.2  |
| †1N2837B                            | 91  | 140                                      | 15                                       | 180                                     | 530  | 0.099  | 10   | 69.2  |
| †1N2838B                            | 100   | 120                                      | 20                                       | 200                                     | 480  | 0.100  | 10   | 76.0  |
| 1N2839B                             | 105   | 120                                      | 25                                       | 210                                     | 430  | 0.090  | 10   | 79.8  |
| †1N2840B                            | 110   | 110                                      | 30                                       | 220                                     | 430  | 0.100  | 10   | 83.6  |
| †1N2841B                            | 120   | 100                                      | 40                                       | 240                                     | 400  | 0.100  | 10   | 91.2  |
| †1N2842B                            | 130   | 95                                       | 50                                       | 275                                     | 370  | 0.100  | 10   | 98.8  |
| †1N2843B                            | 150   | 85                                       | 75                                       | 400                                     | 320  | 0.100  | 10   | 114.0 |
| †1N2844B                            | 160   | 80                                       | 80                                       | 450                                     | 300  | 0.100  | 10   | 121.6 |
| †1N2845B                            | 180   | 68                                       | 90                                       | 525                                     | 260  | 0.100  | 10   | 136.8 |
| †1N2846B                            | 200   | 65                                       | 100                                      | 600                                     | 240  | 0.100  | 10   | 152.0 |

\* JEDEC Registered Data. \*\*Not JEDEC Data. † Have JAN, JANTX and JANTXV Qualifications to MIL-PRF-19500/114

See notes on following page.

**NOTES:**

1. The JEDEC type numbers shown (B suffix) have a +/- 5 % tolerance on nominal Zener voltage.
2. Zener voltage ( $V_Z$ ) is measured with junction in thermal equilibrium with 30 °C base temperature. The test currents ( $I_{ZT}$ ) have been selected so that at nominal voltages the dissipation is a constant 12.5 watts. This results in a nominal junction temperature rise of 18.75 °C.
3. The Zener impedance is derived from the 60 cycle ac voltage, which results when an ac current having an rms value equal to 10% of the dc Zener current ( $I_{ZT}$  or  $I_{ZK}$ ) is superimposed on  $I_{ZT}$  or  $I_{ZK}$ . Zener impedance is measured at 2 points to ensure a sharp knee on the breakdown curve and to eliminate unstable units. A curve showing the variation of Zener impedance vs. Zener current for six representative types is shown in [Figure 3](#). Also see [MicroNote 202](#) for further information.
4. The values of  $I_{ZM}$  are calculated for a +/- 5 % tolerance on nominal Zener voltage. Allowance has been made for the rise in Zener voltage above  $V_{ZT}$  that results from Zener impedance and the increase in junction temperature as power dissipation approaches 50 watts. In the case of individual diodes,  $I_{ZM}$  is that value of current that results in a dissipation of 50 watts.

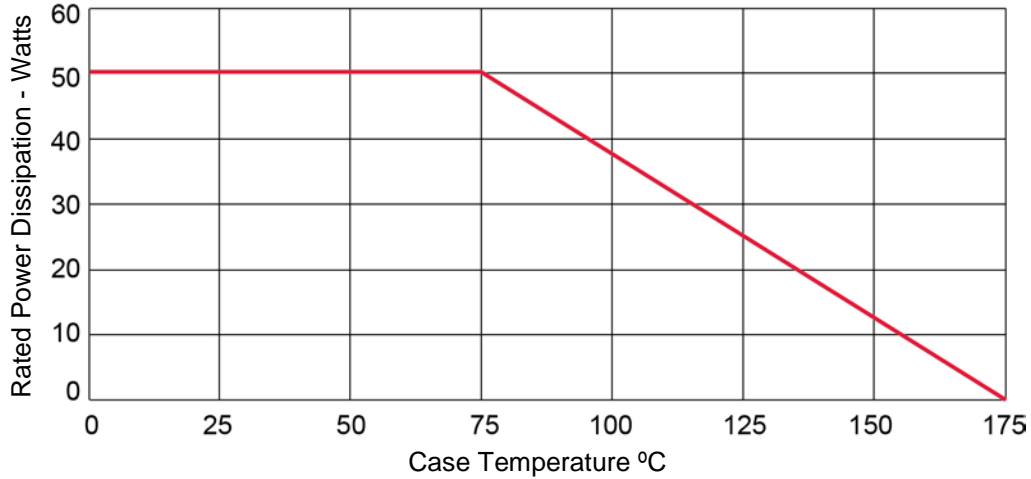
**GRAPHS**

**FIGURE 1**  
Power Derating Curve

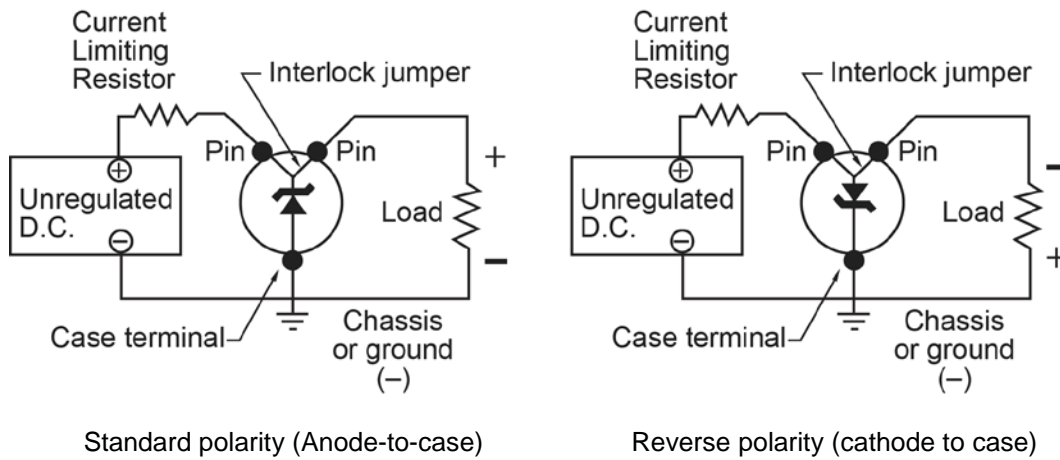

**FIGURE 2**  
Typical circuit connections for anode-to-case and cathode-to-case polarities

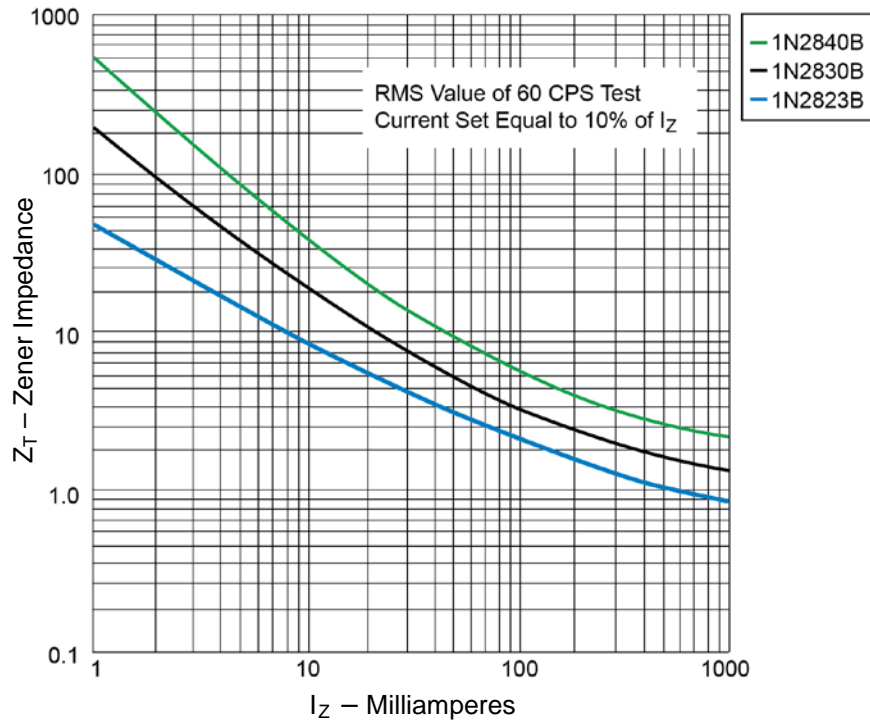
**GRAPHS**

**FIGURE 3**

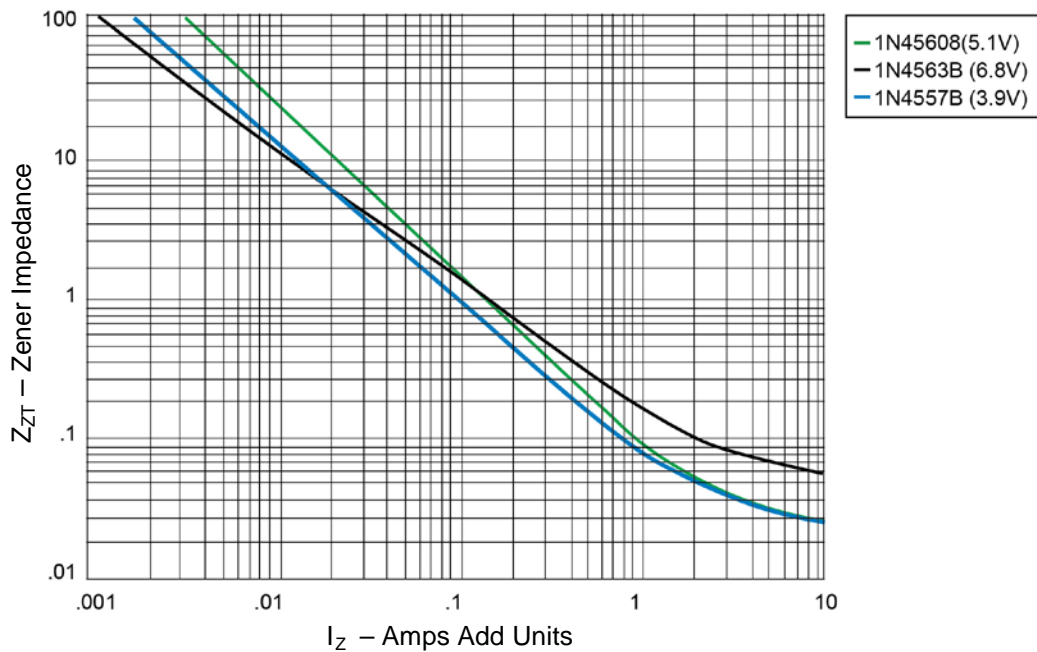
Typical Zener Impedance vs Zener Current for Types Shown

**FIGURE 4**

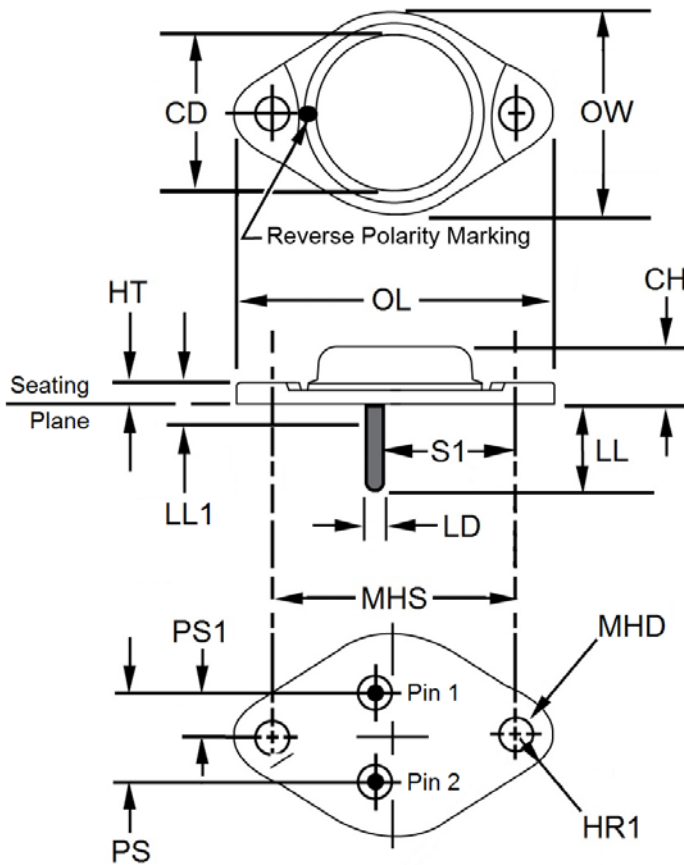
Typical Zener Impedance vs Zener Current for Types Shown

**PACKAGE DIMENSIONS**



| Ltr | Dimensions |       |             |       | Notes |
|-----|------------|-------|-------------|-------|-------|
|     | Inches     |       | Millimeters |       |       |
|     | Min        | Max   | Min         | Max   |       |
| CD  | -          | 0.875 | -           | 22.23 |       |
| CH  | 0.270      | 0.380 | 6.86        | 9.65  |       |
| HR  | 0.495      | 0.525 | 12.57       | 13.34 |       |
| HR1 | 0.131      | 0.188 | 3.33        | 4.78  |       |
| HT  | 0.060      | 0.135 | 1.52        | 3.43  |       |
| LD  | 0.048      | 0.053 | 1.22        | 1.35  |       |
| LL  | 0.312      | 0.500 | 7.92        | 12.70 |       |
| L1  | -          | 0.050 | -           | 1.27  |       |
| MHD | 0.151      | 0.165 | 3.84        | 4.19  |       |
| MHS | 1.177      | 1.197 | 29.90       | 30.40 |       |
| OL  | 1.520      | 1.540 | 38.61       | 39.12 |       |
| OW  | 0.900      | 1.10  | 22.86       | 27.94 |       |
| PS  | 0.420      | 0.440 | 10.67       | 11.18 | 2     |
| PS1 | 0.205      | 0.225 | 5.21        | 5.72  | 2     |
| S1  | 0.655      | 0.675 | 16.64       | 17.15 |       |

**NOTES:**

1. Dimensions are in inches. Millimeters are given for general information only.
2. These dimensions should be measured at points 0.050 inch (1.27 mm) +0.005 inch (+0.13 mm) –0.000 inch (–0.00 mm) below seating plane.
3. The seating plane of the header shall be flat within 0.001 inch (0.03 mm) concave to 0.004 inch (0.10 mm) convex 0.001 inch (0.03 mm) concave to 0.006 inch (0.15 mm) convex overall.
4. Pins 1 and 2 are internally connected with an internal jumper.
5. Devices with RB suffix (reverse polarity) have the cathode internally connected to the case.
6. In accordance with ASME Y14.5M, diameters are equivalent to  $\Phi$ x symbology.

## Looking for pricing, stock, or lifecycle information?

Click below to explore more details on WIN SOURCE:

-  [View 1N2843A on WIN SOURCE](#)
-  [Microsemi Corporation](#) Information

## Optimize Your Supply Chain with WIN SOURCE Solutions

-  Global Sourcing Solution
-  Obsolete Management
-  Cost Control Management
-  Shortage Management
-  Alternative Solution
-  Excess Inventory Management