



NPN Darlington Power Silicon Transistor

Qualified per MIL-PRF-19500/504

*Qualified Levels:
JAN, JANTX, and
JANTXV*

DESCRIPTION

This high speed NPN transistor is rated at 20 amps and is military qualified up to a JANTXV level. This TO-204AA isolated package features a 180 degree lead orientation.

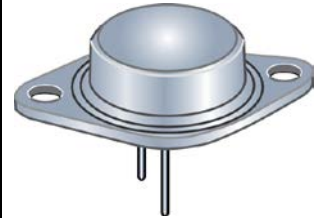

Important: For the latest information, visit our website <http://www.microsemi.com>.

FEATURES

- JEDEC registered 2N6283 and 2N6284.
- JAN, JANTX, and JANTXV qualifications are available per MIL-PRF-19500/504.
- RoHS compliant versions available (commercial grade only).

**TO-204AA (TO-3)
Package**

APPLICATIONS / BENEFITS

- Military, space and other high reliability applications.
- High frequency response.
- TO-204AA case with isolated terminals.

MAXIMUM RATINGS @ T_C = +25 °C unless otherwise noted

Parameters/Test Conditions	Symbol	Value	Unit	
Junction and Storage Temperature	T _J and T _{STG}	-65 to +200	°C	
Thermal Resistance Junction-to-Case	R _{θJC}	0.857	°C/W	
Collector Current	I _C	20	A	
Collector-Emitter Voltage	V _{CEO}	2N6283	80	V
		2N6284	100	
Collector-Base Voltage	V _{CBO}	2N6283	80	V
		2N6284	100	
Emitter-Base Voltage	V _{EBO}	7	V	
Total Power Dissipation	P _T	@ T _C = +25 °C ⁽¹⁾	175	W
		@ T _C = +100 °C ⁽²⁾	87.5	

- Notes:**
1. Derate linearly 1.17 W/°C above T_C > +25 °C. (See [Figure 1](#))
 2. Derate linearly 0.875 W/°C above T_C > +100 °C. (See [Figure 1](#))

MSC – Lawrence
6 Lake Street,
Lawrence, MA 01841
1-800-446-1158
(978) 620-2600
Fax: (978) 689-0803

MSC – Ireland
Gort Road Business Park,
Ennis, Co. Clare, Ireland
Tel: +353 (0) 65 6840044
Fax: +353 (0) 65 6822298

Website:
www.microsemi.com

MECHANICAL and PACKAGING

- CASE: Industry standard TO-204AA (TO-3), hermetically sealed, 0.040 inch diameter pins
- FINISH: Solder dipped tin-lead over nickel plated alloy 52 or RoHS compliant matte-tin plating. Solderable per MIL-STD-750 method 2026.
- POLARITY: NPN (see [schematic](#))
- MOUNTING HARDWARE: Consult factory for optional insulator and sheet metal screws
- WEIGHT: Approximately 15 grams
- See [package dimensions](#) on last page.

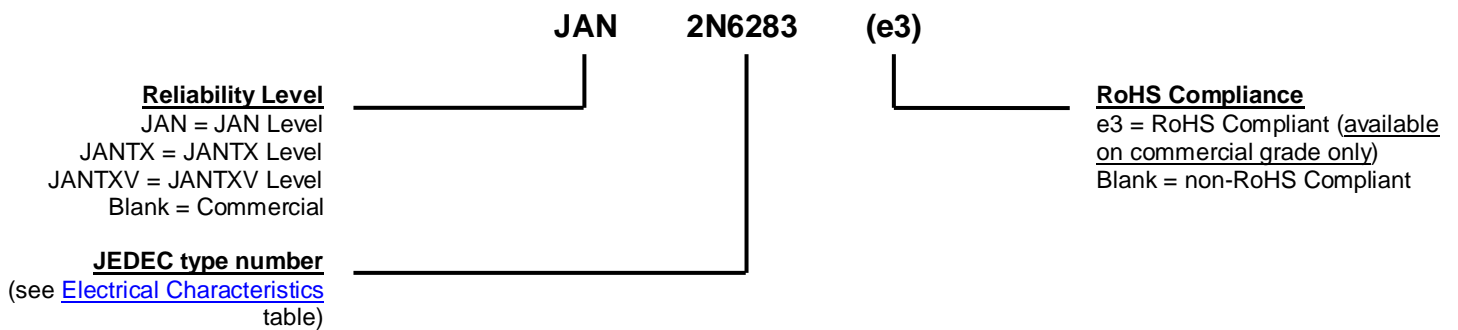
PART NOMENCLATURE

SYMBOLS & DEFINITIONS

Symbol	Definition
I_B	Base current: The value of the dc current into the base terminal.
I_C	Collector current: The value of the dc current into the collector terminal.
I_E	Emitter current: The value of the dc current into the emitter terminal.
T_C	Case temperature: The temperature measured at a specified location on the case of a device.
V_{CB}	Collector-base voltage: The dc voltage between the collector and the base.
V_{CBO}	Collector-base voltage, base open: The voltage between the collector and base terminals when the emitter terminal is open-circuited.
V_{CC}	Collector-supply voltage: The supply voltage applied to a circuit connected to the collector.
V_{CE}	Collector-emitter voltage: The dc voltage between the collector and the emitter.
V_{CEO}	Collector-emitter voltage, base open: The voltage between the collector and the emitter terminals when the base terminal is open-circuited.
V_{EB}	Emitter-base voltage: The dc voltage between the emitter and the base
V_{EBO}	Emitter-base voltage, collector open: The voltage between the emitter and base terminals with the collector terminal open-circuited.

ELECTRICAL CHARACTERISTICS @ $T_A = +25^\circ\text{C}$ unless otherwise noted

Characteristics		Symbol	Min.	Max.	Unit
OFF CHARACTERISTICS					
Collector-Emitter Breakdown Voltage $I_C = 100\text{ mA}$	2N6283 2N6284	$V_{(BR)CEO}$	80 100		V
Collector-Emitter Cutoff Current $V_{CE} = 40\text{ V}$ $V_{CE} = 50\text{ V}$	2N6283 2N6284	I_{CEO}		1.0 1.0	mA
Collector-Emitter Cutoff Current $V_{CE} = 80\text{ V}, V_{BE} = 1.5\text{ V}$ $V_{CE} = 100\text{ V}, V_{BE} = 1.5\text{ V}$	2N6283 2N6284	I_{CEX}		0.01 0.01	mA
Emitter-Base Cutoff Current $V_{EB} = 7.0\text{ V}$		I_{EBO}		2.5	mA

ON CHARACTERISTICS

Forward-Current Transfer Ratio $I_C = 1.0\text{ A}, V_{CE} = 3.0\text{ V}$ $I_C = 10\text{ A}, V_{CE} = 3.0\text{ V}$ $I_C = 20\text{ A}, V_{CE} = 3.0\text{ V}$		h_{FE}	1,500 1,250 500	18,000	
Collector-Emitter Saturation Voltage $I_C = 20\text{ A}, I_B = 200\text{ mA}$ $I_C = 10\text{ A}, I_B = 40\text{ mA}$		$V_{CE(sat)}$		3.0 2.0	V
Base-Emitter Saturation Voltage $I_C = 20\text{ A}, I_B = 200\text{ mA}$		$V_{BE(sat)}$		4.0	V
Base-Emitter Voltage Non-saturated $V_{CE} = 3.0\text{ V}, I_C = 10\text{ A}$		V_{BE}		2.8	V

DYNAMIC CHARACTERISTICS

Common Emitter Small-Signal Short-Circuit Forward Current Transfer Ratio $I_C = 10\text{ A}, V_{CE} = 3.0\text{ V}, f = 1\text{ kHz}$		h_{fe}	700		
Magnitude of Common Emitter Small-Signal Short-Circuit Forward Current Transfer Ratio $I_C = 10\text{ A}, V_{CE} = 3.0\text{ V}, f = 1\text{ MHz}$		$ h_{fe} $	8	80	
Output Capacitance $V_{CB} = 10\text{ V}, I_E = 0, f = 100\text{ kHz} \leq f \leq 1\text{ MHz}$		C_{obo}		350	pF

ELECTRICAL CHARACTERISTICS @ $T_C = 25\text{ }^\circ\text{C}$ unless otherwise noted. (continued)
SWITCHING CHARACTERISTICS

Turn-On Time $V_{CC} = 30\text{ V}$, $I_C = 10\text{ A}$; $I_B = 40\text{ mA}$	t_{on}		2.0	μs
Turn-Off Time $V_{CC} = 30\text{ V}$, $I_C = 10\text{ A}$; $I_{B1} = I_{B2} = 40\text{ mA}$	t_{off}		10	μs

SAFE OPERATING AREA (See [Figures 1 and 2](#) below and [MIL-STD-750, Test Method 3053](#))
DC Tests
 $T_C = +25\text{ }^\circ\text{C}$, $+10\text{ }^\circ\text{C}$, $-0\text{ }^\circ\text{C}$, $t \geq 1\text{ second}$, 1 Cycle

Test 1
 $V_{CE} = 8.75\text{ V}$, $I_C = 20\text{ A}$
Test 2
 $V_{CE} = 30\text{ V}$, $I_C = 5.8\text{ A}$
Test 3
 $V_{CE} = 80\text{ V}$, $I_C = 100\text{ mA}$ (2N6283)

 $V_{CE} = 100\text{ V}$, $I_C = 100\text{ mA}$ (2N6284)

SAFE OPERATING AREA

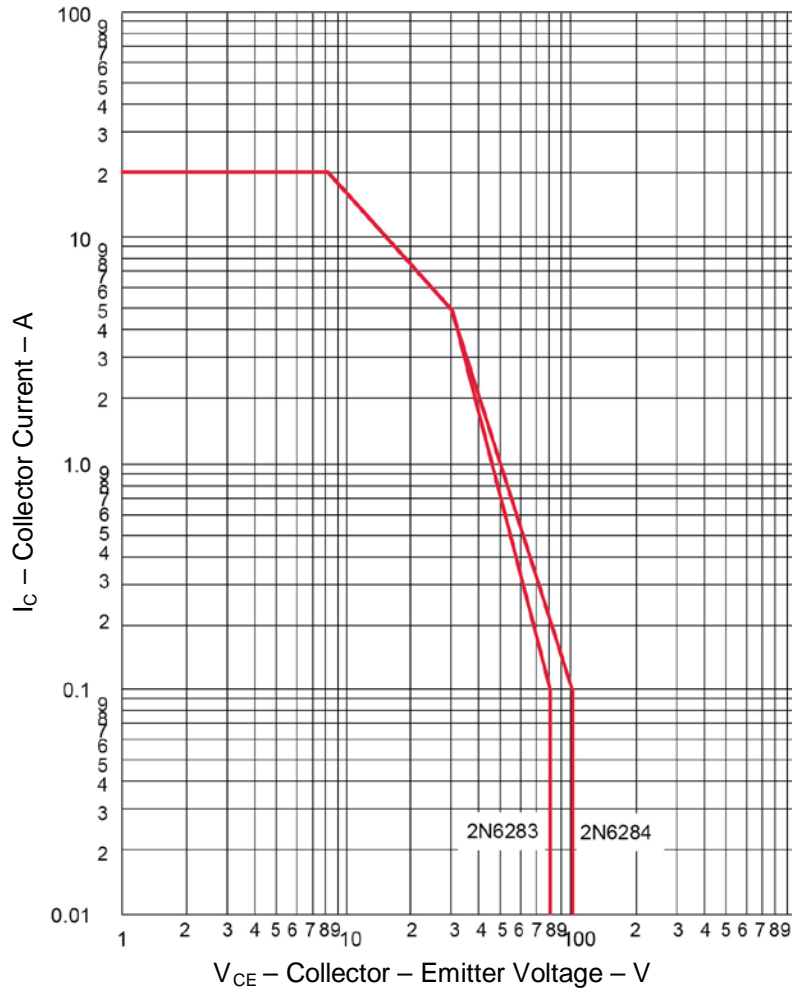

FIGURE 1
Maximum Safe Operating Area
 (continuous dc)

SAFE OPERATING AREA (continued)

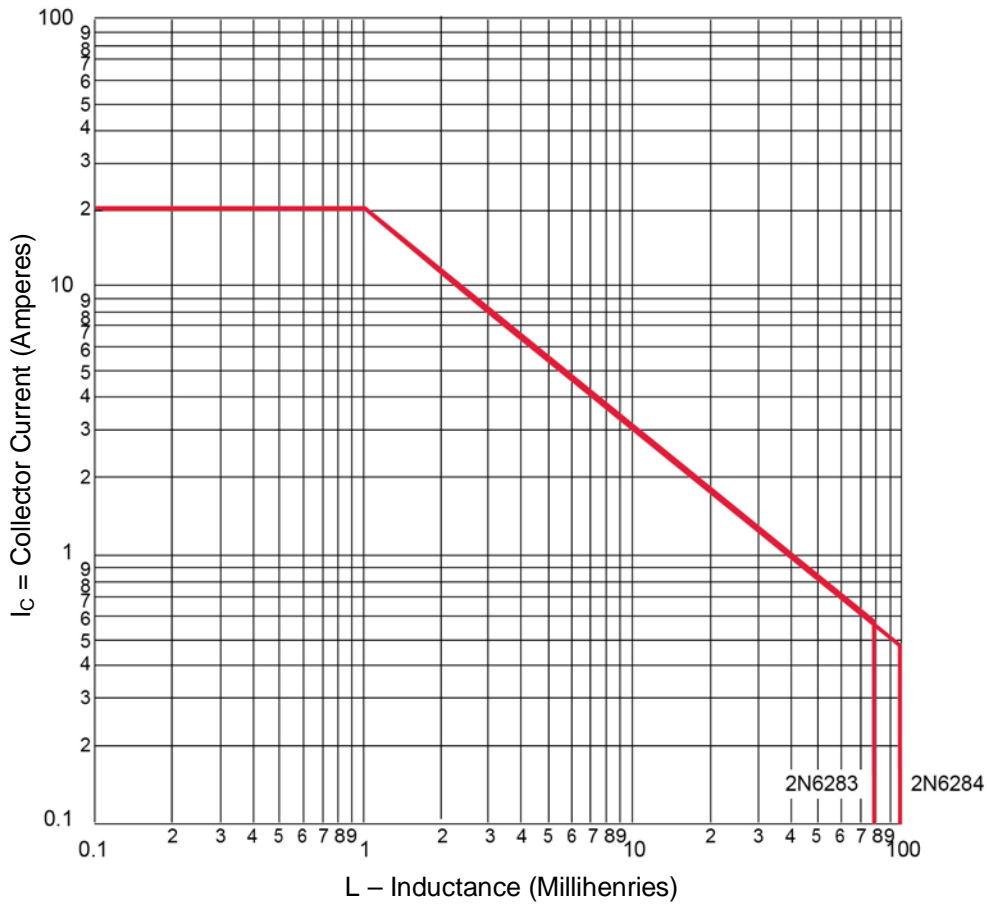

FIGURE 2
Safe Operating Area for Switching Between Saturation and Cutoff
 (unclamped inductive load)

GRAPHS

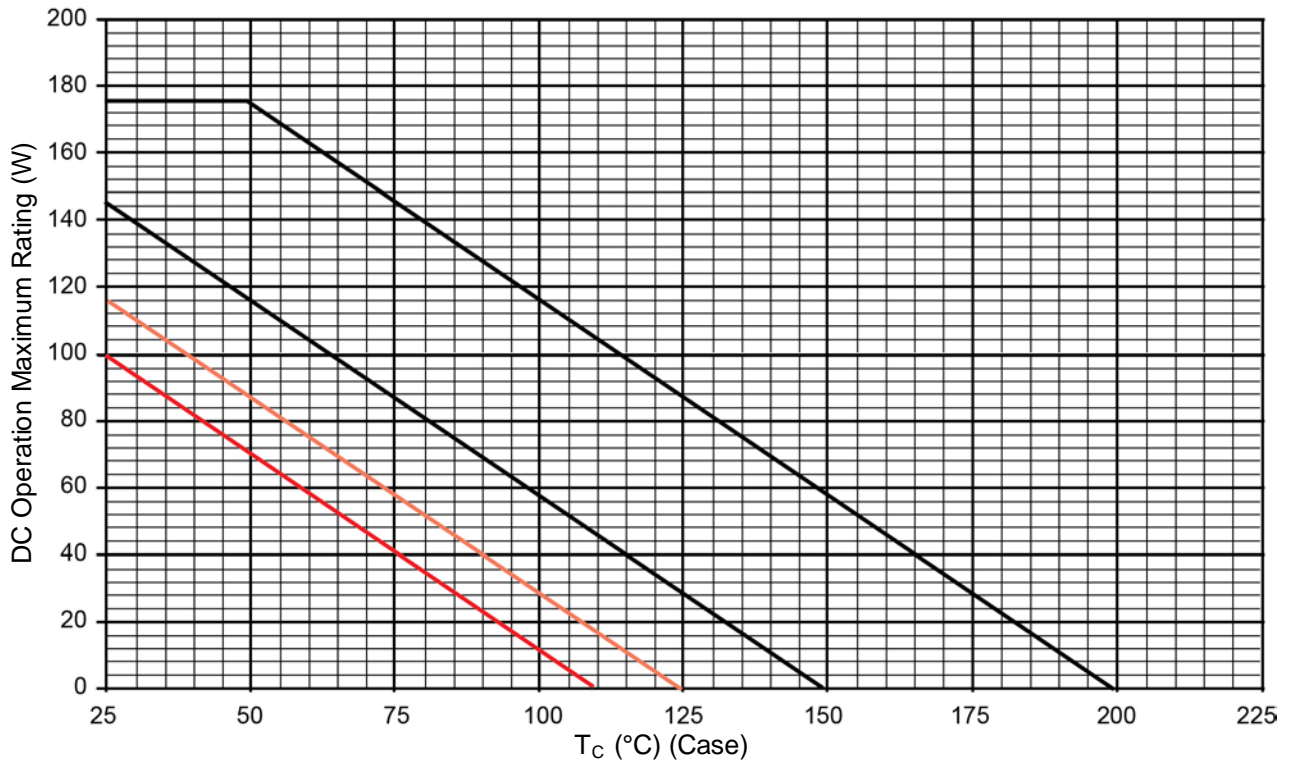
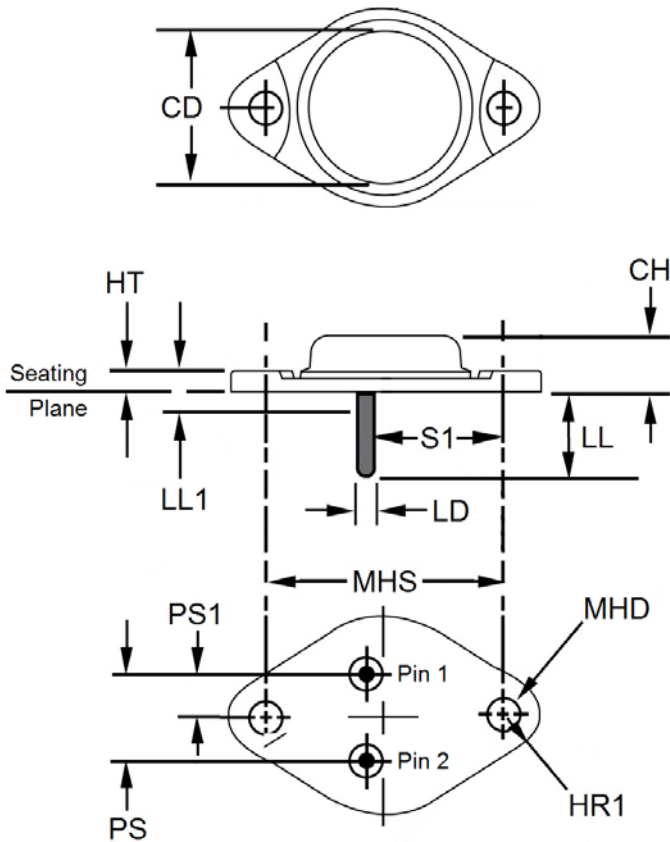

FIGURE 1
Temperature – Power Derating Curve

PACKAGE DIMENSIONS

Ltr	Dimensions				Notes
	Inches		Millimeters		
	Min	Max	Min	Max	
CD	-	0.875	-	22.23	3
CH	0.250	0.328	6.35	8.33	
HR	0.495	0.525	12.57	13.34	
HR1	0.131	0.188	3.33	4.78	6
HT	0.060	0.135	1.52	3.43	
LD	0.038	0.043	0.97	1.09	4, 5, 9
LL	0.312	0.500	7.92	12.70	4, 5, 9
LL1	-	0.050	-	1.27	5, 9
MHD	0.151	0.161	3.84	4.09	7
MHS	1.177	1.197	29.90	30.40	
PS	0.420	0.440	10.67	11.18	
PS1	0.205	0.225	5.21	5.72	5
S1	0.655	0.675	16.64	17.15	

NOTES:

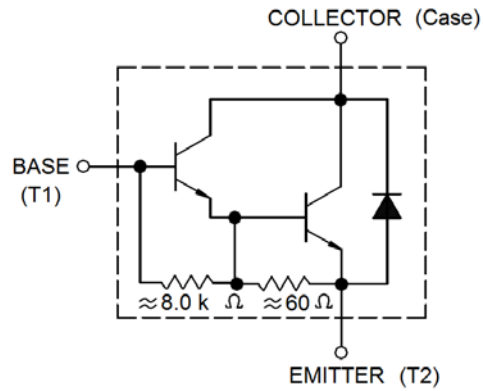

1. Dimensions are in inches. Millimeters are given for information only.
2. Millimeters are given for information only.
3. Body contour is optional within zone defined by CD.
4. These dimensions shall be measured at points .050 inch (1.27 mm) to .055 inch (1.40 mm) below seating plane. When gauge is not used, measurement shall be made at seating plane.
5. Both terminals.
6. At both ends.
7. Two holes.
8. The collector shall be electrically connected to the case.
9. LD applies between L1 and LL. Lead diameter shall not exceed twice LD within L1.
10. The seating plane of the header shall be flat within .001 inch (0.03 mm), concave to .004 inch (0.10 mm), convex inside a .930 inch (23.62 mm) diameter circle on the center of the header, and flat within .001 inch (0.03 mm) concave to .006 inch (0.15 mm), convex overall.
11. In accordance with ASME Y14.5M, diameters are equivalent to Φ x symbology.

SCHEMATIC



Looking for pricing, stock, or lifecycle information?

Click below to explore more details on WIN SOURCE:

-  [View JAN2N6283 on WIN SOURCE](#)
-  [Microsemi Corporation](#) Information

Optimize Your Supply Chain with WIN SOURCE Solutions

-  Global Sourcing Solution
-  Obsolete Management
-  Cost Control Management
-  Shortage Management
-  Alternative Solution
-  Excess Inventory Management