

2SA2057

Silicon PNP epitaxial planar type

Power supply for audio & visual equipments

such as TVs and VCRs

Industrial equipments such as DC-DC converters

■ Features

- High speed switching (t_{stg} : storage time/ t_f : fall time is short)
- Low collector-emitter saturation voltage $V_{CE(sat)}$
- Superior forward current transfer ratio h_{FE} linearity
- TO-220D built-in: Excellent package with withstand voltage 5 kV guaranteed

■ Absolute Maximum Ratings $T_C = 25^\circ\text{C}$

Parameter	Symbol	Rating	Unit
Collector-base voltage (Emitter open)	V_{CBO}	-60	V
Collector-emitter voltage (Base open)	V_{CEO}	-60	V
Emitter-base voltage (Collector open)	V_{EBO}	-6	V
Collector current	I_C	-3	A
Peak collector current *	I_{CP}	-6	A
Collector power dissipation	P_C	20	W
	$T_a = 25^\circ\text{C}$	2.0	
Junction temperature	T_j	150	$^\circ\text{C}$
Storage temperature	T_{stg}	-55 to +150	$^\circ\text{C}$

Note) *: Non-repetitive peak collector current

■ Electrical Characteristics $T_C = 25^\circ\text{C} \pm 3^\circ\text{C}$

Parameter	Symbol	Conditions	Min	Typ	Max	Unit
Collector-emitter voltage (Base open)	V_{CEO}	$I_C = -10 \text{ mA}$, $I_B = 0$	-60			V
Collector-base cutoff current (Emitter open)	I_{CBO}	$V_{CB} = -60 \text{ V}$, $I_E = 0$			-100	μA
Collector-emitter cutoff current (Base open)	I_{CEO}	$V_{CE} = -60 \text{ V}$, $I_B = 0$			-100	μA
Emitter-base cutoff current (Collector open)	I_{EBO}	$V_{EB} = -6 \text{ V}$, $I_C = 0$			-1	mA
Forward current transfer ratio	h_{FE1} *	$V_{CE} = -4 \text{ V}$, $I_C = -1 \text{ A}$	120		320	—
	h_{FE2}	$V_{CE} = -4 \text{ V}$, $I_C = -3 \text{ A}$	40			
Collector-emitter saturation voltage	$V_{CE(sat)}$	$I_C = -3 \text{ A}$, $I_B = -0.375 \text{ A}$			-0.5	V
Transition frequency	f_T	$V_{CE} = -10 \text{ V}$, $I_C = -0.1 \text{ A}$, $f = 10 \text{ MHz}$		90		MHz
Turn-on time	t_{on}	$I_C = -1 \text{ A}$, Resistance loaded		0.15	0.30	μs
Storage time	t_{stg}	$I_{B1} = -0.1 \text{ A}$, $I_{B2} = 0.1 \text{ A}$		0.4	0.7	μs
Fall time	t_f	$V_{CC} = 50 \text{ V}$		0.10	0.15	μs

Note) 1. Measuring methods are based on JAPANESE INDUSTRIAL STANDARD JIS C 7030 measuring methods for transistors.

2. *: Rank classification

Rank	Q	P
h_{FE1}	120 to 250	160 to 320

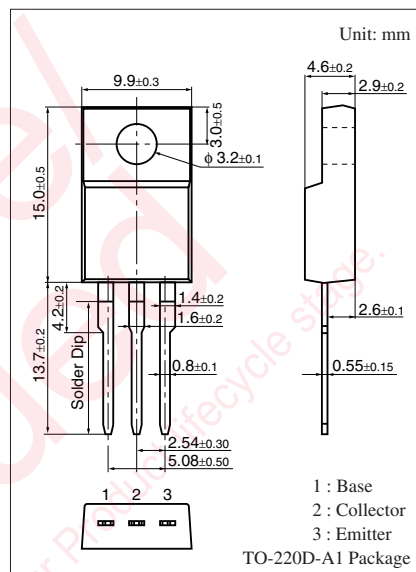

Internal Connection

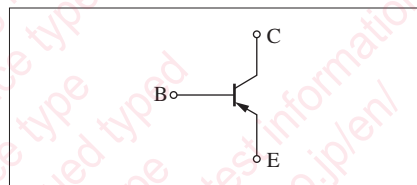

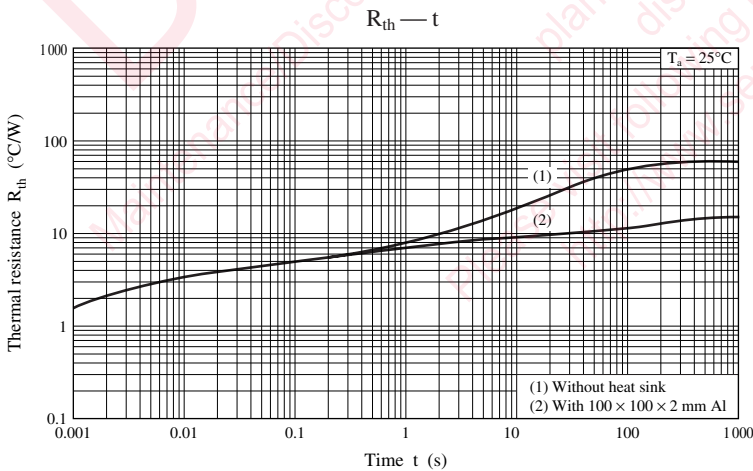
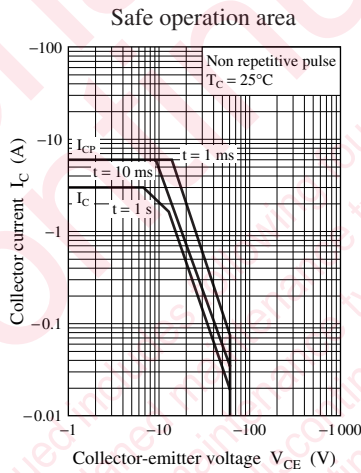
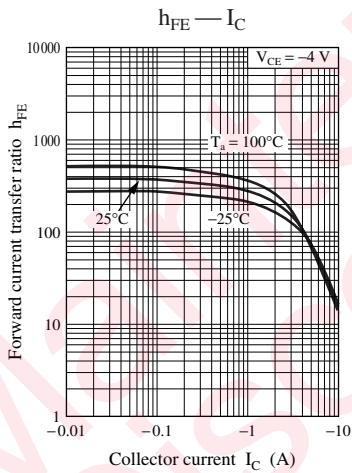
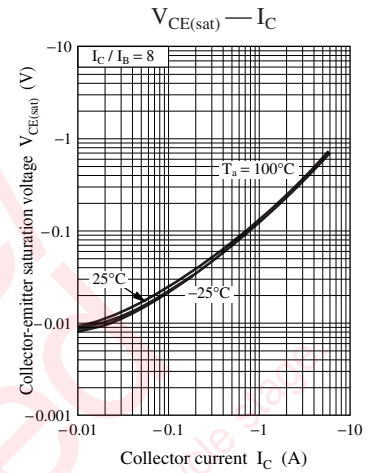
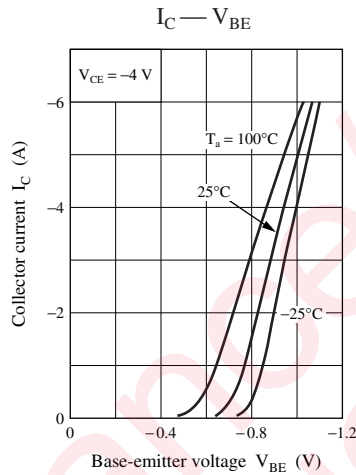
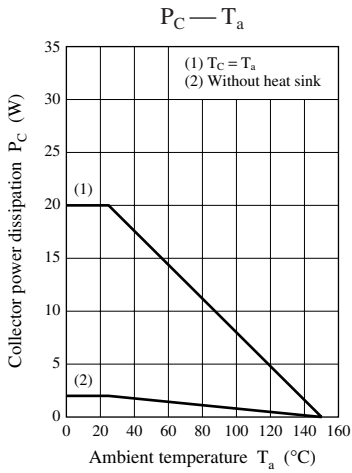

utions in using the technical information and scribed in this book

s book is to be exported or provided to non-residents, the laws and
rd to security export control, must be observed.

ly to show the main characteristics and application circuit examples
l property right or other right owned by our company or any other
any as to the infringement upon any such right owned by any other
rmation described in this book.

standard applications or general electronic equipment (such as office
and household appliances).

ng applications:

biles, traffic control equipment, combustion equipment, life support
reliability are required, or if the failure or malfunction of the prod-

k are subject to change without notice for modification and/or im-
use of the products, therefore, ask for the most up-to-date Product
atisfy your requirements.

bsolute maximum rating and the guaranteed operating conditions
(.). Especially, please be careful not to exceed the range of absolute
r-off and mode-switching. Otherwise, we will not be liable for any

take into the consideration of incidence of break down and failure
n the systems such as redundant design, arresting the spread of fire
al injury, fire, social damages, for example, by using the products.

own and characteristics change due to external factors (ESD, EOS,
mounting or at customer's process. When using products for which
shelf life and the elapsed time since first opening the packages.

ly or partially, without the prior written permission of Matsushita

Looking for pricing, stock, or lifecycle information?

Click below to explore more details on WIN SOURCE:

 [View 2SA20570P on WIN SOURCE](#)

 [Panasonic Information](#)

Optimize Your Supply Chain with WIN SOURCE Solutions

-  Global Sourcing Solution
-  Obsolete Management
-  Cost Control Management
-  Shortage Management
-  Alternative Solution
-  Excess Inventory Management