

2SD0946A, 2SD0946B

Silicon NPN epitaxial planar type darlington

For low-frequency amplification

■ Features

- Forward current transfer ratio h_{FE} is designed high, which is appropriate to the driver circuit of motors and printer hammer.
- A shunt resistor is omitted from the driver.

■ Absolute Maximum Ratings $T_a = 25^\circ\text{C}$

Parameter	Symbol	Rating	Unit
Collector-base voltage (Emitter open)	2SD0946A	60	V
	2SD0946B	100	
Collector-emitter voltage (Base open)	2SD0946A	50	V
	2SD0946B	80	
Emitter-base voltage (Collector open)	V_{EBO}	5	V
Collector current	I_C	1	A
Peak collector current	I_{CP}	1.5	A
Collector power dissipation	P_C	1.2	W
Junction temperature	T_j	150	$^\circ\text{C}$
Storage temperature	T_{stg}	-55 to +150	$^\circ\text{C}$

■ Package

- Code
TO-126B-A1
- Pin Name
1: Emitter
2: Collector
3: Base

■ Internal Connection

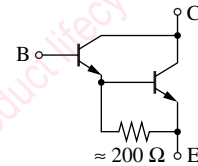

■ Electrical Characteristics $T_a = 25^\circ\text{C} \pm 3^\circ\text{C}$

Parameter	Symbol	Conditions	Min	Typ	Max	Unit
Collector-base voltage (Emitter open)	2SD0946A	$I_C = 100 \mu\text{A}, I_E = 0$	60			V
	2SD0946B		100			
Collector-emitter voltage (Base open)	2SD0946A	$I_C = 1 \text{ mA}, I_B = 0$	50			V
	2SD0946B		80			
Emitter-base voltage (Collector open)	V_{EBO}	$I_E = 100 \mu\text{A}, I_C = 0$	5			V
Collector-base cutoff current (Emitter open)	I_{CBO}	$V_{CB} = 25 \text{ V}, I_E = 0$			0.1	μA
Emitter-base cutoff current (Collector open)	I_{EBO}	$V_{EB} = 4 \text{ V}, I_C = 0$			0.1	μA
Forward current transfer ratio *1, 2	h_{FE}	$V_{CE} = 10 \text{ V}, I_C = 1 \text{ A}$	4000		40000	—
Collector-emitter saturation voltage *1	$V_{CE(sat)}$	$I_C = 1 \text{ A}, I_B = 1 \text{ mA}$			1.8	V
Base-emitter saturation voltage *1	$V_{BE(sat)}$	$I_C = 1 \text{ A}, I_B = 1 \text{ mA}$			2.2	V
Transition frequency	f_T	$V_{CB} = 10 \text{ V}, I_E = -50 \text{ mA}, f = 200 \text{ MHz}$		150		MHz

Note) 1. Measuring methods are based on JAPANESE INDUSTRIAL STANDARD JIS C 7030 measuring methods for transistors.

2. *1: Pulse measurement

*2: Rank classification

Rank	Q	R	S
h_{FE}	4000 to 10000	8000 to 20000	16000 to 40000

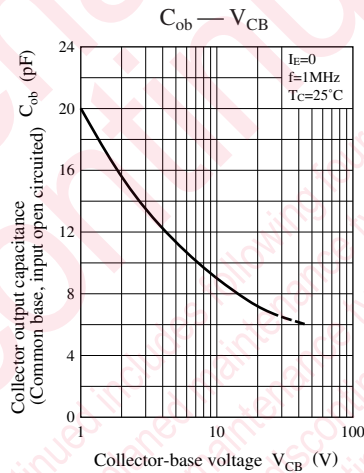
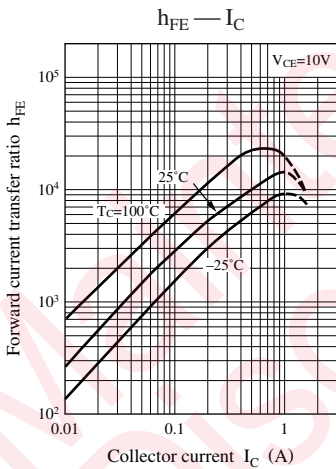
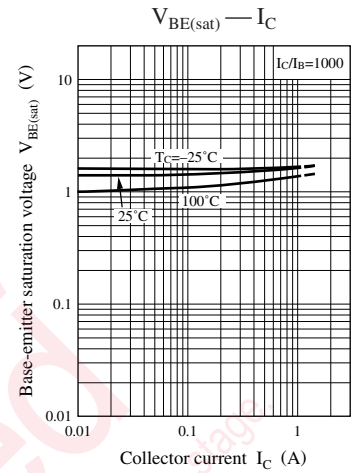
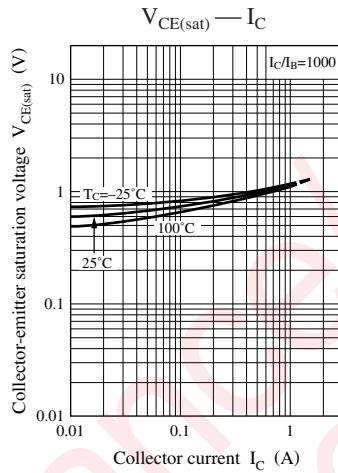
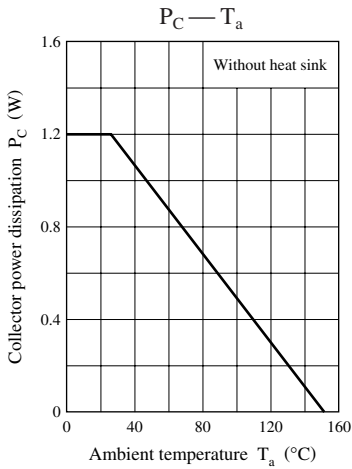

TO-126B-A1

Unit: mm

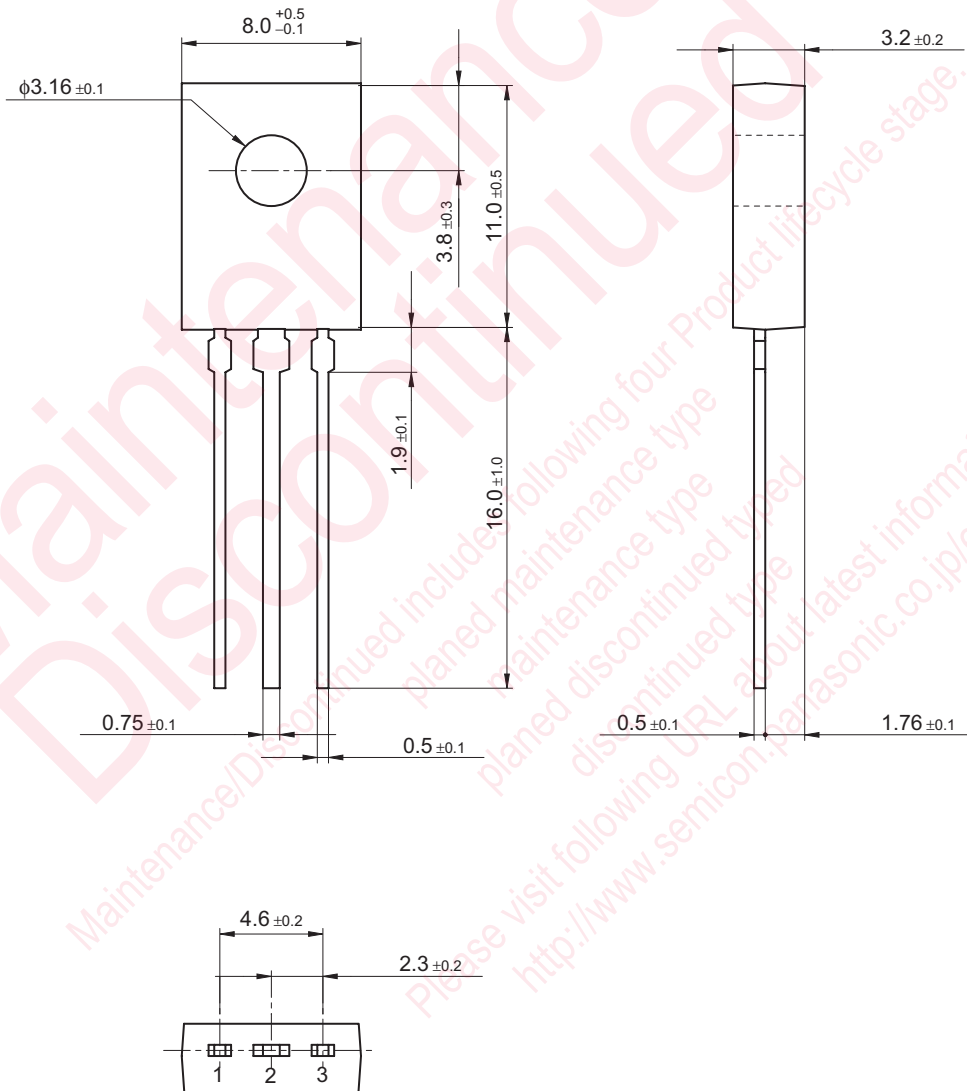

utions in using the technical information and scribed in this book

s book is to be exported or provided to non-residents, the laws and
rd to security export control, must be observed.

ly to show the main characteristics and application circuit examples
l property right or other right owned by our company or any other
any as to the infringement upon any such right owned by any other
rmation described in this book.

standard applications or general electronic equipment (such as office
and household appliances).

ng applications:

biles, traffic control equipment, combustion equipment, life support
reliability are required, or if the failure or malfunction of the prod-

ck are subject to change without notice for modification and/or im-
use of the products, therefore, ask for the most up-to-date Product
atisfy your requirements.

bsolute maximum rating and the guaranteed operating conditions
(.). Especially, please be careful not to exceed the range of absolute
er-off and mode-switching. Otherwise, we will not be liable for any

take into the consideration of incidence of break down and failure
n the systems such as redundant design, arresting the spread of fire
al injury, fire, social damages, for example, by using the products.

own and characteristics change due to external factors (ESD, EOS,
mounting or at customer's process. When using products for which
shelf life and the elapsed time since first opening the packages.

ly or partially, without the prior written permission of Matsushita

Looking for pricing, stock, or lifecycle information?

Click below to explore more details on WIN SOURCE:

 [View 2SD0946B on WIN SOURCE](#)

 [Panasonic Information](#)

Optimize Your Supply Chain with WIN SOURCE Solutions

-  Global Sourcing Solution
-  Obsolete Management
-  Cost Control Management
-  Shortage Management
-  Alternative Solution
-  Excess Inventory Management