

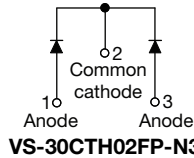

**THE DATASHEET OF
VS-30CTH02-N3**



Hyperfast Rectifier, 2 x 15 FRED Pt®

3L TO-220 FullPAK

FEATURES

- Hyperfast recovery time
- Low forward voltage drop
- 175 °C operating junction temperature
- Low leakage current
- Fully isolated package ($V_{INS} = 2500 V_{RMS}$)
- UL pending
- Designed and qualified according to JEDEC®-JESD 47
- Material categorization: for definitions of compliance please see www.vishay.com/doc?99912



RoHS
COMPLIANT
HALOGEN
FREE

DESCRIPTION / APPLICATIONS

200 V series are the state of the art hyperfast recovery rectifiers specifically designed with optimized performance of forward voltage drop and hyperfast recovery time.

The planar structure and the platinum doped life time control, guarantee the best overall performance, ruggedness and reliability characteristics.

These devices are intended for use in the output rectification stage of SMPS, UPS, DC/DC converters as well as freewheeling diode in low voltage inverters and chopper motor drives.

Their extremely optimized stored charge and low recovery current minimize the switching losses and reduce over dissipation in the switching element and snubbers.

PRIMARY CHARACTERISTICS	
$I_{F(AV)}$	2 x 15 A
V_R	200 V
V_F at I_F	0.78 V
t_{rr} typ.	See Recovery table
T_J max.	175 °C
Package	3L TO-220 FullPAK
Circuit configuration	Common cathode

ABSOLUTE MAXIMUM RATINGS				
PARAMETER	SYMBOL	TEST CONDITIONS	VALUES	UNITS
Peak repetitive reverse voltage	V_{RRM}		200	V
Average rectified forward current	$I_{F(AV)}$	$T_C = 125\text{ °C}$	15 30	A
			per diode per device	
Non-repetitive peak surge current	I_{FSM}	$T_J = 25\text{ °C}$	200	
Operating junction and storage temperatures	T_J, T_{Stg}		-65 to +175	°C

ELECTRICAL SPECIFICATIONS ($T_J = 25\text{ °C}$ unless otherwise specified)						
PARAMETER	SYMBOL	TEST CONDITIONS	MIN.	TYP.	MAX.	UNITS
Breakdown voltage, blocking voltage	V_{BR}, V_R	$I_R = 100\ \mu A$	200	-	-	V
Forward voltage	V_F	$I_F = 15\text{ A}$ $I_F = 15\text{ A}, T_J = 125\text{ °C}$	-	0.92 0.78	1.05 0.85	
Reverse leakage current	I_R	$V_R = V_R$ rated $T_J = 125\text{ °C}, V_R = V_R$ rated	-	-	10 300	μA
Junction capacitance	C_T	$V_R = 200\text{ V}$	-	57	-	pF
Series inductance	L_S	Measured lead to lead 5 mm from package body	-	8	-	nH



DYNAMIC RECOVERY CHARACTERISTICS ($T_C = 25\text{ }^\circ\text{C}$ unless otherwise specified)						
PARAMETER	SYMBOL	TEST CONDITIONS	MIN.	TYP.	MAX.	UNITS
Reverse recovery time	t_{rr}	$I_F = 1\text{ A}$, $di_F/dt = 50\text{ A}/\mu\text{s}$, $V_R = 30\text{ V}$	-	-	35	ns
		$I_F = 1\text{ A}$, $di_F/dt = 100\text{ A}/\mu\text{s}$, $V_R = 30\text{ V}$	-	-	30	
		$T_J = 25\text{ }^\circ\text{C}$	-	26	-	
		$T_J = 125\text{ }^\circ\text{C}$	-	40	-	
Peak recovery current	I_{RRM}	$I_F = 15\text{ A}$ $di_F/dt = 200\text{ A}/\mu\text{s}$ $V_R = 160\text{ V}$	$T_J = 25\text{ }^\circ\text{C}$	-	2.8	A
			$T_J = 125\text{ }^\circ\text{C}$	-	6.0	
Reverse recovery charge	Q_{rr}	$T_J = 25\text{ }^\circ\text{C}$	-	37	-	nC
		$T_J = 125\text{ }^\circ\text{C}$	-	120	-	

THERMAL - MECHANICAL SPECIFICATIONS						
PARAMETER	SYMBOL	TEST CONDITIONS	MIN.	TYP.	MAX.	UNITS
Maximum junction and storage temperature range	T_J , T_{Stg}		-65	-	175	$^\circ\text{C}$
Thermal resistance, junction-to-case per diode	R_{thJC}	Mounting surface, flat, smooth and greased	-	-	3.5	$^\circ\text{C}/\text{W}$
Marking device		Case style 3L TO-220 FullPAK	30CTH02FP			

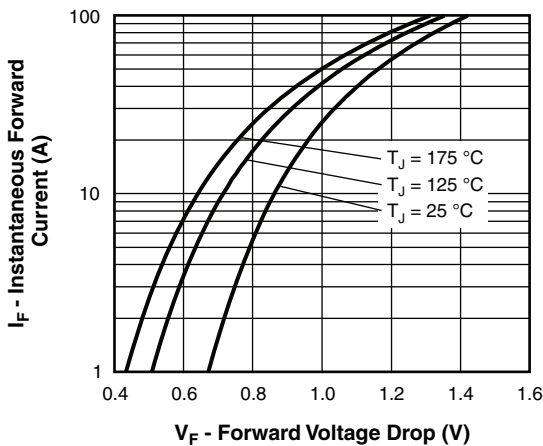

Fig. 1 - Typical Forward Voltage Drop Characteristics

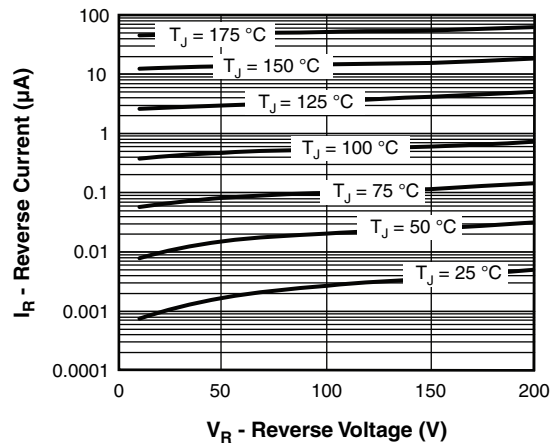

Fig. 2 - Typical Values of Reverse Current vs. Reverse Voltage

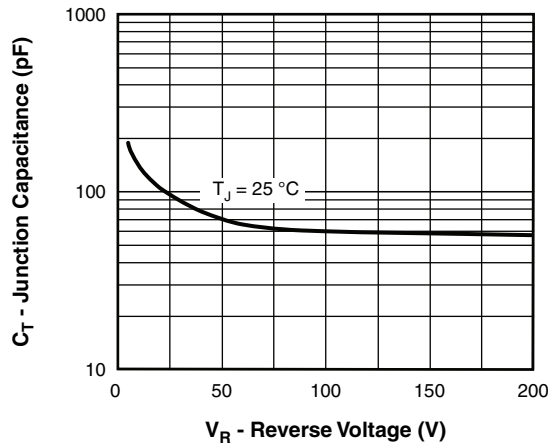

Fig. 3 - Typical Junction Capacitance vs. Reverse Voltage

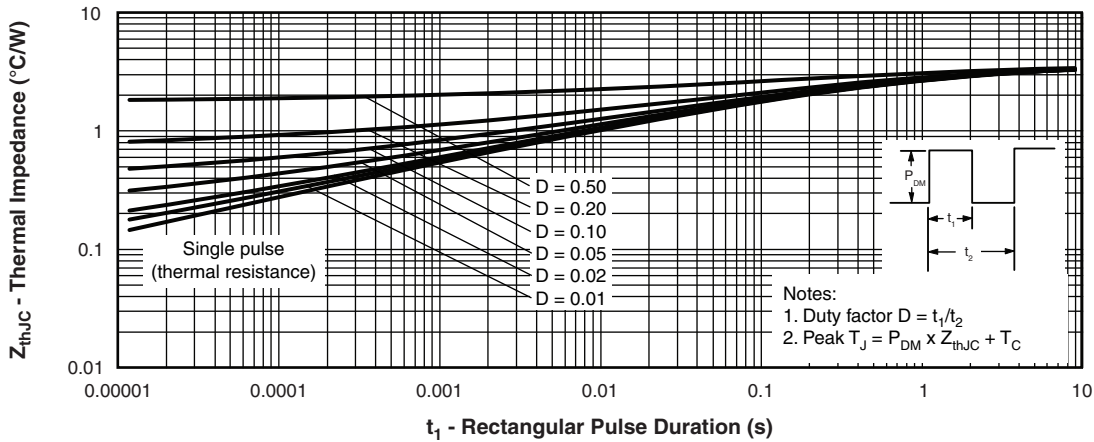

Fig. 4 - Maximum Thermal Impedance Z_{thJC} Characteristics

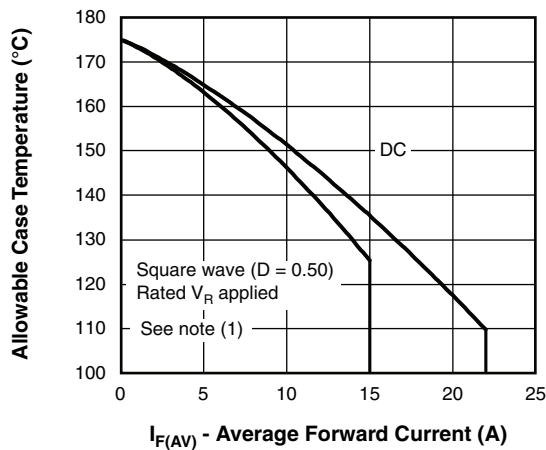

Fig. 5 - Maximum Allowable Case Temperature vs. Average Forward Current

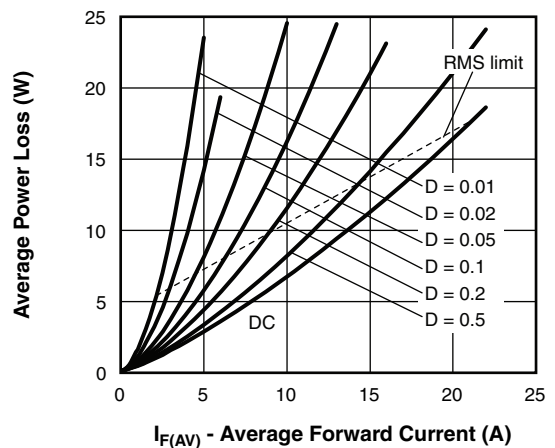

Fig. 6 - Forward Power Loss Characteristics

Note

- (1) Formula used: $T_C = T_J - (P_d + P_{dREV}) \times R_{thJC}$;
- P_d = forward power loss = $I_{F(AV)} \times V_{FM}$ at $(I_{F(AV)}/D)$ (see fig. 5);
- P_{dREV} = inverse power loss = $V_{R1} \times I_R (1 - D)$; I_R at V_{R1} = rated V_R

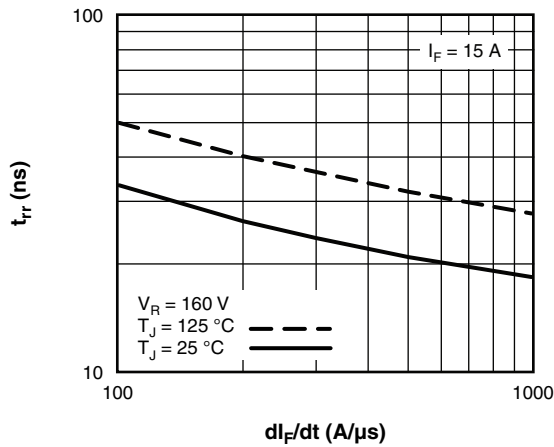

Fig. 7 - Typical Reverse Recovery Time vs. di_F/dt

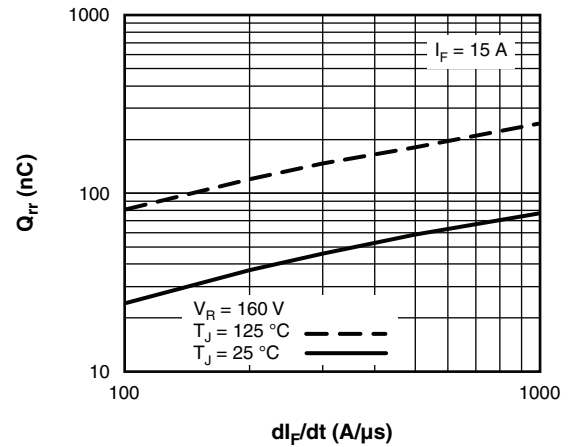
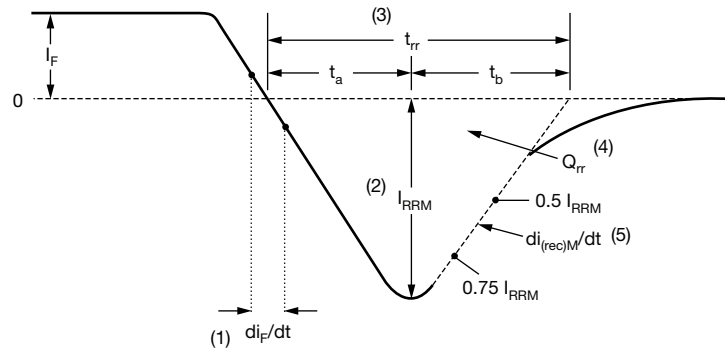

Fig. 8 - Typical Stored Charge vs. di_F/dt



- (1) di_F/dt - rate of change of current through zero crossing
- (2) I_{RRM} - peak reverse recovery current
- (3) t_{rr} - reverse recovery time measured from zero crossing point of negative going I_F to point where a line passing through $0.75 I_{RRM}$ and $0.50 I_{RRM}$ extrapolated to zero current.
- (4) Q_{rr} - area under curve defined by t_{rr} and I_{RRM}
- (5) $di_{(rec)M}/dt$ - peak rate of change of current during t_b portion of t_{rr}

$$Q_{rr} = \frac{t_{rr} \times I_{RRM}}{2}$$

Fig. 9 - Reverse Recovery Waveform and Definitions



ORDERING INFORMATION TABLE

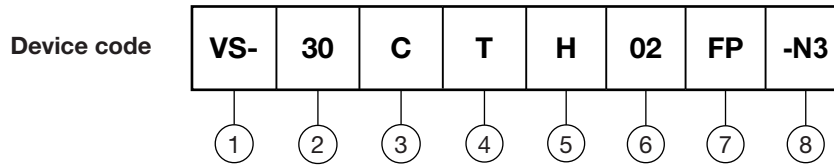

- 1** - Vishay Semiconductors product
- 2** - Current rating (30 = 30 A)
- 3** - C = common cathode
- 4** - T = TO-220
- 5** - H = hyperfast recovery
- 6** - Voltage rating (02 = 200 V)
- 7** - FP = 3L TO-220 FullPAK
- 8** - Environmental digit:
-N3 = halogen-free, RoHS-compliant, and totally lead (Pb)-free

ORDERING INFORMATION (Example)			
PREFERRED P/N	QUANTITY PER T/R	MINIMUM ORDER QUANTITY	PACKAGING DESCRIPTION
VS-20CTH03FP-N3	50	1000	Antistatic plastic tube

LINKS TO RELATED DOCUMENTS	
Dimensions	www.vishay.com/doc?96155
Part marking information	www.vishay.com/doc?95456



3L TO-220 FullPAK

DIMENSIONS in millimeters

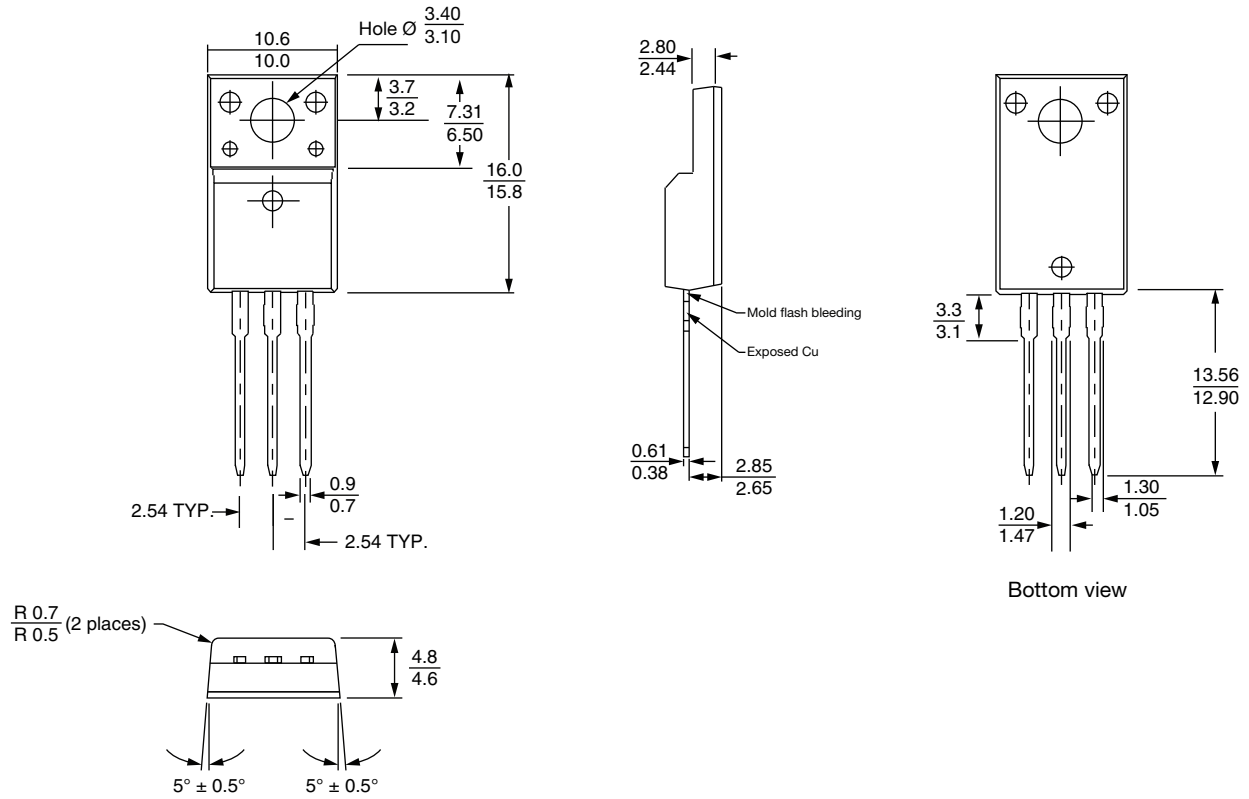

Notes

- (1) All dimensions are in mm
- (2) Package body size exclude mold flash and burrs. Moldflash should be less than 6 mils



Disclaimer

ALL PRODUCT, PRODUCT SPECIFICATIONS AND DATA ARE SUBJECT TO CHANGE WITHOUT NOTICE TO IMPROVE RELIABILITY, FUNCTION OR DESIGN OR OTHERWISE.

Vishay Intertechnology, Inc., its affiliates, agents, and employees, and all persons acting on its or their behalf (collectively, "Vishay"), disclaim any and all liability for any errors, inaccuracies or incompleteness contained in any datasheet or in any other disclosure relating to any product.

Vishay makes no warranty, representation or guarantee regarding the suitability of the products for any particular purpose or the continuing production of any product. To the maximum extent permitted by applicable law, Vishay disclaims (i) any and all liability arising out of the application or use of any product, (ii) any and all liability, including without limitation special, consequential or incidental damages, and (iii) any and all implied warranties, including warranties of fitness for particular purpose, non-infringement and merchantability.

Statements regarding the suitability of products for certain types of applications are based on Vishay's knowledge of typical requirements that are often placed on Vishay products in generic applications. Such statements are not binding statements about the suitability of products for a particular application. It is the customer's responsibility to validate that a particular product with the properties described in the product specification is suitable for use in a particular application. Parameters provided in datasheets and / or specifications may vary in different applications and performance may vary over time. All operating parameters, including typical parameters, must be validated for each customer application by the customer's technical experts. Product specifications do not expand or otherwise modify Vishay's terms and conditions of purchase, including but not limited to the warranty expressed therein.

Except as expressly indicated in writing, Vishay products are not designed for use in medical, life-saving, or life-sustaining applications or for any other application in which the failure of the Vishay product could result in personal injury or death. Customers using or selling Vishay products not expressly indicated for use in such applications do so at their own risk. Please contact authorized Vishay personnel to obtain written terms and conditions regarding products designed for such applications.

No license, express or implied, by estoppel or otherwise, to any intellectual property rights is granted by this document or by any conduct of Vishay. Product names and markings noted herein may be trademarks of their respective owners.

Looking for pricing, stock, or lifecycle information?

Click below to explore more details on WIN SOURCE:

 [View VS-30CTH02-N3 on WIN SOURCE](#)

 [Vishay Information](#)

Optimize Your Supply Chain with WIN SOURCE Solutions

-  Global Sourcing Solution
-  Obsolete Management
-  Cost Control Management
-  Shortage Management
-  Alternative Solution
-  Excess Inventory Management