



**THE DATASHEET OF
VS-40HF120**





Standard Recovery Diodes, (Stud Version), 40 A



DO-5 (DO-203AB)

FEATURES

- High surge current capability
- Stud cathode and stud anode version
- Leaded version available
- Types up to 1600 V V_{RRM}
- Designed and qualified for multiple level
- Material categorization: for definitions of compliance please see www.vishay.com/doc?99912



RoHS
COMPLIANT

TYPICAL APPLICATIONS

- Battery charges
- Converters
- Power supplies
- Machine tool controls
- Welding

PRIMARY CHARACTERISTICS	
$I_{F(AV)}$	40 A
Package	DO-5 (DO-203AB)
Circuit configuration	Single

MAJOR RATINGS AND CHARACTERISTICS				
PARAMETER	TEST CONDITIONS	40HF(R)		UNITS
		10 TO 120	140/160	
$I_{F(AV)}$		40	40	A
	T_C	140	110	°C
$I_{F(RMS)}$		62	62	A
I_{FSM}	50 Hz	570	570	A
	60 Hz	595	595	
I^2t	50 Hz	1600	1600	A ² s
	60 Hz	1450	1450	
V_{RRM}	Range	100 to 1200	1400 to 1600	V
T_J		-65 to 190	-65 to 160	°C

ELECTRICAL SPECIFICATIONS

VOLTAGE RATINGS				
TYPE NUMBER	VOLTAGE CODE	V_{RRM} , MAXIMUM REPETITIVE PEAK REVERSE VOLTAGE V	V_{RSM} , MAXIMUM NON-REPETITIVE PEAK REVERSE VOLTAGE V	I_{RRM} MAXIMUM AT $T_J = T_J$ MAXIMUM mA
VS-40HF(R)	10	100	200	9
	20	200	300	
	40	400	500	
	60	600	700	
	80	800	900	
	100	1000	1100	
	120	1200	1300	
	140	1400	1500	4.5
160	1600	1700		



FORWARD CONDUCTION						
PARAMETER	SYMBOL	TEST CONDITIONS		40HF(R)		UNITS
				10 TO 120	140/160	
Maximum average forward current at case temperature	$I_{F(AV)}$	180° conduction, half sine wave		40	40	A
Maximum RMS forward current	$I_{F(RMS)}$			140	110	°C
Maximum peak, one-cycle forward, non-repetitive surge current	I_{FSM}	t = 10 ms t = 8.3 ms	No voltage reappplied	62		A
		t = 10 ms t = 8.3 ms	100 % V_{RRM} reappplied	570		A
				595		
				480		
				500		
Maximum I^2t for fusing	I^2t	t = 10 ms t = 8.3 ms	No voltage reappplied	1600		A ² s
		t = 10 ms t = 8.3 ms	100 % V_{RRM} reappplied	1450		
				1150		
				1050		
Maximum $I^2\sqrt{t}$ for fusing	$I^2\sqrt{t}$	t = 0.1 ms to 10 ms, no voltage reappplied		16 000		A ² √s
Value of threshold voltage (up to 1200 V)	$V_{F(TO)}$	$T_J = T_J$ maximum		0.65		V
Value of threshold voltage (for 1400 V/1600 V)	$V_{F(TO)}$			0.76		
Value of forward slope resistance (up to 1200 V)	r_f	$T_J = T_J$ maximum		4.29		mΩ
Value of forward slope resistance (for 1400 V/1600 V)	r_f			3.8		
Maximum forward voltage drop	V_{FM}	$I_{pk} = 125$ A, $T_J = 25$ °C, $t_p = 400$ μs rectangular wave		1.30	1.50	V

THERMAL AND MECHANICAL SPECIFICATIONS						
PARAMETER	SYMBOL	TEST CONDITIONS		40HF(R)		UNITS
				10 to 120	140 to 160	
Maximum junction operating and storage temperature range	T_J, T_{Stg}			-65 to 190	-65 to 160	°C
Maximum thermal resistance, junction to case	R_{thJC}	DC operation		0.95		K/W
Maximum thermal resistance, case to heatsink	R_{thCS}	Mounting surface, smooth, flat and greased		0.25		
Maximum allowable mounting torque (+0 %, -10 %)		Not lubricated thread, tightening on nut ⁽¹⁾		3.4 (30)		N · m (lbf · in)
		Lubricated thread, tightening on nut ⁽¹⁾		2.3 (20)		
		Not lubricated thread, tightening on hexagon ⁽²⁾		4.2 (37)		
		Lubricated thread, tightening on hexagon ⁽²⁾		3.2 (28)		
Approximate weight				17		g
				0.6		oz.
Case style		See dimensions - link at the end of datasheet		DO-5 (DO-203AB)		

Notes

- (1) Recommended for pass-through holes
- (2) Recommended for holed threaded heatsinks

ΔR_{thJC} CONDUCTION				
CONDUCTION ANGLE	SINUSOIDAL CONDUCTION	RECTANGULAR CONDUCTION	TEST CONDITIONS	UNITS
180°	0.14	0.10	$T_J = T_J$ maximum	K/W
120°	0.16	0.17		
90°	0.21	0.22		
60°	0.30	0.31		
30°	0.50	0.50		

Note

- The table above shows the increment of thermal resistance R_{thJC} when devices operate at different conduction angles than DC

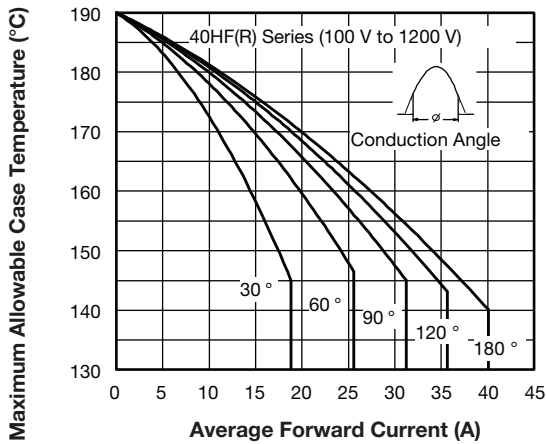

Fig. 1 - Current Ratings Characteristics

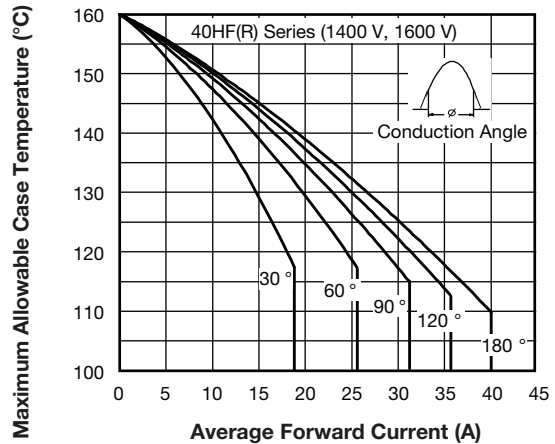

Fig. 3 - Current Ratings Characteristics

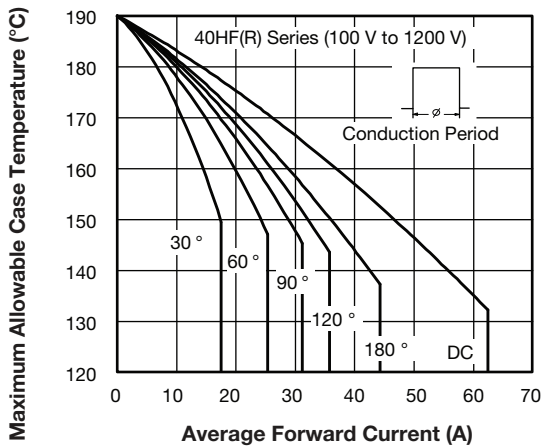

Fig. 2 - Current Ratings Characteristics

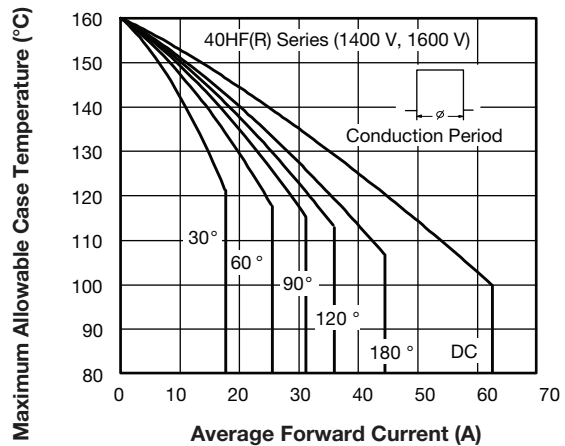

Fig. 4 - Current Ratings Characteristics

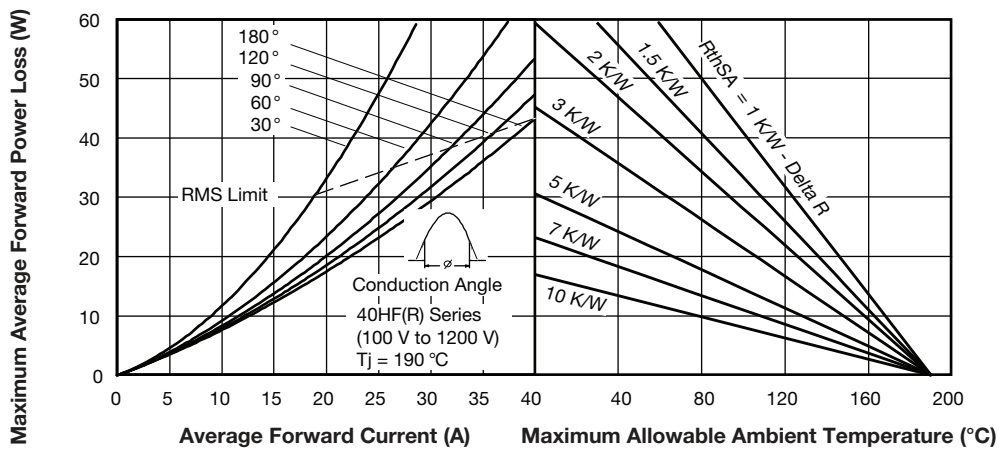

Fig. 5 - Forward Power Loss Characteristics

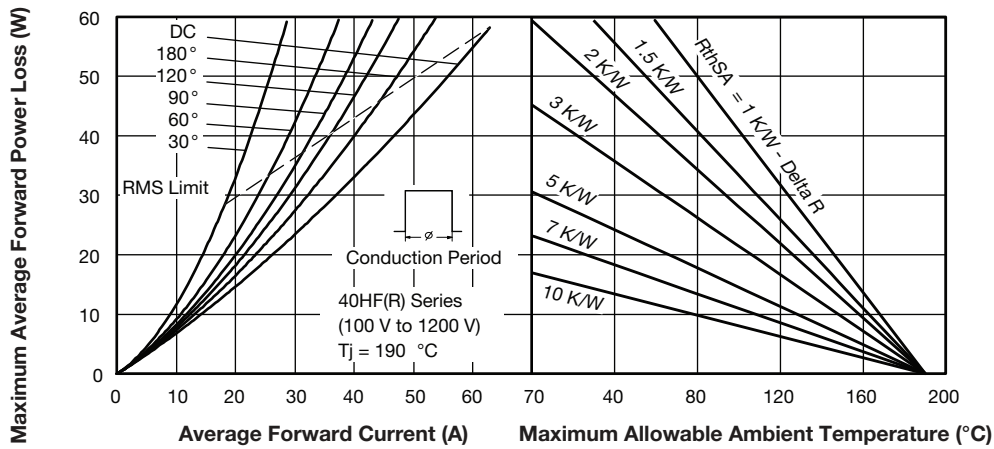

Fig. 6 - Forward Power Loss Characteristics

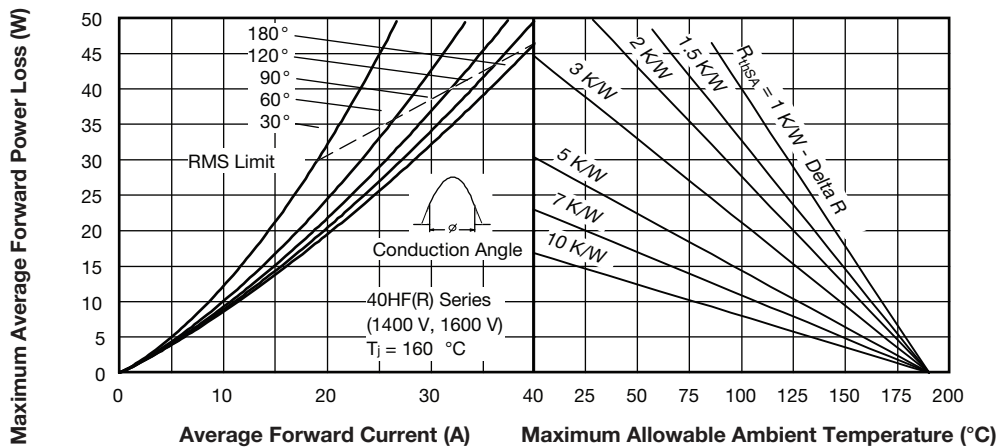

Fig. 7 - Forward Power Loss Characteristics

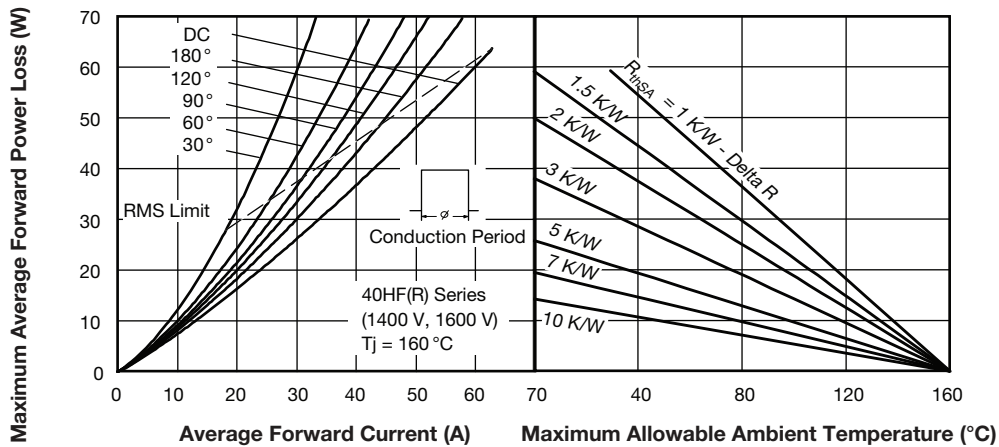

Fig. 8 - Forward Power Loss Characteristics

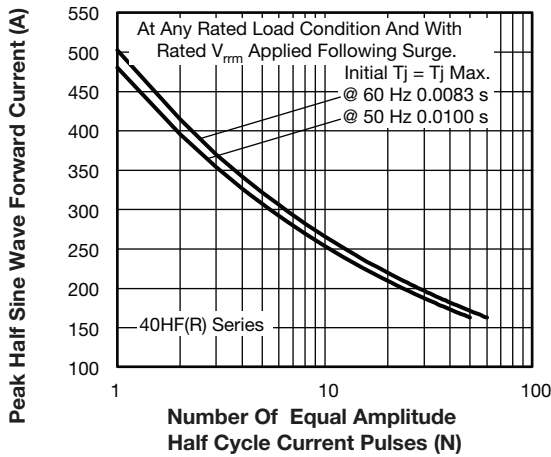

Fig. 9 - Maximum Non-Repetitive Surge Current

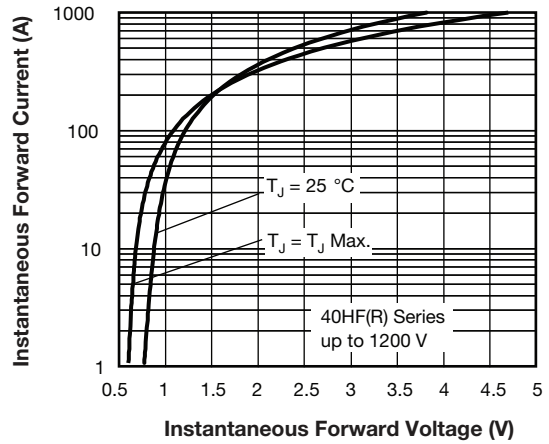

Fig. 11 - Forward Voltage Drop Characteristics (Up To 1200 V)

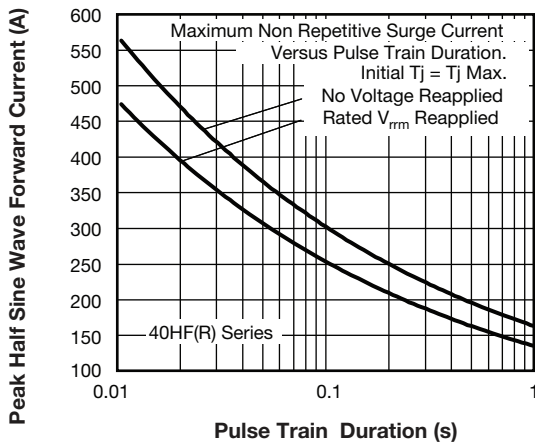

Fig. 10 - Maximum Non-Repetitive Surge Current

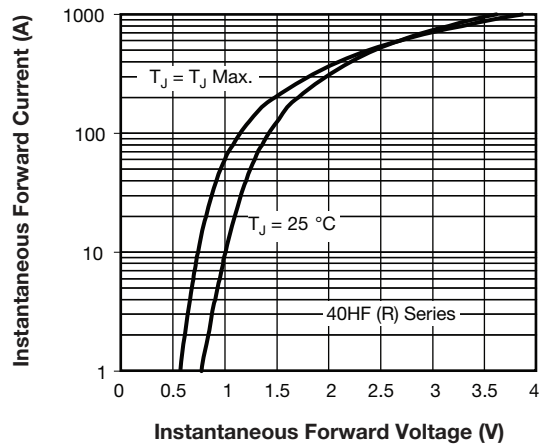

Fig. 12 - Forward Voltage Drop Characteristics (For 1400 V/1600 V)

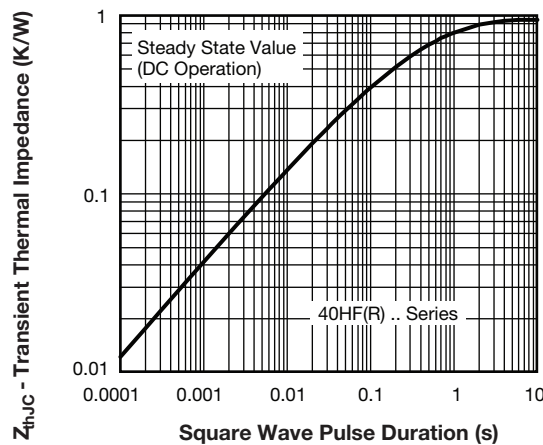
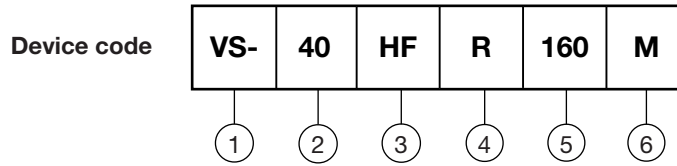

Fig. 13 - Thermal Impedance Z_{thJC} Characteristics



ORDERING INFORMATION TABLE



- 1** - Vishay Semiconductors product
- 2** -
 - 40 = standard device
 - 41 = not isolated lead
 - 42 = isolated lead with silicone sleeve
(red = reverse polarity)
(blue = normal polarity)
- 3** - HF = standard diode
- 4** -
 - None = stud normal polarity (cathode to stud)
 - R = stud reverse polarity (anode to stud)
- 5** - Voltage code x 10 = V_{RRM} (see Voltage Ratings table)
- 6** -
 - None = stud base DO-5 (DO-203AB) 1/4" 28UNF-2A
 - M = stud base DO-5 (DO-203AB) M6 x 1

LINKS TO RELATED DOCUMENTS	
Dimensions	www.vishay.com/doc?95344

DO-203AB (DO-5) for 40HF(R) and 41HF(R) Series

DIMENSIONS FOR 40HF(R) SERIES in millimeters (inches)

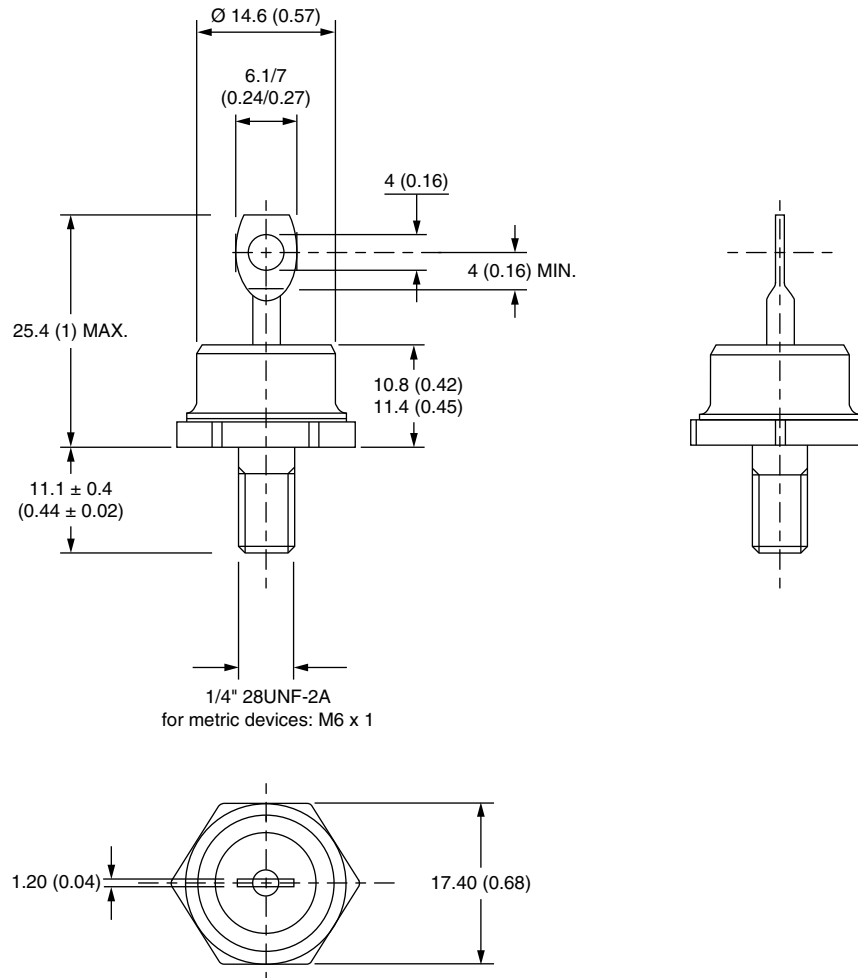

Outline Dimensions

Vishay Semiconductors

DO-203AB (DO-5) for 40HF(R)
and 41HF(R) Series



DIMENSIONS FOR 41HF(R) SERIES in millimeters (inches)

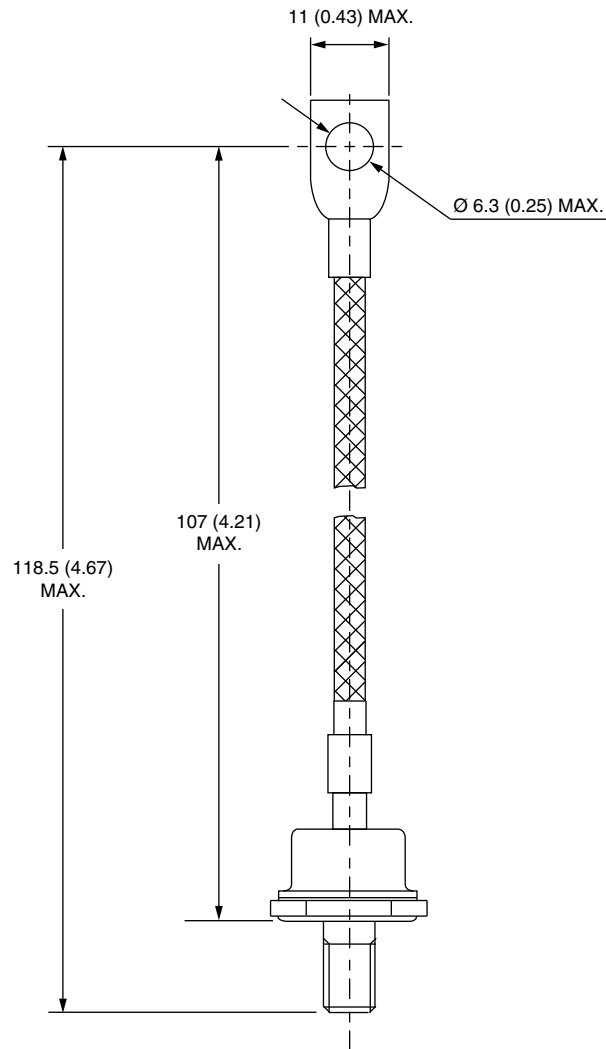



Disclaimer

ALL PRODUCT, PRODUCT SPECIFICATIONS AND DATA ARE SUBJECT TO CHANGE WITHOUT NOTICE TO IMPROVE RELIABILITY, FUNCTION OR DESIGN OR OTHERWISE.

Vishay Intertechnology, Inc., its affiliates, agents, and employees, and all persons acting on its or their behalf (collectively, "Vishay"), disclaim any and all liability for any errors, inaccuracies or incompleteness contained in any datasheet or in any other disclosure relating to any product.

Vishay makes no warranty, representation or guarantee regarding the suitability of the products for any particular purpose or the continuing production of any product. To the maximum extent permitted by applicable law, Vishay disclaims (i) any and all liability arising out of the application or use of any product, (ii) any and all liability, including without limitation special, consequential or incidental damages, and (iii) any and all implied warranties, including warranties of fitness for particular purpose, non-infringement and merchantability.

Statements regarding the suitability of products for certain types of applications are based on Vishay's knowledge of typical requirements that are often placed on Vishay products in generic applications. Such statements are not binding statements about the suitability of products for a particular application. It is the customer's responsibility to validate that a particular product with the properties described in the product specification is suitable for use in a particular application. Parameters provided in datasheets and / or specifications may vary in different applications and performance may vary over time. All operating parameters, including typical parameters, must be validated for each customer application by the customer's technical experts. Product specifications do not expand or otherwise modify Vishay's terms and conditions of purchase, including but not limited to the warranty expressed therein.

Except as expressly indicated in writing, Vishay products are not designed for use in medical, life-saving, or life-sustaining applications or for any other application in which the failure of the Vishay product could result in personal injury or death. Customers using or selling Vishay products not expressly indicated for use in such applications do so at their own risk. Please contact authorized Vishay personnel to obtain written terms and conditions regarding products designed for such applications.

No license, express or implied, by estoppel or otherwise, to any intellectual property rights is granted by this document or by any conduct of Vishay. Product names and markings noted herein may be trademarks of their respective owners.

Looking for pricing, stock, or lifecycle information?

Click below to explore more details on WIN SOURCE:

 [View VS-40HF120 on WIN SOURCE](#)

 [Vishay Information](#)

Optimize Your Supply Chain with WIN SOURCE Solutions

-  Global Sourcing Solution
-  Obsolete Management
-  Cost Control Management
-  Shortage Management
-  Alternative Solution
-  Excess Inventory Management