



Is Now Part of



ON Semiconductor®

To learn more about ON Semiconductor, please visit our website at
www.onsemi.com

Please note: As part of the Fairchild Semiconductor integration, some of the Fairchild orderable part numbers will need to change in order to meet ON Semiconductor's system requirements. Since the ON Semiconductor product management systems do not have the ability to manage part nomenclature that utilizes an underscore (_), the underscore (_) in the Fairchild part numbers will be changed to a dash (-). This document may contain device numbers with an underscore (_). Please check the ON Semiconductor website to verify the updated device numbers. The most current and up-to-date ordering information can be found at www.onsemi.com. Please email any questions regarding the system integration to Fairchild_questions@onsemi.com.

ON Semiconductor and the ON Semiconductor logo are trademarks of Semiconductor Components Industries, LLC dba ON Semiconductor or its subsidiaries in the United States and/or other countries. ON Semiconductor owns the rights to a number of patents, trademarks, copyrights, trade secrets, and other intellectual property. A listing of ON Semiconductor's product/patent coverage may be accessed at www.onsemi.com/site/pdf/Patent-Marking.pdf. ON Semiconductor reserves the right to make changes without further notice to any products herein. ON Semiconductor makes no warranty, representation or guarantee regarding the suitability of its products for any particular purpose, nor does ON Semiconductor assume any liability arising out of the application or use of any product or circuit, and specifically disclaims any and all liability, including without limitation special, consequential or incidental damages. Buyer is responsible for its products and applications using ON Semiconductor products, including compliance with all laws, regulations and safety requirements or standards, regardless of any support or applications information provided by ON Semiconductor. "Typical" parameters which may be provided in ON Semiconductor data sheets and/or specifications can and do vary in different applications and actual performance may vary over time. All operating parameters, including "Typicals" must be validated for each customer application by customer's technical experts. ON Semiconductor does not convey any license under its patent rights nor the rights of others. ON Semiconductor products are not designed, intended, or authorized for use as a critical component in life support systems or any FDA Class 3 medical devices or medical devices with a same or similar classification in a foreign jurisdiction or any devices intended for implantation in the human body. Should Buyer purchase or use ON Semiconductor products for any such unintended or unauthorized application, Buyer shall indemnify and hold ON Semiconductor and its officers, employees, subsidiaries, affiliates, and distributors harmless against all claims, costs, damages, and expenses, and reasonable attorney fees arising out of, directly or indirectly, any claim of personal injury or death associated with such unintended or unauthorized use, even if such claim alleges that ON Semiconductor was negligent regarding the design or manufacture of the part. ON Semiconductor is an Equal Opportunity/Affirmative Action Employer. This literature is subject to all applicable copyright laws and is not for resale in any manner.



December 2014

4N29M, 4N30M, 4N32M, 4N33M, H11B1M, TIL113M 6-Pin DIP General Purpose Photodarlington Optocoupler

Features

- High Sensitivity to Low Input Drive Current
- Meets or Exceeds All JEDEC Registered Specifications
- Safety and Regulatory Approvals:
 - UL1577, 4,170 VAC_{RMS} for 1 Minute
- DIN-EN/IEC60747-5-5, 850 V Peak Working Insulation Voltage

Applications

- Low Power Logic Circuits
- Telecommunications Equipment
- Portable Electronics
- Solid State Relays
- Interfacing Coupling Systems of Different Potentials and Impedances

Description

The 4N29M, 4N30M, 4N32M, 4N33M, H11B1M, and TIL113M have a gallium arsenide infrared emitter optically coupled to a silicon planar photodarlington.

Schematic

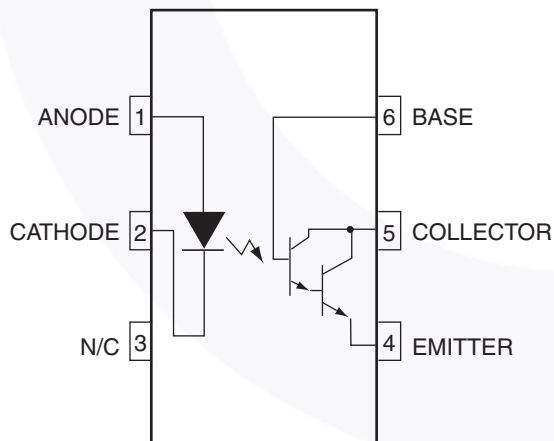

Figure 1. Schematic

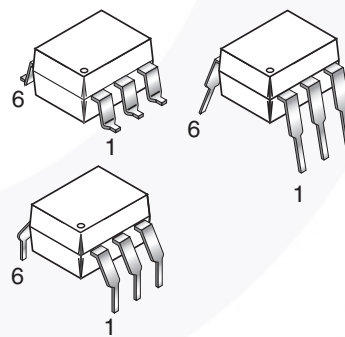

Figure 2. Package Outlines

Safety and Insulation Ratings

As per DIN EN/IEC 60747-5-5, this optocoupler is suitable for “safe electrical insulation” only within the safety limit data. Compliance with the safety ratings shall be ensured by means of protective circuits.

Parameter		Characteristics
Installation Classifications per DIN VDE 0110/1.89 Table 1, For Rated Mains Voltage	< 150 V _{RMS}	I–IV
	< 300 V _{RMS}	I–IV
Climatic Classification		55/100/21
Pollution Degree (DIN VDE 0110/1.89)		2
Comparative Tracking Index		175

Symbol	Parameter	Value	Unit
V _{PR}	Input-to-Output Test Voltage, Method A, V _{IORM} × 1.6 = V _{PR} , Type and Sample Test with t _m = 10 s, Partial Discharge < 5 pC	1360	V _{peak}
	Input-to-Output Test Voltage, Method B, V _{IORM} × 1.875 = V _{PR} , 100% Production Test with t _m = 1 s, Partial Discharge < 5 pC	1594	V _{peak}
V _{IORM}	Maximum Working Insulation Voltage	850	V _{peak}
V _{IOTM}	Highest Allowable Over-Voltage	6000	V _{peak}
	External Creepage	≥ 7	mm
	External Clearance	≥ 7	mm
	External Clearance (for Option TV, 0.4" Lead Spacing)	≥ 10	mm
DTI	Distance Through Insulation (Insulation Thickness)	≥ 0.5	mm
T _S	Case Temperature ⁽¹⁾	175	°C
I _{S,INPUT}	Input Current ⁽¹⁾	350	mA
P _{S,OUTPUT}	Output Power ⁽¹⁾	800	mW
R _{IO}	Insulation Resistance at T _S , V _{IO} = 500 V ⁽¹⁾	> 10 ⁹	Ω

Note:

1. Safety limit values – maximum values allowed in the event of a failure.

Absolute Maximum Ratings

Stresses exceeding the absolute maximum ratings may damage the device. The device may not function or be operable above the recommended operating conditions and stressing the parts to these levels is not recommended. In addition, extended exposure to stresses above the recommended operating conditions may affect device reliability. The absolute maximum ratings are stress ratings only.

Symbol	Parameter	Value	Unit
TOTAL DEVICE			
T_{STG}	Storage Temperature	-40 to +125	°C
T_{OPR}	Operating Temperature	-40 to +100	°C
T_J	Junction Temperature	-40 to +125	°C
T_{SOL}	Lead Solder Temperature	260 for 10 seconds	°C
P_D	Total Device Power Dissipation @ $T_A = 25^\circ\text{C}$	270	mW
	Derate Above 25°C	3.3	mW/°C
EMITTER			
I_F	Continuous Forward Current	80	mA
V_R	Reverse Voltage	3	V
$I_F(pk)$	Forward Current – Peak (300 μs , 2% Duty Cycle)	3.0	A
P_D	LED Power Dissipation @ $T_A = 25^\circ\text{C}$	120	mW
	Derate above 25°C	2.0	mW/°C
DETECTOR			
BV_{CEO}	Collector-Emitter Breakdown Voltage	30	V
BV_{CBO}	Collector-Base Breakdown Voltage	30	V
BV_{ECO}	Emitter-Collector Breakdown Voltage	5	V
P_D	Detector Power Dissipation @ $T_A = 25^\circ\text{C}$	150	mW
	Derate Above 25°C	2.0	mW/°C
I_C	Continuous Collector Current	150	mA

Electrical Characteristics

$T_A = 25^\circ\text{C}$ Unless otherwise specified.

Individual Component Characteristics

Symbol	Parameter	Test Conditions	Device	Min.	Typ.	Max.	Unit
EMITTER							
V_F	Input Forward Voltage ⁽²⁾	$I_F = 10\text{ mA}$	4NXXM		1.2	1.5	V
			H11B1M, TIL113M	0.8	1.2	1.5	V
I_R	Reverse Leakage Current ⁽²⁾	$V_R = 3.0\text{ V}$	4NXXM		0.001	100	μA
		$V_R = 6.0\text{ V}$	H11B1M, TIL113M		0.001	10	μA
C	Capacitance ⁽²⁾	$V_F = 0\text{ V}, f = 1.0\text{ MHz}$	All		150		pF
DETECTOR							
BV_{CEO}	Collector-Emitter Breakdown Voltage ⁽²⁾	$I_C = 1.0\text{ mA}, I_B = 0$	4NXXM, TIL113M	30	60		V
			H11B1M	25	60		V
BV_{CBO}	Collector-Base Breakdown Voltage ⁽²⁾	$I_C = 100\ \mu\text{A}, I_E = 0$	All	30	100		V
BV_{ECO}	Emitter-Collector Breakdown Voltage ⁽²⁾	$I_E = 100\ \mu\text{A}, I_B = 0$	4NXXM	5.0	10		V
			H11B1M, TIL113M	7	10		V
I_{CEO}	Collector-Emitter Dark Current ⁽²⁾	$V_{CE} = 10\text{ V}, \text{Base Open}$	All		1	100	nA

Notes:

2. Indicates JEDEC registered data.

Electrical Characteristics (Continued) $T_A = 25^\circ\text{C}$ Unless otherwise specified.**Transfer Characteristics**

Symbol	Parameter	Test Conditions	Device	Min.	Typ.	Max.	Unit
DC CHARACTERISTICS							
$I_{C(CTR)}$	Collector Output Current ⁽³⁾⁽⁴⁾⁽⁵⁾	$I_F = 10\text{ mA}, V_{CE} = 10\text{ V}, I_B = 0$	4N32M, 4N33M	50 (500)			mA (%)
			4N29M, 4N30M	10 (100)			mA (%)
		$I_F = 1\text{ mA}, V_{CE} = 5\text{ V}$	H11B1M	5 (500)			mA (%)
		$I_F = 10\text{ mA}, V_{CE} = 1\text{ V}$	TIL113M	30 (300)			mA (%)
$V_{CE(SAT)}$	Saturation Voltage ⁽³⁾⁽⁵⁾	$I_F = 8\text{ mA}, I_C = 2.0\text{ mA}$	4NXXM			1.0	V
			TIL113M			1.25	V
		$I_F = 1\text{ mA}, I_C = 1\text{ mA}$	H11B1M			1.0	V
AC CHARACTERISTICS							
t_{on}	Turn-on Time	$I_F = 200\text{ mA}, I_C = 50\text{ mA}, V_{CC} = 10\text{ V}, R_L = 100\ \Omega$	4NXXM, TIL113M			5.0	μs
		$I_F = 10\text{ mA}, V_{CE} = 10\text{ V}, R_L = 100\ \Omega$	H11B1M		25		μs
t_{off}	Turn-off Time	$I_F = 200\text{ mA}, I_C = 50\text{ mA}, V_{CC} = 10\text{ V}, R_L = 100\ \Omega$	4N32M, 4N33M, TIL113M			100	μs
			4N29M, 4N30M			40	μs
		$I_F = 10\text{ mA}, V_{CE} = 10\text{ V}, R_L = 100\ \Omega$	H11B1M		18		μs
BW	Bandwidth ⁽⁶⁾⁽⁷⁾				30		kHz

Notes:

- Indicates JEDEC registered data.
- The current transfer ratio(I_C / I_F) is the ratio of the detector collector current to the LED input current.
- Pulse test: pulse width = 300 μs , duty cycle $\leq 2.0\%$.
- I_F adjusted to $I_C = 2.0\text{ mA}$ and $I_C = 0.7\text{ mA rms}$.
- The frequency at which I_C is 3 dB down from the 1 kHz value.

Isolation Characteristics

Symbol	Characteristic	Test Conditions	Min.	Typ.	Max.	Unit
V_{ISO}	Input-Output Isolation Voltage	$t = 1\text{ Minute}$	4170			$V_{AC(RMS)}$
C_{ISO}	Isolation Capacitance	$V_{I-O} = 0\text{ V}, f = 1\text{ MHz}$		0.2		pF
R_{ISO}	Isolation Resistance	$V_{I-O} = \pm 500\text{ VDC}, T_A = 25^\circ\text{C}$	10^{11}			Ω

Typical Performance Curves

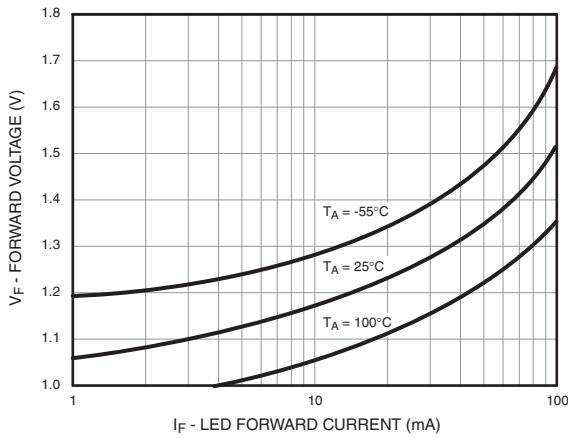

Figure 3. LED Forward Voltage vs. Forward Current

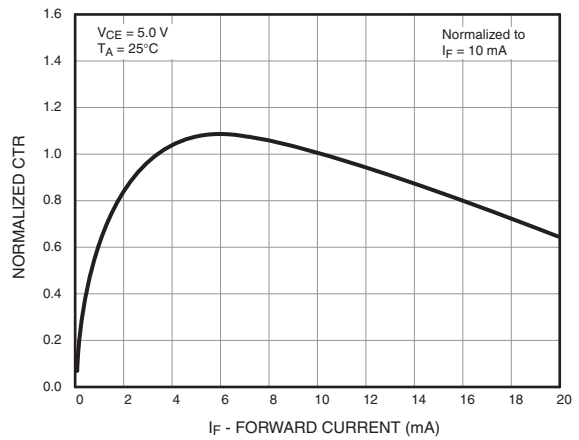

Figure 4. Normalized CTR vs. Forward Current

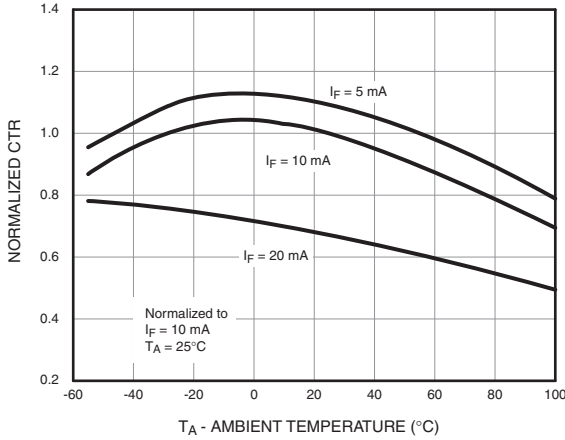

Figure 5. Normalized CTR vs. Ambient Temperature

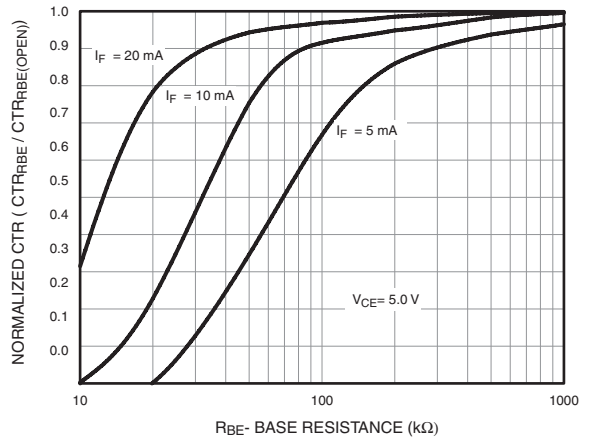

Figure 6. CTR vs. R_{BE} (Unsaturated)

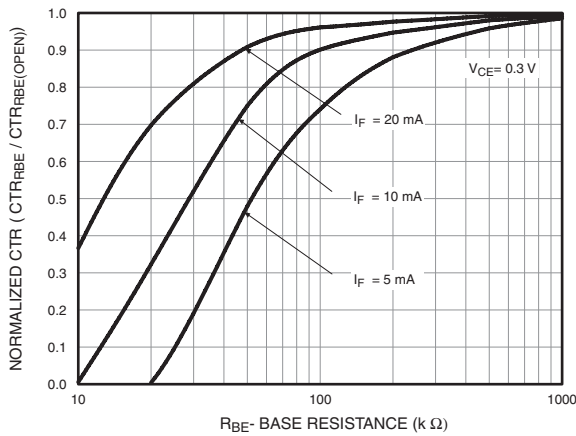

Figure 7. CTR vs. R_{BE} (Saturated)

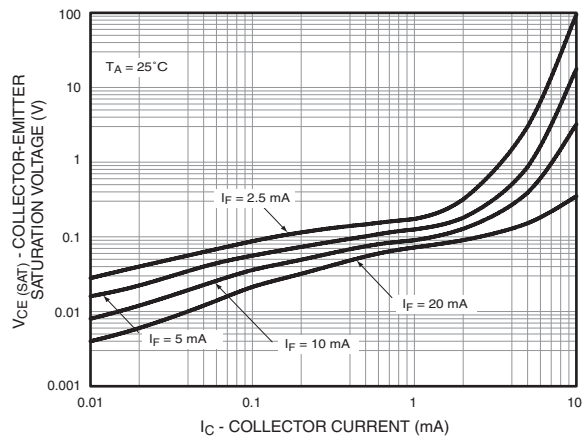

Figure 8. Collector-Emitter Saturation Voltage vs. Collector Current

Typical Performance Curves (Continued)

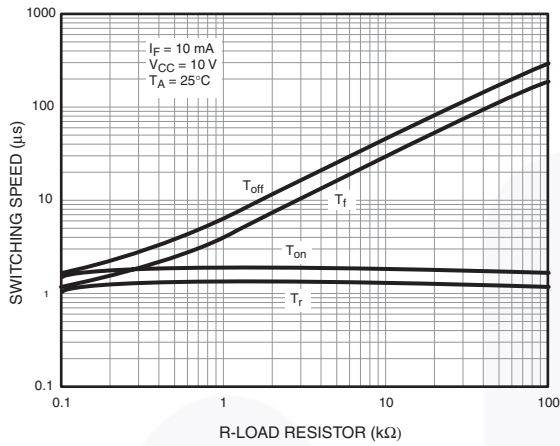

Figure 9. Switching Speed vs. Load Resistor

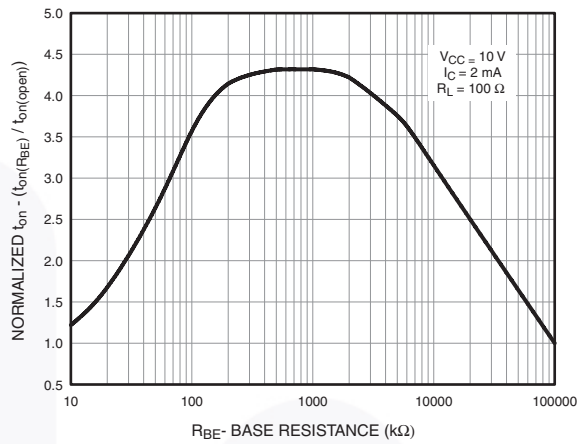

Figure 10. Normalized t_{on} vs. R_{BE}

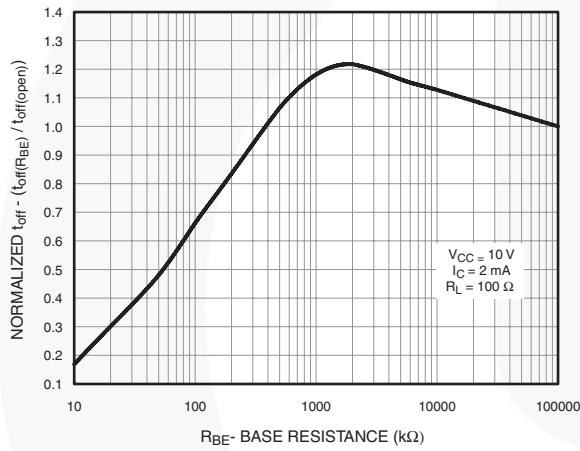

Figure 11. Normalized t_{off} vs. R_{BE}

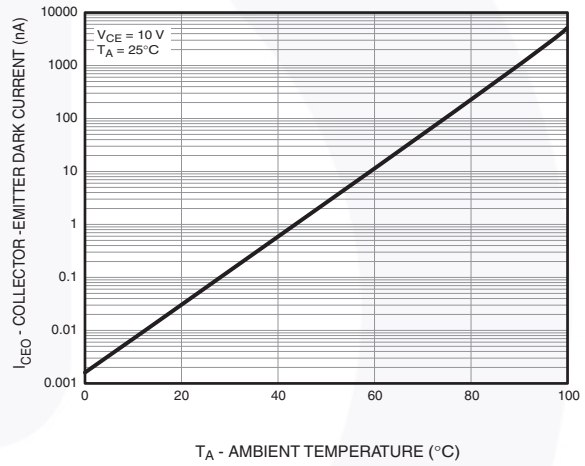

Figure 12. Dark Current vs. Ambient Temperature

Switching Time Test Circuit and Waveform

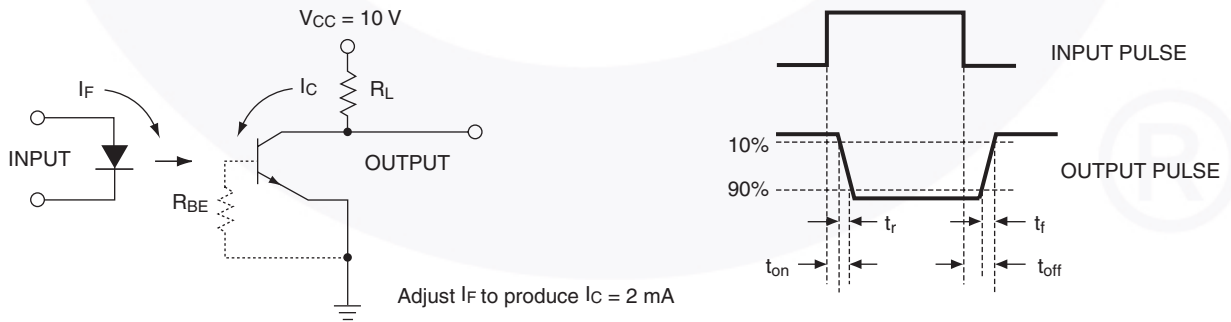

Figure 13. Switching Time Test Circuit and Waveform

Reflow Profile

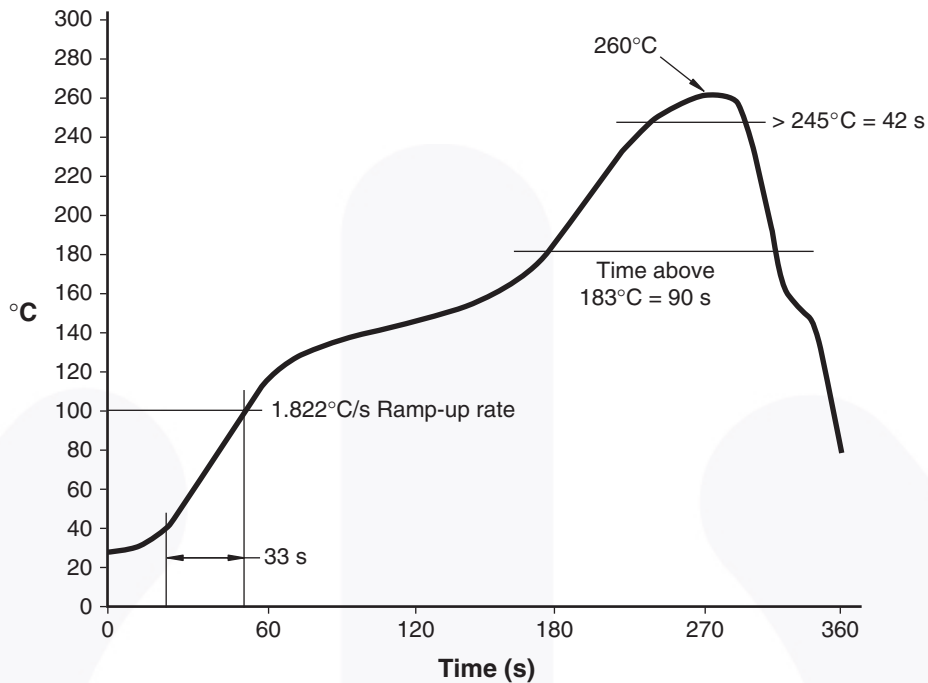

Figure 14. Reflow Profile

Ordering Information

Part Number	Package	Packing Method
4N29M	DIP 6-Pin	Tube (50 Units)
4N29SM	SMT 6-Pin (Lead Bend)	Tube (50 Units)
4N29SR2M	SMT 6-Pin (Lead Bend)	Tape and Reel (1000 Units)
4N29VM	DIP 6-Pin, DIN EN/IEC60747-5-5 Option	Tube (50 Units)
4N29SVM	SMT 6-Pin (Lead Bend), DIN EN/IEC60747-5-5 Option	Tube (50 Units)
4N29SR2VM	SMT 6-Pin (Lead Bend), DIN EN/IEC60747-5-5 Option	Tape and Reel (1000 Units)
4N29TVM	DIP 6-Pin, 0.4" Lead Spacing, DIN EN/IEC60747-5-5 Option	Tube (50 Units)

Note:

8. The product orderable part number system listed in this table also applies to the 4N30M, 4N32M, 4N33M, H11B1M, and TIL113M devices.

Marking Information

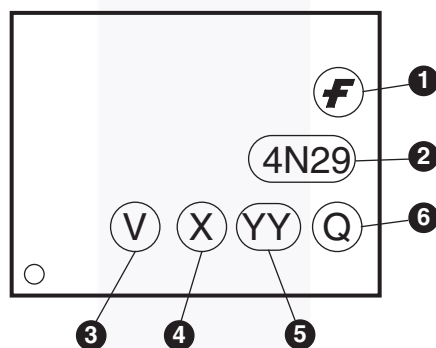

Figure 15. Top Mark

Table 1. Top Mark Definitions

1	Fairchild Logo
2	Device Number
3	DIN EN/IEC60747-5-5 Option (only appears on component ordered with this option)
4	One-Digit Year Code, e.g., "4"
5	Digit Work Week, Ranging from "01" to "53"
6	Assembly Package Code



NOTES:

- A) NO STANDARD APPLIES TO THIS PACKAGE.
- B) ALL DIMENSIONS ARE IN MILLIMETERS.
- C) DIMENSIONS ARE EXCLUSIVE OF BURRS, MOLD FLASH, AND TIE BAR EXTRUSION
- D) DRAWING FILENAME AND REVISION: MKT-N06BREV4.





LAND PATTERN RECOMMENDATION



NOTES:

- A) NO STANDARD APPLIES TO THIS PACKAGE.
- B) ALL DIMENSIONS ARE IN MILLIMETERS.
- C) DIMENSIONS ARE EXCLUSIVE OF BURRS, MOLD FLASH, AND TIE BAR EXTRUSION
- D) DRAWING FILENAME AND REVISION : MKT-N06CREV4.





NOTES:

- A) NO STANDARD APPLIES TO THIS PACKAGE.
- B) ALL DIMENSIONS ARE IN MILLIMETERS.
- C) DIMENSIONS ARE EXCLUSIVE OF BURRS, MOLD FLASH, AND TIE BAR EXTRUSION
- D) DRAWING FILENAME AND REVISION: MKT-N06Drev4



ON Semiconductor and  are trademarks of Semiconductor Components Industries, LLC dba ON Semiconductor or its subsidiaries in the United States and/or other countries. ON Semiconductor owns the rights to a number of patents, trademarks, copyrights, trade secrets, and other intellectual property. A listing of ON Semiconductor's product/patent coverage may be accessed at www.onsemi.com/site/pdf/Patent-Marking.pdf. ON Semiconductor reserves the right to make changes without further notice to any products herein. ON Semiconductor makes no warranty, representation or guarantee regarding the suitability of its products for any particular purpose, nor does ON Semiconductor assume any liability arising out of the application or use of any product or circuit, and specifically disclaims any and all liability, including without limitation special, consequential or incidental damages. Buyer is responsible for its products and applications using ON Semiconductor products, including compliance with all laws, regulations and safety requirements or standards, regardless of any support or applications information provided by ON Semiconductor. "Typical" parameters which may be provided in ON Semiconductor data sheets and/or specifications can and do vary in different applications and actual performance may vary over time. All operating parameters, including "Typicals" must be validated for each customer application by customer's technical experts. ON Semiconductor does not convey any license under its patent rights nor the rights of others. ON Semiconductor products are not designed, intended, or authorized for use as a critical component in life support systems or any FDA Class 3 medical devices or medical devices with a same or similar classification in a foreign jurisdiction or any devices intended for implantation in the human body. Should Buyer purchase or use ON Semiconductor products for any such unintended or unauthorized application, Buyer shall indemnify and hold ON Semiconductor and its officers, employees, subsidiaries, affiliates, and distributors harmless against all claims, costs, damages, and expenses, and reasonable attorney fees arising out of, directly or indirectly, any claim of personal injury or death associated with such unintended or unauthorized use, even if such claim alleges that ON Semiconductor was negligent regarding the design or manufacture of the part. ON Semiconductor is an Equal Opportunity/Affirmative Action Employer. This literature is subject to all applicable copyright laws and is not for resale in any manner.

PUBLICATION ORDERING INFORMATION

LITERATURE FULFILLMENT:

Literature Distribution Center for ON Semiconductor
19521 E. 32nd Pkwy, Aurora, Colorado 80011 USA
Phone: 303-675-2175 or 800-344-3860 Toll Free USA/Canada
Fax: 303-675-2176 or 800-344-3867 Toll Free USA/Canada
Email: orderlit@onsemi.com

N. American Technical Support: 800-282-9855 Toll Free
USA/Canada
Europe, Middle East and Africa Technical Support:
Phone: 421 33 790 2910
Japan Customer Focus Center
Phone: 81-3-5817-1050

ON Semiconductor Website: www.onsemi.com
Order Literature: <http://www.onsemi.com/orderlit>
For additional information, please contact your local
Sales Representative

Looking for pricing, stock, or lifecycle information?

Click below to explore more details on WIN SOURCE:

- [View 4N29TM on WIN SOURCE](#)
- [Fairchild/ON Semiconductor Information](#)

Optimize Your Supply Chain with WIN SOURCE Solutions

- ✓ Global Sourcing Solution
- ✓ Obsolete Management
- ✓ Cost Control Management
- ✓ Shortage Management
- ✓ Alternative Solution
- ✓ Excess Inventory Management