

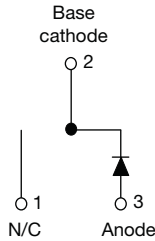
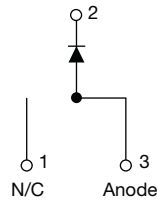

## Hyperfast Rectifier, 8 A FRED Pt®

**TO-263AB (D²PAK)**

**TO-262AA**

**VS-8ETH03SPbF**

**VS-8ETH03-1PbF**

### FEATURES

- Hyperfast recovery time
- Low forward voltage drop
- Low leakage current
- 175 °C operating junction temperature
- Meets MSL level 1, per J-STD-020, LF maximum peak of 260 °C
- AEC-Q101 qualified
- Material categorization: for definitions of compliance please see [www.vishay.com/doc?99912](http://www.vishay.com/doc?99912)

**RoHS**  
 COMPLIANT  
 HALOGEN  
**FREE**

### DESCRIPTION / APPLICATIONS

Vishay Semiconductors 300 V series are the state of the art hyperfast recovery rectifiers designed with optimized performance of forward voltage drop and hyperfast recovery time.

The planar structure and the platinum doped life time control guarantee the best overall performance, ruggedness and reliability characteristics.

These devices are intended for use in the output rectification stage of SMPS, UPS, DC/DC converters as well as freewheeling diodes in low voltage inverters and chopper motor drives.

Their extremely optimized stored charge and low recovery current minimize the switching losses and reduce over dissipation in the switching element and snubbers.

### PRODUCT SUMMARY

Package	TO-263AB (D²PAK), TO-262AA
$I_{F(AV)}$	8 A
$V_R$	300 V
$V_F$ at $I_F$	0.83 V
$t_{rr}$	35 ns
$T_J$ max.	175 °C
Diode variation	Single die

### ABSOLUTE MAXIMUM RATINGS

PARAMETER	SYMBOL	TEST CONDITIONS	MAX.	UNITS
Repetitive peak reverse voltage	$V_{RRM}$		300	V
Average rectified forward current	$I_{F(AV)}$	$T_C = 155\text{ °C}$	8	A
Non-repetitive peak surge current	$I_{FSM}$	$T_C = 25\text{ °C}$	100	
Operating junction and storage temperatures	$T_J, T_{Stg}$		-65 to +175	°C

### ELECTRICAL SPECIFICATIONS ( $T_J = 25\text{ °C}$ unless otherwise specified)

PARAMETER	SYMBOL	TEST CONDITIONS	MIN.	TYP.	MAX.	UNITS
Breakdown voltage, blocking voltage	$V_{BR}, V_R$	$I_R = 100\ \mu\text{A}$	300	-	-	V
Forward voltage	$V_F$	$I_F = 8\text{ A}$ $I_F = 8\text{ A}, T_J = 125\text{ °C}$	-	1.0 0.83	1.25 1.00	
Reverse leakage current	$I_R$	$V_R = V_R$ rated $T_J = 125\text{ °C}, V_R = V_R$ rated	-	0.02 6.0	20 200	$\mu\text{A}$
Junction capacitance	$C_T$	$V_R = 300\text{ V}$	-	31	-	pF
Series inductance	$L_S$	Measured lead to lead 5 mm from package body	-	8	-	nH



DYNAMIC RECOVERY CHARACTERISTICS ( $T_C = 25\text{ }^\circ\text{C}$ unless otherwise specified)							
PARAMETER	SYMBOL	TEST CONDITIONS	MIN.	TYP.	MAX.	UNITS	
Reverse recovery time	$t_{rr}$	$I_F = 1\text{ A}$ , $di_F/dt = -50\text{ A}/\mu\text{s}$ , $V_R = 30\text{ V}$	-	-	35	ns	
		$T_J = 25\text{ }^\circ\text{C}$	-	27	-		
		$T_J = 125\text{ }^\circ\text{C}$	-	40	-		
Peak recovery current	$I_{RRM}$	$I_F = 8\text{ A}$ $di_F/dt = -200\text{ A}/\mu\text{s}$ $V_R = 200\text{ V}$	$T_J = 25\text{ }^\circ\text{C}$	-	2.2	-	A
			$T_J = 125\text{ }^\circ\text{C}$	-	5.3	-	
Reverse recovery charge	$Q_{rr}$		$T_J = 25\text{ }^\circ\text{C}$	-	30	-	nC
			$T_J = 125\text{ }^\circ\text{C}$	-	106	-	

THERMAL - MECHANICAL SPECIFICATIONS						
PARAMETER	SYMBOL	TEST CONDITIONS	MIN.	TYP.	MAX.	UNITS
Maximum junction and storage temperature range	$T_J, T_{Stg}$		-65	-	175	$^\circ\text{C}$
Thermal resistance, junction to case per leg	$R_{thJC}$		-	1.45	2.5	$^\circ\text{C}/\text{W}$
Thermal resistance, junction to ambient per leg	$R_{thJA}$	Typical socket mount	-	-	70	
Thermal resistance, case to heatsink	$R_{thCS}$	Mounting surface, flat, smooth and greased	-	0.2	-	
Weight			-	2.0	-	g
			-	0.07	-	oz.
Mounting torque			6.0 (5.0)	-	12 (10)	kgf · cm (lbf · in)
Marking device		Case style TO-263AB (D <sup>2</sup> PAK)	8ETH03S			
		Case style TO-262	8ETH03-1			

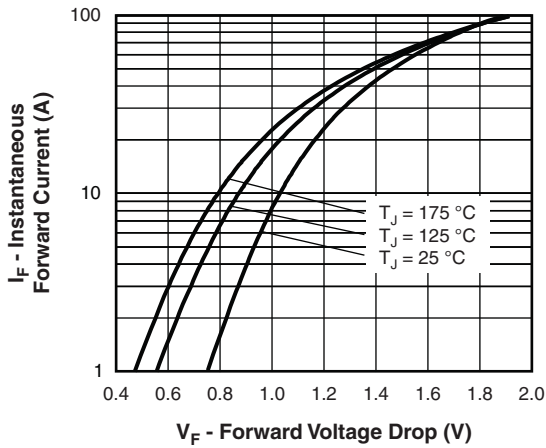

Fig. 1 - Typical Forward Voltage Drop Characteristics

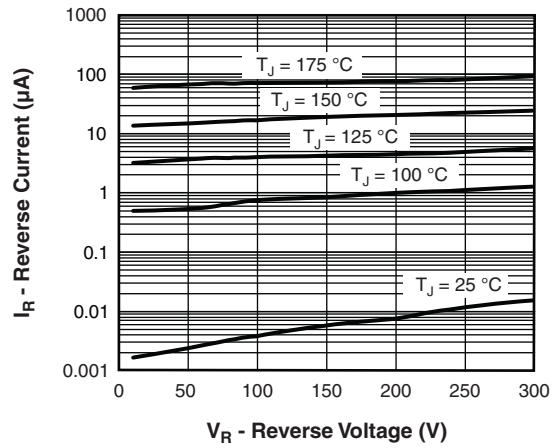

Fig. 2 - Typical Values of Reverse Current vs. Reverse Voltage

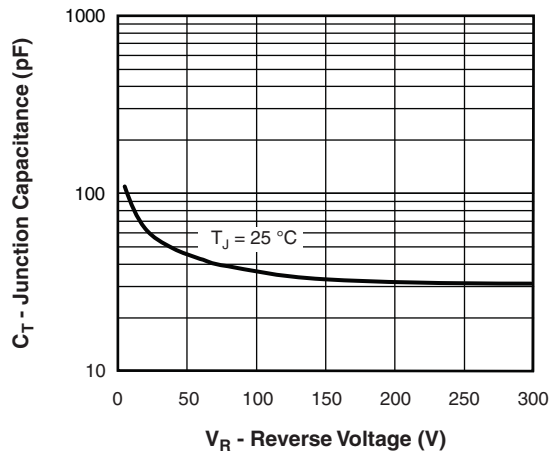

Fig. 3 - Typical Junction Capacitance vs. Reverse Voltage

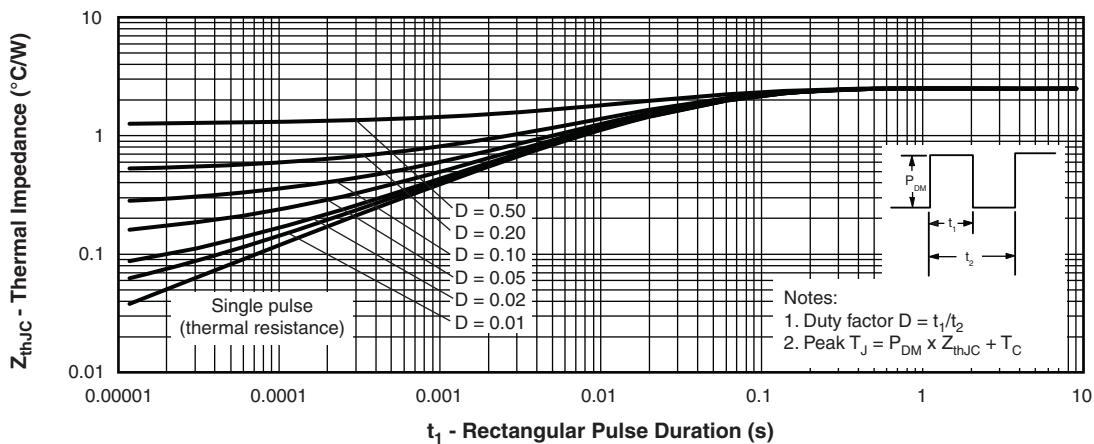

Fig. 4 - Maximum Thermal Impedance  $Z_{thJC}$  Characteristics

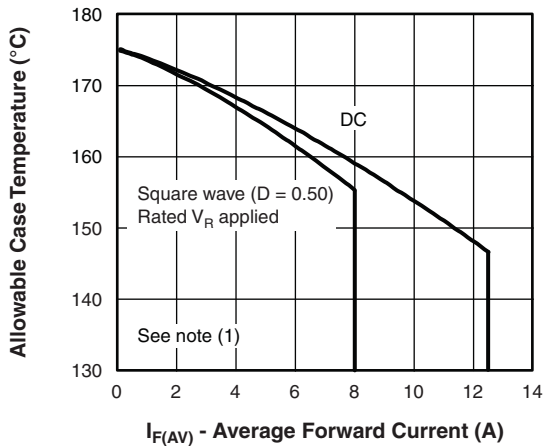

Fig. 5 - Maximum Allowable Case Temperature vs. Average Forward Current

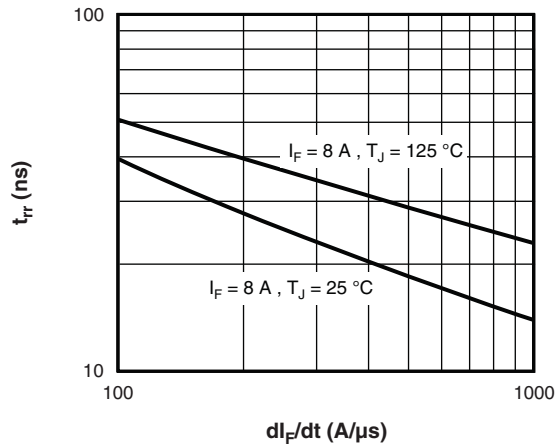

Fig. 7 - Typical Reverse Recovery Time vs.  $dI_F/dt$

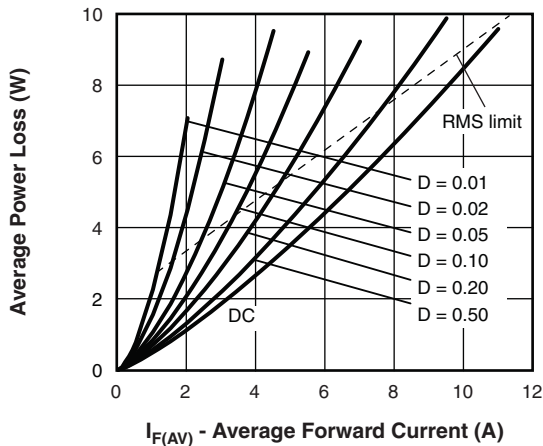

Fig. 6 - Forward Power Loss Characteristics

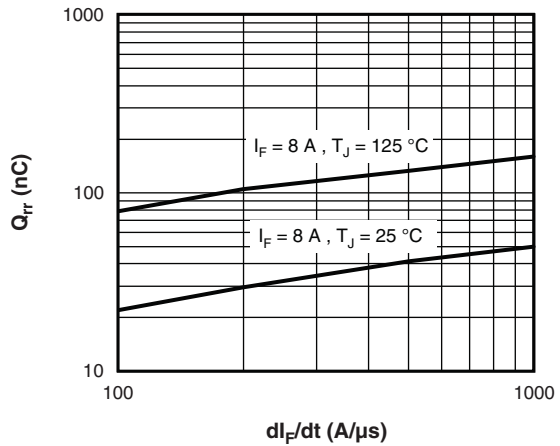

Fig. 8 - Typical Stored Charge vs.  $dI_F/dt$

**Note**

- (1) Formula used:  $T_C = T_J - (P_d + P_{dREV}) \times R_{thJC}$ ;
- $P_d$  = Forward power loss =  $I_{F(AV)} \times V_{FM}$  at  $(I_{F(AV)}/D)$  (see fig. 6);
- $P_{dREV}$  = Inverse power loss =  $V_{R1} \times I_R (1 - D)$ ;  $I_R$  at  $V_{R1} = \text{Rated } V_R$

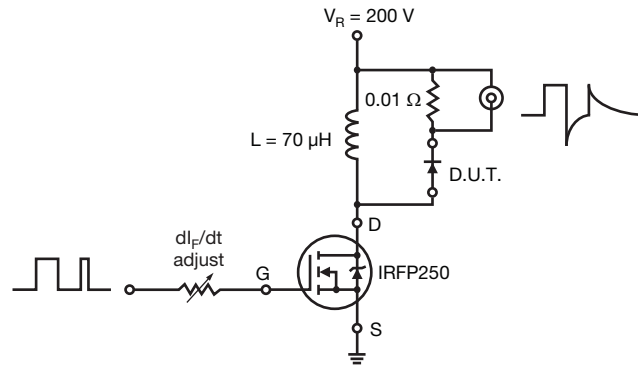
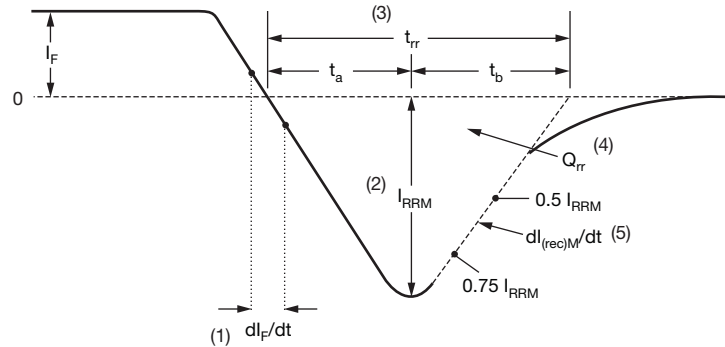

Fig. 9 - Reverse Recovery Parameter Test Circuit



- (1)  $di_F/dt$  - rate of change of current through zero crossing
- (2)  $I_{RRM}$  - peak reverse recovery current
- (3)  $t_{rr}$  - reverse recovery time measured from zero crossing point of negative going  $I_F$  to point where a line passing through  $0.75 I_{RRM}$  and  $0.50 I_{RRM}$  extrapolated to zero current.
- (4)  $Q_{rr}$  - area under curve defined by  $t_{rr}$  and  $I_{RRM}$
- (5)  $dl_{(rec)M}/dt$  - peak rate of change of current during  $t_b$  portion of  $t_{rr}$

$$Q_{rr} = \frac{t_{rr} \times I_{RRM}}{2}$$

Fig. 10 - Reverse Recovery Waveform and Definitions



## ORDERING INFORMATION TABLE

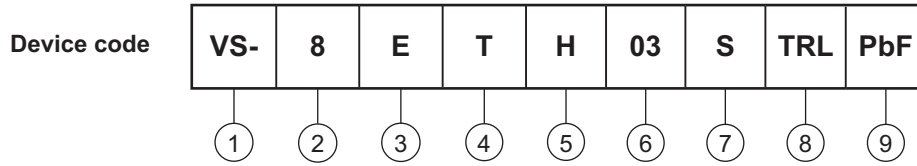

- 1** - Vishay Semiconductors product
- 2** - Current rating (8 A)
- 3** - E = single diode
- 4** - T = TO-220, D<sup>2</sup>PAK
- 5** - H = hyperfast rectifier
- 6** - Voltage rating (03 = 300 V)
- 7** -
  - S = D<sup>2</sup>PAK
  - -1 = TO-262
- 8** -
  - None = tube (50 pieces)
  - TRL = tape and reel (left oriented, for D<sup>2</sup>PAK package)
  - TRR = tape and reel (right oriented, for D<sup>2</sup>PAK package)
- 9** - PbF = lead (Pb)-free

LINKS TO RELATED DOCUMENTS	
Dimensions	<a href="http://www.vishay.com/doc?95014">www.vishay.com/doc?95014</a>
Part marking information	<a href="http://www.vishay.com/doc?95008">www.vishay.com/doc?95008</a>
Packaging information	<a href="http://www.vishay.com/doc?95032">www.vishay.com/doc?95032</a>

## D<sup>2</sup>PAK, TO-262

### DIMENSIONS - D<sup>2</sup>PAK in millimeters and inches

Conforms to JEDEC outline D<sup>2</sup>PAK (SMD-220)

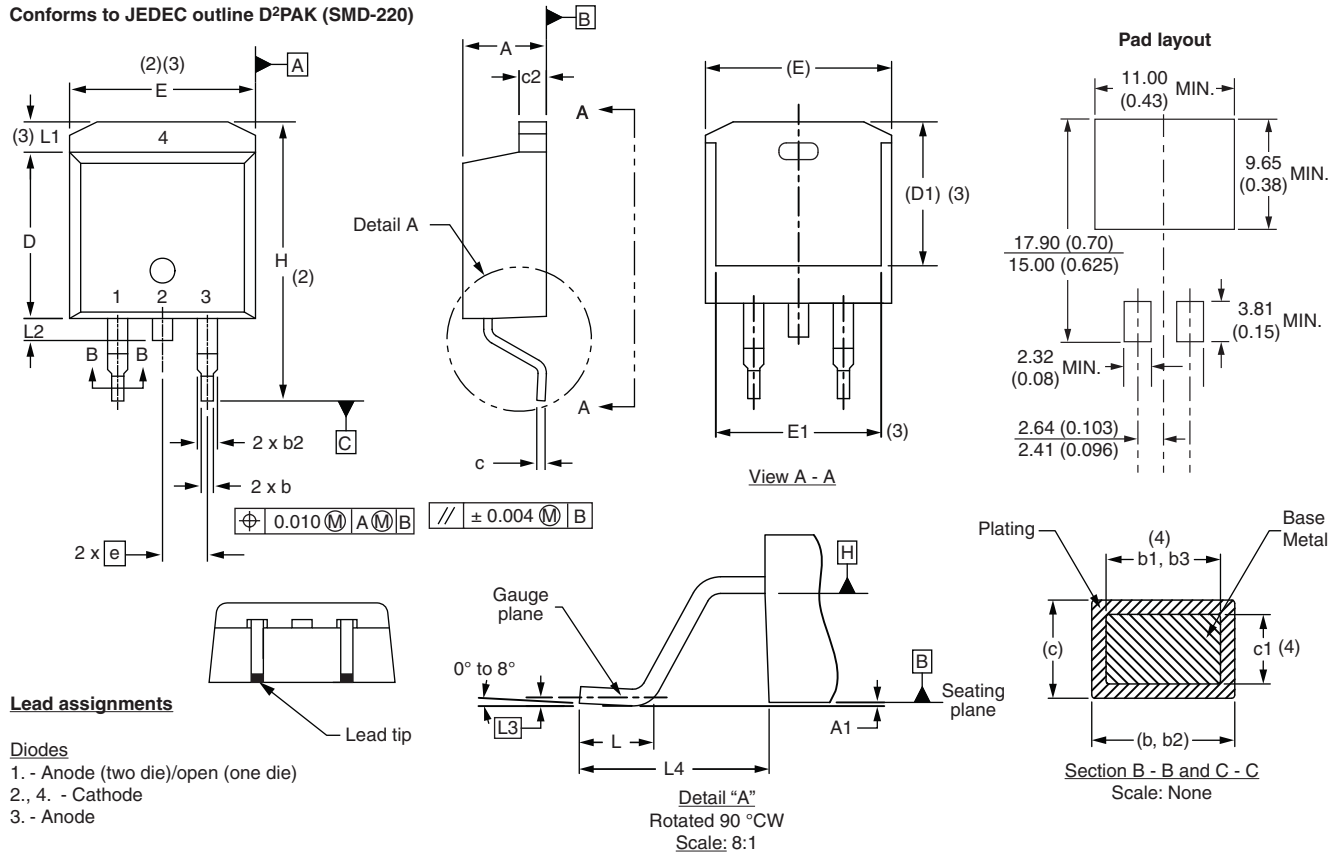

SYMBOL	MILLIMETERS		INCHES		NOTES
	MIN.	MAX.	MIN.	MAX.	
A	4.06	4.83	0.160	0.190	
A1	0.00	0.254	0.000	0.010	
b	0.51	0.99	0.020	0.039	
b1	0.51	0.89	0.020	0.035	4
b2	1.14	1.78	0.045	0.070	
b3	1.14	1.73	0.045	0.068	4
c	0.38	0.74	0.015	0.029	
c1	0.38	0.58	0.015	0.023	4
c2	1.14	1.65	0.045	0.065	
D	8.51	9.65	0.335	0.380	2

SYMBOL	MILLIMETERS		INCHES		NOTES
	MIN.	MAX.	MIN.	MAX.	
D1	6.86	8.00	0.270	0.315	3
E	9.65	10.67	0.380	0.420	2, 3
E1	7.90	8.80	0.311	0.346	3
e	2.54 BSC		0.100 BSC		
H	14.61	15.88	0.575	0.625	
L	1.78	2.79	0.070	0.110	
L1	-	1.65	-	0.066	3
L2	1.27	1.78	0.050	0.070	
L3	0.25 BSC		0.010 BSC		
L4	4.78	5.28	0.188	0.208	

#### Notes

- (1) Dimensioning and tolerancing per ASME Y14.5 M-1994
- (2) Dimension D and E do not include mold flash. Mold flash shall not exceed 0.127 mm (0.005") per side. These dimensions are measured at the outmost extremes of the plastic body
- (3) Thermal pad contour optional within dimension E, L1, D1 and E1
- (4) Dimension b1 and c1 apply to base metal only
- (5) Datum A and B to be determined at datum plane H
- (6) Controlling dimension: inch

- (7) Outline conforms to JEDEC outline TO-263AB

## DIMENSIONS - TO-262 in millimeters and inches

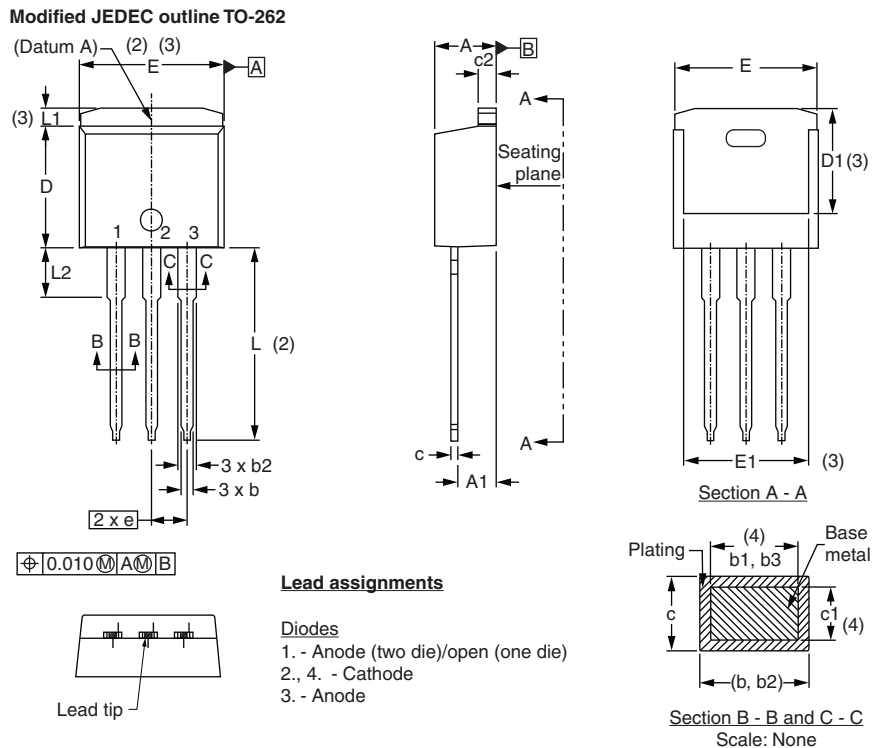

SYMBOL	MILLIMETERS		INCHES		NOTES
	MIN.	MAX.	MIN.	MAX.	
A	4.06	4.83	0.160	0.190	
A1	2.03	3.02	0.080	0.119	
b	0.51	0.99	0.020	0.039	
b1	0.51	0.89	0.020	0.035	4
b2	1.14	1.78	0.045	0.070	
b3	1.14	1.73	0.045	0.068	4
c	0.38	0.74	0.015	0.029	
c1	0.38	0.58	0.015	0.023	4
c2	1.14	1.65	0.045	0.065	
D	8.51	9.65	0.335	0.380	2
D1	6.86	8.00	0.270	0.315	3
E	9.65	10.67	0.380	0.420	2, 3
E1	7.90	8.80	0.311	0.346	3
e	2.54 BSC		0.100 BSC		
L	13.46	14.10	0.530	0.555	
L1	-	1.65	-	0.065	3
L2	3.56	3.71	0.140	0.146	

### Notes

- (1) Dimensioning and tolerancing as per ASME Y14.5M-1994
- (2) Dimension D and E do not include mold flash. Mold flash shall not exceed 0.127 mm (0.005") per side. These dimensions are measured at the outmost extremes of the plastic body
- (3) Thermal pad contour optional within dimension E, L1, D1 and E1
- (4) Dimension b1 and c1 apply to base metal only
- (5) Controlling dimension: inches
- (6) Outline conform to JEDEC TO-262 except A1 (maximum), b (minimum) and D1 (minimum) where dimensions derived the actual package outline



## **Disclaimer**

ALL PRODUCT, PRODUCT SPECIFICATIONS AND DATA ARE SUBJECT TO CHANGE WITHOUT NOTICE TO IMPROVE RELIABILITY, FUNCTION OR DESIGN OR OTHERWISE.

Vishay Intertechnology, Inc., its affiliates, agents, and employees, and all persons acting on its or their behalf (collectively, "Vishay"), disclaim any and all liability for any errors, inaccuracies or incompleteness contained in any datasheet or in any other disclosure relating to any product.

Vishay makes no warranty, representation or guarantee regarding the suitability of the products for any particular purpose or the continuing production of any product. To the maximum extent permitted by applicable law, Vishay disclaims (i) any and all liability arising out of the application or use of any product, (ii) any and all liability, including without limitation special, consequential or incidental damages, and (iii) any and all implied warranties, including warranties of fitness for particular purpose, non-infringement and merchantability.

Statements regarding the suitability of products for certain types of applications are based on Vishay's knowledge of typical requirements that are often placed on Vishay products in generic applications. Such statements are not binding statements about the suitability of products for a particular application. It is the customer's responsibility to validate that a particular product with the properties described in the product specification is suitable for use in a particular application. Parameters provided in datasheets and / or specifications may vary in different applications and performance may vary over time. All operating parameters, including typical parameters, must be validated for each customer application by the customer's technical experts. Product specifications do not expand or otherwise modify Vishay's terms and conditions of purchase, including but not limited to the warranty expressed therein.

Except as expressly indicated in writing, Vishay products are not designed for use in medical, life-saving, or life-sustaining applications or for any other application in which the failure of the Vishay product could result in personal injury or death. Customers using or selling Vishay products not expressly indicated for use in such applications do so at their own risk. Please contact authorized Vishay personnel to obtain written terms and conditions regarding products designed for such applications.

No license, express or implied, by estoppel or otherwise, to any intellectual property rights is granted by this document or by any conduct of Vishay. Product names and markings noted herein may be trademarks of their respective owners.

## Looking for pricing, stock, or lifecycle information?

Click below to explore more details on WIN SOURCE:

⊖ [View VS-8ETH03STRLPBF on WIN SOURCE](#)

⊖ [Vishay Information](#)

## Optimize Your Supply Chain with WIN SOURCE Solutions

- ✓ Global Sourcing Solution
- ✓ Obsolete Management
- ✓ Cost Control Management
- ✓ Shortage Management
- ✓ Alternative Solution
- ✓ Excess Inventory Management