

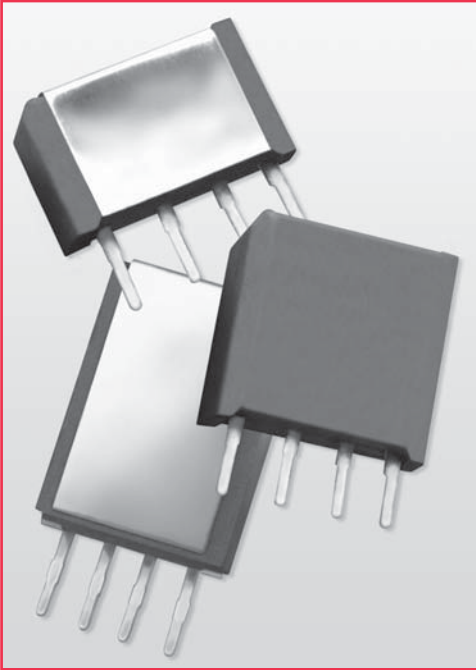

THE DATASHEET OF
2636087



9011, 9012 & 9117 Miniature SIP Relays



Miniature Molded SIP Reed Relays

The 9012 package dimensions are 47% smaller than standard 9000 SIPs, yet the relay retains the 10W switch ratings of its larger counterparts. The 9011 package dimensions are 65% smaller than the standard 9000 SIPs and incorporates Coto's 7mm switch rated at 3W. The 9117 goes one step further, reducing package size by 65% from standard 9000 SIPs. This is the smallest SIP footprint with a 3W rating. These miniature SIP relays are ideal for use in ATE applications and other high reliability test, measurement and telecommunications applications where high board density and long life are key requirements.

Series Features

- ◆ 9012 is a 10W SIP relay (.400" x .150" x .400")
- ◆ 9011 is a 3W SIP relay (.400" x .150" x .265")
- ◆ 9117 is the smallest 3W SIP relay (.270" x .150" x .385")
- ◆ Magnetic shielding reduces interaction
- ◆ Optional coil suppression diode protects coil drive circuits
- ◆ UL File # E67117 (9117 UL Pending)
- ◆ High insulation resistance $10^{12} \Omega$ minimum.
- ◆ High speed switching
- ◆ Molded thermoset body on integral lead frame design
- ◆ High reliability, hermetically sealed contacts for long life

Model 9011

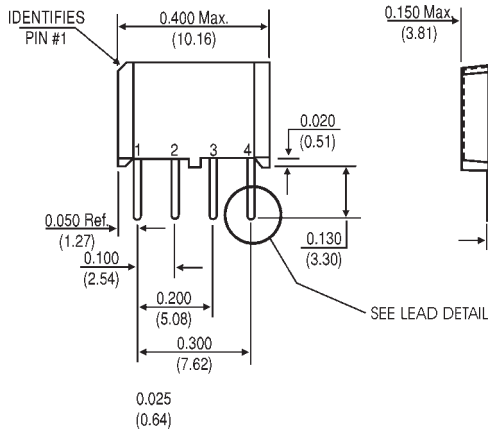

Dimensions in Inches (Millimeters)

Model 9012

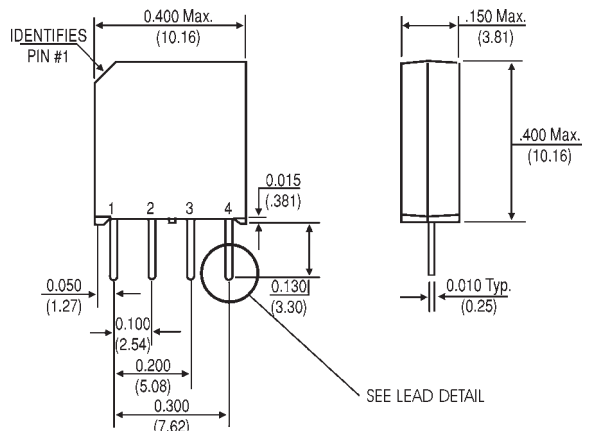

Model 9117

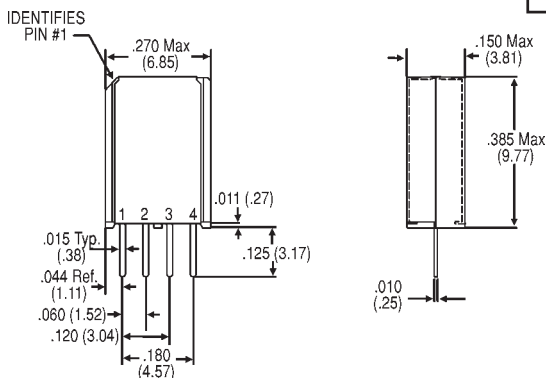

Ordering Information

Part Number	90XX-XX-1X
Model Number	9011 9012 9117
Coil Voltage	05 = 5 volts 12 = 12 volts (N/A on 9117)
Magnetic Shield	1 = Mag Shield (External 9011, 9117; Internal 9012)
General Options ²	0 = No Diode 1 = Diode

9011, 9012 & 9117 Miniature SIP Relays

Model Number			9011 ^{2,4} (3 Watt)	9012 ^{2,4} (10 Watt)	9117 ^{2,4} (3 Watt)
Parameters	Test Conditions	Units	4 Pin SIP	4 Pin SIP	Narrow Fit
COIL SPECS.					
Nom. Coil Voltage		VDC	5 12	5 12	5
Max. Coil Voltage		VDC	6.5 15.0	6.5 15.0	6.0
Coil Resistance	+/- 10%, 25° C	Ω	500 750	500 750	400
Operate Voltage	Must Operate by	VDC - Max.	3.75 9.0	3.75 9.0	3.75
Release Voltage	Must Release by	VDC - Min.	0.4 1.0	0.4 1.0	0.5
CONTACT RATINGS					
Switching Voltage	Max DC/Peak AC Resist.	Volts	100	200	100
Switching Current	Max DC/Peak AC Resist.	Amps	0.250	0.5	0.25
Carry Current	Max DC/Peak AC Resist.	Amps	0.5	1.5	0.5
Contact Rating	Max DC/Peak AC Resist.	Watts	3	10	3
Life Expectancy-Typical ¹	Signal Level 1.0V, 10mA	x 10 ⁶ Ops.	250	1000	250
Static Contact Resistance (max. init.)	50mV, 10mA	Ω	0.150	0.120	0.120
Dynamic Contact Resistance (max. init.)	0.5V, 50mA at 100 Hz, 1.5 msec	Ω	0.200	0.200	0.200
RELAY SPECIFICATIONS					
Insulation Resistance (minimum)	Between all Isolated Pins at 100V, 25°C, 40% RH	Ω	10 ¹²	10 ¹²	10 ¹²
Capacitance - Typical Across Open Contacts		pF	0.7	0.7	0.14
Open Contact to Coil		pF	1.4	1.4	N/A
Dielectric Strength (minimum)	Between Contacts	VDC/peak AC	200	300	150
	Contacts to Coil	VDC/peak AC	1500	1500	1500
Operate Time - including bounce - Typical	At Nominal Coil Voltage, 30 Hz Square Wave	msec.	0.35	0.35	0.2
Release Time - Typical	Zener-Diode Suppression ³	msec.	0.1	0.1	0.1



Top View:
Grid = .1"x.1" (2.54mm x 2.54mm)

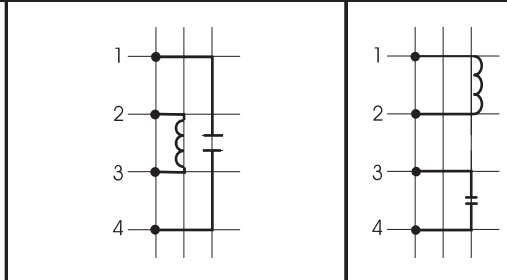

Notes:

¹Consult factory for life expectancy at other switching loads. Resistance >0.5Ω defines end of life or failure to open.

²Optional diode is connected to pin #2 (+) and pin #3(-) for 9011 & 9012; pin #1(+) and pin #2(-) for 9117. Correct coil polarity must be observed.

³Consists of 20V Zener-diode and 1N1002 diode in series, connected in parallel with coil.

⁴9011 & 9117 external mag shield. 9012 internal mag shield.

Environmental Ratings:

Storage Temp: -35°C to +100°C; Operating Temp: -20°C to +85°C
Solder Temp: 270°C max; 10 sec. max

The operate and release voltage and the coil resistance are specified at 25°C. These values vary by approximately 0.4%/°C as the ambient temperature varies.

Vibration: 20 G's to 2000 Hz; Shock: 50 G's

Looking for pricing, stock, or lifecycle information?

Click below to explore more details on WIN SOURCE:

 [View 2636087](#) on WIN SOURCE

 [Coto Technology](#) Information

Optimize Your Supply Chain with WIN SOURCE Solutions

-  Global Sourcing Solution
-  Obsolete Management
-  Cost Control Management
-  Shortage Management
-  Alternative Solution
-  Excess Inventory Management