



**THE DATASHEET OF
ADR1581BRTZ-R2**



FEATURES

- Wide operating range: 60 μ A to 10 mA
- Initial accuracy: $\pm 0.12\%$ maximum
- Temperature drift: ± 50 ppm/ $^{\circ}$ C maximum
- Output impedance: 0.5 Ω maximum
- Wideband noise (10 Hz to 10 kHz): 20 μ V rms
- Operating temperature range: -40° C to $+85^{\circ}$ C
- High ESD rating
 - 4 kV human body model
 - 400 V machine model
- Compact, surface-mount SOT-23 package

APPLICATIONS

- Portable, battery-powered equipment
 - Cellular phones, notebook computers, PDAs, GPSs, and DMMs
- Computer workstations
 - Suitable for use with a wide range of video RAMDACs
- Smart industrial transmitters
- PCMCIA cards
- Automotive
- 3 V/5 V, 8-bit to 12-bit data converters

GENERAL DESCRIPTION

The ADR1581¹ is a low cost, 2-terminal (shunt), precision band gap reference. It provides an accurate 1.25 V output for input currents between 60 μ A and 10 mA.

The superior accuracy and stability of the ADR1581 is made possible by the precise matching and thermal tracking of on-chip components. Proprietary curvature correction design techniques have been used to minimize the nonlinearities in the voltage output temperature characteristics. The ADR1581 is stable with any value of capacitive load.

The low minimum operating current makes the ADR1581 ideal for use in battery-powered 3 V or 5 V systems. However, the wide operating current range means that the ADR1581 is extremely versatile and suitable for use in a wide variety of high current applications.

The ADR1581 is available in two grades, A and B, both of which are provided in the SOT-23 package. Both grades are specified over the industrial temperature range of -40° C to $+85^{\circ}$ C.

¹ Protected by U.S. Patent No. 5,969,657.

Rev. 0

Information furnished by Analog Devices is believed to be accurate and reliable. However, no responsibility is assumed by Analog Devices for its use, nor for any infringements of patents or other rights of third parties that may result from its use. Specifications subject to change without notice. No license is granted by implication or otherwise under any patent or patent rights of Analog Devices. Trademarks and registered trademarks are the property of their respective owners.

PIN CONFIGURATION

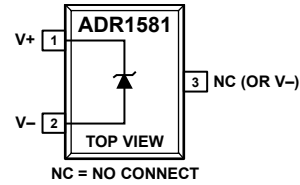

Figure 1. SOT-23

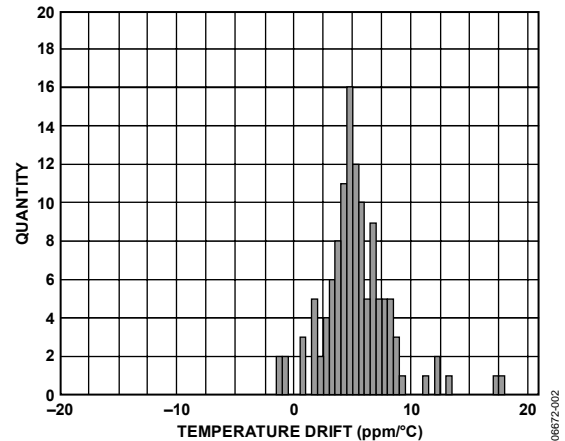

Figure 2. Reverse Voltage Temperature Drift Distribution

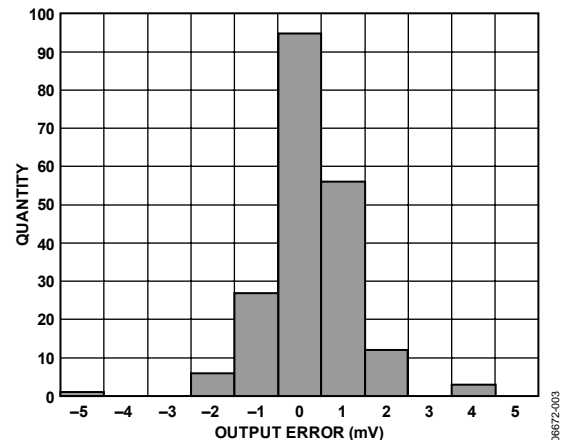

Figure 3. Reverse Voltage Error Distribution

TABLE OF CONTENTS

Features	1	Temperature Performance.....	6
Applications.....	1	Voltage Output Nonlinearity vs. Temperature	7
General Description	1	Reverse Voltage Hysteresis.....	7
Pin Configuration.....	1	Output Impedance vs. Frequency	8
Revision History	2	Noise Performance and Reduction	8
Specifications.....	3	Turn-On Time	8
Absolute Maximum Ratings.....	4	Transient Response	9
ESD Caution.....	4	Precision Micropower Low Dropout Reference	9
Typical Performance Characteristics	5	Using the ADR1581 with 3 V Data Converters	10
Theory of Operation	6	Outline Dimensions	11
Applying the ADR1581.....	6	Ordering Guide	12

REVISION HISTORY

5/07—Revision 0: Initial Version

SPECIFICATIONS

$T_A = 25^\circ\text{C}$, $I_{IN} = 100\ \mu\text{A}$, unless otherwise noted.

Table 1.

Parameter	ADR1581A			ADR1581B			Unit
	Min	Typ	Max	Min	Typ	Max	
REVERSE VOLTAGE OUTPUT (SOT-23)	1.240	1.250	1.260	1.2485	1.250	1.2515	V
REVERSE VOLTAGE TEMPERATURE DRIFT –40°C to +85°C			100			50	ppm/°C
MINIMUM OPERATING CURRENT, T_{MIN} to T_{MAX}			60			60	μA
REVERSE VOLTAGE CHANGE WITH REVERSE CURRENT 60 $\mu\text{A} < I_{IN} < 10\ \text{mA}$, T_{MIN} to T_{MAX}		2.5	6		2.5	6	mV
60 $\mu\text{A} < I_{IN} < 1\ \text{mA}$, T_{MIN} to T_{MAX}		0.8			0.8		mV
DYNAMIC OUTPUT IMPEDANCE ($\Delta V_R / \Delta I_R$) $I_{IN} = 1\ \text{mA} \pm 100\ \mu\text{A}$ ($f = 120\ \text{Hz}$)		0.4	1		0.4	0.5	Ω
OUTPUT NOISE RMS Noise Voltage: 10 Hz to 10 kHz		20			20		$\mu\text{V rms}$
Low Frequency Noise Voltage: 0.1 Hz to 10 Hz		4.5			4.5		$\mu\text{V p-p}$
TURN-ON SETTLING TIME TO 0.1% ¹		5			5		μs
OUTPUT VOLTAGE HYSTERESIS ²		80			80		μV
TEMPERATURE RANGE Specified Performance, T_{MIN} to T_{MAX}	–40		+85	–40		+85	°C
Operating Range ³	–55		+125	–55		+125	°C

¹ Measured with a no load capacitor.

² Output hysteresis is defined as the change in the +25°C output voltage after a temperature excursion to –40°C, then to +85°C, and back to +25°C.

³ The operating temperature range is defined as the temperature extremes at which the device continues to function. Parts may deviate from their specified performance.

ABSOLUTE MAXIMUM RATINGS

Table 2.

Parameter	Rating
Reverse Current	25 mA
Forward Current	20 mA
Internal Power Dissipation ¹ SOT-23 (RT)	0.3 W
Storage Temperature Range	–65°C to +150°C
Operating Temperature Range ADR1581/RT	–55°C to +125°C
Lead Temperature, Soldering Vapor Phase (60 sec)	215°C
Infrared (15 sec)	220°C
ESD Susceptibility ² Human Body Model	4 kV
Machine Model	400 V

¹ Specification is for device (SOT-23 package) in free air at 25°C: $\theta_{JA} = 300^{\circ}\text{C}/\text{W}$.

² The human body model is a 100 pF capacitor discharged through 1.5 k Ω . For the machine model, a 200 pF capacitor is discharged directly into the device.

Stresses above those listed under Absolute Maximum Ratings may cause permanent damage to the device. This is a stress rating only; functional operation of the device at these or any other conditions above those indicated in the operational section of this specification is not implied. Exposure to absolute maximum rating conditions for extended periods may affect device reliability.

ESD CAUTION



ESD (electrostatic discharge) sensitive device. Charged devices and circuit boards can discharge without detection. Although this product features patented or proprietary protection circuitry, damage may occur on devices subjected to high energy ESD. Therefore, proper ESD precautions should be taken to avoid performance degradation or loss of functionality.

TYPICAL PERFORMANCE CHARACTERISTICS

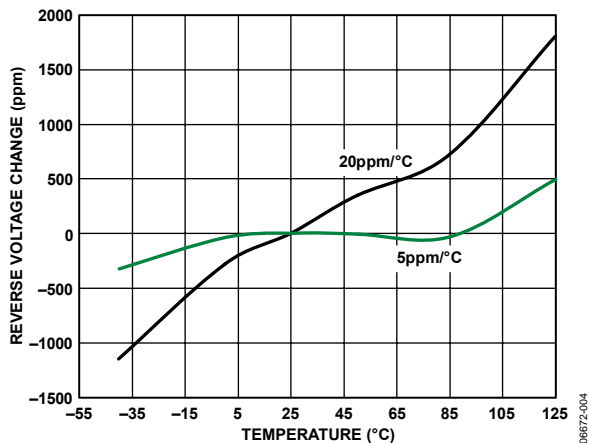

Figure 4. Output Drift for Different Temperature Characteristics

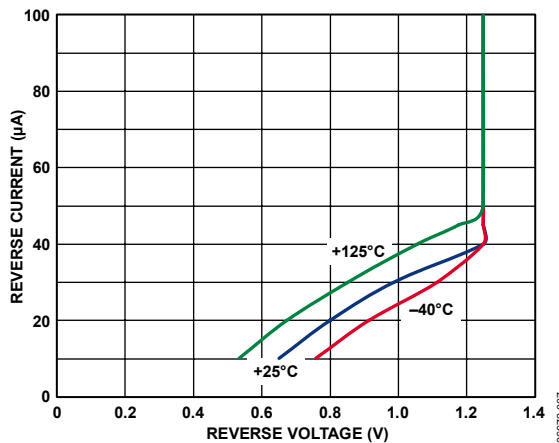

Figure 7. Reverse Current vs. Reverse Voltage

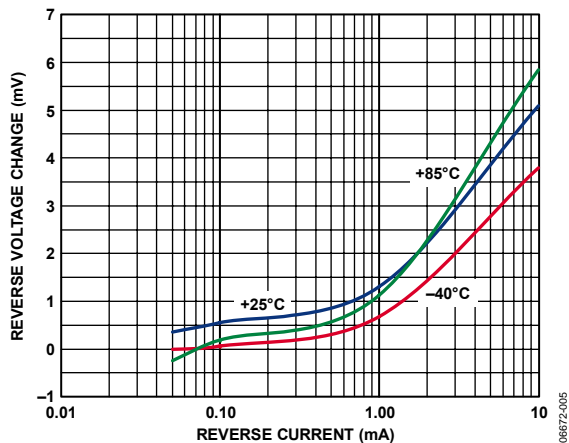

Figure 5. Output Voltage Error vs. Reverse Current

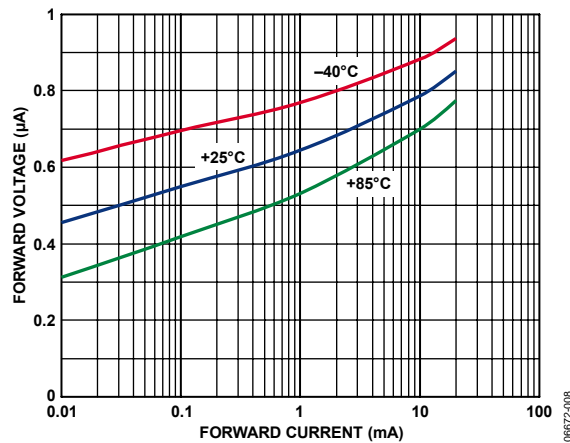

Figure 8. Forward Voltage vs. Forward Current

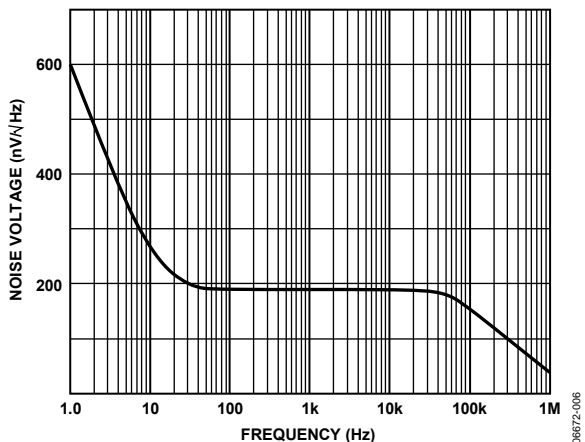

Figure 6. Noise Spectral Density

THEORY OF OPERATION

The ADR1581 uses the band gap concept to produce a stable, low temperature coefficient voltage reference suitable for high accuracy data acquisition components and systems. The device makes use of the underlying physical nature of a silicon transistor base emitter voltage in the forward-biased operating region. All such transistors have an approximately $-2 \text{ mV}/^\circ\text{C}$ temperature coefficient, which is unsuitable for use directly as a low TC reference; however, extrapolation of the temperature characteristic of any one of these devices to absolute zero (with collector current proportional to absolute temperature) reveals that its V_{BE} goes to approximately the silicon band gap voltage. Therefore, if a voltage could be developed with an opposing temperature coefficient to sum with V_{BE} , a zero TC reference would result. The ADR1581 circuit in Figure 9 provides such a compensating voltage, V_1 , by driving two transistors at different current densities and amplifying the resultant V_{BE} difference (ΔV_{BE}), which has a positive TC. The sum of V_{BE} and V_1 provides a stable voltage reference.

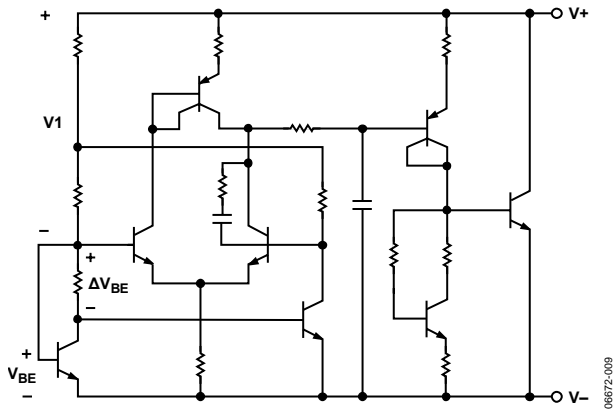

Figure 9. Schematic Diagram

APPLYING THE ADR1581

The ADR1581 is simple to use in virtually all applications. To operate the ADR1581 as a conventional shunt regulator (see Figure 10), an external series resistor is connected between the supply voltage and the ADR1581. For a given supply voltage, the series resistor, R_S , determines the reverse current flowing through the ADR1581. The value of R_S must be chosen to accommodate the expected variations of the supply voltage (V_S), load current (I_L), and the ADR1581 reverse voltage (V_R) while maintaining an acceptable reverse current (I_R) through the ADR1581.

The minimum value for R_S should be chosen when V_S is at its minimum and I_L and V_R are at their maximum while maintaining the minimum acceptable reverse current.

The value of R_S should be large enough to limit I_R to 10 mA when V_S is at its maximum and I_L and V_R are at their minimum.

The equation for selecting R_S is as follows:

$$R_S = (V_S - V_R) / (I_R + I_L)$$

Figure 11 shows a typical connection of the ADR1581BRT operating at a minimum of $100 \mu\text{A}$. This connection can provide $\pm 1 \text{ mA}$ to the load while accommodating $\pm 10\%$ power supply variations.

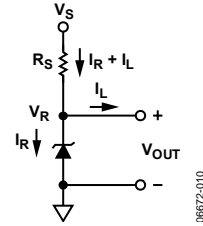

Figure 10. Typical Connection Diagram

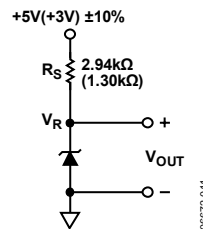

Figure 11. Typical Connection Diagram

TEMPERATURE PERFORMANCE

The ADR1581 is designed for reference applications where stable temperature performance is important. Extensive temperature testing and characterization ensure that the device's performance is maintained over the specified temperature range.

Some confusion exists in the area of defining and specifying reference voltage error over temperature. Historically, references have been characterized using a maximum deviation per degree Celsius, for example, $50 \text{ ppm}/^\circ\text{C}$. However, because of nonlinearities in temperature characteristics that originated in standard Zener references (such as S type characteristics), most manufacturers now use a maximum limit error band approach to specify devices. This technique involves the measurement of the output at three or more temperatures to guarantee that the voltage falls within the given error band. The proprietary curvature correction design techniques used to minimize the ADR1581 nonlinearities allow the temperature performance to be guaranteed using the maximum deviation method. This method is more useful to a designer than one that simply guarantees the maximum error band over the entire temperature change.

Figure 12 shows a typical output voltage drift for the ADR1581 and illustrates the methodology. The maximum slope of the two diagonals drawn from the initial output value at $+25^\circ\text{C}$ to the output values at $+85^\circ\text{C}$ and -40°C determines the performance grade of the device. For a given grade of the ADR1581, the designer can easily determine the maximum total error from the initial tolerance plus the temperature variation.

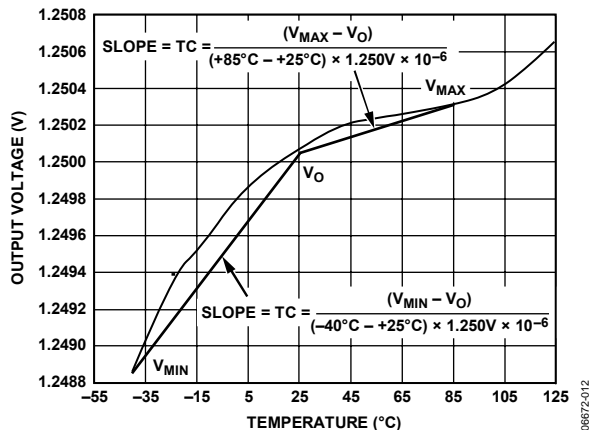

Figure 12. Output Voltage vs. Temperature

For example, the ADR1581BRT initial tolerance is ± 1.5 mV; a ± 50 ppm/ $^{\circ}\text{C}$ temperature coefficient corresponds to an error band of ± 4.1 mV ($50 \times 10^{-6} \times 1.250\text{V} \times 65^{\circ}\text{C}$). Therefore, the unit is guaranteed to be $1.250\text{V} \pm 5.6\text{mV}$ over the operating temperature range.

Duplication of these results requires a combination of high accuracy and stable temperature control in a test system. Evaluation of the ADR1581 produces curves similar to those in Figure 4 and Figure 12.

VOLTAGE OUTPUT NONLINEARITY VS. TEMPERATURE

When a reference is used with data converters, it is important to understand how temperature drift affects the overall converter performance. The nonlinearity of the reference output drift represents additional error that is not easily calibrated out of the system. The usual way of showing the reference output drift is to plot the reference voltage vs. temperature (see Figure 12). An alternative method is to draw a straight line between the temperature endpoints and measure the deviation of the output from the straight line. This shows the same data in a different format. This characteristic (see Figure 13) is generated by normalizing the measured drift characteristic to the endpoint average drift. The residual drift error of approximately 500 ppm shows that the ADR1581 is compatible with systems that require 10-bit accurate temperature performance.

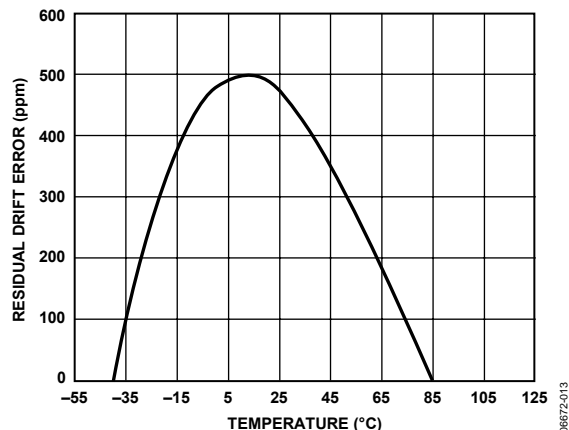

Figure 13. Residual Drift Error

REVERSE VOLTAGE HYSTERESIS

A major requirement for high performance industrial equipment manufacturers is a consistent output voltage at nominal temperature following operation over the operating temperature range. This characteristic is generated by measuring the difference between the output voltage at $+25^{\circ}\text{C}$ after operating at $+85^{\circ}\text{C}$ and the output voltage at $+25^{\circ}\text{C}$ after operating at -40°C . Figure 14 displays the hysteresis associated with the ADR1581. This characteristic exists in all references and has been minimized in the ADR1581.

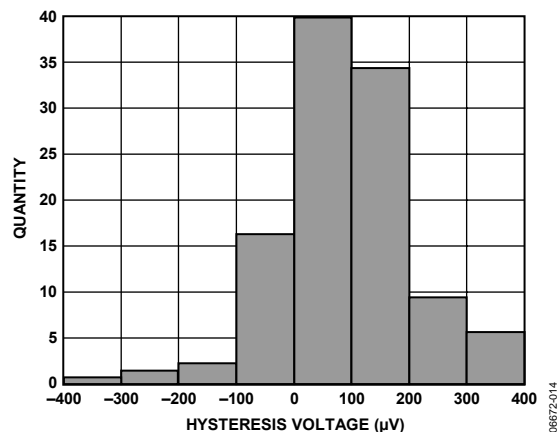

Figure 14. Reverse Voltage Hysteresis Distribution

ADR1581

OUTPUT IMPEDANCE VS. FREQUENCY

Understanding the effect of the reverse dynamic output impedance in a practical application is important to successfully applying the ADR1581. A voltage divider is formed by the ADR1581 output impedance and the external source impedance. When an external source resistor of about 30 kΩ ($I_R = 100 \mu\text{A}$) is used, 1% of the noise from a 100 kHz switching power supply is developed at the output of the ADR1581. Figure 15 shows how a 1 μF load capacitor connected directly across the ADR1581 reduces the effect of power supply noise to less than 0.01%.

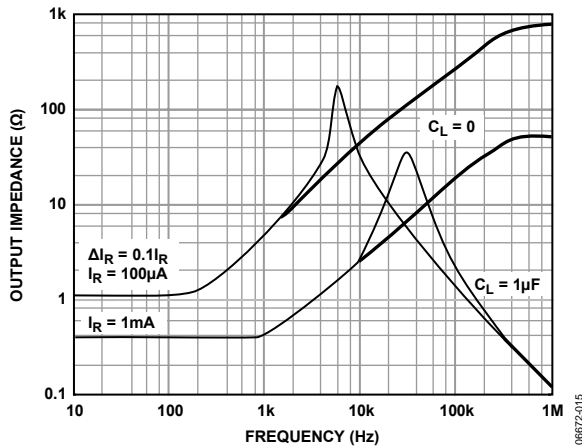

Figure 15. Output Impedance vs. Frequency

NOISE PERFORMANCE AND REDUCTION

The noise generated by the ADR1581 is typically less than 5 μV p-p over the 0.1 Hz to 10 Hz band. Figure 16 shows the 0.1 Hz to 10 Hz noise of a typical ADR1581. Noise in a 10 Hz to 10 kHz bandwidth is approximately 20 μV rms (see Figure 17a). If further noise reduction is desired, a one-pole low-pass filter can be added between the output pin and ground. A time constant of 0.2 ms has a -3 dB point at about 800 Hz and reduces the high frequency noise to about 6.5 μV rms (see Figure 17b). A time constant of 960 ms has a -3 dB point at 165 Hz and reduces the high frequency noise to about 2.9 μV rms (see Figure 17c).

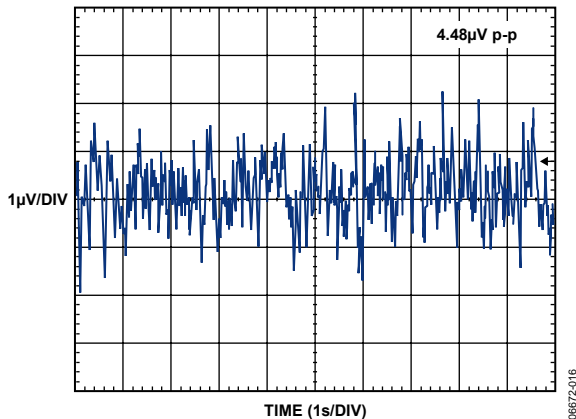

Figure 16. 0.1 Hz to 10 Hz Voltage Noise

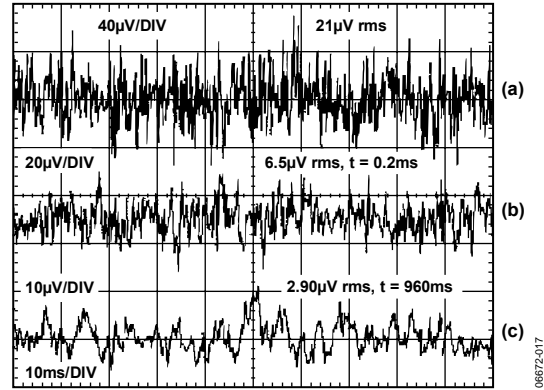

Figure 17. Total RMS Noise

TURN-ON TIME

Many low power instrument manufacturers are becoming increasingly concerned with the turn-on characteristics of the components in their systems. Fast turn-on components often enable the end user to keep power off when not needed, and yet those components respond quickly when the power is turned on for operation. Figure 18 displays the turn-on characteristics of the ADR1581.

Upon application of power (cold start), the time required for the output voltage to reach its final value within a specified error is the turn-on settling time. Two components normally associated with this are time for active circuits to settle and time for thermal gradients on the chip to stabilize. This characteristic is generated from cold start operation and represents the true turn-on waveform after power-up. Figure 20 shows both the coarse and fine turn-on settling characteristics of the device; the total settling time to within 1.0 mV is about 6 μs, and there is no long thermal tail when the horizontal scale is expanded to 2 ms/div.

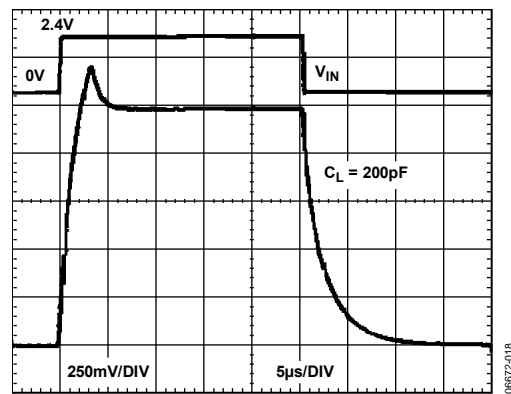

Figure 18. Turn-On Response Time

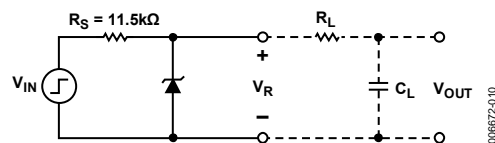

Figure 19. Turn-On, Settling, and Transient Test Circuit

Output turn-on time is modified when an external noise-reduction filter is used. When present, the time constant of the filter dominates the overall settling.

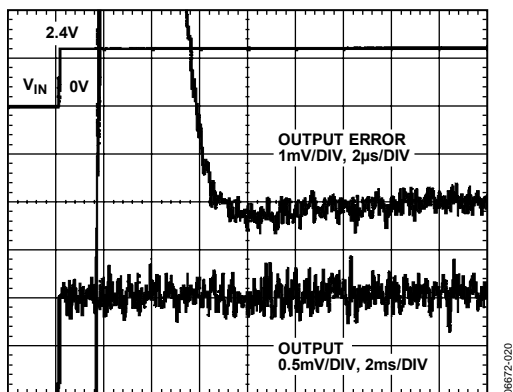

Figure 20. Turn-On Settling

TRANSIENT RESPONSE

Many ADCs and DACs present transient current loads to the reference. Poor reference response can degrade the converter’s performance.

Figure 21 displays both the coarse and fine settling characteristics of the device to load transients of $\pm 50 \mu\text{A}$.

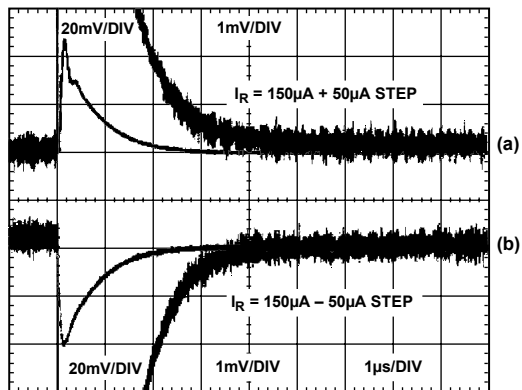

Figure 21. Transient Settling

Figure 21a shows the settling characteristics of the device for an increased reverse current of $50 \mu\text{A}$. Figure 21b shows the response when the reverse current is decreased by $50 \mu\text{A}$. The transients settle to 1 mV in about $3 \mu\text{s}$.

Attempts to drive a large capacitive load (in excess of 1000 pF) may result in ringing, as shown in the step response (see Figure 22). This is due to the additional poles formed by the load capacitance and the output impedance of the reference. A recommended method of driving capacitive loads of this magnitude is shown in Figure 19. A resistor isolates the capacitive load from the output stage, whereas the capacitor provides a single-pole low-pass filter and lowers the output noise.

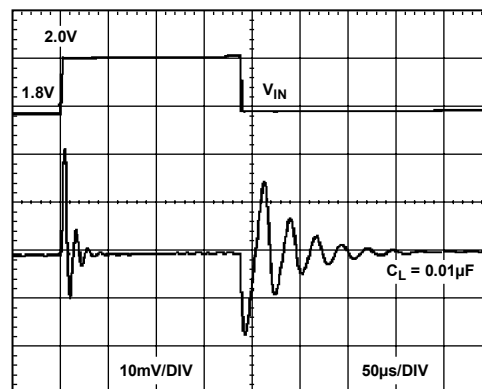

Figure 22. Transient Response with Capacitive Load

PRECISION MICROPOWER LOW DROPOUT REFERENCE

The circuit in Figure 23 provides an ideal solution for creating a stable voltage reference with low standby power consumption, low input/output dropout capability, and minimum noise output. The amplifier both buffers and optionally scales up the ADR1581 output voltage. Output voltages as high as 2.1 V can supply 1 mA of load current. A one-pole filter connected between the ADR1581 and the OP193 input can be used to achieve low output noise. The nominal quiescent power consumption is $250 \mu\text{W}$.

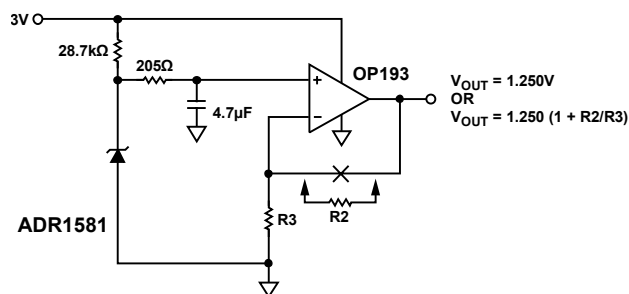
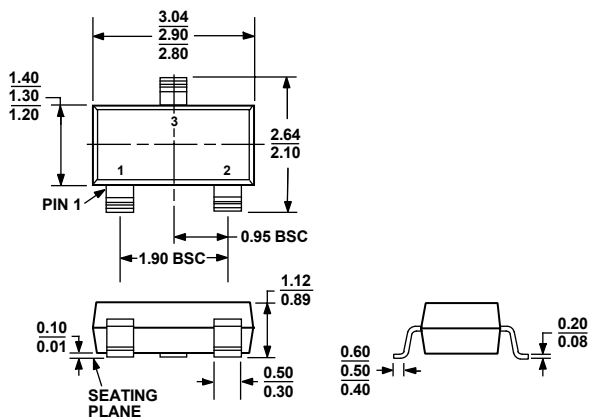

Figure 23. Micropower Buffered Reference

OUTLINE DIMENSIONS



COMPLIANT TO JEDEC STANDARDS TO-236-AB

Figure 26. 3-Lead Small Outline Transistor Package [SOT-23-3] (RT-3)

Dimensions shown in millimeters

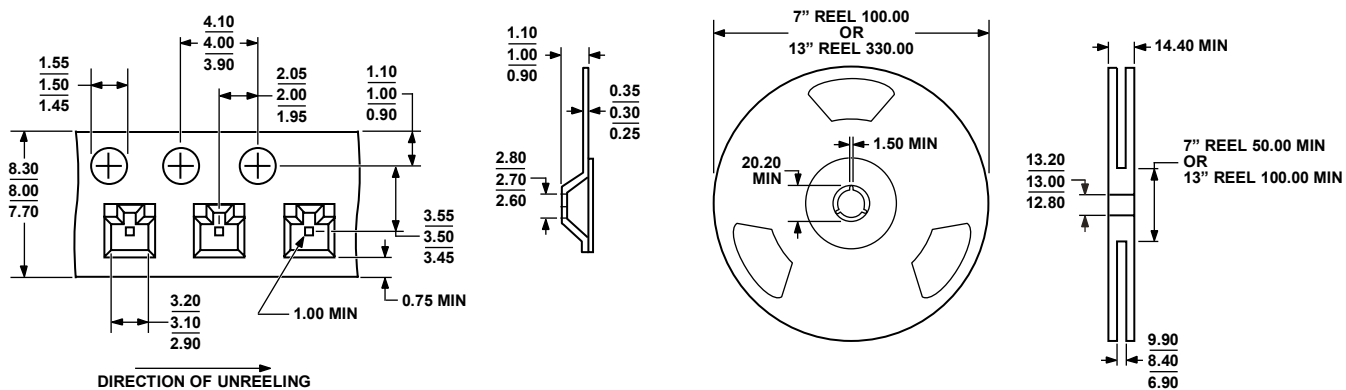

Figure 27. Tape and Reel Dimensions (RT-3)

Dimensions shown in millimeters

053006-0

ADR1581

ORDERING GUIDE

Model	Temperature Range	Initial Output Error	Temperature Coefficient	Package Description	Package Option	Branding
ADR1581ARTZ-REEL7 ¹	-40°C to +85°C	10 mV	100 ppm/°C	3-Lead SOT-23-3	RT-3	R2M
ADR1581ARTZ-R2 ¹	-40°C to +85°C	10 mV	100 ppm/°C	3-Lead SOT-23-3	RT-3	R2M
ADR1581BRTZ-REEL7 ¹	-40°C to +85°C	1 mV	50 ppm/°C	3-Lead SOT-23-3	RT-3	R2K
ADR1581BRTZ-R2 ¹	-40°C to +85°C	1 mV	50 ppm/°C	3-Lead SOT-23-3	RT-3	R2K

¹ Z = RoHS Compliant Part.

Looking for pricing, stock, or lifecycle information?

Click below to explore more details on WIN SOURCE:

 [View ADR1581BRTZ-R2 on WIN SOURCE](#)

 [Analog Devices Inc. Information](#)

Optimize Your Supply Chain with WIN SOURCE Solutions

-  Global Sourcing Solution
-  Obsolete Management
-  Cost Control Management
-  Shortage Management
-  Alternative Solution
-  Excess Inventory Management