

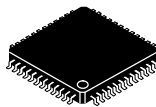

**THE DATASHEET OF  
ADS8406IBPFBT**





# 16-BIT, 1.25 MSPS, PSEUDO-BIPOLAR, FULLY DIFFERENTIAL INPUT, MICRO POWER SAMPLING ANALOG-TO-DIGITAL CONVERTER WITH PARALLEL INTERFACE

## FEATURES

- Pseudo-Bipolar, Fully Differential Input,  $-V_{REF}$  to  $V_{REF}$
- 16-Bit NMC at 1.25 MSPS
- $\pm 2$  LSB INL Max,  $-1/+1.25$  LSB DNL
- 90 dB SNR,  $-95$  dB THD at 100 kHz Input
- Zero Latency
- Internal 4.096 V Reference
- High-Speed Parallel Interface
- Single 5 V Analog Supply
- Wide I/O Supply: 2.7 V to 5.25 V
- Low Power: 155 mW at 1.25 MHz Typ
- Pin Compatible With ADS8412/8402
- 48-Pin TQFP Package

## APPLICATIONS

- DWDM
- Instrumentation
- High-Speed, High-Resolution, Zero Latency Data Acquisition Systems
- Transducer Interface
- Medical Instruments
- Communications

## DESCRIPTION

The ADS8406 is a 16-bit, 1.25 MHz A/D converter with an internal 4.096-V reference. The device includes a 16-bit capacitor-based SAR A/D converter with inherent sample and hold. The ADS8406 offers a full 16-bit interface and an 8-bit option where data is read using two 8-bit read cycles.

The ADS8406 has a pseudo-bipolar, fully differential input. It is available in a 48-lead TQFP package and is characterized over the industrial  $-40^{\circ}\text{C}$  to  $85^{\circ}\text{C}$  temperature range.

### High Speed SAR Converter Family

Type/Speed	500 kHz	580 kHz	750 MHz	1.25 MHz	2 MHz	3 MHz	4 MHz
18 Bit Pseudo-Diff	ADS8383	ADS8381					
16 Bit Pseudo-Diff			ADS8371	ADS8401	ADS8411		
				ADS8405			
16 Bit Pseudo Bipolar, Fully Differential				ADS8402	ADS8412		
				ADS8406			
14 Bit Pseudo-Diff				ADS7890 (S)		ADS7891	
12 Bit Pseudo-Diff							ADS7881

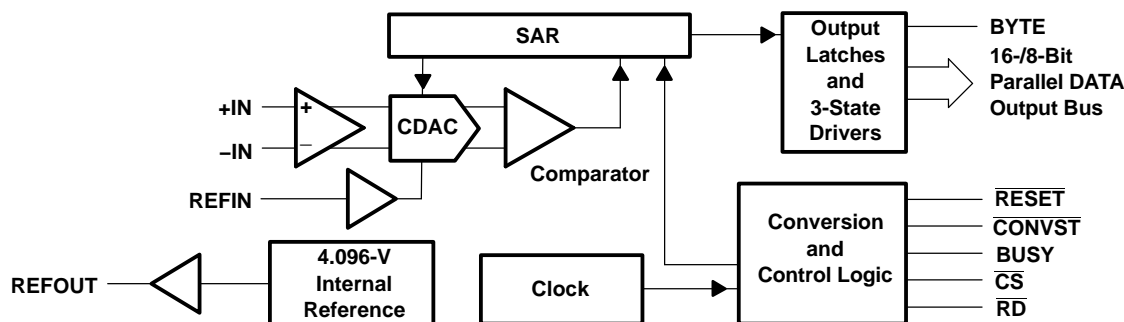

Please be aware that an important notice concerning availability, standard warranty, and use in critical applications of Texas Instruments semiconductor products and disclaimers thereto appears at the end of this data sheet.

**ORDERING INFORMATION<sup>(1)</sup>**

MODEL	MAXIMUM INTEGRAL LINEARITY (LSB)	MAXIMUM DIFFERENTIAL LINEARITY (LSB)	NO MISSING CODES RESOLUTION (BIT)	PACKAGE TYPE	PACKAGE DESIGNATOR	TEMPERATURE RANGE	ORDERING INFORMATION	TRANSPORT MEDIA QUANTITY
ADS8406I	-4 to +4	-2 to +2	15	48 Pin TQFP	PFB	-40°C to 85°C	ADS8406IPFBT	Tape and reel 250
							ADS8406IPFBR	Tape and reel 1000
ADS8406IB	-2 to +2	-1 to +1.25	16	48 Pin TQFP	PFB	-40°C to 85°C	ADS8406IBPFBT	Tape and reel 250
							ADS8406IBPFBR	Tape and reel 1000

(1) For the most current specifications and package information, refer to our website at [www.ti.com](http://www.ti.com).

**ABSOLUTE MAXIMUM RATINGS**

over operating free-air temperature range unless otherwise noted<sup>(1)</sup>

		UNIT
Voltage	+IN to AGND	-0.4 V to +VA + 0.1 V
	-IN to AGND	-0.4 V to +VA + 0.1 V
Voltage range	+VA to AGND	-0.3 V to 7 V
	+VBD to BDGND	-0.3 V to 7 V
	+VA to +VBD	-0.3 V to 2.55 V
Digital input voltage to BDGND		-0.3 V to +VBD + 0.3 V
Digital output voltage to BDGND		-0.3 V to +VBD + 0.3 V
T <sub>A</sub>	Operating free-air temperature range	-40°C to 85°C
T <sub>stg</sub>	Storage temperature range	-65°C to 150°C
Junction temperature (T <sub>J</sub> max)		150°C
TQFP package	Power dissipation	(T <sub>J</sub> Max - T <sub>A</sub> )/θ <sub>JA</sub>
	θ <sub>JA</sub> thermal impedance	86°C/W
Lead temperature, soldering	Vapor phase (60 sec)	215°C
	Infrared (15 sec)	220°C

(1) Stresses beyond those listed under *absolute maximum ratings* may cause permanent damage to the device. These are stress ratings only, and functional operation of the device at these or any other conditions beyond those indicated under *recommended operating conditions* is not implied. Exposure to absolute-maximum-rated conditions for extended periods may affect device reliability.

**SPECIFICATIONS**
 $T_A = -40^{\circ}\text{C}$  to  $85^{\circ}\text{C}$ ,  $+V_A = 5\text{ V}$ ,  $+V_{BD} = 3\text{ V}$  or  $5\text{ V}$ ,  $V_{\text{ref}} = 4.096\text{ V}$ ,  $f_{\text{SAMPLE}} = 1.25\text{ MHz}$  (unless otherwise noted)

PARAMETER		TEST CONDITIONS	MIN	TYP	MAX	UNIT
<b>ANALOG INPUT</b>						
Full-scale input voltage <sup>(1)</sup>		+IN – (–IN)	$-V_{\text{ref}}$		$V_{\text{ref}}$	V
Absolute input voltage		+IN	–0.2		$V_{\text{ref}} + 0.2$	V
		–IN	–0.2		$V_{\text{ref}} + 0.2$	
Input capacitance				25		pF
Input leakage current				0.5		nA
<b>SYSTEM PERFORMANCE</b>						
Resolution				16		Bits
No missing codes		ADS8406I		15		Bits
		ADS8406IB		16		
INL	Integral linearity <sup>(2)(3)</sup>	ADS8406I	–4	$\pm 2$	4	LSB
		ADS8406IB	–2	$\pm 1$	2	
DNL	Differential linearity	ADS8406I	–2	$\pm 1$	2	LSB
		ADS8406IB	–1	$\pm 0.5$	1.25	
$E_O$	Offset error <sup>(4)</sup>	ADS8406I	–2.5	$\pm 1$	2.5	mV
		ADS8406IB	–1.5	$\pm 0.5$	1.5	mV
$E_G$	Gain error <sup>(4)(5)</sup>	ADS8406I	–0.12		0.12	%FS
		ADS8406IB	–0.098		0.098	
CMRR	Common mode rejection ratio	At dc (0.2 V around $V_{\text{ref}}/2$ )		80		dB
		+IN – (–IN) = 1 $V_{\text{pp}}$ at 1 MHz		80		
PSRR	DC Power supply rejection ratio	At 7FFFh output code, $+V_A = 4.75\text{ V}$ to $5.25\text{ V}$ , $V_{\text{ref}} = 4.096\text{ V}$ <sup>(4)</sup>		2		LSB
<b>SAMPLING DYNAMICS</b>						
Conversion time			500		650	ns
Acquisition time			150			ns
Throughput rate					1.25	MHz
Aperture delay				2		ns
Aperture jitter				25		ps
Step response				100		ns
Overvoltage recovery				100		ns
<b>DYNAMIC CHARACTERISTICS</b>						
THD	Total harmonic distortion <sup>(6)</sup>	$V_{\text{IN}} = 8 V_{\text{pp}}$ at 100 kHz		–95		dB
		$V_{\text{IN}} = 8 V_{\text{pp}}$ at 500 kHz		–90		
SNR	Signal-to-noise ratio	$V_{\text{IN}} = 8 V_{\text{pp}}$ at 100 kHz		90		dB
SINAD	Signal-to-noise + distortion	$V_{\text{IN}} = 8 V_{\text{pp}}$ at 100 kHz		88		dB
SFDR	Spurious free dynamic range	$V_{\text{IN}} = 8 V_{\text{pp}}$ at 100 kHz		95		dB
		$V_{\text{IN}} = 8 V_{\text{pp}}$ at 500 kHz		93		
–3dB Small signal bandwidth				5		MHz
<b>EXTERNAL VOLTAGE REFERENCE INPUT</b>						
Reference voltage at REFIN, $V_{\text{ref}}$			2.5	4.096	4.2	V
Reference resistance <sup>(7)</sup>				500		k $\Omega$

(1) Ideal input span, does not include gain or offset error.

(2) LSB means least significant bit

(3) This is endpoint INL, not best fit.

(4) Measured relative to an ideal full-scale input [+IN – (–IN)] of 8.192 V

(5) This specification does not include the internal reference voltage error and drift.

(6) Calculated on the first nine harmonics of the input frequency

(7) Can vary  $\pm 20\%$

**SPECIFICATIONS (continued)**

$T_A = -40^{\circ}\text{C}$  to  $85^{\circ}\text{C}$ ,  $+VA = 5\text{ V}$ ,  $+VBD = 3\text{ V}$  or  $5\text{ V}$ ,  $V_{\text{ref}} = 4.096\text{ V}$ ,  $f_{\text{SAMPLE}} = 1.25\text{ MHz}$  (unless otherwise noted)

PARAMETER		TEST CONDITIONS	MIN	TYP	MAX	UNIT
<b>INTERNAL REFERENCE OUTPUT</b>						
	Internal reference start-up time	From 95% (+VA) with 1- $\mu\text{F}$ storage capacitor			120	ms
$V_{\text{ref}}$	Reference voltage	IOUT = 0	4.065	4.096	4.13	V
	Source current	Static load			10	$\mu\text{A}$
	Line regulation	+VA = 4.75 to 5.25 V		0.6		mV
	Drift	IOUT = 0		36		PPM/ $^{\circ}\text{C}$
<b>DIGITAL INPUT/OUTPUT</b>						
	Logic family — CMOS					
$V_{\text{IH}}$	High level input voltage	$I_{\text{IH}} = 5\ \mu\text{A}$	+VBD – 1		+VBD + 0.3	V
$V_{\text{IL}}$	Low level input voltage	$I_{\text{IL}} = 5\ \mu\text{A}$	–0.3		0.8	
$V_{\text{OH}}$	High level output voltage	$I_{\text{OH}} = 2\text{ TTL loads}$	+VBD – 0.6		+VBD	
$V_{\text{OL}}$	Low level output voltage	$I_{\text{OL}} = 2\text{ TTL loads}$	0		0.4	
	Data format — 2's complement					
<b>POWER SUPPLY REQUIREMENTS</b>						
Power supply voltage	+VBD		2.7	3	5.25	V
	+VA		4.75	5	5.25	V
	Supply current, +VA <sup>(8)</sup>	$f_s = 1.25\text{ MHz}$		31	34	mA
$P_D$	Power dissipation <sup>(8)</sup>	$f_s = 1.25\text{ MHz}$		155	170	mW
<b>TEMPERATURE RANGE</b>						
$T_A$	Operating free-air temperature		–40		85	$^{\circ}\text{C}$

(8) This includes only +VA current. +VBD current is typically 1 mA with 5-pF load capacitance on output pins.

## TIMING CHARACTERISTICS

All specifications typical at  $-40^{\circ}\text{C}$  to  $85^{\circ}\text{C}$ ,  $+V_A = +V_{BD} = 5\text{ V}$  <sup>(1)(2)(3)</sup>

PARAMETER		MIN	TYP	MAX	UNIT
$t_{\text{CONV}}$	Conversion time	500		650	ns
$t_{\text{ACQ}}$	Acquisition time	150			ns
$t_{\text{pd1}}$	$\overline{\text{CONVST}}$ low to BUSY high		40		ns
$t_{\text{pd2}}$	Propagation delay time, end of conversion to BUSY low		5		ns
$t_{\text{w1}}$	Pulse duration, $\overline{\text{CONVST}}$ low	20			ns
$t_{\text{su1}}$	Setup time, $\overline{\text{CS}}$ low to $\overline{\text{CONVST}}$ low	0			ns
$t_{\text{w2}}$	Pulse duration, $\overline{\text{CONVST}}$ high	20			ns
	$\overline{\text{CONVST}}$ falling edge jitter			10	ps
$t_{\text{w3}}$	Pulse duration, BUSY signal low	$\text{Min}(t_{\text{ACQ}})$			ns
$t_{\text{w4}}$	Pulse duration, BUSY signal high		610		ns
$t_{\text{h1}}$	Hold time, First data bus data transition ( $\overline{\text{RD}}$ low, or $\overline{\text{CS}}$ low for read cycle, or BYTE input changes) after $\overline{\text{CONVST}}$ low	40			ns
$t_{\text{d1}}$	Delay time, $\overline{\text{CS}}$ low to $\overline{\text{RD}}$ low (or BUSY low to $\overline{\text{RD}}$ low when $\overline{\text{CS}} = 0$ )	0			ns
$t_{\text{su2}}$	Setup time, $\overline{\text{RD}}$ high to $\overline{\text{CS}}$ high	0			ns
$t_{\text{w5}}$	Pulse duration, $\overline{\text{RD}}$ low time	50			ns
$t_{\text{en}}$	Enable time, $\overline{\text{RD}}$ low (or $\overline{\text{CS}}$ low for read cycle) to data valid			20	ns
$t_{\text{d2}}$	Delay time, data hold from $\overline{\text{RD}}$ high	0			ns
$t_{\text{d3}}$	Delay time, BYTE rising edge or falling edge to data valid	2		20	ns
$t_{\text{w6}}$	Pulse duration, $\overline{\text{RD}}$ high	20			ns
$t_{\text{w7}}$	Pulse duration, $\overline{\text{CS}}$ high time	20			ns
$t_{\text{h2}}$	Hold time, last $\overline{\text{RD}}$ (or $\overline{\text{CS}}$ for read cycle ) rising edge to $\overline{\text{CONVST}}$ falling edge	50			ns
$t_{\text{su3}}$	Setup time, BYTE transition to $\overline{\text{RD}}$ falling edge	0			ns
$t_{\text{h3}}$	Hold time, BYTE transition to $\overline{\text{RD}}$ falling edge	0			ns
$t_{\text{dis}}$	Disable time, $\overline{\text{RD}}$ high ( $\overline{\text{CS}}$ high for read cycle) to 3-stated data bus			20	ns
$t_{\text{d5}}$	Delay time, end of conversion to MSB data valid			10	ns
$t_{\text{su4}}$	Byte transition setup time, from BYTE transition to next BYTE transition	50			ns
$t_{\text{d6}}$	Delay time, $\overline{\text{CS}}$ rising edge to BUSY falling edge	50			ns
$t_{\text{d7}}$	Delay time, BUSY falling edge to $\overline{\text{CS}}$ rising edge	50			ns
$t_{\text{su(AB)}}$	Setup time, from the falling edge of $\overline{\text{CONVST}}$ (used to start the valid conversion) to the next falling edge of $\overline{\text{CONVST}}$ (when $\overline{\text{CS}} = 0$ and $\overline{\text{CONVST}}$ used to abort) or to the next falling edge of $\overline{\text{CS}}$ (when $\overline{\text{CS}}$ is used to abort)	60		500	ns
$t_{\text{su5}}$	Setup time, falling edge of $\overline{\text{CONVST}}$ to read valid data (MSB) from current conversion	$\text{MAX}(t_{\text{CONV}}) + \text{MAX}(t_{\text{d5}})$			ns
$t_{\text{h4}}$	Hold time, data (MSB) from previous conversion hold valid from falling edge of $\overline{\text{CONVST}}$		$\text{MIN}(t_{\text{CONV}})$		ns

(1) All input signals are specified with  $t_r = t_f = 5\text{ ns}$  (10% to 90% of  $+V_{BD}$ ) and timed from a voltage level of  $(V_{\text{IL}} + V_{\text{IH}})/2$ .

(2) See timing diagrams.

(3) All timings are measured with 20-pF equivalent loads on all data bits and BUSY pins.

### TIMING CHARACTERISTICS

All specifications typical at  $-40^{\circ}\text{C}$  to  $85^{\circ}\text{C}$ ,  $+V_A = 5\text{ V}$ ,  $+V_{BD} = 3\text{ V}$  <sup>(1)(2)(3)</sup>

PARAMETER		MIN	TYP	MAX	UNIT
$t_{\text{CONV}}$	Conversion time	500		650	ns
$t_{\text{ACQ}}$	Acquisition time	150			ns
$t_{\text{pd1}}$	$\overline{\text{CONVST}}$ low to BUSY high		50		ns
$t_{\text{pd2}}$	Propagation delay time, end of conversion to BUSY low		10		ns
$t_{\text{w1}}$	Pulse duration, $\overline{\text{CONVST}}$ low	20			ns
$t_{\text{su1}}$	Setup time, $\overline{\text{CS}}$ low to $\overline{\text{CONVST}}$ low	0			ns
$t_{\text{w2}}$	Pulse duration, $\overline{\text{CONVST}}$ high	20			ns
	$\overline{\text{CONVST}}$ falling edge jitter			10	ps
$t_{\text{w3}}$	Pulse duration, BUSY signal low	Min( $t_{\text{ACQ}}$ )			ns
$t_{\text{w4}}$	Pulse duration, BUSY signal high		610		ns
$t_{\text{h1}}$	Hold time, first data bus transition ( $\overline{\text{RD}}$ low, or $\overline{\text{CS}}$ low for read cycle, or BYTE or BUS 16/16 input changes) after $\overline{\text{CONVST}}$ low	40			ns
$t_{\text{d1}}$	Delay time, $\overline{\text{CS}}$ low to $\overline{\text{RD}}$ low (or BUSY low to $\overline{\text{RD}}$ low when $\overline{\text{CS}} = 0$ )	0			ns
$t_{\text{su2}}$	Setup time, $\overline{\text{RD}}$ high to $\overline{\text{CS}}$ high	0			ns
$t_{\text{w5}}$	Pulse duration, $\overline{\text{RD}}$ low	50			ns
$t_{\text{en}}$	Enable time, $\overline{\text{RD}}$ low (or $\overline{\text{CS}}$ low for read cycle) to data valid			30	ns
$t_{\text{d2}}$	Delay time, data hold from $\overline{\text{RD}}$ high	0			ns
$t_{\text{d3}}$	Delay time, BYTE rising edge or falling edge to data valid	2		30	ns
$t_{\text{w6}}$	Pulse duration, $\overline{\text{RD}}$ high time	20			ns
$t_{\text{w7}}$	Pulse duration, $\overline{\text{CS}}$ high time	20			ns
$t_{\text{h2}}$	Hold time, last $\overline{\text{RD}}$ (or $\overline{\text{CS}}$ for read cycle) rising edge to $\overline{\text{CONVST}}$ falling edge	50			ns
$t_{\text{su3}}$	Setup time, BYTE transition to $\overline{\text{RD}}$ falling edge	0			ns
$t_{\text{h3}}$	Hold time, BYTE transition to $\overline{\text{RD}}$ falling edge	0			ns
$t_{\text{dis}}$	Disable time, $\overline{\text{RD}}$ high ( $\overline{\text{CS}}$ high for read cycle) to 3-stated data bus			30	ns
$t_{\text{d5}}$	Delay time, end of conversion to MSB data valid			20	ns
$t_{\text{su4}}$	Byte transition setup time, from BYTE transition to next BYTE transition	50			ns
$t_{\text{d6}}$	Delay time, $\overline{\text{CS}}$ rising edge to BUSY falling edge	50			ns
$t_{\text{d7}}$	Delay time, BUSY falling edge to $\overline{\text{CS}}$ rising edge	50			ns
$t_{\text{su(AB)}}$	Setup time, from the falling edge of $\overline{\text{CONVST}}$ (used to start the valid conversion) to the next falling edge of $\overline{\text{CONVST}}$ (when $\overline{\text{CS}} = 0$ and $\overline{\text{CONVST}}$ used to abort) or to the next falling edge of $\overline{\text{CS}}$ (when $\overline{\text{CS}}$ is used to abort)	70		500	ns
$t_{\text{su5}}$	Setup time, falling edge of $\overline{\text{CONVST}}$ to read valid data (MSB) from current conversion	MAX( $t_{\text{CONV}}$ ) + MAX( $t_{\text{d5}}$ )			ns
$t_{\text{h4}}$	Hold time, data (MSB) from previous conversion hold valid from falling edge of $\overline{\text{CONVST}}$		MIN( $t_{\text{CONV}}$ )		ns

- (1) All input signals are specified with  $t_r = t_f = 5\text{ ns}$  (10% to 90% of  $+V_{BD}$ ) and timed from a voltage level of  $(V_{IL} + V_{IH})/2$ .
- (2) See timing diagrams.
- (3) All timings are measured with 20-pF equivalent loads on all data bits and BUSY pins.

**PIN ASSIGNMENTS**

**PFB PACKAGE  
(TOP VIEW)**

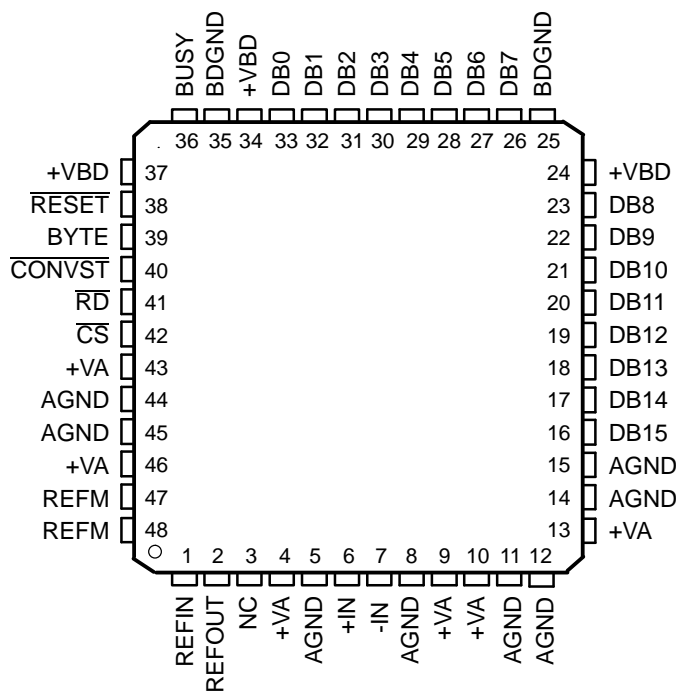

NC - No connection

**Terminal Functions**

NAME	NO.	I/O	DESCRIPTION		
AGND	5, 8, 11, 12, 14, 15, 44, 45	–	Analog ground		
BDGND	25, 35	–	Digital ground for bus interface digital supply		
BUSY	36	O	Status output. High when a conversion is in progress.		
BYTE	39	I	Byte select input. Used for 8-bit bus reading. 0: No fold back 1: Low byte D[7:0] of the 16 most significant bits is folded back to high byte of the 16 most significant pins DB[15:8].		
$\overline{\text{CONVST}}$	40	I	Convert start. The falling edge of this input ends the acquisition period and starts the hold period.		
$\overline{\text{CS}}$	42	I	Chip select. The falling edge of this input starts the acquisition period.		
Data Bus			<b>8-Bit Bus</b>		<b>16-Bit Bus</b>
			<b>BYTE = 0</b>	<b>BYTE = 1</b>	<b>BYTE = 0</b>
DB15	16	O	D15 (MSB)	D7	D15 (MSB)
DB14	17	O	D14	D6	D14
DB13	18	O	D13	D5	D13
DB12	19	O	D12	D4	D12
DB11	20	O	D11	D3	D11
DB10	21	O	D10	D2	D10
DB9	22	O	D9	D1	D9
DB8	23	O	D8	D0 (LSB)	D8
DB7	26	O	D7	All ones	D7
DB6	27	O	D6	All ones	D6
DB5	28	O	D5	All ones	D5
DB4	29	O	D4	All ones	D4
DB3	30	O	D3	All ones	D3
DB2	31	O	D2	All ones	D2
DB1	32	O	D1	All ones	D1
DB0	33	O	D0 (LSB)	All ones	D0 (LSB)
–IN	7	I	Inverting input channel		
+IN	6	I	Non inverting input channel		
NC	3	–	No connection		
REFIN	1	I	Reference input		
REFM	47, 48	I	Reference ground		
REFOUT	2	O	Reference output. Add 1- $\mu$ F capacitor between the REFOUT pin and REFM pin when internal reference is used.		
$\overline{\text{RESET}}$	38	I	Current conversion is aborted and output latches are cleared (set to zeros) when this pin is asserted low. $\overline{\text{RESET}}$ works independantly of $\overline{\text{CS}}$ .		
$\overline{\text{RD}}$	41	I	Synchronization pulse for the parallel output. When $\overline{\text{CS}}$ is low, this serves as the output enable and puts the previous conversion result on the bus.		
+VA	4, 9, 10, 13, 43, 46	–	Analog power supplies, 5-V dc		
+VBD	24, 34, 37	–	Digital power supply for bus		

TIMING DIAGRAMS

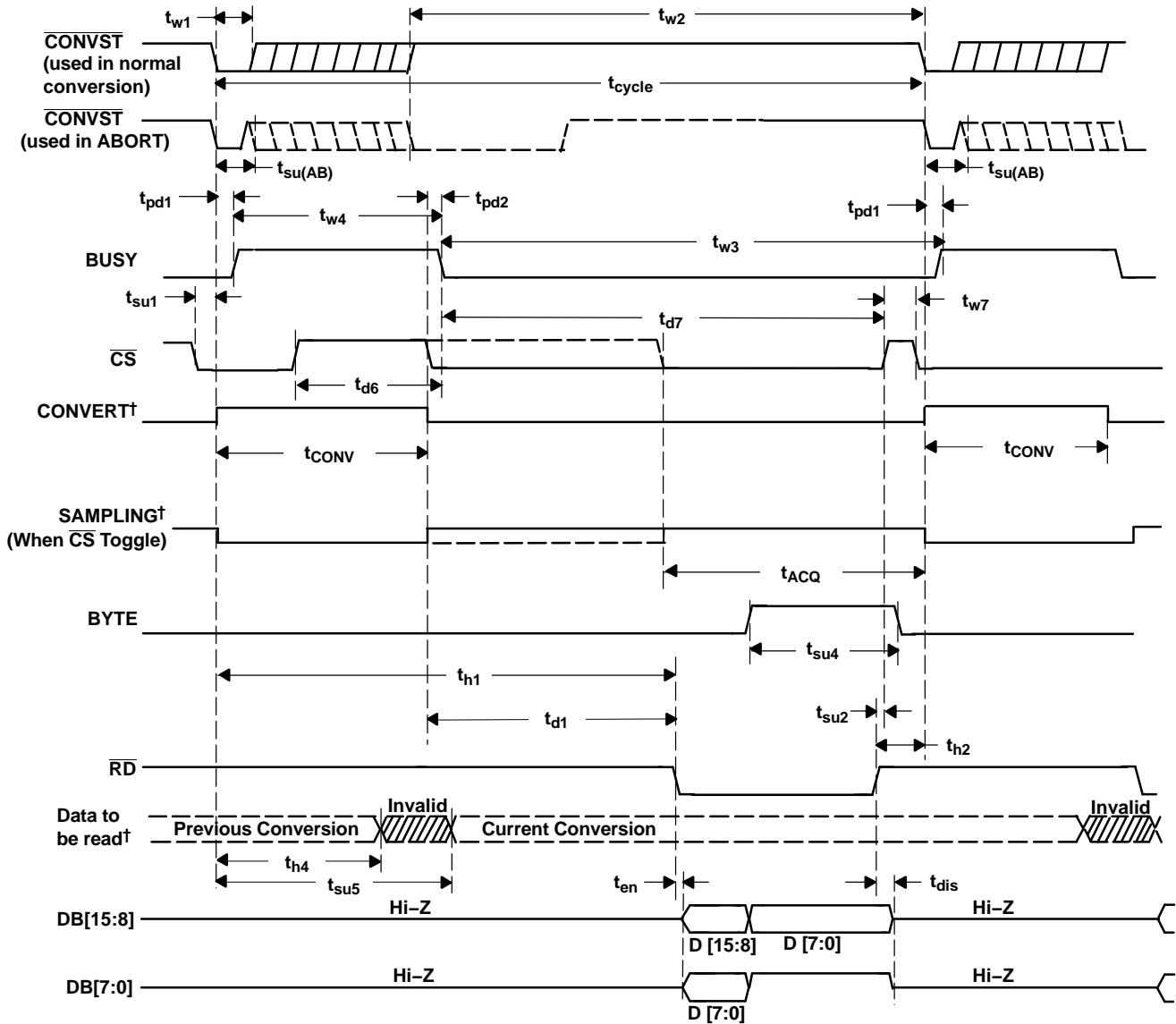

†Signal internal to device

Figure 1. Timing for Conversion and Acquisition Cycles With  $\overline{\text{CS}}$  and  $\overline{\text{RD}}$  Toggling

TIMING DIAGRAMS (continued)

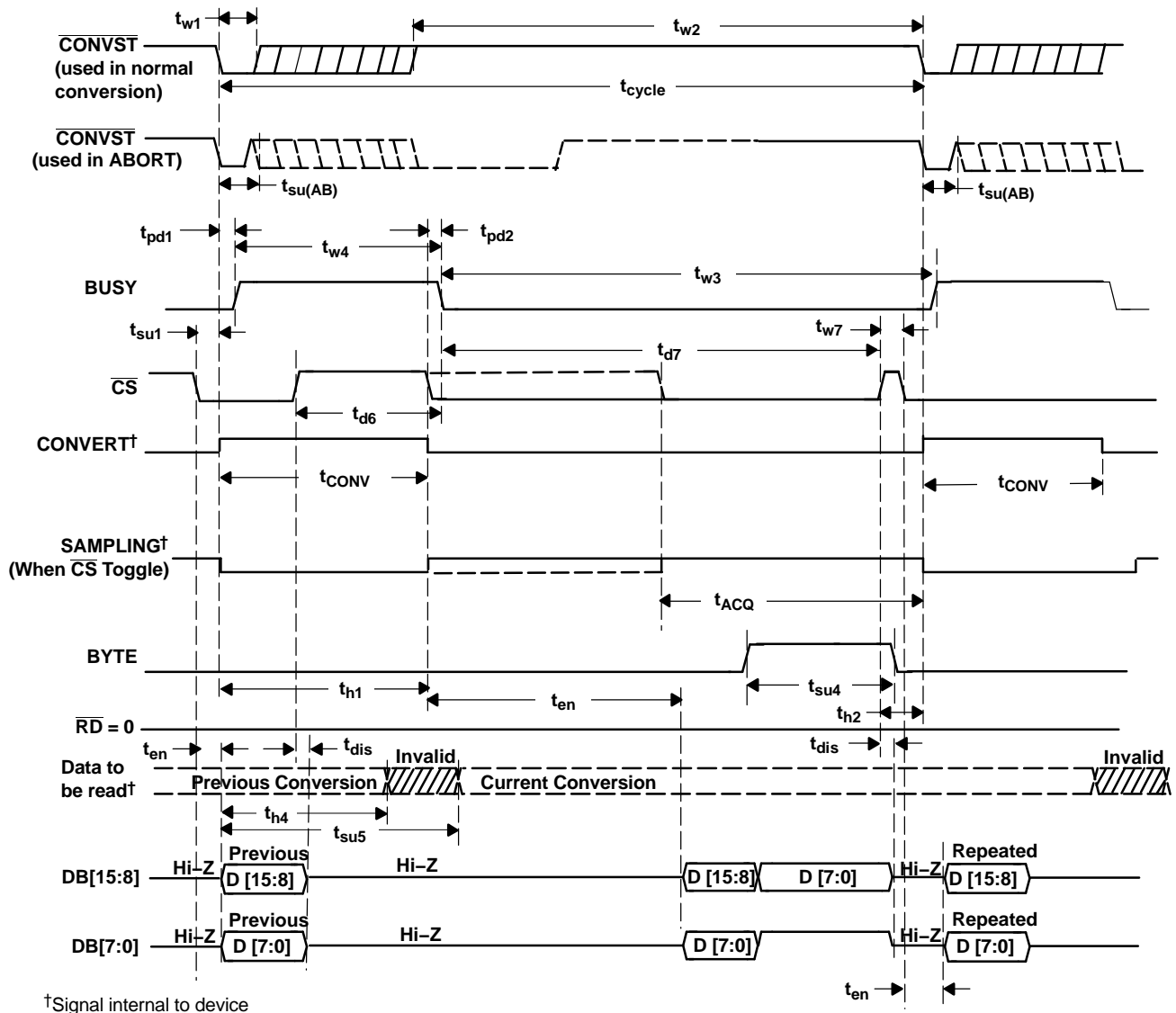
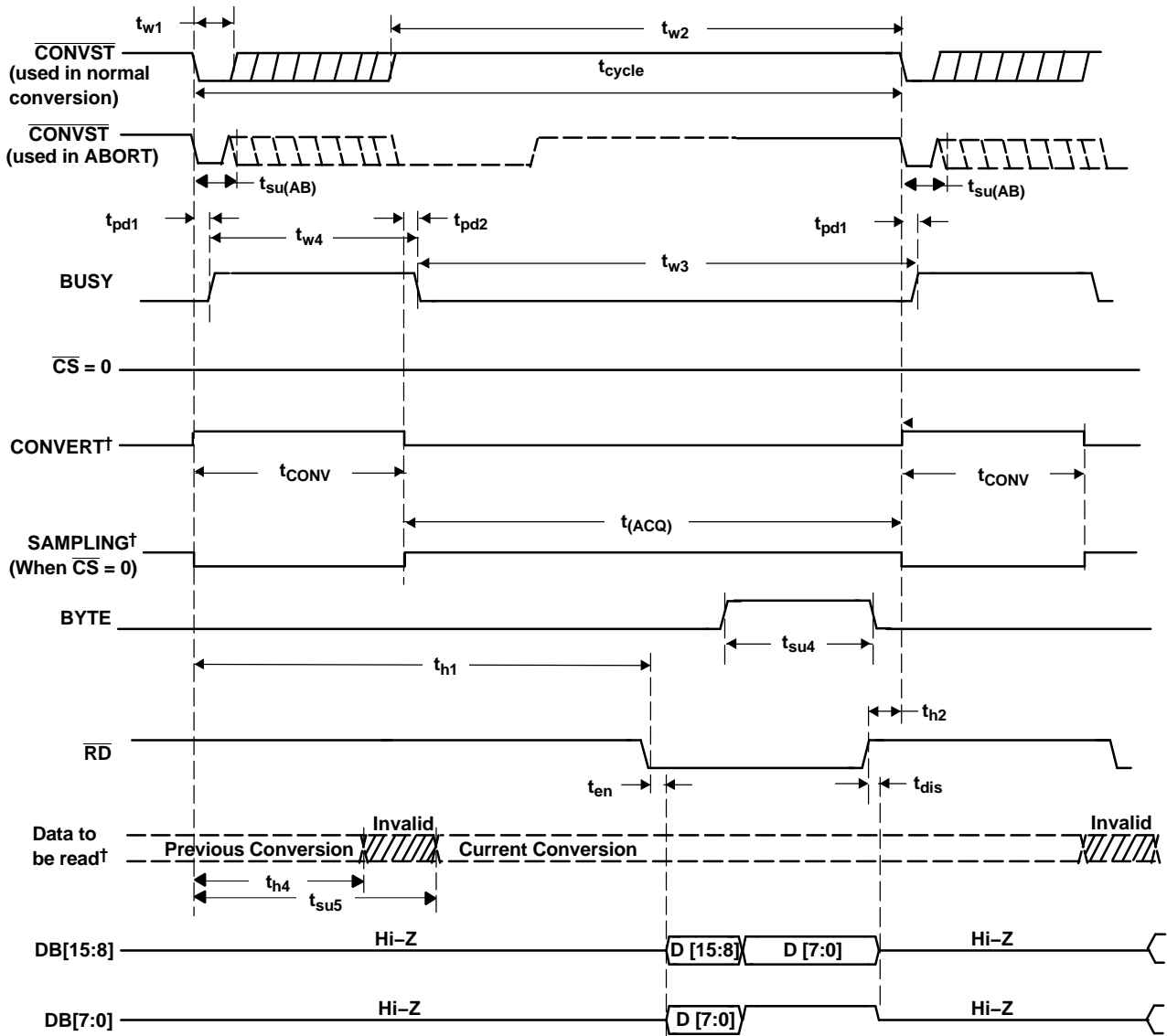

Figure 2. Timing for Conversion and Acquisition Cycles With  $\overline{CS}$  Toggling,  $\overline{RD}$  Tied to BDGND

**TIMING DIAGRAMS (continued)**



†Signal internal to device

**Figure 3. Timing for Conversion and Acquisition Cycles With  $\overline{CS}$  Tied to BDGND,  $\overline{RD}$  Toggling**

TIMING DIAGRAMS (continued)

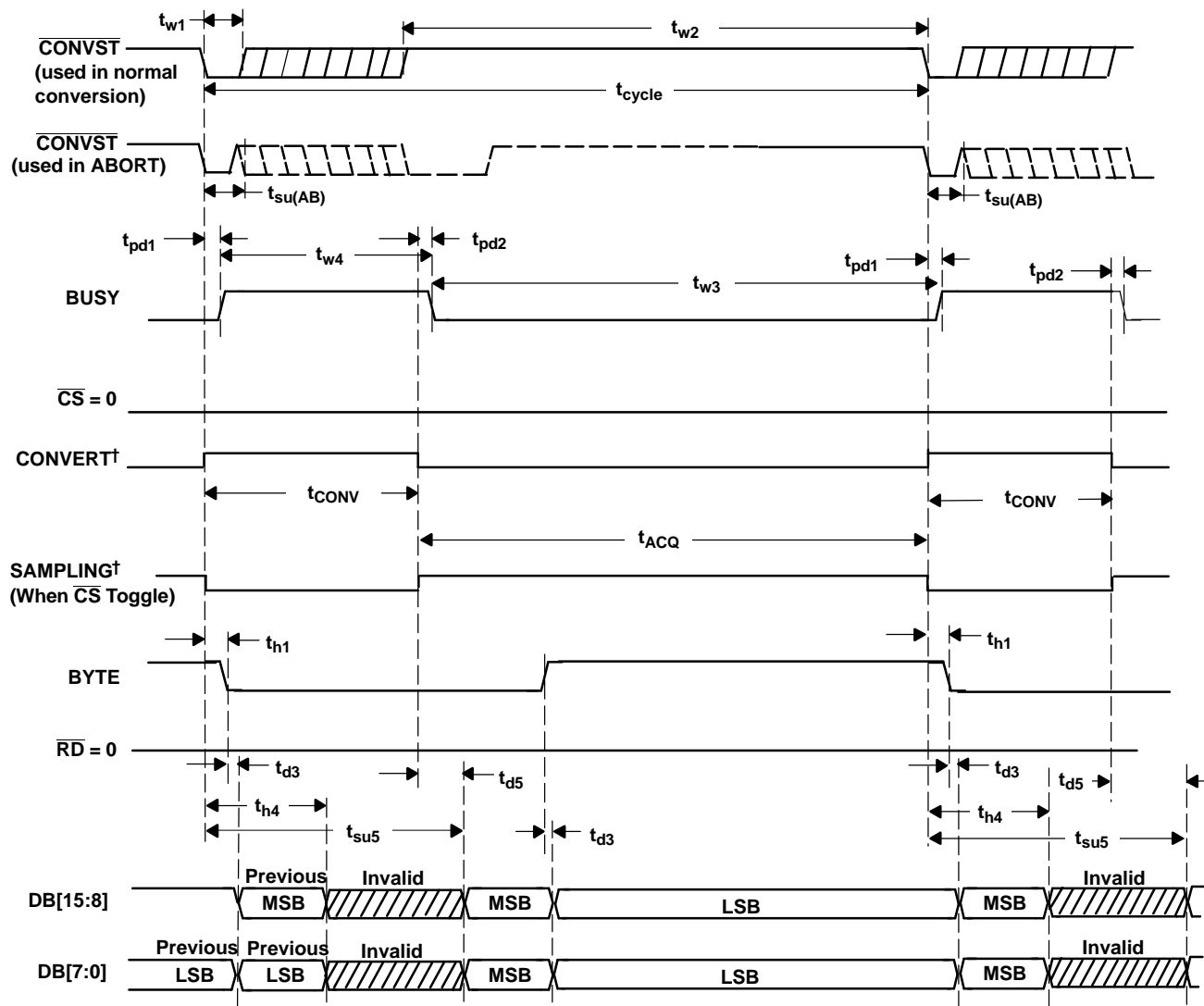

†Signal internal to device

Figure 4. Timing for Conversion and Acquisition Cycles With  $\overline{CS}$  and  $\overline{RD}$  Tied to BDGND—Auto Read

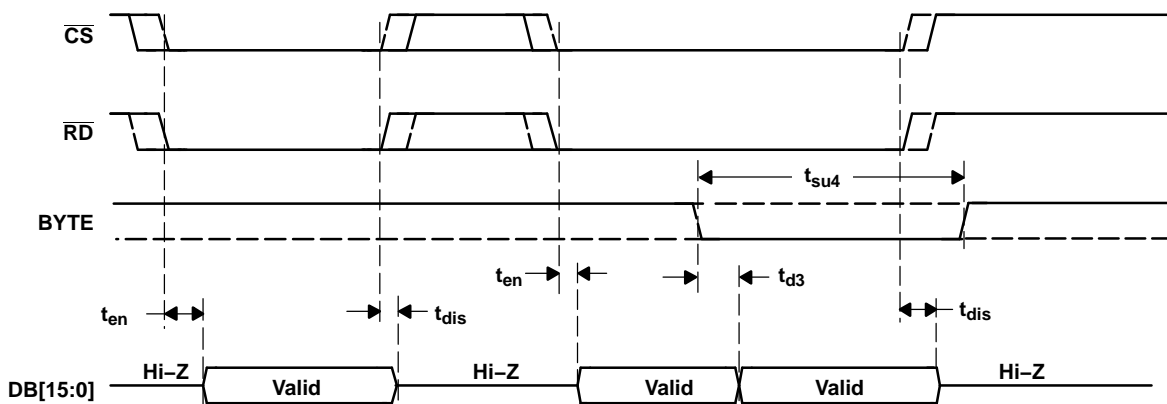

Figure 5. Detailed Timing for Read Cycles

## TYPICAL CHARACTERISTICS

At  $-40^{\circ}\text{C}$  to  $85^{\circ}\text{C}$ ,  $+V_A = 5\text{ V}$ ,  $+V_{BD} = 5\text{ V}$ ,  $\text{REFIN} = 4.096\text{ V}$  (internal reference used) and  $f_{\text{sample}} = 1.25\text{ MHz}$  (unless otherwise noted)

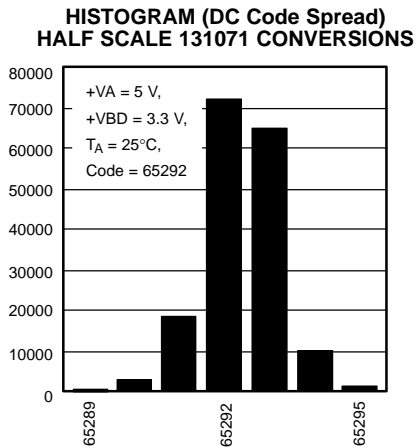

Figure 6.

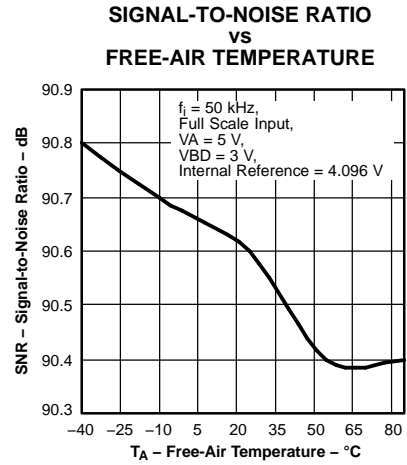

Figure 7.

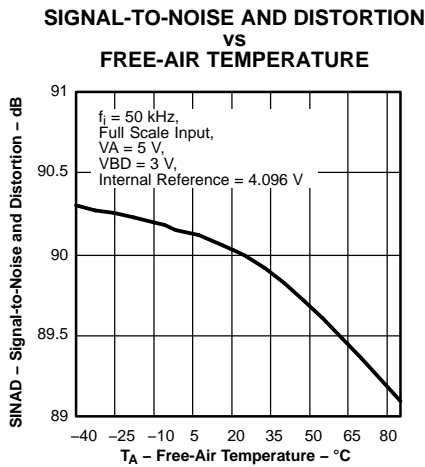

Figure 8.

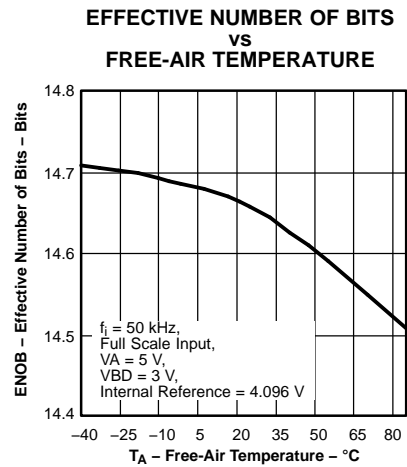

Figure 9.

TYPICAL CHARACTERISTICS (continued)

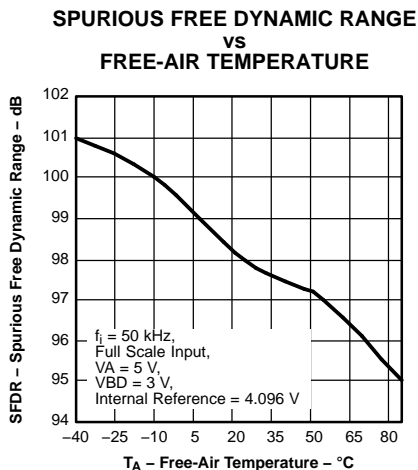

Figure 10.

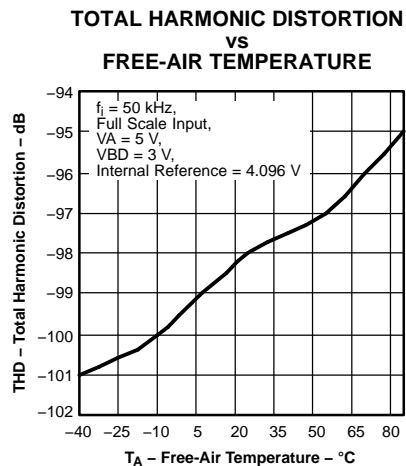

Figure 11.

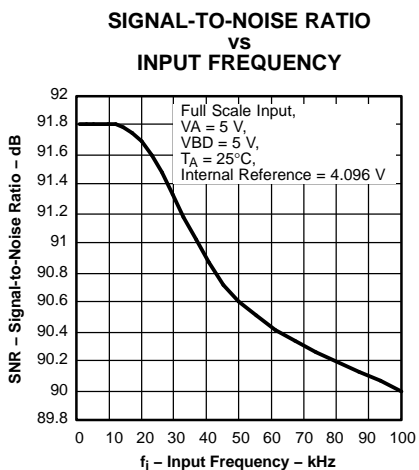

Figure 12.

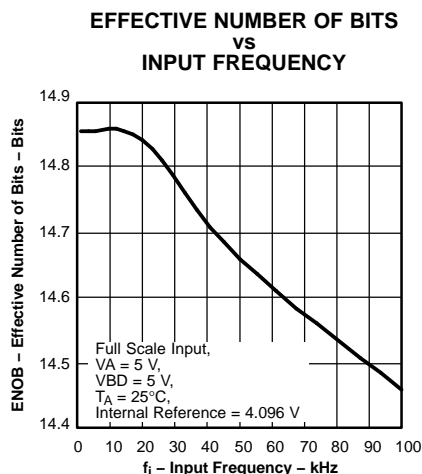

Figure 13.

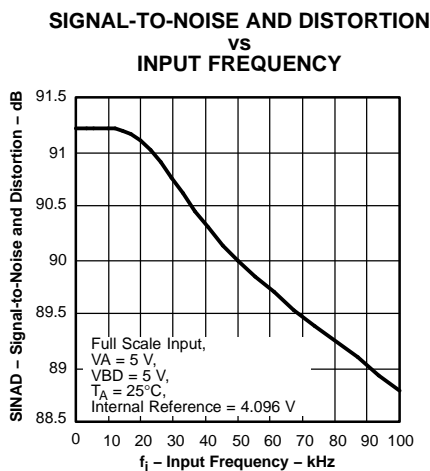

Figure 14.

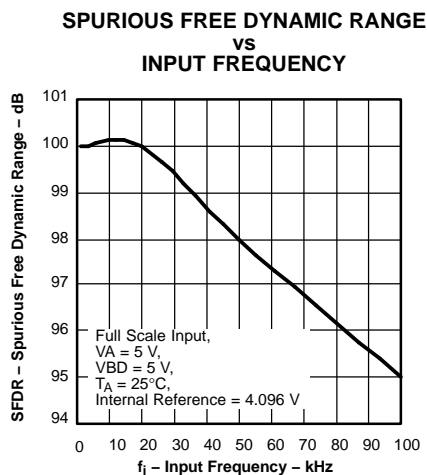

Figure 15.

TYPICAL CHARACTERISTICS (continued)

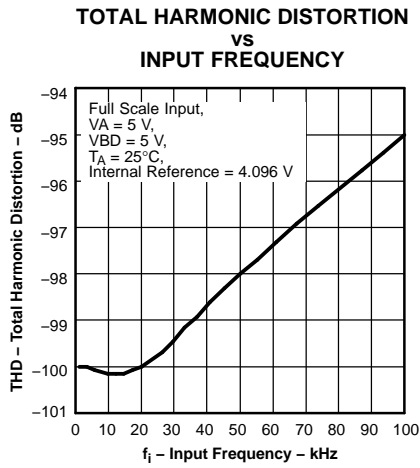

Figure 16.

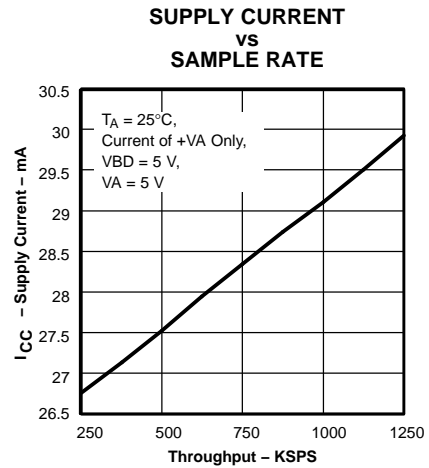

Figure 17.

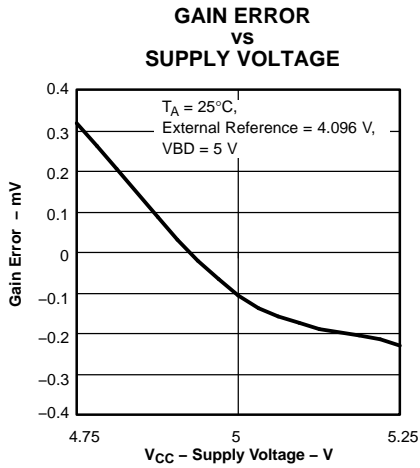

Figure 18.

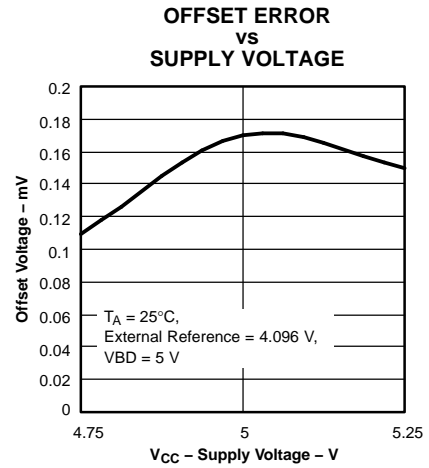

Figure 19.

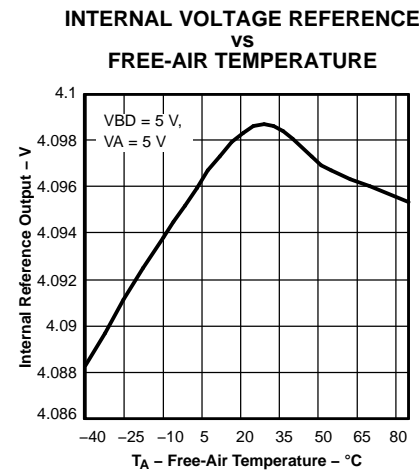

Figure 20.

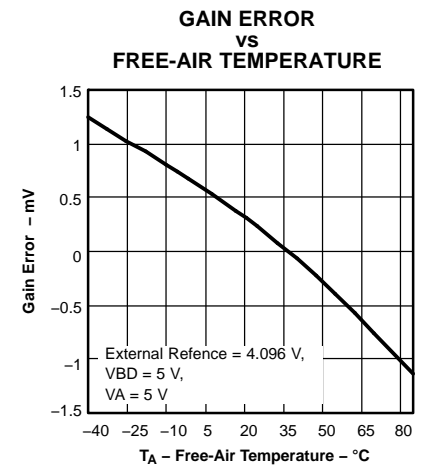

Figure 21.

TYPICAL CHARACTERISTICS (continued)

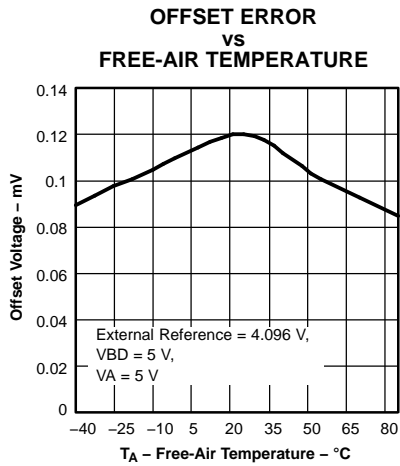

Figure 22.

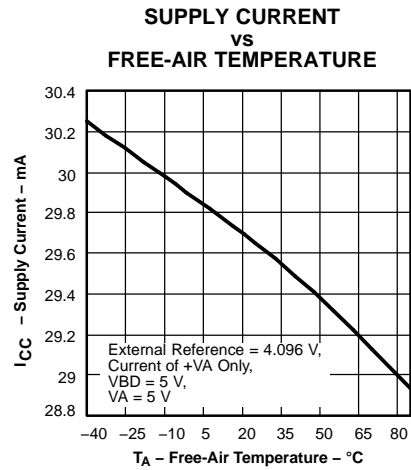

Figure 23.

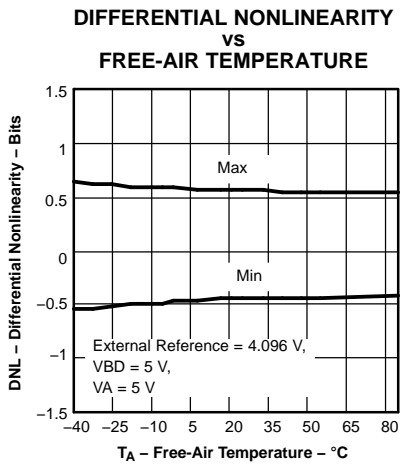

Figure 24.

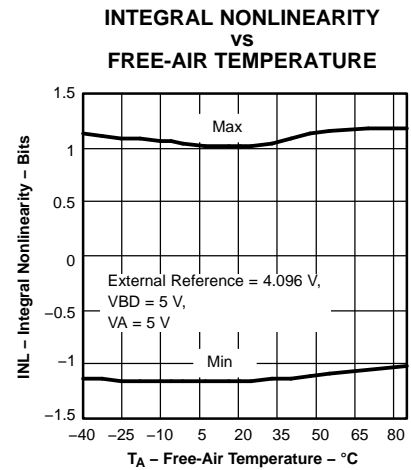

Figure 25.

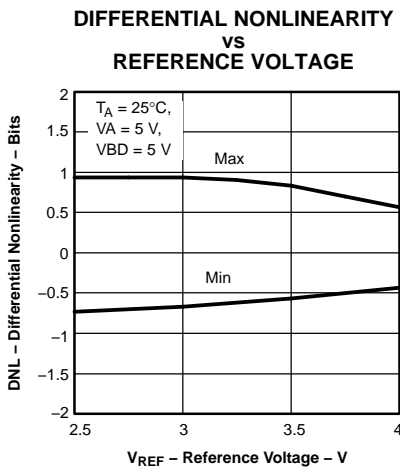

Figure 26.

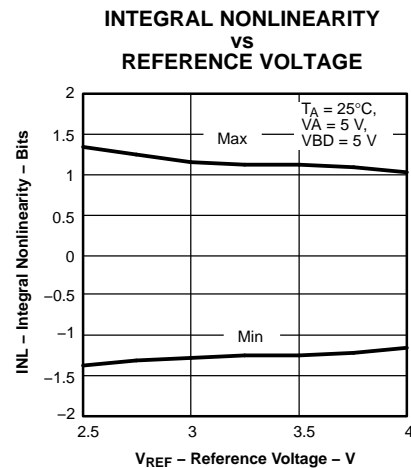
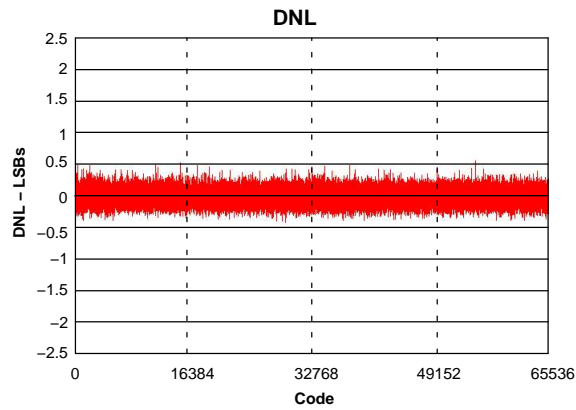
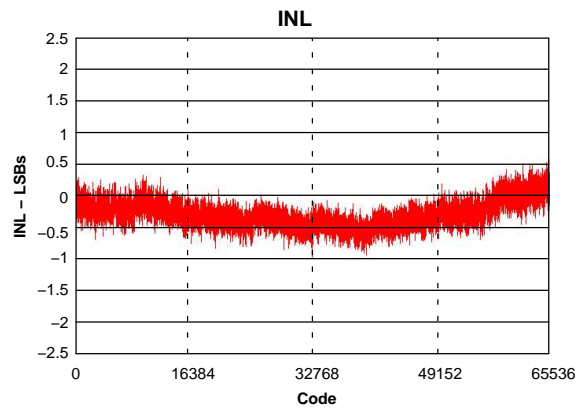

Figure 27.

**TYPICAL CHARACTERISTICS (continued)**



**Figure 28.**



**Figure 29.**

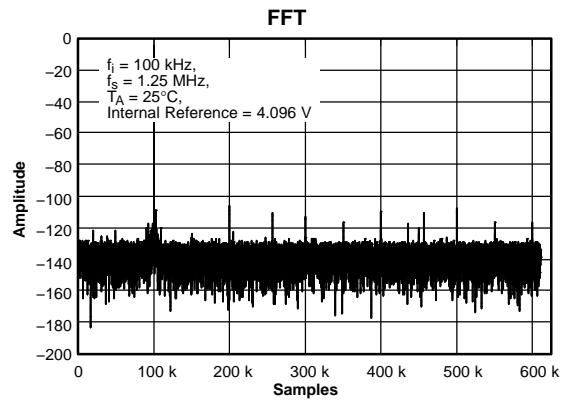

**Figure 30.**



## PRINCIPLES OF OPERATION (continued)

The analog input is provided to two input pins: +IN and –IN. When a conversion is initiated, the differential input on these pins is sampled on the internal capacitor array. While a conversion is in progress, both inputs are disconnected from any internal function.

## REFERENCE

The ADS8406 can operate with an external reference with a range from 2.5 V to 4.2 V. A 4.096-V internal reference is included. When internal reference is used, pin 2 (REFOUT) should be connected to pin 1 (REFIN) with a 0.1- $\mu$ F decoupling capacitor and 1- $\mu$ F storage capacitor between pin 2 (REFOUT) and pins 47 and 48 (REFM) (see Figure 33). The internal reference of the converter is double buffered. If an external reference is used, the second buffer provides isolation between the external reference and the CDAC. This buffer is also used to recharge all of the capacitors of the CDAC during conversion. Pin 2 (REFOUT) can be left unconnected (floating) if external reference is used.

## ANALOG INPUT

When the converter enters the hold mode, the voltage difference between the +IN and -IN inputs is captured on the internal capacitor array. Both +IN and –IN inputs have a range of  $-0.2$  V to  $V_{ref} + 0.2$  V. The input span (+IN – (–IN)) is limited to  $-V_{ref}$  to  $V_{ref}$ .

The input current on the analog inputs depends upon a number of factors: sample rate, input voltage, and source impedance. Essentially, the current into the ADS8406 charges the internal capacitor array during the sample period. After this capacitance has been fully charged, there is no further input current. The source of the analog input voltage must be able to charge the input capacitance (25 pF) to an 16-bit settling level within the acquisition time (150 ns) of the device. When the converter goes into the hold mode, the input impedance is greater than 1 G $\Omega$ .

Care must be taken regarding the absolute analog input voltage. To maintain the linearity of the converter, the +IN and –IN inputs and the span (+IN – (–IN)) should be within the limits specified. Outside of these ranges, the converter's linearity may not meet specifications. To minimize noise, low bandwidth input signals with low-pass filters should be used.

Care should be taken to ensure that the output impedance of the sources driving +IN and –IN inputs are matched. If this is not observed, the two inputs could have different settling time. This may result in offset error, gain error and linearity error which varies with temperature and input voltage.

A typical input circuit using TI's THS4503 is shown in Figure 33. Input from a single-ended source may be converted into a differential signal for the ADS8406 as shown in the figure. In case the source itself is differential, then the THS4503 may be used in differential input and differential output modes.

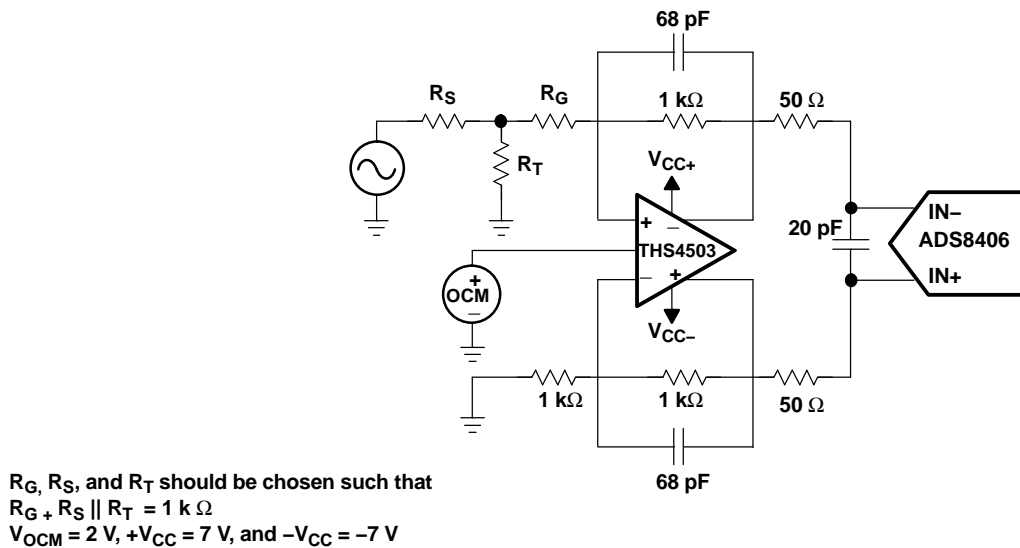

Figure 33. Using the THS4503 With the ADS8406

**PRINCIPLES OF OPERATION (continued)**

**DIGITAL INTERFACE**

**Timing And Control**

See the timing diagrams in the specifications section for detailed information on timing signals and their requirements.

The ADS8406 uses an internal oscillator generated clock which controls the conversion rate and in turn the throughput of the converter. No external clock input is required.

Conversions are initiated by bringing the  $\overline{\text{CONVST}}$  pin low for a minimum of 20 ns (after the 20 ns minimum requirement has been met, the  $\overline{\text{CONVST}}$  pin can be brought high), while  $\overline{\text{CS}}$  is low. The ADS8406 switches from the sample to the hold mode on the falling edge of the  $\overline{\text{CONVST}}$  command. A clean and low jitter falling edge of this signal is important to the performance of the converter. The BUSY output is brought high after  $\overline{\text{CONVST}}$  goes low. BUSY stays high throughout the conversion process and returns low when the conversion has ended.

Sampling starts as soon as the conversion is over when  $\overline{\text{CS}}$  is tied low or starts with the falling edge of  $\overline{\text{CS}}$  when BUSY is low.

Both  $\overline{\text{RD}}$  and  $\overline{\text{CS}}$  can be high during and before a conversion with one exception ( $\overline{\text{CS}}$  must be low when  $\overline{\text{CONVST}}$  goes low to initiate a conversion). Both the  $\overline{\text{RD}}$  and  $\overline{\text{CS}}$  pins are brought low in order to enable the parallel output bus with the conversion.

**Reading Data**

The ADS8406 outputs full parallel data in two's complement format as shown in Table 1. The parallel output is active when  $\overline{\text{CS}}$  and  $\overline{\text{RD}}$  are both low. There is a minimal quiet zone requirement around the falling edge of  $\overline{\text{CONVST}}$ . This is 50 ns prior to the falling edge of  $\overline{\text{CONVST}}$  and 40 ns after the falling edge. No data read should be attempted within this zone. Any other combination of  $\overline{\text{CS}}$  and  $\overline{\text{RD}}$  sets the parallel output to 3-state. BYTE is used for multiword read operations. BYTE is used whenever lower bits of the converter result are output on the higher byte of the bus. Refer to Table 1 for ideal output codes.

**Table 1. Ideal Input Voltages and Output Codes**

DESCRIPTION	ANALOG VALUE	DIGITAL OUTPUT	
		2'S COMPLEMENT	
Full scale range	$2(+V_{\text{ref}})$	BINARY CODE	HEX CODE
Least significant bit (LSB)	$2(+V_{\text{ref}})/65536$		
+Full scale	$(+V_{\text{ref}}) - 1 \text{ LSB}$	0111 1111 1111 1111	7FFF
Midscale	0 V	0000 0000 0000 0000	0000
Midscale - 1 LSB	$0 \text{ V} - 1 \text{ LSB}$	1111 1111 1111 1111	FFFF
- Full scale	$(-V_{\text{ref}})$	1000 0000 0000 0000	8000

The output data is a full 16-bit word (D15–D0) on DB15–DB0 pins (MSB–LSB) if BYTE is low.

The result may also be read on an 8-bit bus for convenience. This is done by using only pins DB15–DB8. In this case two reads are necessary: the first as before, leaving BYTE low and reading the 8 most significant bits on pins DB15–DB8, then bringing BYTE high. When BYTE is high, the low bits (D7–D0) appear on pins DB15–D8.

These multiword read operations can be done with multiple active  $\overline{\text{RD}}$  (toggling) or with  $\overline{\text{RD}}$  tied low for simplicity.

**Conversion Data Readout**

BYTE	DATA READ OUT	
	DB15–DB8 Pins	DB7–DB0 Pins
High	D7–D0	All one's
Low	D15–D8	D7–D0

## RESET

$\overline{\text{RESET}}$  is an asynchronous active low input signal (that works independently of  $\overline{\text{CS}}$ ). Minimum  $\overline{\text{RESET}}$  low time is 25 ns. Current conversion will be aborted no later than 50 ns after the converter is in the reset mode. In addition, all output latches are cleared (set to zero's) after  $\overline{\text{RESET}}$ . The converter goes back to normal operation mode no later than 20 ns after  $\overline{\text{RESET}}$  input is brought high.

The converter starts the first sampling period 20 ns after the rising edge of  $\overline{\text{RESET}}$ . Any sampling period except for the one immediately after a  $\overline{\text{RESET}}$  is started with the falling edge of the previous BUSY signal or the falling edge of CS, whichever is later.

Another way to reset the device is through the use of the combination of  $\overline{\text{CS}}$  and  $\overline{\text{CONVST}}$ . This is useful when the dedicated  $\overline{\text{RESET}}$  pin is tied to the system reset but there is a need to abort only the conversion in a specific converter. Since the BUSY signal is held high during the conversion, either one of these conditions triggers an internal self-clear reset to the converter just the same as a reset via the dedicated  $\overline{\text{RESET}}$  pin. The reset does not have to be cleared as for the dedicated  $\overline{\text{RESET}}$  pin. A reset can be started with either of the two following steps.

- Issue a  $\overline{\text{CONVST}}$  when  $\overline{\text{CS}}$  is low and a conversion is in progress. The falling edge of  $\overline{\text{CONVST}}$  must satisfy the timing as specified by the timing parameter  $t_{\text{su(AB)}}$  mentioned in the timing characteristics table to ensure a reset. The falling edge of  $\overline{\text{CONVST}}$  starts a reset. Timing is the same as a reset using the dedicated  $\overline{\text{RESET}}$  pin except the instance of the falling edge is replaced by the falling edge of  $\overline{\text{CONVST}}$ .
- Issue a  $\overline{\text{CS}}$  while a conversion is in progress. The falling edge of  $\overline{\text{CS}}$  must satisfy the timing as specified by the timing parameter  $t_{\text{su(AB)}}$  mentioned in the timing characteristics table to ensure a reset. The falling edge of  $\overline{\text{CS}}$  causes a reset. Timing is the same as a reset using the dedicated  $\overline{\text{RESET}}$  pin except the instance of the falling edge is replaced by the falling edge of  $\overline{\text{CS}}$ .

## POWER-ON INITIALIZATION

RESET is not required after power on. An internal power-on-reset circuit generates the reset. To ensure that all of the registers are cleared, the three conversion cycles must be given to the converter after power on.

## LAYOUT

For optimum performance, care should be taken with the physical layout of the ADS8406 circuitry.

As the ADS8406 offers single-supply operation, it is often used in close proximity with digital logic, microcontrollers, microprocessors, and digital signal processors. The more digital logic present in the design and the higher the switching speed, the more difficult it is to achieve good performance from the converter.

The basic SAR architecture is sensitive to glitches or sudden changes on the power supply, reference, ground connections and digital inputs that occur just prior to latching the output of the analog comparator. Thus, driving any single conversion for an n-bit SAR converter, there are at least n *windows* in which large external transient voltages can affect the conversion result. Such glitches might originate from switching power supplies, nearby digital logic, or high power devices.

The degree of error in the digital output depends on the reference voltage, layout, and the exact timing of the external event.

On average, the ADS8406 draws very little current from an external reference, as the reference voltage is internally buffered. If the reference voltage is external and originates from an op amp, make sure that it can drive the bypass capacitor or capacitors without oscillation. A 0.1- $\mu\text{F}$  bypass capacitor and a 1- $\mu\text{F}$  storage capacitor are recommended from pin 1 (REFIN) directly to pin 48 (REFM). REFM and AGND should be shorted on the same ground plane under the device.

The AGND and BDGND pins should be connected to a clean ground point. In all cases, this should be the analog ground. Avoid connections which are close to the grounding point of a microcontroller or digital signal processor. If required, run a ground trace directly from the converter to the power supply entry point. The ideal layout consists of an analog ground plane dedicated to the converter and associated analog circuitry.

As with the AGND connections, +VA should be connected to a 5-V power supply plane or trace that is separate from the connection for digital logic until they are connected at the power entry point. Power to the ADS8406 should be clean and well bypassed. A 0.1- $\mu$ F ceramic bypass capacitor should be placed as close to the device as possible. See Table 2 for the placement of the capacitor. In addition, a 1- $\mu$ F to 10- $\mu$ F capacitor is recommended. In some situations, additional bypassing may be required, such as a 100- $\mu$ F electrolytic capacitor or even a Pi filter made up of inductors and capacitors—all designed to essentially low-pass filter the 5-V supply, removing the high frequency noise.

**Table 2. Power Supply Decoupling Capacitor Placement**

POWER SUPPLY PLANE SUPPLY PINS	CONVERTER ANALOG SIDE	CONVERTER DIGITAL SIDE
Pin pairs that require shortest path to decoupling capacitors	(4,5), (8,9), (10,11), (13,15), (43,44), (45,46)	(24,25), (34, 35)
Pins that require no decoupling	12, 14	37

## PACKAGING INFORMATION

Orderable Device	Status (1)	Package Type	Package Drawing	Pins	Package Qty	Eco Plan (2)	Lead/Ball Finish (6)	MSL Peak Temp (3)	Op Temp (°C)	Device Marking (4/5)	Samples
ADS8406IBPFBR	ACTIVE	TQFP	PFB	48	2000	Green (RoHS & no Sb/Br)	CU NIPDAU	Level-2-260C-1 YEAR	-40 to 85	ADS8406I B	<a href="#">Samples</a>
ADS8406IBPFBT	ACTIVE	TQFP	PFB	48	250	Green (RoHS & no Sb/Br)	CU NIPDAU	Level-2-260C-1 YEAR	-40 to 85	ADS8406I B	<a href="#">Samples</a>
ADS8406IBPFBTG4	ACTIVE	TQFP	PFB	48	250	Green (RoHS & no Sb/Br)	CU NIPDAU	Level-2-260C-1 YEAR	-40 to 85	ADS8406I B	<a href="#">Samples</a>
ADS8406IPFBT	LIFEBUY	TQFP	PFB	48	250	Green (RoHS & no Sb/Br)	CU NIPDAU	Level-2-260C-1 YEAR	-40 to 85	ADS8406I	
ADS8406IPFBTG4	LIFEBUY	TQFP	PFB	48	250	Green (RoHS & no Sb/Br)	CU NIPDAU	Level-2-260C-1 YEAR	-40 to 85	ADS8406I	

(1) The marketing status values are defined as follows:

**ACTIVE:** Product device recommended for new designs.

**LIFEBUY:** TI has announced that the device will be discontinued, and a lifetime-buy period is in effect.

**NRND:** Not recommended for new designs. Device is in production to support existing customers, but TI does not recommend using this part in a new design.

**PREVIEW:** Device has been announced but is not in production. Samples may or may not be available.

**OBSOLETE:** TI has discontinued the production of the device.

(2) **RoHS:** TI defines "RoHS" to mean semiconductor products that are compliant with the current EU RoHS requirements for all 10 RoHS substances, including the requirement that RoHS substance do not exceed 0.1% by weight in homogeneous materials. Where designed to be soldered at high temperatures, "RoHS" products are suitable for use in specified lead-free processes. TI may reference these types of products as "Pb-Free".

**RoHS Exempt:** TI defines "RoHS Exempt" to mean products that contain lead but are compliant with EU RoHS pursuant to a specific EU RoHS exemption.

**Green:** TI defines "Green" to mean the content of Chlorine (Cl) and Bromine (Br) based flame retardants meet JS709B low halogen requirements of <=1000ppm threshold. Antimony trioxide based flame retardants must also meet the <=1000ppm threshold requirement.

(3) MSL, Peak Temp. - The Moisture Sensitivity Level rating according to the JEDEC industry standard classifications, and peak solder temperature.

(4) There may be additional marking, which relates to the logo, the lot trace code information, or the environmental category on the device.

(5) Multiple Device Markings will be inside parentheses. Only one Device Marking contained in parentheses and separated by a "-" will appear on a device. If a line is indented then it is a continuation of the previous line and the two combined represent the entire Device Marking for that device.

(6) Lead/Ball Finish - Orderable Devices may have multiple material finish options. Finish options are separated by a vertical ruled line. Lead/Ball Finish values may wrap to two lines if the finish value exceeds the maximum column width.

**Important Information and Disclaimer:** The information provided on this page represents TI's knowledge and belief as of the date that it is provided. TI bases its knowledge and belief on information provided by third parties, and makes no representation or warranty as to the accuracy of such information. Efforts are underway to better integrate information from third parties. TI has taken and continues to take reasonable steps to provide representative and accurate information but may not have conducted destructive testing or chemical analysis on incoming materials and chemicals. TI and TI suppliers consider certain information to be proprietary, and thus CAS numbers and other limited information may not be available for release.

In no event shall TI's liability arising out of such information exceed the total purchase price of the TI part(s) at issue in this document sold by TI to Customer on an annual basis.

## TAPE AND REEL INFORMATION



### QUADRANT ASSIGNMENTS FOR PIN 1 ORIENTATION IN TAPE



\*All dimensions are nominal

Device	Package Type	Package Drawing	Pins	SPQ	Reel Diameter (mm)	Reel Width W1 (mm)	A0 (mm)	B0 (mm)	K0 (mm)	P1 (mm)	W (mm)	Pin1 Quadrant
ADS8406IBPFBR	TQFP	PFB	48	2000	330.0	16.4	9.6	9.6	1.5	12.0	16.0	Q2
ADS8406IBPFBT	TQFP	PFB	48	250	180.0	16.4	9.6	9.6	1.5	12.0	16.0	Q2
ADS8406IPFBT	TQFP	PFB	48	250	180.0	16.4	9.6	9.6	1.5	12.0	16.0	Q2

**TAPE AND REEL BOX DIMENSIONS**

\*All dimensions are nominal

Device	Package Type	Package Drawing	Pins	SPQ	Length (mm)	Width (mm)	Height (mm)
ADS8406IBPFBR	TQFP	PFB	48	2000	350.0	350.0	43.0
ADS8406IBPFBT	TQFP	PFB	48	250	213.0	191.0	55.0
ADS8406IPFBT	TQFP	PFB	48	250	213.0	191.0	55.0

PFB (S-PQFP-G48)

PLASTIC QUAD FLATPACK

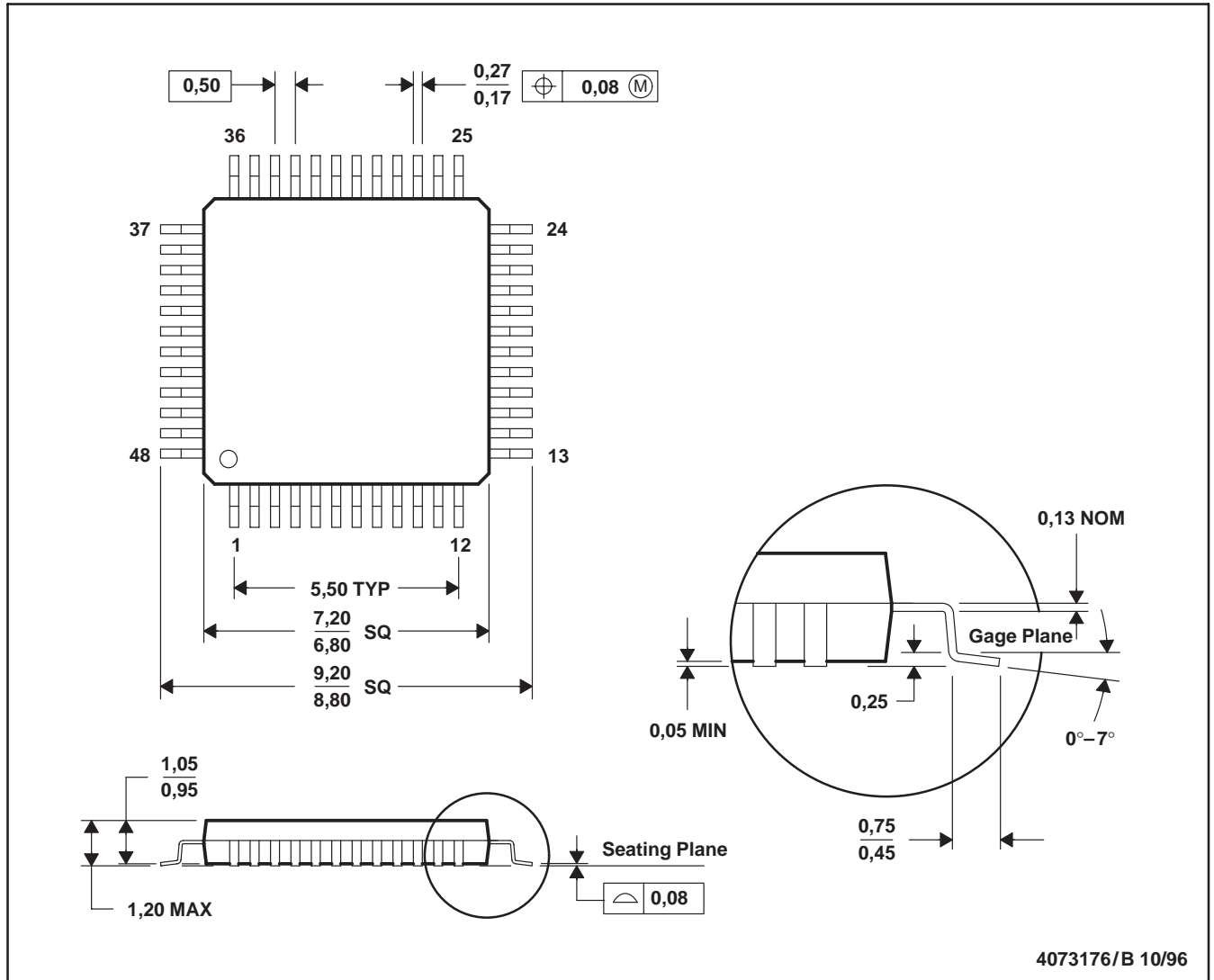

- NOTES: A. All linear dimensions are in millimeters.  
 B. This drawing is subject to change without notice.  
 C. Falls within JEDEC MS-026

PFB (S-PQFP-G48)



- NOTES:
- A. All linear dimensions are in millimeters.
  - B. This drawing is subject to change without notice.
  - C. Publication IPC-7351 is recommended for alternate designs.
  - D. Laser cutting apertures with trapezoidal walls and also rounding corners will offer better paste release. Customers should contact their board assembly site for stencil design recommendations. Refer to IPC-7525.
  - E. Customers should contact their board fabrication site for solder mask tolerances between and around signal pads.

## IMPORTANT NOTICE AND DISCLAIMER

TI PROVIDES TECHNICAL AND RELIABILITY DATA (INCLUDING DATASHEETS), DESIGN RESOURCES (INCLUDING REFERENCE DESIGNS), APPLICATION OR OTHER DESIGN ADVICE, WEB TOOLS, SAFETY INFORMATION, AND OTHER RESOURCES "AS IS" AND WITH ALL FAULTS, AND DISCLAIMS ALL WARRANTIES, EXPRESS AND IMPLIED, INCLUDING WITHOUT LIMITATION ANY IMPLIED WARRANTIES OF MERCHANTABILITY, FITNESS FOR A PARTICULAR PURPOSE OR NON-INFRINGEMENT OF THIRD PARTY INTELLECTUAL PROPERTY RIGHTS.

These resources are intended for skilled developers designing with TI products. You are solely responsible for (1) selecting the appropriate TI products for your application, (2) designing, validating and testing your application, and (3) ensuring your application meets applicable standards, and any other safety, security, or other requirements. These resources are subject to change without notice. TI grants you permission to use these resources only for development of an application that uses the TI products described in the resource. Other reproduction and display of these resources is prohibited. No license is granted to any other TI intellectual property right or to any third party intellectual property right. TI disclaims responsibility for, and you will fully indemnify TI and its representatives against, any claims, damages, costs, losses, and liabilities arising out of your use of these resources.

TI's products are provided subject to TI's Terms of Sale ([www.ti.com/legal/termsofsale.html](http://www.ti.com/legal/termsofsale.html)) or other applicable terms available either on [ti.com](http://ti.com) or provided in conjunction with such TI products. TI's provision of these resources does not expand or otherwise alter TI's applicable warranties or warranty disclaimers for TI products.

Mailing Address: Texas Instruments, Post Office Box 655303, Dallas, Texas 75265  
Copyright © 2019, Texas Instruments Incorporated

## Looking for pricing, stock, or lifecycle information?

Click below to explore more details on WIN SOURCE:

 [View ADS8406IBPFBT](#) on WIN SOURCE

 [Texas Instruments](#) Information

## Optimize Your Supply Chain with WIN SOURCE Solutions

-  Global Sourcing Solution
-  Obsolete Management
-  Cost Control Management
-  Shortage Management
-  Alternative Solution
-  Excess Inventory Management