



**THE DATASHEET OF
AFT18P350-4S2LR6**





RF Power LDMOS Transistor

N-Channel Enhancement-Mode Lateral MOSFET

This 63 watt symmetrical Doherty RF power LDMOS transistor is designed for cellular base station applications covering the frequency range of 1805 to 1880 MHz.

- Typical Doherty Single-Carrier W-CDMA Performance: $V_{DD} = 28$ Volts, $I_{DQA} = 1000$ mA, $V_{GSB} = 1.2$ Vdc, $P_{out} = 63$ Watts Avg., Input Signal PAR = 9.9 dB @ 0.01% Probability on CCDF.

Frequency	G_{ps} (dB)	η_D (%)	Output PAR (dB)	ACPR (dBc)
1805 MHz	16.1	44.5	7.7	-29.8
1840 MHz	16.1	44.3	7.7	-31.6
1880 MHz	15.8	44.1	7.6	-33.0

Features

- Production Tested in a Symmetrical Doherty Configuration
- Greater Negative Gate-Source Voltage Range for Improved Class C Operation
- Designed for Digital Predistortion Error Correction Systems
- In Tape and Reel. R6 Suffix = 150 Units, 56 mm Tape Width, 13-inch Reel.

AFT18P350-4S2LR6

1805-1880 MHz, 63 W AVG., 28 V

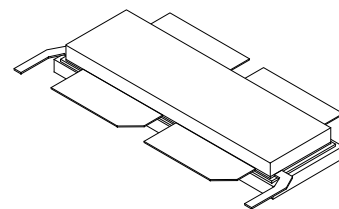

NI-1230-4LS2L

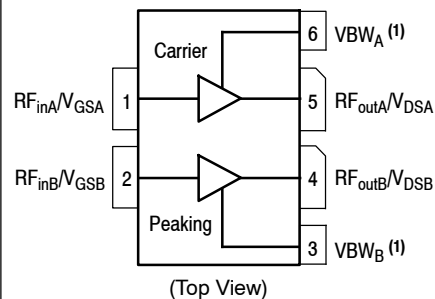

Figure 1. Pin Connections

1. Device cannot operate with the V_{DD} current supplied through pin 3 and pin 6.

Table 1. Maximum Ratings

Rating	Symbol	Value	Unit
Drain-Source Voltage	V_{DSS}	-0.5, +65	Vdc
Gate-Source Voltage	V_{GS}	-6.0, +10	Vdc
Operating Voltage	V_{DD}	32, +0	Vdc
Storage Temperature Range	T_{stg}	-65 to +150	°C
Case Operating Temperature Range	T_C	-40 to +150	°C
Operating Junction Temperature Range (1,2)	T_J	-40 to +225	°C
CW Operation @ $T_C = 25^\circ\text{C}$ Derate above 25°C	CW	374 3.2	W W/°C

Table 2. Thermal Characteristics

Characteristic	Symbol	Value (2,3)	Unit
Thermal Resistance, Junction to Case Case Temperature 75°C , 63 W W-CDMA, 28 Vdc, $I_{DQA} = 1000\text{ mA}$, $V_{GSB} = 1.2\text{ Vdc}$, 1805 MHz	$R_{\theta JC}$	0.39	°C/W

Table 3. ESD Protection Characteristics

Test Methodology	Class
Human Body Model (per JESD22-A114)	2
Machine Model (per EIA/JESD22-A115)	B
Charge Device Model (per JESD22-C101)	IV

Table 4. Electrical Characteristics ($T_A = 25^\circ\text{C}$ unless otherwise noted)

Characteristic	Symbol	Min	Typ	Max	Unit
----------------	--------	-----	-----	-----	------

Off Characteristics (4)

Zero Gate Voltage Drain Leakage Current ($V_{DS} = 65\text{ Vdc}$, $V_{GS} = 0\text{ Vdc}$)	I_{DSS}	—	—	10	μAdc
Zero Gate Voltage Drain Leakage Current ($V_{DS} = 28\text{ Vdc}$, $V_{GS} = 0\text{ Vdc}$)	I_{DSS}	—	—	1	μAdc
Gate-Source Leakage Current ($V_{GS} = 5\text{ Vdc}$, $V_{DS} = 0\text{ Vdc}$)	I_{GSS}	—	—	1	μAdc

On Characteristics

Gate Threshold Voltage (4) ($V_{DS} = 10\text{ Vdc}$, $I_D = 240\ \mu\text{Adc}$)	$V_{GS(th)}$	1.5	1.9	2.5	Vdc
Gate Quiescent Voltage ($V_{DD} = 28\text{ Vdc}$, $I_{DA} = 1000\text{ mAdc}$, Measured in Functional Test)	$V_{GS(Q)}$	2.3	2.7	3.3	Vdc
Drain-Source On-Voltage (4) ($V_{GS} = 10\text{ Vdc}$, $I_D = 2.75\text{ Adc}$)	$V_{DS(on)}$	0.1	0.2	0.3	Vdc

1. Continuous use at maximum temperature will affect MTTF.
2. MTTF calculator available at <http://www.freescale.com/rf>. Select Software & Tools/Development Tools/Calculators to access MTTF calculators by product.
3. Refer to AN1955, *Thermal Measurement Methodology of RF Power Amplifiers*. Go to <http://www.freescale.com/rf>. Select Documentation/Application Notes - AN1955.
4. Each side of device measured separately.

(continued)

Table 4 . Electrical Characteristics ($T_A = 25^\circ\text{C}$ unless otherwise noted) (continued)

Characteristic	Symbol	Min	Typ	Max	Unit
Functional Tests ^(1,2) (In Freescale Doherty Test Fixture, 50 ohm system) $V_{DD} = 28\text{ Vdc}$, $I_{DQA} = 1000\text{ mA}$, $V_{GSB} = 1.2\text{ Vdc}$, $P_{out} = 63\text{ W Avg.}$, $f = 1805\text{ MHz}$, Single-Carrier W-CDMA, IQ Magnitude Clipping, Input Signal PAR = 9.9 dB @ 0.01% Probability on CCDF. ACPR measured in 3.84 MHz Channel Bandwidth @ $\pm 5\text{ MHz}$ Offset.					
Power Gain	G_{ps}	15.0	16.1	18.0	dB
Drain Efficiency	η_D	41.0	44.5	—	%
Output Peak-to-Average Ratio @ 0.01% Probability on CCDF	PAR	7.2	7.7	—	dB
Adjacent Channel Power Ratio	ACPR	—	-29.8	-27.0	dBc

Load Mismatch (In Freescale Test Fixture, 50 ohm system) $I_{DQA} = 1000\text{ mA}$, $f = 1840\text{ MHz}$

VSWR 10:1 at 32 Vdc, 414 W CW ⁽³⁾ Output Power (3 dB Input Overdrive from 316 W CW Rated Power)	No Device Degradation
---	-----------------------

Typical Performance ⁽²⁾ (In Freescale Doherty Test Fixture, 50 ohm system) $V_{DD} = 28\text{ Vdc}$, $I_{DQA} = 1000\text{ mA}$, $V_{GSB} = 1.2\text{ Vdc}$, 1805-1880 MHz Bandwidth

P_{out} @ 1 dB Compression Point, CW	P1dB	—	316	—	W
P_{out} @ 3 dB Compression Point ⁽⁴⁾	P3dB	—	394	—	W
AM/PM (Maximum value measured at the P3dB compression point across the 1805-1880 MHz bandwidth)	Φ	—	31	—	°
VBW Resonance Point (IMD Third Order Intermodulation Inflection Point)	VBW_{res}	—	90	—	MHz
Gain Flatness in 75 MHz Bandwidth @ $P_{out} = 63\text{ W Avg.}$	G_F	—	0.4	—	dB
Gain Variation over Temperature (-30°C to +85°C)	ΔG	—	0.01	—	dB/°C
Output Power Variation over Temperature (-30°C to +85°C) ⁽³⁾	$\Delta P1dB$	—	0.005	—	dB/°C

1. Part internally matched both on input and output.
2. Measurements made with device in a symmetrical Doherty configuration.
3. Exceeds recommended operating conditions. See CW operation data in Maximum Ratings table.
4. P3dB = $P_{avg} + 7.0\text{ dB}$ where P_{avg} is the average output power measured using an unclipped W-CDMA single-carrier input signal where output PAR is compressed to 7.0 dB @ 0.01% probability on CCDF.

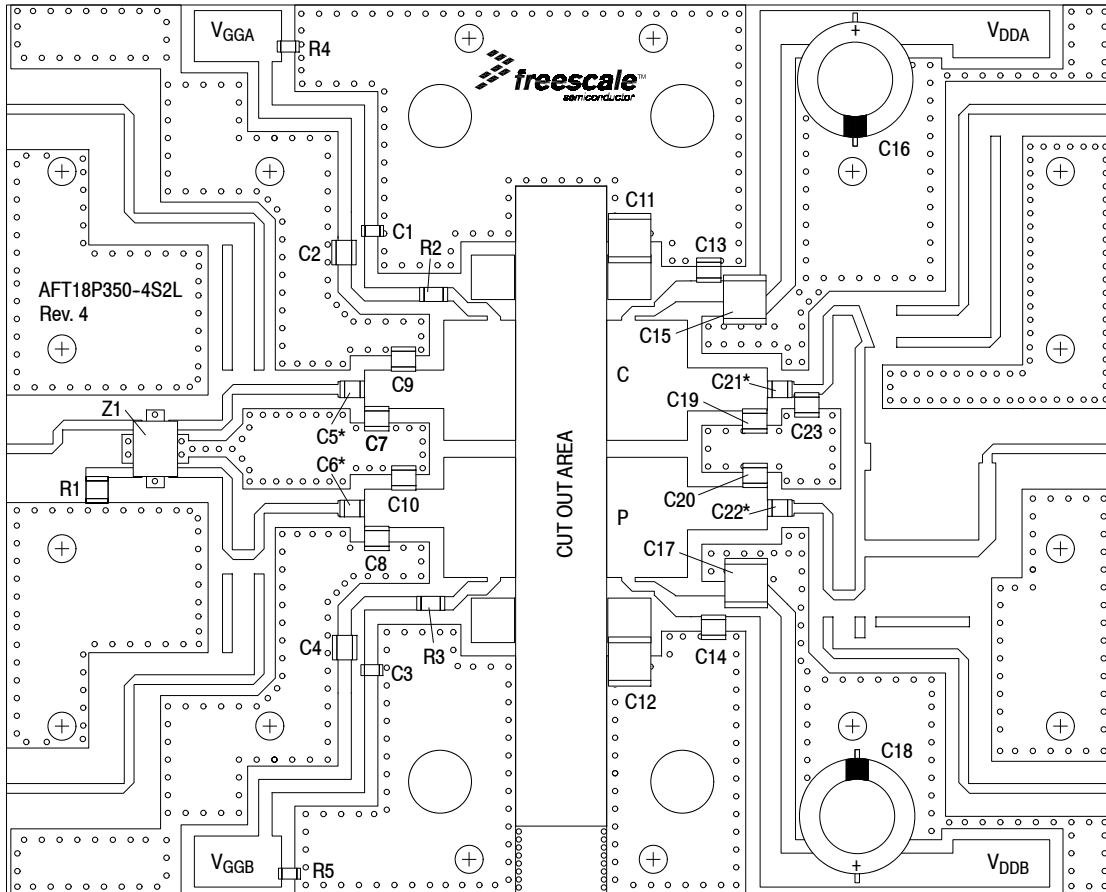

*C5, C6, C21 and C22 are mounted vertically.

Figure 2. AFT18P350-4S2LR6 Test Circuit Component Layout

Table 5. AFT18P350-4S2LR6 Test Circuit Component Designations and Values

Part	Description	Part Number	Manufacturer
C1, C3	10 μ F, 50 V Chip Capacitors	GRM31CR61H106KA12L	Murata
C2, C4, C5, C6, C13, C14, C21, C22	12 pF Chip Capacitors	ATC100B120JT500XT	ATC
C7, C8, C9, C10	0.3 pF Chip Capacitors	ATC100B0R3BT500XT	ATC
C11, C12, C15, C17	10 μ F, 100 V Chip Capacitors	C5750X7S2A106M	TDK
C16, C18	470 μ F, 63 V Electrolytic Capacitors	MCGPR63V477M13X26-RH	Multicomp
C19	0.5 pF Chip Capacitor	ATC100B0R5BT500XT	ATC
C20	0.6 pF Chip Capacitor	ATC100B0R6BT500XT	ATC
C23	0.4 pF Chip Capacitor	ATC100B0R4BT500XT	ATC
R1	50 Ω , 10 W Chip Resistor	CW12010T0050GBK	ATC
R2, R3	2.7 Ω , 1/4 W Chip Resistors	CRCW12062R70FNEA	Vishay
R4, R5	1.8 k Ω , 1/4 W Chip Resistors	CRCW12061K80FKEA	Vishay
Z1	1700-2000 MHz Band 90°, 3 dB Hybrid Coupler	X3C19P1-03S	Anaren
PCB	0.020", $\epsilon_r = 3.50$	RO4350B	Rogers

TYPICAL CHARACTERISTICS

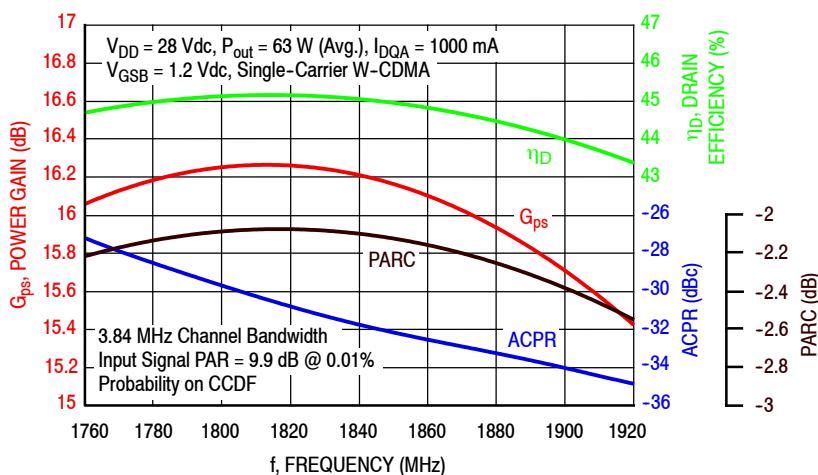

Figure 3. Single-Carrier Output Peak-to-Average Ratio Compression (PARC) Broadband Performance @ $P_{out} = 63$ Watts Avg.

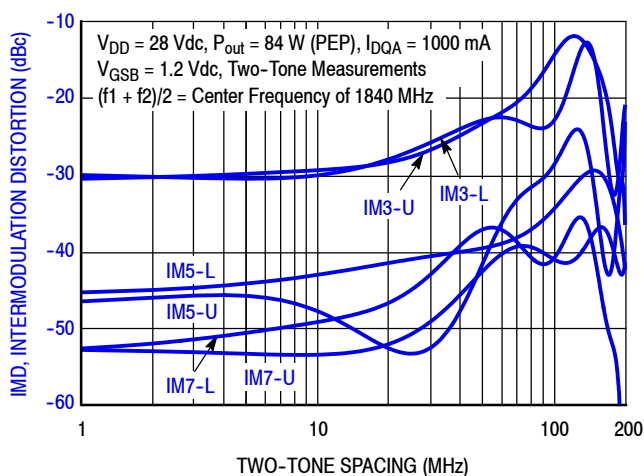

Figure 4. Intermodulation Distortion Products versus Two-Tone Spacing

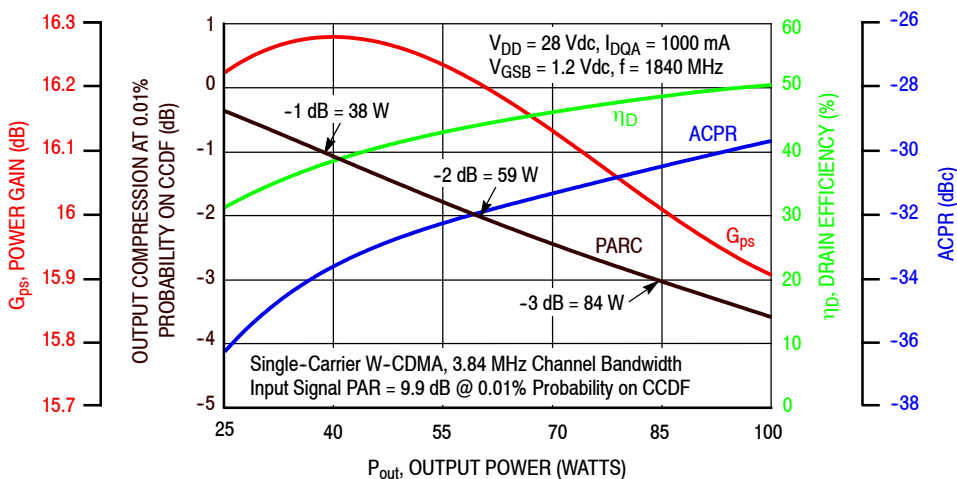

Figure 5. Output Peak-to-Average Ratio Compression (PARC) versus Output Power

TYPICAL CHARACTERISTICS

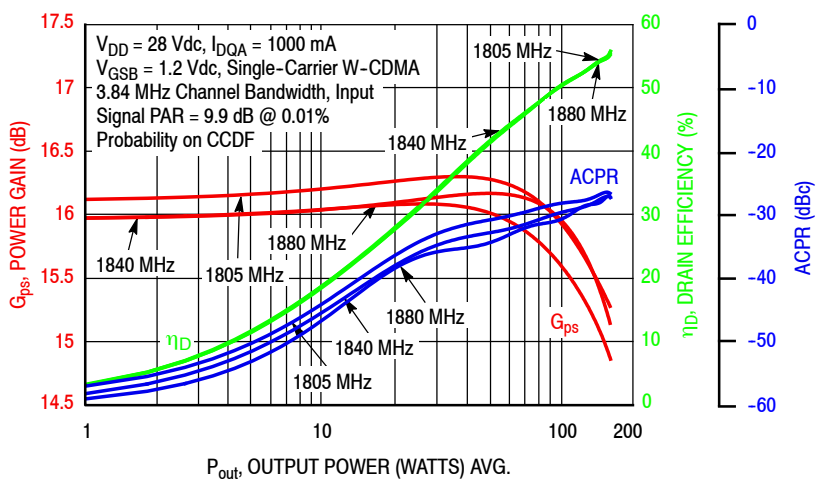

Figure 6. Single-Carrier W-CDMA Power Gain, Drain Efficiency and ACPR versus Output Power

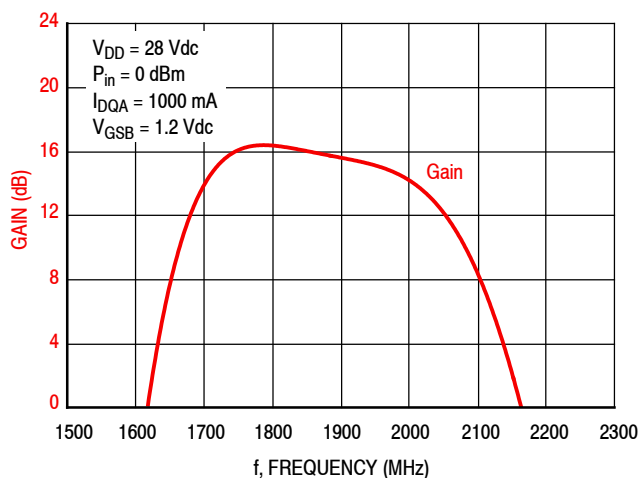

Figure 7. Broadband Frequency Response

$V_{DD} = 28 \text{ Vdc}$, $I_{DQA} = 1276 \text{ mA}$, Pulsed CW, 10 $\mu\text{sec(ON)}$, 10% Duty Cycle

f (MHz)	$Z_{\text{source}} (\Omega)$	$Z_{\text{in}} (\Omega)$	Max Output Power					
			P1dB					
			$Z_{\text{load}}^{(1)} (\Omega)$	Gain (dB)	(dBm)	(W)	η_D (%)	AM/PM (°)
1800	1.66 - j4.48	1.68 + j4.49	1.39 - j3.55	17.5	53.6	227	54.5	-11
1840	2.33 - j4.85	2.36 + j5.08	1.47 - j3.87	17.6	53.5	225	53.7	-11
1880	3.53 - j5.49	3.63 + j5.63	1.55 - j4.21	17.6	53.6	229	55.3	-11

f (MHz)	$Z_{\text{source}} (\Omega)$	$Z_{\text{in}} (\Omega)$	Max Output Power					
			P3dB					
			$Z_{\text{load}}^{(2)} (\Omega)$	Gain (dB)	(dBm)	(W)	η_D (%)	AM/PM (°)
1800	1.66 - j4.48	1.62 + j4.65	1.38 - j3.74	15.3	54.4	276	56.8	-16
1840	2.33 - j4.85	2.35 + j5.32	1.46 - j4.07	15.3	54.4	272	55.5	-16
1880	3.53 - j5.49	3.75 + j6.00	1.57 - j4.37	15.4	54.4	277	57.3	-17

(1) Load impedance for optimum P1dB power.

(2) Load impedance for optimum P3dB power.

Z_{source} = Measured impedance presented to the input of the device at the package reference plane.

Z_{in} = Impedance as measured from gate contact to ground.

Z_{load} = Measured impedance presented to the output of the device at the package reference plane.

Figure 8. Single Side Load Pull Performance — Maximum Power Tuning

$V_{DD} = 28 \text{ Vdc}$, $I_{DQA} = 1276 \text{ mA}$, Pulsed CW, 10 $\mu\text{sec(ON)}$, 10% Duty Cycle

f (MHz)	$Z_{\text{source}} (\Omega)$	$Z_{\text{in}} (\Omega)$	Max Drain Efficiency					
			P1dB					
			$Z_{\text{load}}^{(1)} (\Omega)$	Gain (dB)	(dBm)	(W)	η_D (%)	AM/PM (°)
1800	1.66 - j4.48	1.77 + j4.81	3.13 - j2.02	20.4	51.4	139	65.6	-17
1840	2.33 - j4.85	2.56 + j5.32	2.91 - j2.41	20.2	51.6	146	64.2	-16
1880	3.53 - j5.49	3.98 + j5.87	2.61 - j2.54	20.1	51.7	148	65.6	-16

f (MHz)	$Z_{\text{source}} (\Omega)$	$Z_{\text{in}} (\Omega)$	Max Drain Efficiency					
			P3dB					
			$Z_{\text{load}}^{(2)} (\Omega)$	Gain (dB)	(dBm)	(W)	η_D (%)	AM/PM (°)
1800	1.66 - j4.48	1.73 + j4.80	3.06 - j2.93	17.8	52.8	190	67.3	-21
1840	2.33 - j4.85	2.53 + j5.48	2.88 - j2.69	17.9	52.6	183	66.6	-23
1880	3.53 - j5.49	4.06 + j6.19	2.55 - j2.65	18.0	52.5	180	67.8	-24

(1) Load impedance for optimum P1dB efficiency.

(2) Load impedance for optimum P3dB efficiency.

Z_{source} = Measured impedance presented to the input of the device at the package reference plane.

Z_{in} = Impedance as measured from gate contact to ground.

Z_{load} = Measured impedance presented to the output of the device at the package reference plane.

Figure 9. Single Side Load Pull Performance — Maximum Drain Efficiency Tuning

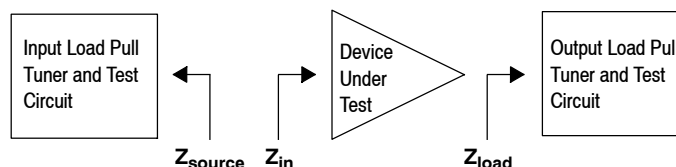

P1dB - TYPICAL LOAD PULL CONTOURS — 1840 MHz

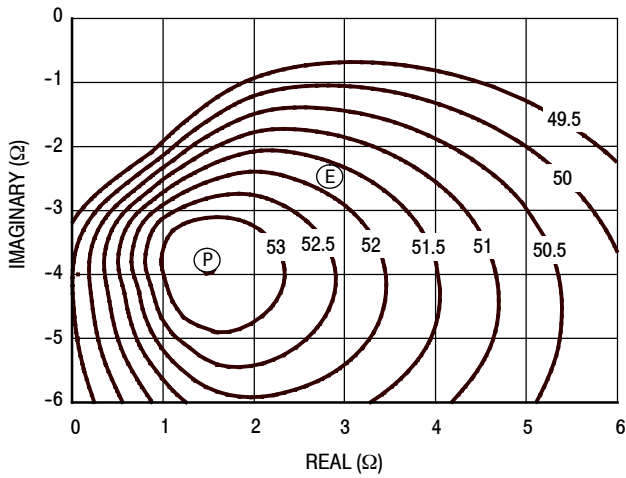

Figure 10. P1dB Load Pull Output Power Contours (dBm)

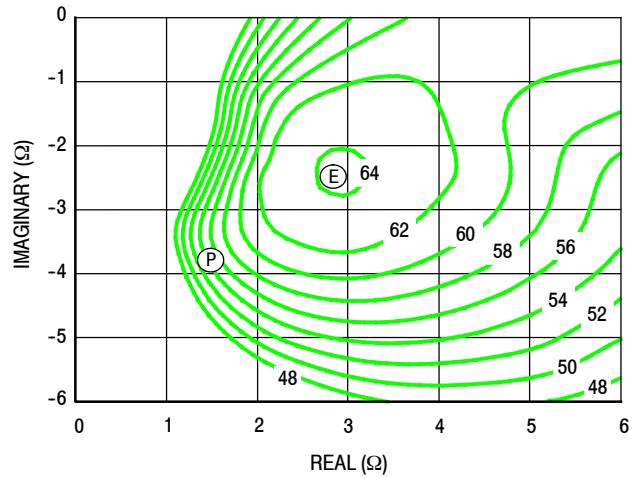

Figure 11. P1dB Load Pull Efficiency Contours (%)

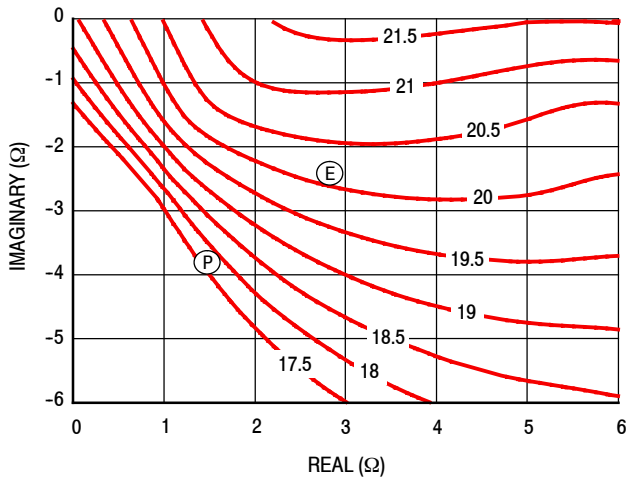

Figure 12. P1dB Load Pull Gain Contours (dB)

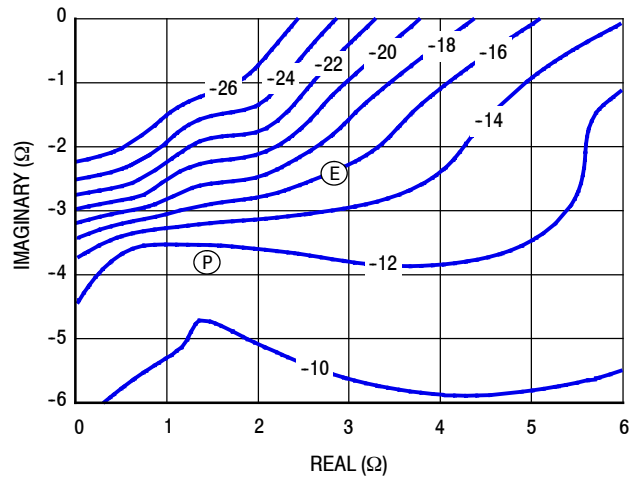

Figure 13. P1dB Load Pull AM/PM Contours (°)

NOTE: (P) = Maximum Output Power
 (E) = Maximum Drain Efficiency

- Power Gain
- Drain Efficiency
- Linearity
- Output Power

P3dB - TYPICAL LOAD PULL CONTOURS — 1840 MHz

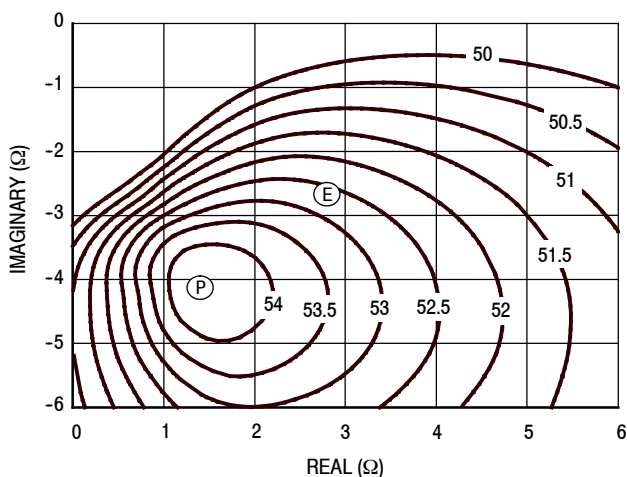

Figure 14. P3dB Load Pull Output Power Contours (dBm)

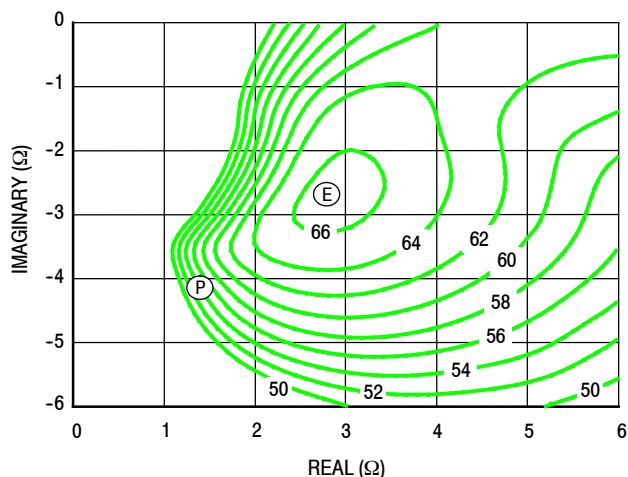

Figure 15. P3dB Load Pull Efficiency Contours (%)

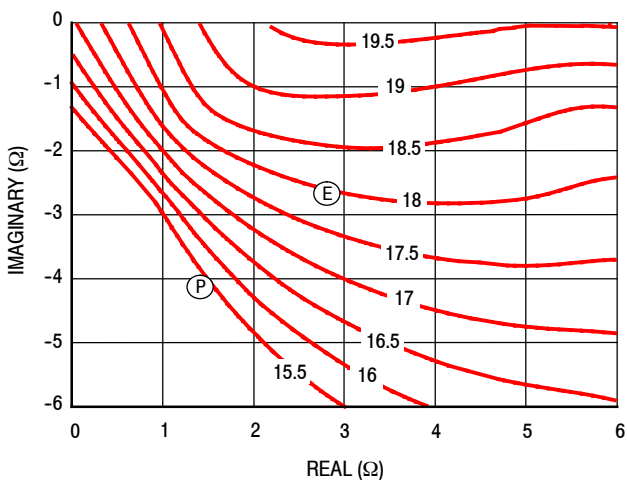

Figure 16. P3dB Load Pull Gain Contours (dB)

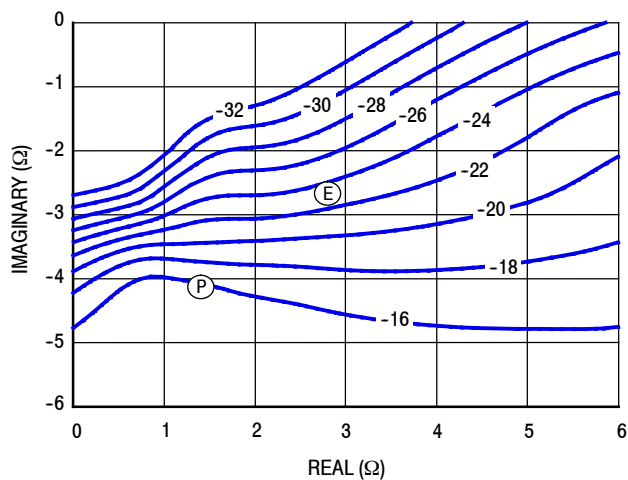
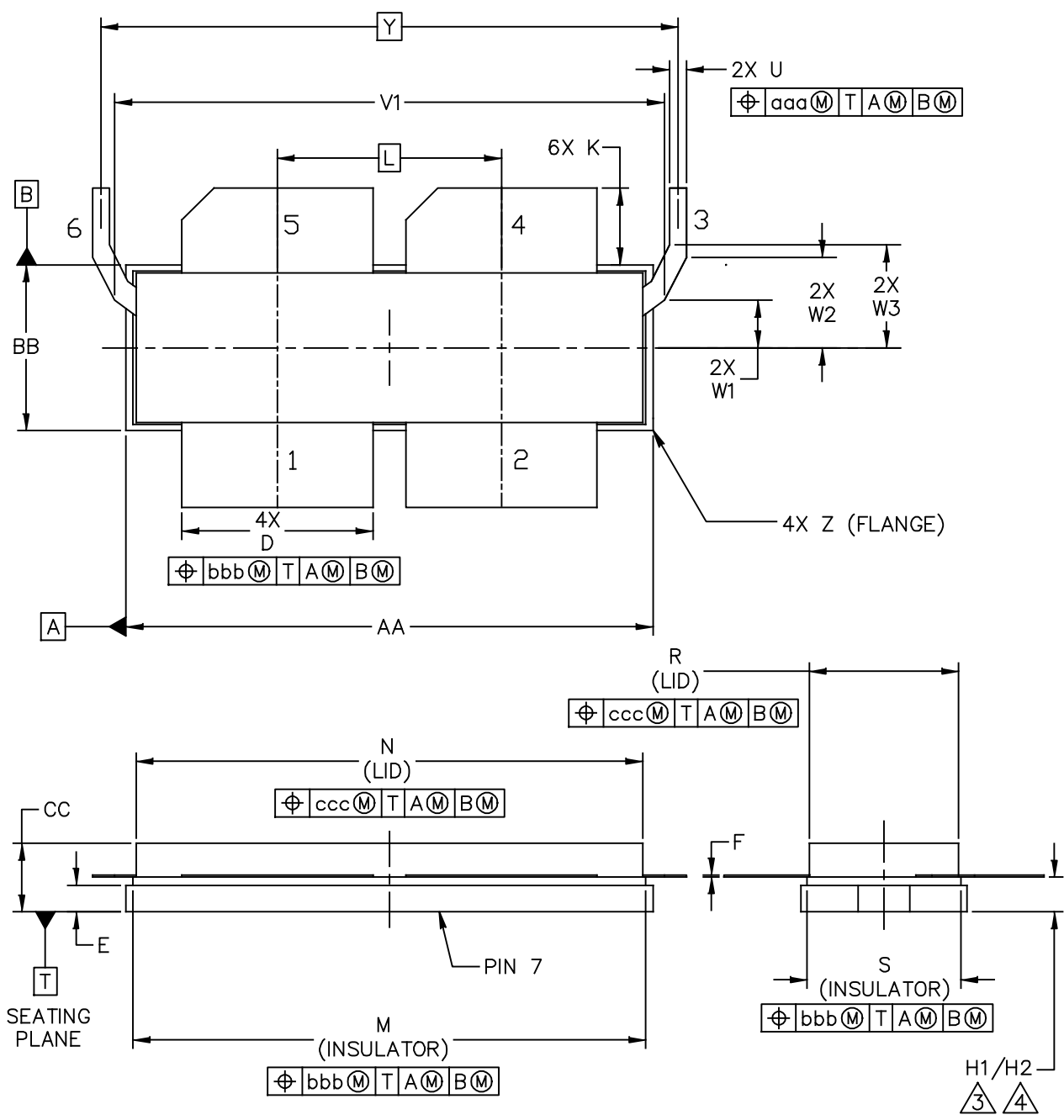

Figure 17. P3dB Load Pull AM/PM Contours (°)

NOTE: (P) = Maximum Output Power
 (E) = Maximum Drain Efficiency

- Power Gain
- Drain Efficiency
- Linearity
- Output Power

PACKAGE DIMENSIONS



© FREESCALE SEMICONDUCTOR, INC. ALL RIGHTS RESERVED.	MECHANICAL OUTLINE	PRINT VERSION NOT TO SCALE
TITLE: NI-1230-4LS2L	DOCUMENT NO: 98ASA00513D REV: A	
	STANDARD: NON-JEDEC	
	08 MAR 2013	

NOTES:

1. INTERPRET DIMENSIONS AND TOLERANCES PER ASME Y14.5M–1994.
2. CONTROLLING DIMENSION: INCH

3. DIMENSIONS H1 AND H2 ARE MEASURED .030 INCH (0.762 MM) AWAY FROM FLANGE PARALLEL TO DATUM B. H1 APPLIES TO PINS 1, 2, 4 & 5. H2 APPLIES TO PINS 3 & 6.

4. TOLERANCE OF DIMENSION H2 IS TENTATIVE AND COULD CHANGE ONCE SUFFICIENT MANUFACTURING DATA IS AVAILABLE.

DIM	INCH		MILLIMETER		DIM	INCH		MILLIMETER	
	MIN	MAX	MIN	MAX		MIN	MAX	MIN	MAX
AA	1.265	1.275	32.13	32.39	N	1.218	1.242	30.94	31.55
BB	.395	.405	10.03	10.29	R	.365	.375	9.27	9.53
CC	.170	.190	4.32	4.83	S	.365	.375	9.27	9.53
D	.455	.465	11.56	11.81	U	.035	.045	0.89	1.14
E	.062	.066	1.57	1.68	V1	1.320	1.330	33.53	33.78
F	.004	.007	0.10	0.18	W1	.110	.120	2.79	3.05
H1	.082	.090	2.08	2.29	W2	.213	.223	5.41	5.66
H2	.078	.094	1.98	2.39	W3	.243	.253	6.17	6.43
K	.175	.195	4.45	4.95	Y	1.390 BSC		35.31 BSC	
L	.540 BSC		13.72 BSC		Z	R.000	R.040	R0.00	R1.02
M	1.219	1.241	30.96	31.52	aaa	.015		0.38	
					bbb	.010		0.25	
					ccc	.020		0.51	
© FREESCALE SEMICONDUCTOR, INC. ALL RIGHTS RESERVED.			MECHANICAL OUTLINE			PRINT VERSION NOT TO SCALE			
TITLE:					DOCUMENT NO: 98ASA00513D			REV: A	
NI-1230-4LS2L					STANDARD: NON-JEDEC				
					08 MAR 2013				

PRODUCT DOCUMENTATION, SOFTWARE AND TOOLS

Refer to the following documents, software and tools to aid your design process.

Application Notes

- AN1955: Thermal Measurement Methodology of RF Power Amplifiers

Engineering Bulletins

- EB212: Using Data Sheet Impedances for RF LDMOS Devices

Software

- Electromigration MTTF Calculator
- RF High Power Model
- .s2p File

Development Tools

- Printed Circuit Boards

For Software and Tools, do a Part Number search at <http://www.freescale.com>, and select the “Part Number” link. Go to the Software & Tools tab on the part’s Product Summary page to download the respective tool.

REVISION HISTORY

The following table summarizes revisions to this document.

Revision	Date	Description
0	Apr. 2013	• Initial Release of Data Sheet

How to Reach Us:

Home Page:
freescale.com

Web Support:
freescale.com/support

Information in this document is provided solely to enable system and software implementers to use Freescale products. There are no express or implied copyright licenses granted hereunder to design or fabricate any integrated circuits based on the information in this document.

Freescale reserves the right to make changes without further notice to any products herein. Freescale makes no warranty, representation, or guarantee regarding the suitability of its products for any particular purpose, nor does Freescale assume any liability arising out of the application or use of any product or circuit, and specifically disclaims any and all liability, including without limitation consequential or incidental damages. "Typical" parameters that may be provided in Freescale data sheets and/or specifications can and do vary in different applications, and actual performance may vary over time. All operating parameters, including "typicals," must be validated for each customer application by customer's technical experts. Freescale does not convey any license under its patent rights nor the rights of others. Freescale sells products pursuant to standard terms and conditions of sale, which can be found at the following address: freescale.com/SalesTermsandConditions.

Freescale and the Freescale logo are trademarks of Freescale Semiconductor, Inc., Reg. U.S. Pat. & Tm. Off. Airfast is a trademark of Freescale Semiconductor, Inc. All other product or service names are the property of their respective owners.

© 2013 Freescale Semiconductor, Inc.

Looking for pricing, stock, or lifecycle information?

Click below to explore more details on WIN SOURCE:

 [View AFT18P350-4S2LR6 on WIN SOURCE](#)

 [NXP / Nexperia Information](#)

Optimize Your Supply Chain with WIN SOURCE Solutions

-  Global Sourcing Solution
-  Obsolete Management
-  Cost Control Management
-  Shortage Management
-  Alternative Solution
-  Excess Inventory Management