



**THE DATASHEET OF  
AL8807EV3**



## Description

The AL8807 is a step-down DC/DC converter designed to drive LEDs with a constant current. The device can drive up to 9 LEDs, depending on the forward voltage of the LEDs, in series from a voltage source of 6V to 36V. Series connection of the LEDs provides identical LED currents resulting in uniform brightness and eliminating the need for ballast resistors. The AL8807 switches at frequency up to 1MHz with controlled rise and fall times to reduce EMI. This allows the use of small size external components, hence minimizing the PCB area needed.

Maximum output current of AL8807 is set via an external resistor connected between the  $V_{IN}$  and SET input pins. Dimming is achieved by applying either a DC voltage or a PWM signal at the CTRL input pin. An input voltage of 0.4V or lower at CTRL switches off the output MOSFET simplifying PWM dimming.

## Features

- LED Driving Current up to 1.3A (MSOP-8EP)
- Better Than 5% Accuracy
- High Efficiency up to 96%
- Optimally Controlled Switching Speeds
- Operating Input Voltage from 6V to 36V
- PWM/DC Input for Dimming Control
- Built-In Output Open-Circuit Protection
- SOT25, MSOP-8EP: Available in "Green" Molding Compound (No Br, Sb)
- **Totally Lead-Free & Fully RoHS Compliant (Notes 1 & 2)**
- **Halogen and Antimony Free. "Green" Device (Note 3)**

Notes: 1. No purposely added lead. Fully EU Directive 2002/95/EC (RoHS) & 2011/65/EU (RoHS 2) compliant.  
2. See [http://www.diodes.com/quality/lead\\_free.html](http://www.diodes.com/quality/lead_free.html) for more information about Diodes Incorporated's definitions of Halogen- and Antimony-free, "Green" and Lead-free.  
3. Halogen- and Antimony-free "Green" products are defined as those which contain <900ppm bromine, <900ppm chlorine (<1500ppm total Br + Cl) and <1000ppm antimony compounds.

## Pin Assignments

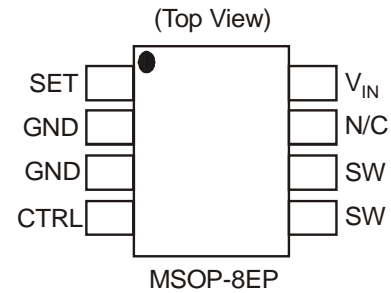
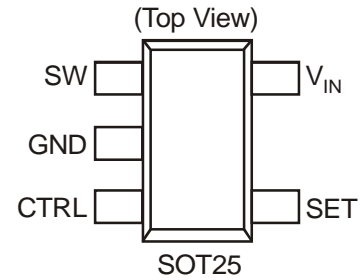

## Applications

- MR16 Lamps
- General Illumination Lamps
- 12V Powered LED Lamps
- 24V Powered LED Lamps

## Typical Applications Circuit

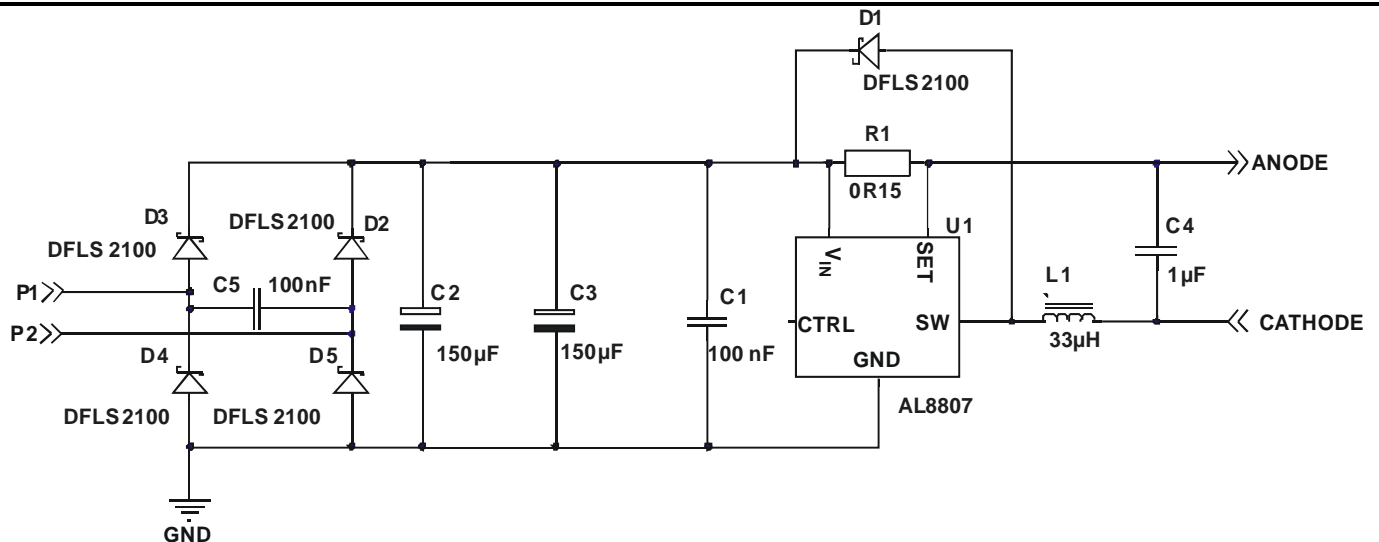

## Pin Descriptions

Pin Name	Pin Number		Function
	SOT25	MSOP-8EP	
SW	1	5, 6	Switch Pin. Connect inductor/freewheeling diode here, minimizing track length at this pin to reduce EMI.
GND	2	2, 3	GND Pin
CTRL	3	4	Dimming and On/Off Control Input. <ul style="list-style-type: none"> <li>Leave floating for normal operation. (<math>V_{CTRL} = V_{REF} = 2.5V</math> giving nominal average output current <math>I_{OUTnom} = 0.1/R_s</math>)</li> <li>Drive to voltage below 0.4V to turn off output current</li> <li>Drive with DC voltage (<math>0.5V &lt; V_{CTRL} &lt; 2.5V</math>) to adjust output current from 20% to 100% of <math>I_{OUTnom}</math></li> <li>A PWM signal (low level <math>\leq 0.4V</math> and high level <math>&gt; 2.6</math>; transition times less than 1us) allows the output current to be adjusted below the level set by the resistor connected to SET input pin.</li> </ul>
SET	4	1	Set Nominal Output Current Pin. Configure the output current of the device.
$V_{IN}$	5	8	Input Supply Pin. Must be locally decoupled to GND with $\geq 2.2\mu F$ X7R ceramic capacitor – see applications section for more information.
EP	—	EP	Exposed pad/TAB connect to GND and thermal mass for enhanced thermal impedance. Should not be used as electrical ground conduction path.
N/C	—	7	No Connection

## Absolute Maximum Ratings (@ $T_A = +25^\circ C$ , unless otherwise specified.)

Symbol	Parameter	Ratings	Unit
ESD HBM	Human Body Model ESD Protection	2.5	kV
ESD MM	Machine Model ESD Protection	200	V
$V_{IN}$	Continuous $V_{IN}$ Pin Voltage Relative to GND	-0.3 to +40	V
$V_{SW}$	SW Voltage Relative to GND	-0.3 to +40	V
$V_{CTRL}$	CTRL Pin Input Voltage	-0.3 to +6	V
$I_{SW-RMS}$	DC or RMS Switch Current	SOT25	1.25
		MSOP-8EP	1.6
$I_{SW-PK}$	Peak Switch Current (<10%)	2.5	A
$T_J$	Junction Temperature	150	$^\circ C$
$T_{LEAD}$	Lead Temperature Soldering	300	$^\circ C$
$T_{ST}$	Storage Temperature Range	-65 to +150	$^\circ C$

Caution: Stresses greater than the 'Absolute Maximum Ratings' specified above, may cause permanent damage to the device. These are stress ratings only; functional operation of the device at these or any other conditions exceeding those indicated in this specification is not implied. Device reliability may be affected by exposure to absolute maximum rating conditions for extended periods of time. Semiconductor devices are ESD sensitive and may be damaged by exposure to ESD events. Suitable ESD precautions should be taken when handling and transporting these devices.

## Recommended Operating Conditions (@ $T_A = +25^\circ C$ , unless otherwise specified.)

Symbol	Parameter	Min	Max	Unit
$V_{IN}$	Operating Input Voltage Relative to GND	6.0	36	V
$V_{CTRLH}$	Voltage High for PWM Dimming Relative to GND	2.6	5.5	V
$V_{CTRLDC}$	Voltage Range for 20% to 100% DC Dimming Relative to GND	0.5	2.5	V
$V_{CTRLLL}$	Voltage Low for PWM Dimming Relative to GND	0	0.4	V
$f_{SW}$	Maximum Switching Frequency		1	MHz
$I_{SW}$	Continuous Switch Current	SOT25	1	A
		MSOP-8EP	1.3	
$T_J$	Junction Temperature Range	-40	+125	$^\circ C$

### Electrical Characteristics (@ $V_{IN} = 12$ , $T_A = +25^\circ\text{C}$ , unless otherwise specified.)

Symbol	Parameter	Conditions	Min	Typ	Max	Unit
$V_{INSU}$	Internal Regulator Start-Up Threshold	$V_{IN}$ rising			5.9	V
$V_{INSH}$	Internal Regulator Hysteresis Threshold	$V_{IN}$ falling	100		300	mV
$I_Q$	Quiescent Current	Output not switching (Note 4)			350	$\mu\text{A}$
$I_S$	Input Supply Current	CTRL pin floating $f = 250\text{kHz}$		1.8	5	mA
$V_{TH}$	Set current Threshold Voltage		95	100	105	mV
$V_{TH-H}$	Set Threshold Hysteresis			$\pm 20$		mV
$I_{SET}$	SET Pin Input Current	$V_{SET} = V_{IN} - 0.1$		16	22	$\mu\text{A}$
$R_{CTRL}$	CTRL Pin Input Resistance	Referred to internal reference		50		k $\Omega$
$V_{REF}$	Internal Reference Voltage			2.5		V
$R_{DS(on)}$	On Resistance of SW MOSFET	$I_{SW} = 1\text{A}$		0.25	0.4	$\Omega$
$t_R$	SW Rise Time	$V_{SENSE} = 100 \pm 20\text{mV}$ , $f_{SW} = 250\text{kHz}$		12		ns
$t_F$	SW Fall Time	$V_{SW} = 0.1\text{V to } 12\text{V to } 0.1\text{V}$ , $C_L = 15\text{pF}$		20		ns
$I_{SW\_Leakage}$	Switch Leakage Current	$V_{IN} = 30\text{V}$			0.5	$\mu\text{A}$
$\theta_{JA}$	Thermal Resistance Junction-to-Ambient (Note 5)	SOT25 (Note 6)		250		$^\circ\text{C/W}$
		MSOP-8EP (Note 7)		69		
$\Psi_{JL}$	Thermal Resistance Junction-to-Lead (Note 8)	SOT25 (Note 6)		50		
$\theta_{JC}$	Thermal Resistance Junction-to-case (Note 9)	MSOP-8EP (Note 7)		4.3		

- Notes:
- AL8807 does not have a low power standby mode but current consumption is reduced when output switch is inhibited:  $V_{SENSE} = 0\text{V}$ . Parameter is tested with  $V_{CTRL} \leq 2.5\text{V}$
  - Refer to figure 35 for the device derating curve.
  - Test condition for SOT25: Device mounted on FR-4 PCB (25mm x 25mm 1oz copper, minimum recommended pad layout on top layer and thermal vias to bottom layer ground plane. For better thermal performance, larger copper pad for heat-sink is needed.
  - Test condition for MSOP-8EP: Device mounted on FR-4 PCB (51mm x 51mm 2oz copper, minimum recommended pad layout on top layer and thermal vias to bottom layer with maximum area ground plane. For better thermal performance, larger copper pad for heat-sink is needed
  - Dominant conduction path via Gnd pin (pin 2).
  - Dominant conduction path via exposed pad.

**Typical Performance Characteristics**

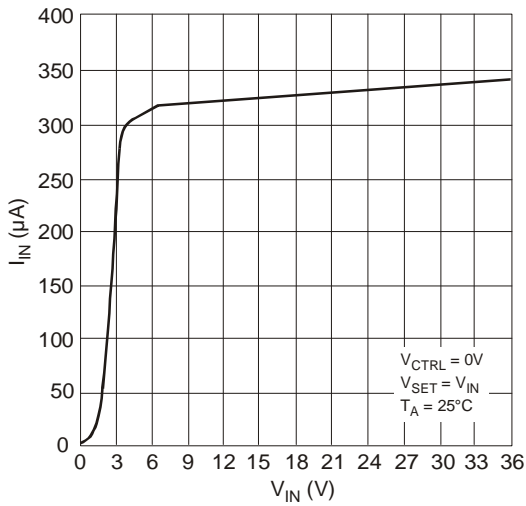

Figure 1. Supply Current (not switching) vs. Input Voltage

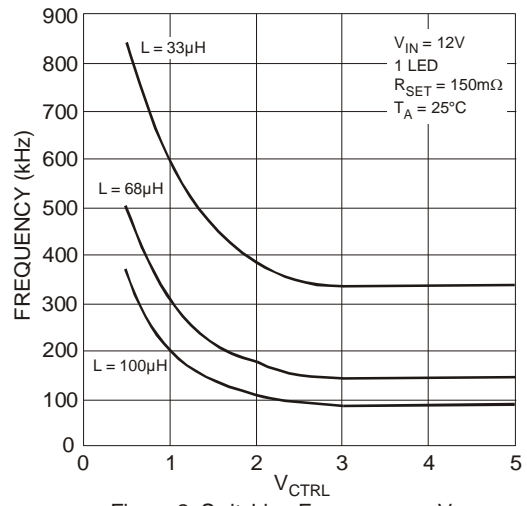

Figure 2. Switching Frequency vs.  $V_{CTRL}$

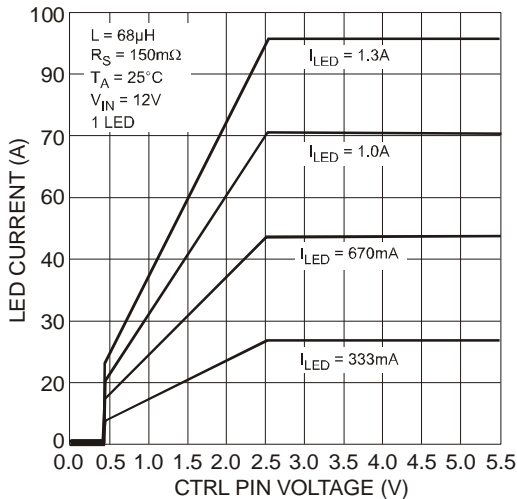

Figure 3. LED Current vs.  $V_{CTRL}$

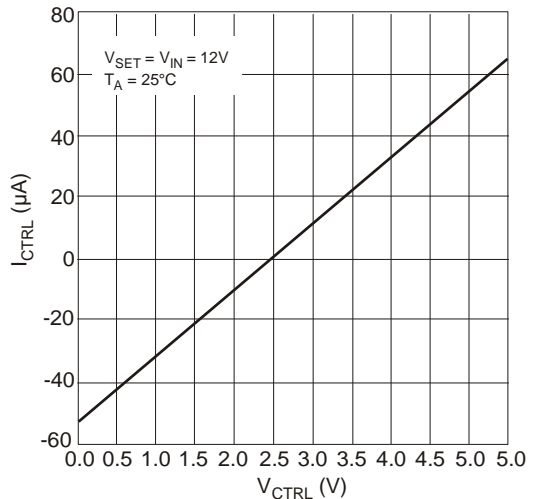

Figure 4.  $I_{CTRL}$  vs.  $V_{CTRL}$

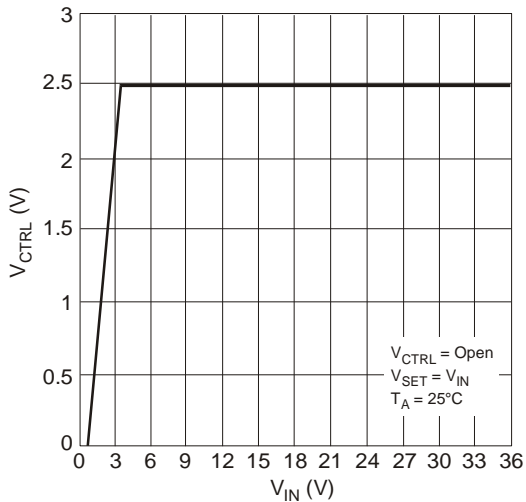

Figure 5.  $V_{CTRL}$  vs. Input Voltage (CTRL Pin Open Circuit)

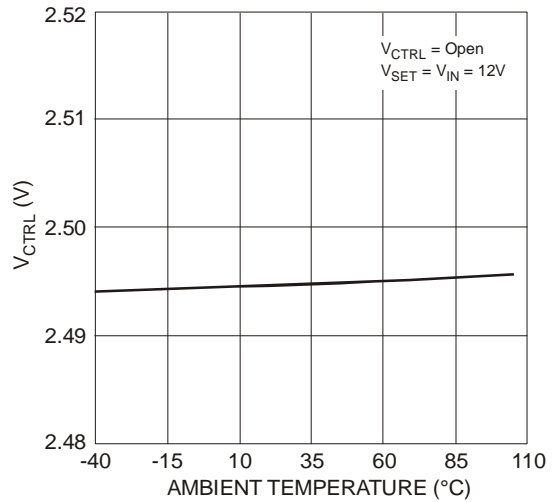

Figure 6.  $V_{CTRL}$  vs. TEMPERATURE

**Typical Performance Characteristics** (cont.)

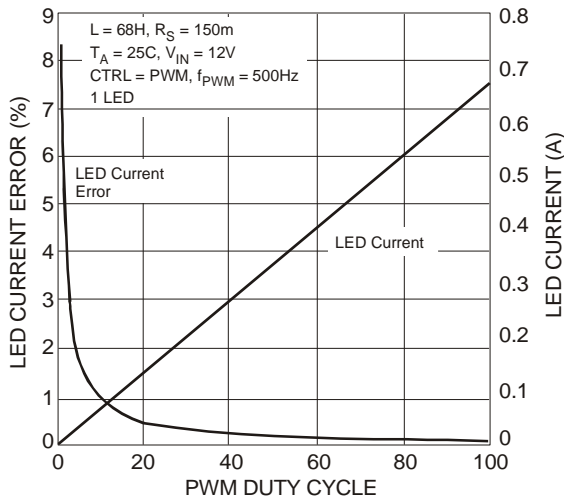

Figure 7.  $I_{LED}$  vs. PWM Duty Cycle

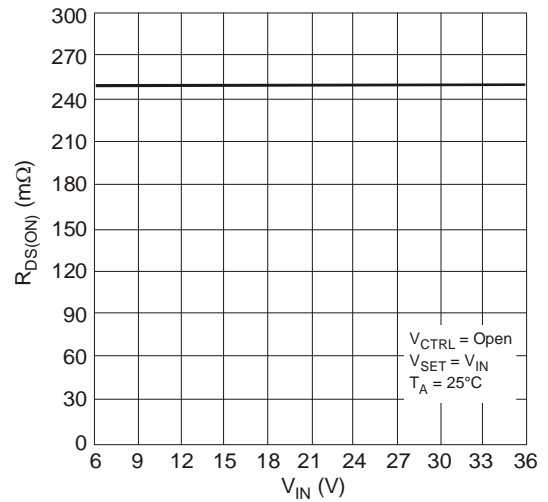

Figure 8. SW  $R_{DS(ON)}$  vs. Input Voltage

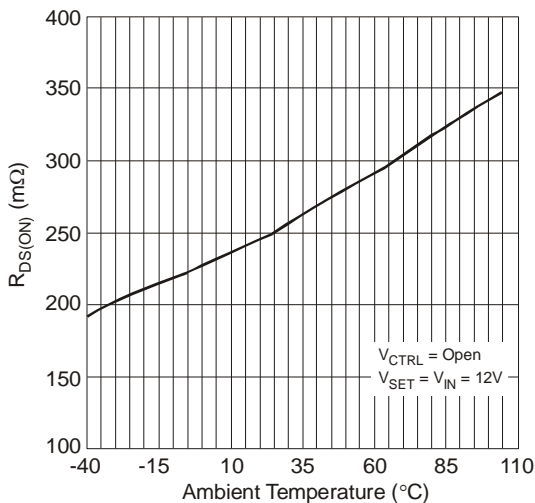

Figure 9. SW  $R_{DS(ON)}$  vs. Temperature

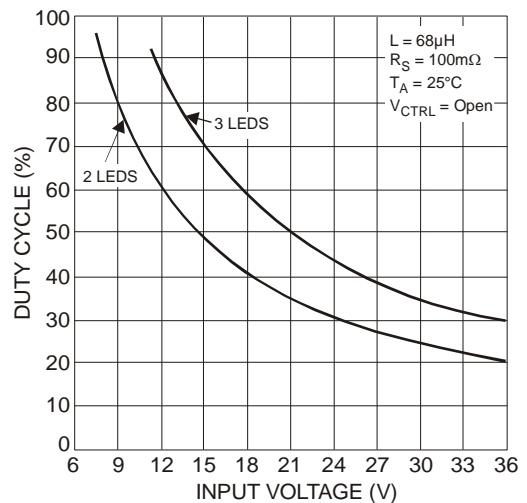

Figure 10. Duty Cycle vs. Input Voltage

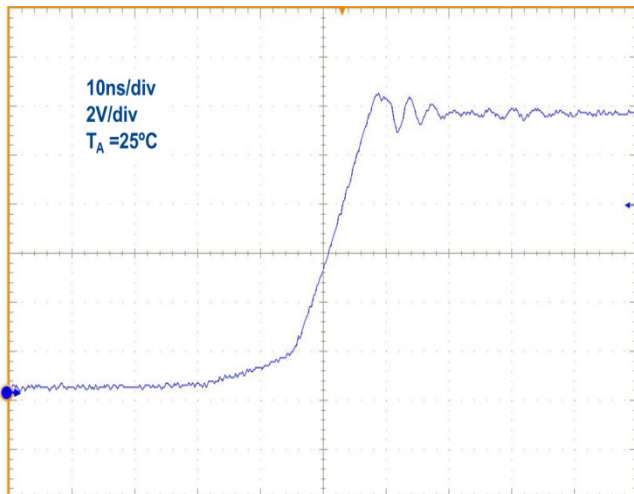

Figure 11. SW Output Rise Time

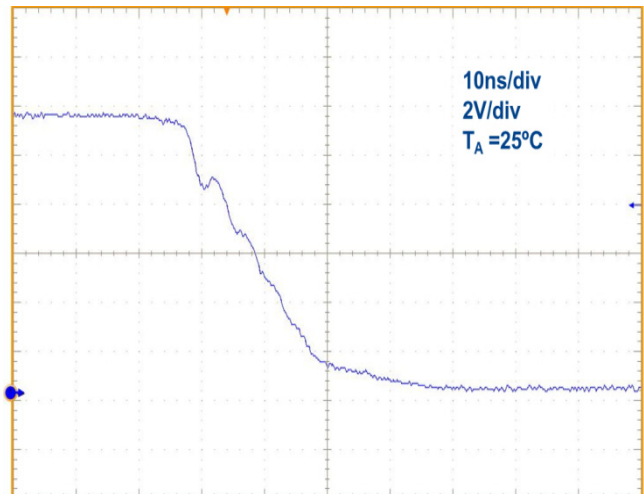

Figure 12. SW Output Fall Time

**Typical Performance Characteristics** (cont.) (670LED Current)

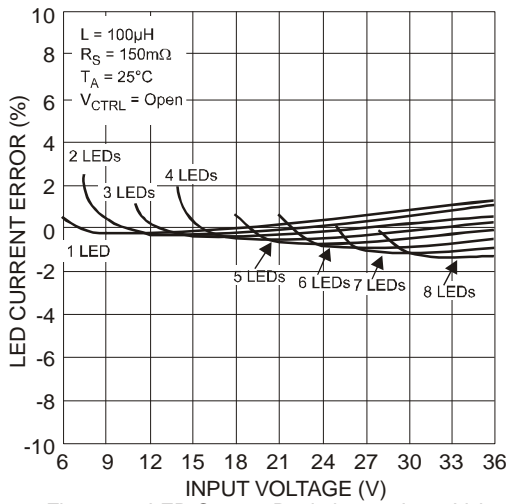

Figure 13. LED Current Deviation vs. Input Voltage

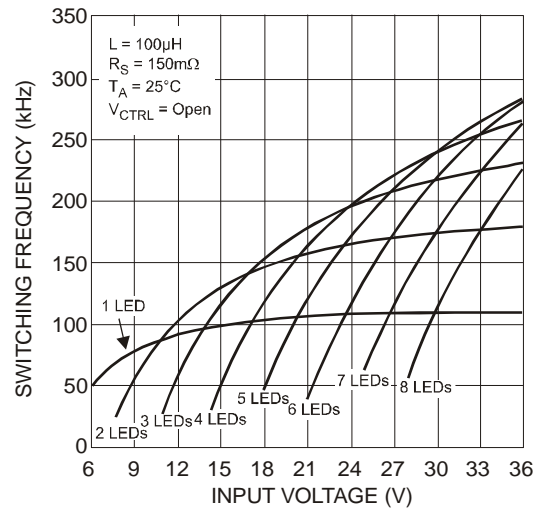

Figure 14. Switching Frequency vs. Input Voltage

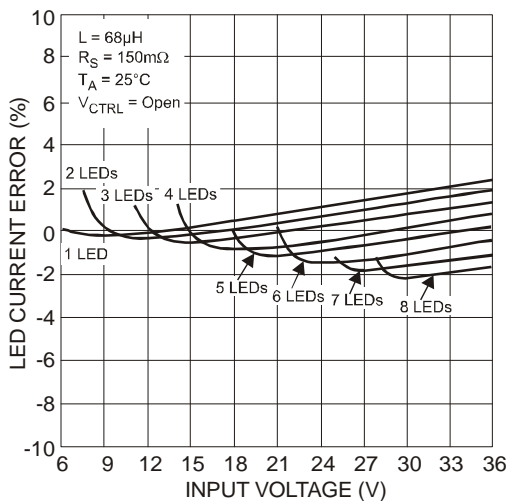

Figure 15. LED Current Deviation vs. Input Voltage

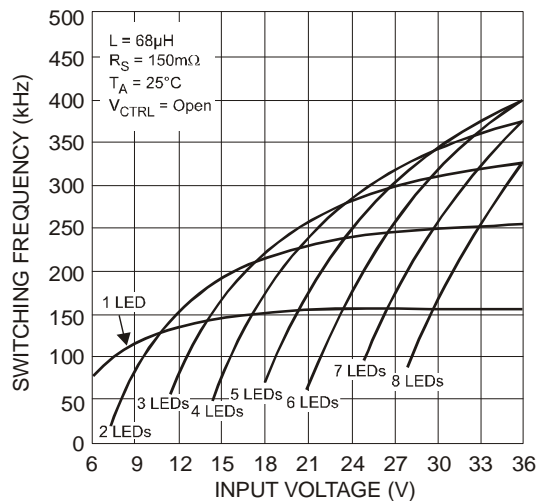

Figure 16. Switching Frequency vs. Input Voltage

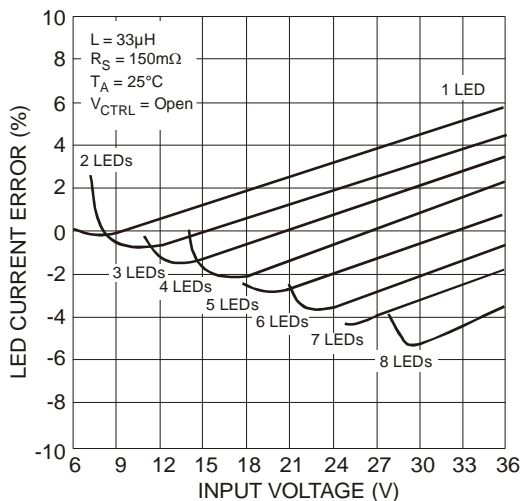

Figure 17. LED Current Deviation vs. Input Voltage

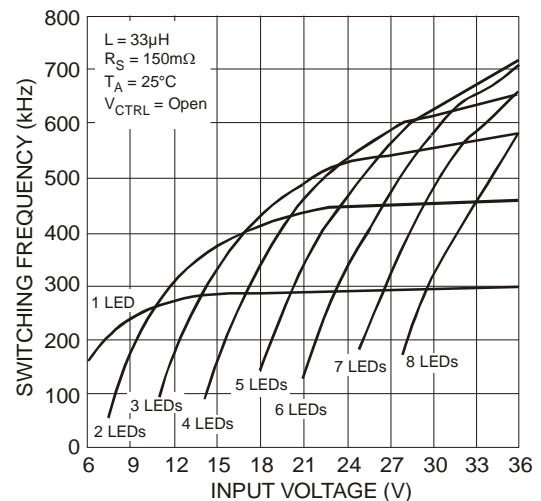

Figure 18. Switching Frequency vs. Input Voltage

**Typical Performance Characteristics** (cont.) (1A LED Current MSOP-8EP)

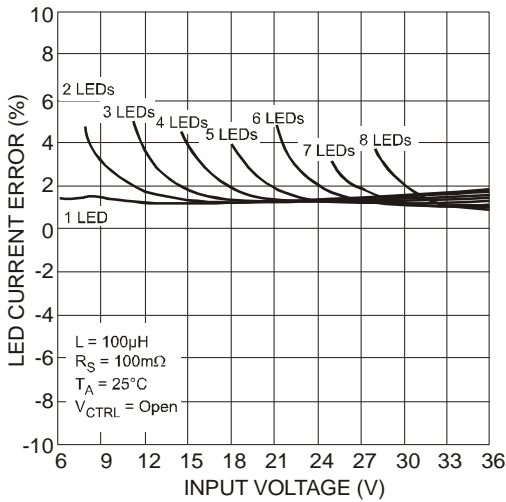

Figure 19. LED Current Deviation vs. Input Voltage

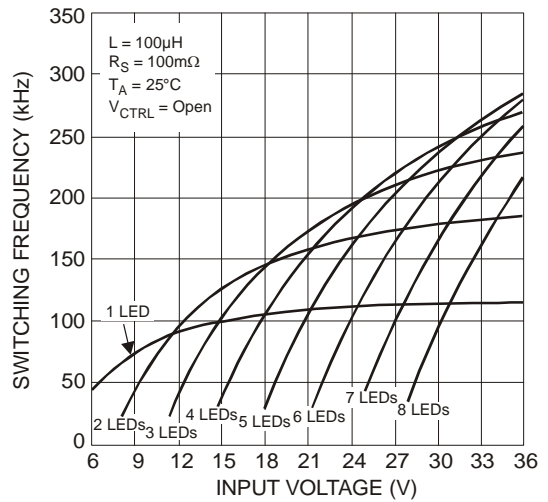

Figure 20. Switching Frequency vs. Input Voltage

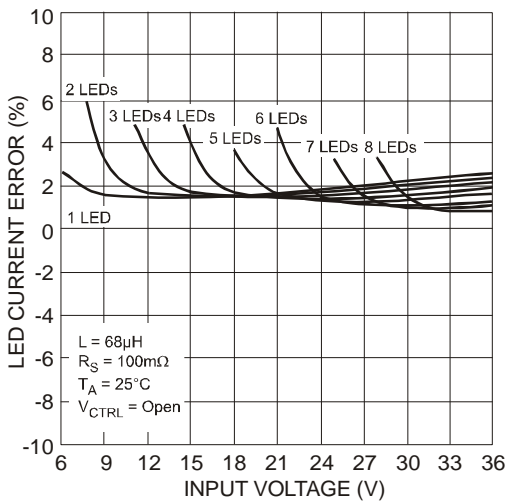

Figure 21. LED Current Deviation vs. Input Voltage

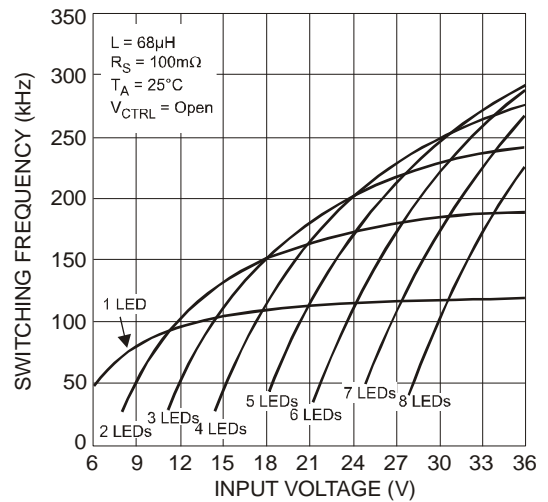

Figure 22. Switching Frequency vs. Input Voltage

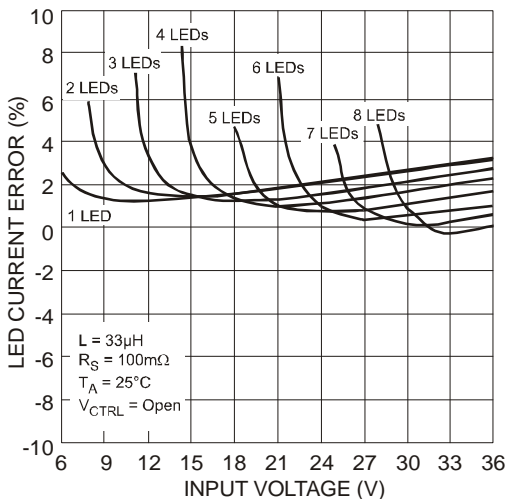

Figure 23. LED Current Deviation vs. Input Voltage

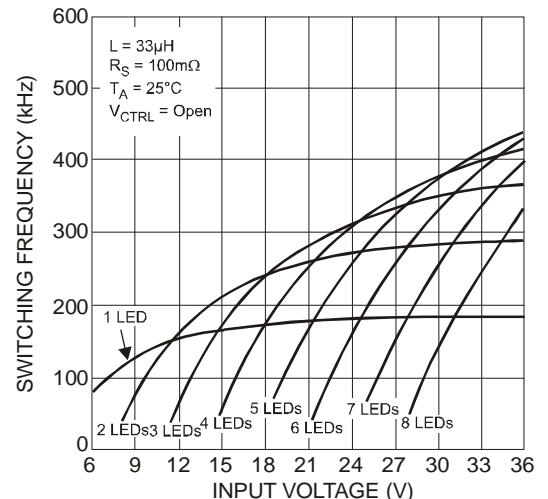

Figure 24. Switching Frequency vs. Input Voltage

**Typical Performance Characteristics (cont.) (1.3A LED Current MSOP-8EP)**

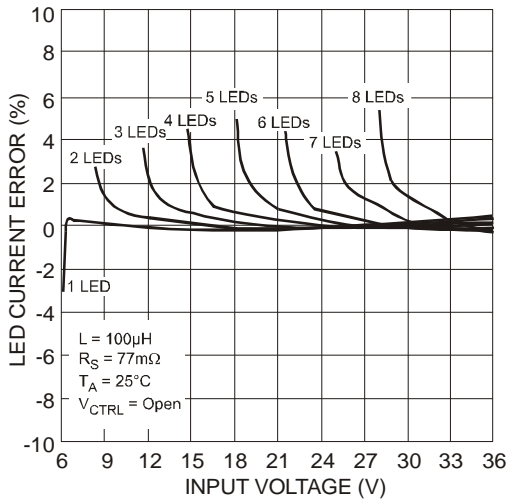

Figure 25. LED Current Deviation vs. Input Voltage

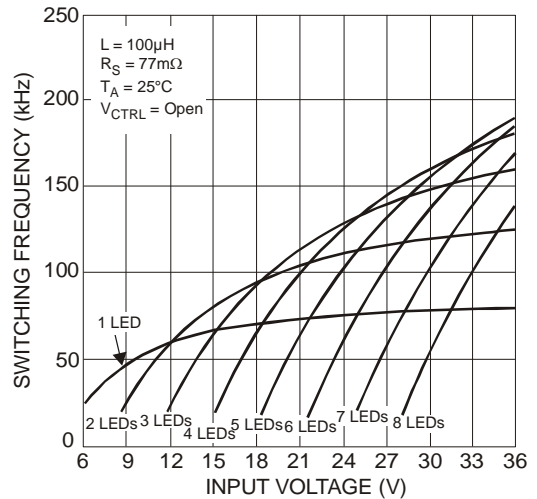

Figure 26. Switching Frequency vs. Input Voltage

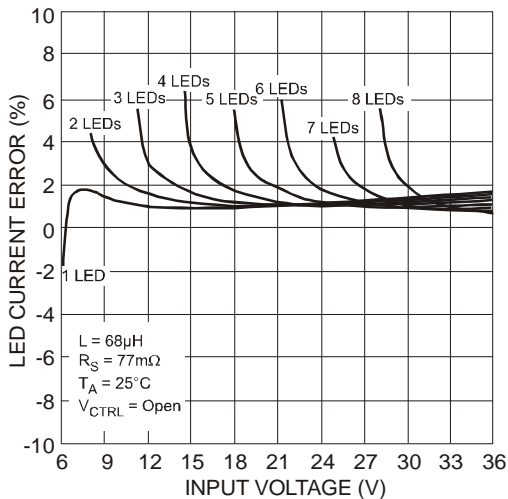

Figure 27. LED Current Deviation vs. Input Voltage

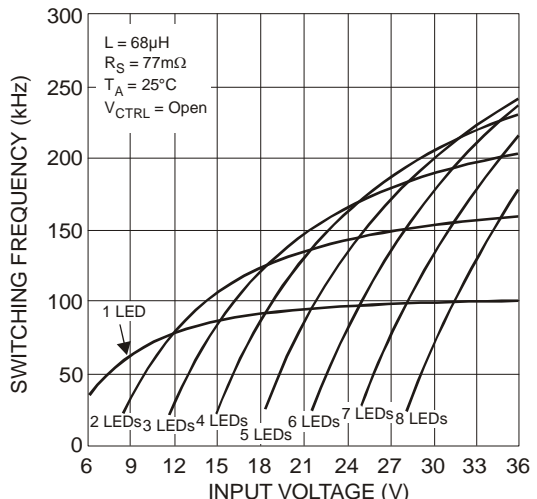

Figure 28. Switching Frequency vs. Input Voltage

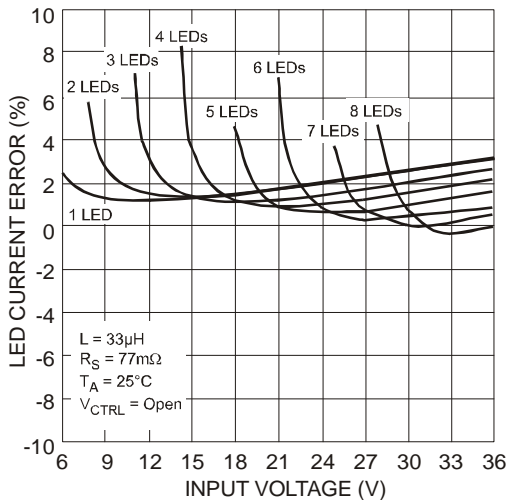

Figure 29. LED Current Deviation vs. Input Voltage

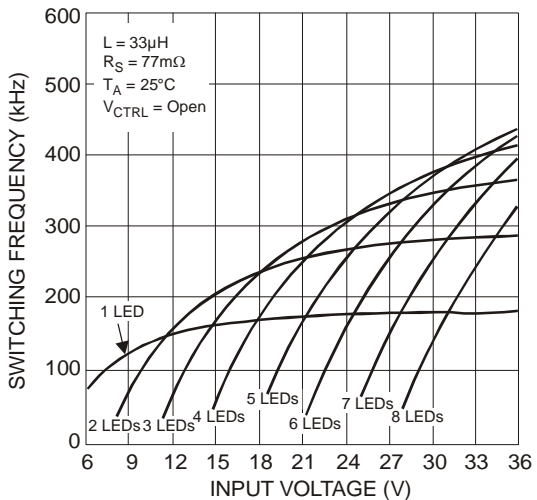

Figure 30. Switching Frequency vs. Input Voltage

## Application Information

The AL8807 is a hysteretic (also known as equal ripple) LED driver with integrated power switch. It is available in two packages that provide a PCB area-power dissipation capability compromise. It is recommended that at higher LED currents/smaller PCBs that the MSOP-8EP version is used to maximize the allowable LED current over a wider ambient temperature range.

### AL8807 Operation

In normal operation, when voltage is applied at +V<sub>IN</sub>, the AL8807 internal switch is turned on. Current starts to flow through sense resistor R<sub>1</sub>, inductor L1, and the LEDs. The current ramps up linearly, and the ramp rate is determined by the input voltage +V<sub>in</sub> and the inductor L1.

This rising current produces a voltage ramp across R<sub>1</sub>. The internal circuit of the AL8807 senses the voltage across R<sub>1</sub> and applies a proportional voltage to the input of the internal comparator.

When this voltage reaches an internally set upper threshold, the internal switch is turned off. The inductor current continues to flow through R<sub>1</sub>, L1, the LEDs and the schottky diode D1, and back to the supply rail, but it decays, with the rate of decay determined by the forward voltage drop of the LEDs and the schottky diode.

This decaying current produces a falling voltage at R<sub>1</sub>, which is sensed by the AL8807. A voltage proportional to the sense voltage across R<sub>1</sub> is applied at the input of the internal comparator. When this voltage falls to the internally set lower threshold, the internal switch is turned on again.

This switch-on-and-off cycle continues to provide the average LED current set by the sense resistor R<sub>1</sub>.

### LED Current Control

The LED current is controlled by the resistor R1 in Figure 30.

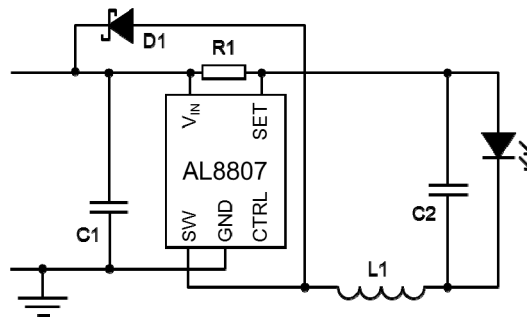

**Figure 30 Typical Application Circuit**

Connected between V<sub>IN</sub> and SET the nominal average output current in the LED(s) is defined as:

$$I_{LED} = \frac{V_{THD}}{R1}$$

For example for a desired LED current of 660mA and a default voltage V<sub>CTRL</sub>=2.5V the resulting resistor is:

$$R1 = \frac{V_{THD}}{I_{LED}} = \frac{0.1}{0.66} \approx 150m\Omega$$

### DC Dimming

Further control of the LED current can be achieved by driving the CTRL pin with an external voltage (between 0.4V and 2.5V); the average LED current becomes:

$$I_{LED} = \frac{V_{CTRL}}{V_{REF}} \frac{V_{THD}}{R_{SET}}$$

With  $0.5V \leq V_{CTRL} \leq 2.5V$  the LED current varies linearly with V<sub>CTRL</sub>, as in figure 2. If the CTRL pin is brought higher than 2.5V, the LED current will be clamped to approximately 100% and follows  $I_{LED} = \frac{V_{THD}}{R_{SET}}$ .

When the CTRL voltage falls below the threshold, 0.4V, the output switch is turned off which allows PWM dimming.

**Application Information** (cont.)

**PWM Dimming**

LED current can be adjusted digitally, by applying a low frequency Pulse Width Modulated (PWM) logic signal to the CTRL pin to turn the device on and off. This will produce an average output current proportional to the duty cycle of the control signal. In particular, a PWM signal with a max resolution of 10bit can be applied to the CTRL pin to change the output current to a value below the nominal average value set by resistor  $R_{SET}$ . To achieve this resolution the PWM frequency has to be lower than 500Hz, however higher dimming frequencies can be used, at the expense of dimming dynamic range and accuracy.

Typically, for a PWM frequency of 500Hz the accuracy is better than 1% for PWM ranging from 1% to 100%.

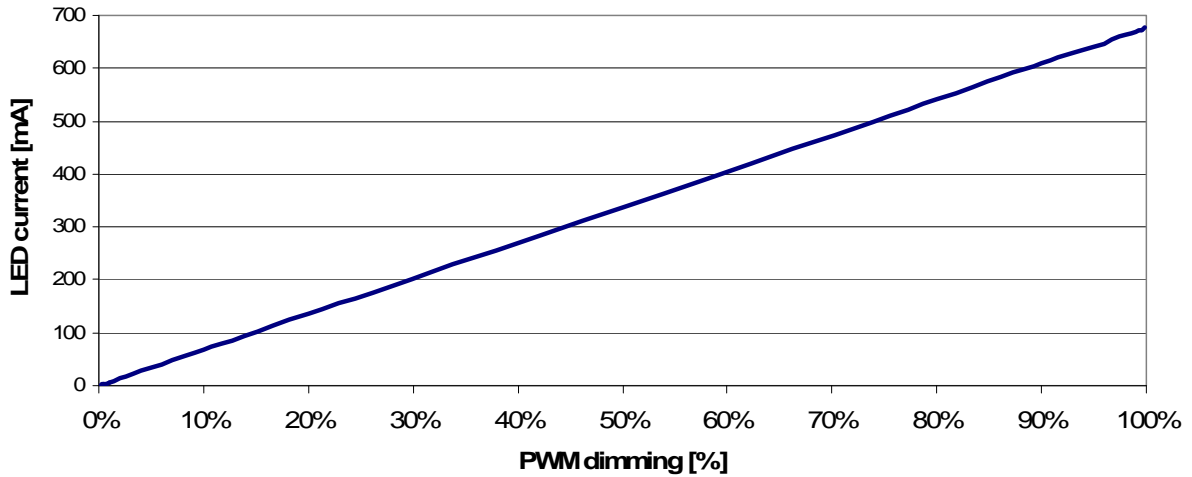

Figure 31 PWM Dimming at 500Hz

Zooming in at duty cycles below 10% shows:

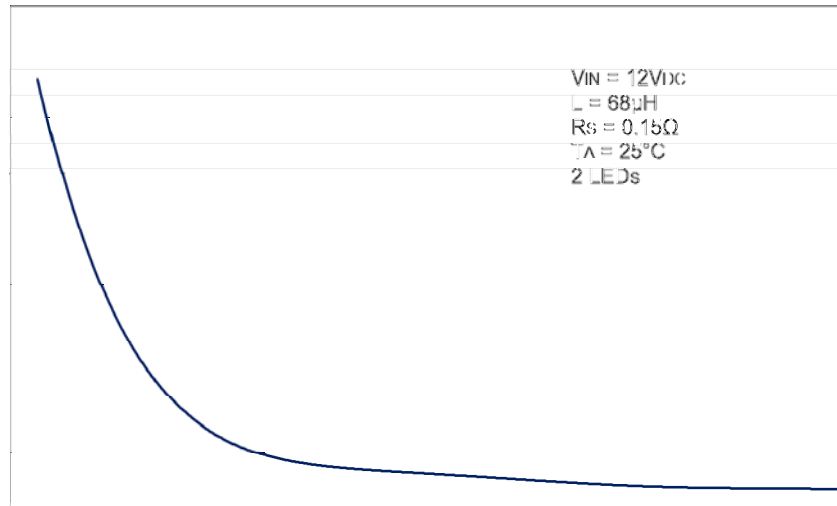

Figure 32 Low Duty Cycle PWM Dimming at 300Hz

The accuracy of the low duty cycle dimming is affected by both the PWM frequency and also the switching frequency of the AL8807. For best accuracy/resolution the switching frequency should be increased while the PWM frequency should be reduced.

The CTRL pin is designed to be driven by both 3.3V and 5V logic levels directly from a logic output with either an open drain output or push pull output stage.

**Application Information** (cont.)

**Soft Start**

The AL8807 does not have in-built soft-start action – this provides very fast turn off of the output the stage improving PWM dimming accuracy; nonetheless, adding an external capacitor from the CTRL pin to ground will provide a soft-start delay. This is achieved by increasing the time taken for the CTRL voltage to rise to the turn-on threshold and by slowing down the rate of rise of the control voltage at the input of the comparator.

Adding a capacitor increases the time taken for the output to reach 90% of its final value, this delay is 0.1ms/nF, but will impact on the PWM dimming accuracy depending on the delay introduced.

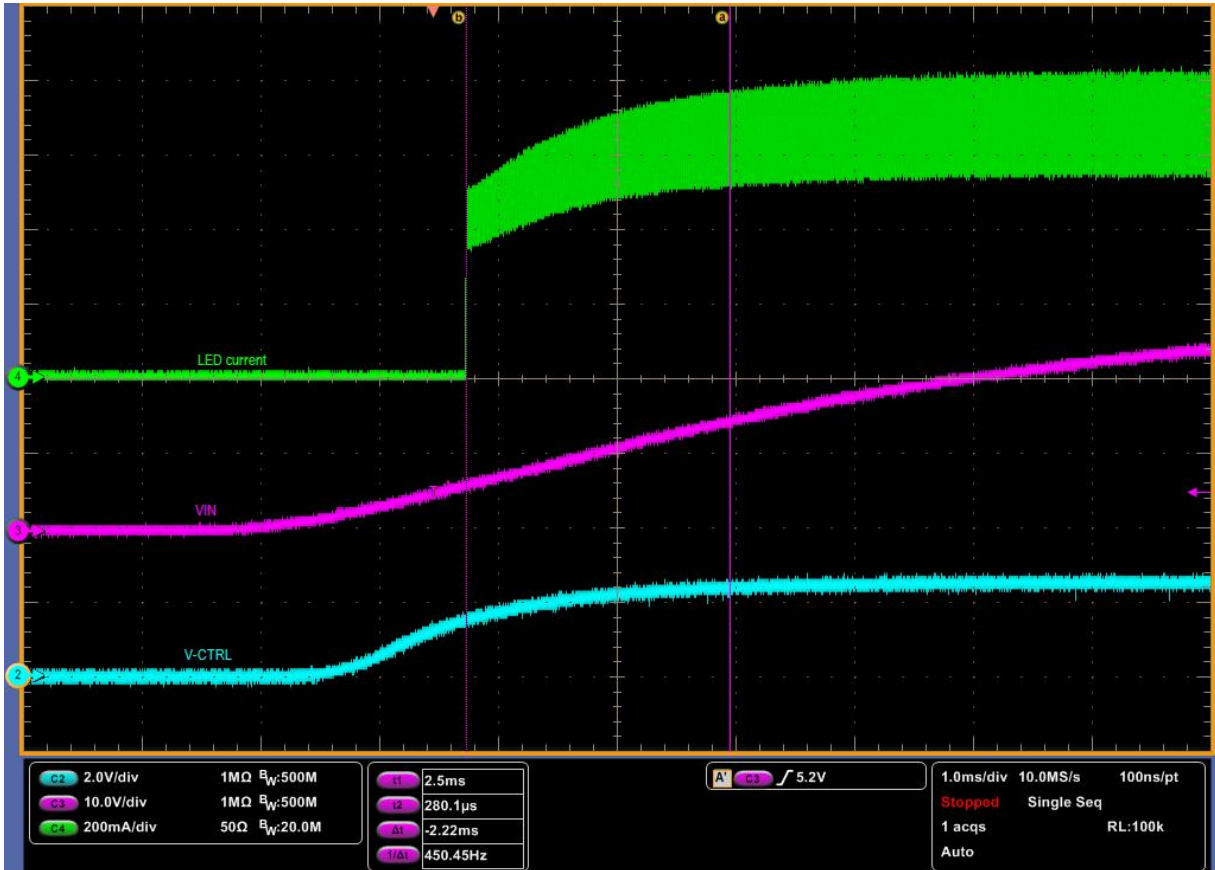

Figure 33 Soft start with 22nF capacitor on CTRL pin ( $V_{IN} = 30V$ ,  $I_{LED} = 667mA$ , 1 LED)

**Reducing Output Ripple**

Peak to peak ripple current in the LED(s) can be reduced, if required, by shunting a capacitor C2 across the LED(s) as shown already in the circuit schematic.

A value of 1 $\mu$ F will reduce the supply ripple current by a factor three (approx.). Proportionally lower ripple can be achieved with higher capacitor values. Note that the capacitor will not affect operating frequency or efficiency, but it will increase start-up delay, by reducing the rate of rise of LED voltage. By adding this capacitor the current waveform through the LED(s) changes from a triangular ramp to a more sinusoidal version without altering the mean current value.

**Capacitor Selection**

The small size of ceramic capacitors makes them ideal for AL8807 applications. X5R and X7R types are recommended because they retain their capacitance over wider voltage and temperature ranges than other types such as Z5U.

A 2.2 $\mu$ F input capacitor is sufficient for most intended applications of AL8807; however a 4.7 $\mu$ F input capacitor is suggested for input voltages approaching 36V.

**Application Information** (cont.)

**Diode Selection**

For maximum efficiency and performance, the rectifier (D1) should be a fast low capacitance Schottky diode with low reverse leakage at the maximum operating voltage and temperature. The Schottky diode also provides better efficiency than silicon PN diodes, due to a combination of lower forward voltage and reduced recovery time.

It is important to select parts with a peak current rating above the peak coil current and a continuous current rating higher than the maximum output load current. In particular, it is recommended to have a diode voltage rating at least 15% higher than the operating voltage to ensure safe operation during the switching and a current rating at least 10% higher than the average diode current. The power rating is verified by calculating the power loss through the diode.

Schottky diodes, e.g. B240 or B140, with their low forward voltage drop and fast reverse recovery, are the ideal choice for AL8807 applications.

**Inductor Selection**

Recommended inductor values for the AL8807 are in the range 33µH to 100µH.

Higher values of inductance are recommended at higher supply voltages in order to minimize errors due to switching delays, which result in increased ripple and lower efficiency. Higher values of inductance also result in a smaller change in output current over the supply voltage range.

(See graphs).

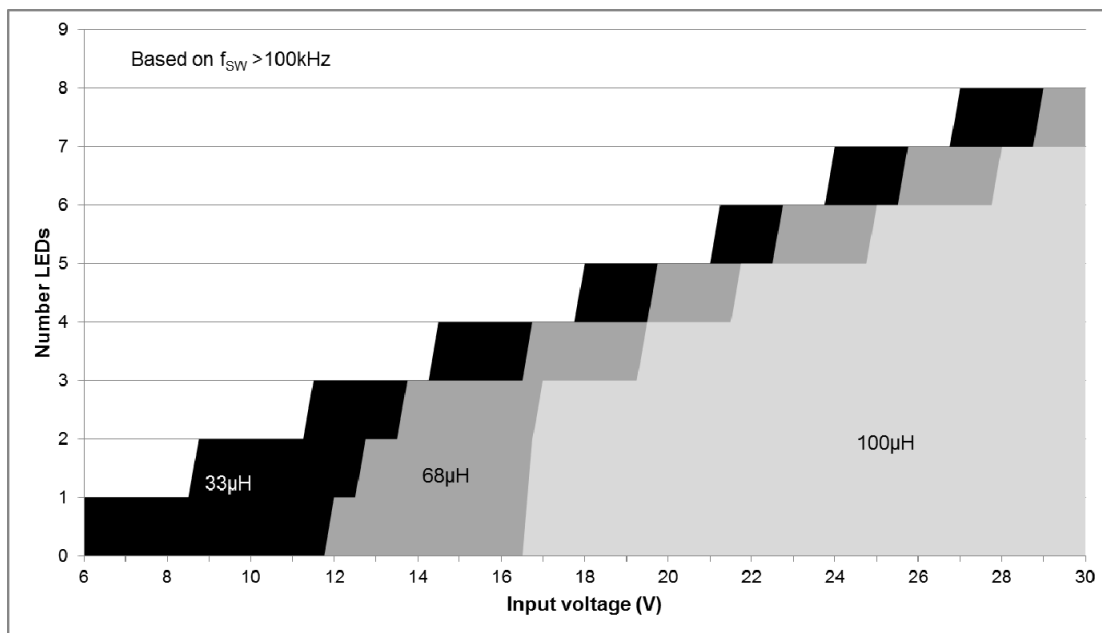

**Figure 34 Inductor value with input voltage and number of LEDs**

The inductor should be mounted as close to the device as possible with low resistance/stray inductance connections to the SW pin.

The chosen coil should have a saturation current higher than the peak output current and a continuous current rating above the required mean output current.

Suitable coils for use with the AL8807 are listed in the table below:

Part No.	L (µH)	DCR (V)	ISAT (A)	Manufacturer
MSS1038-333	33	0.093	2.3	CoilCraft <a href="http://www.coilcraft.com">www.coilcraft.com</a>
MSS1038-683	68	0.213	1.5	
NPIS64D330MTRF	33	0.124	1.1	NIC <a href="http://www.niccomp.com">www.niccomp.com</a>

The inductor value should be chosen to maintain operating duty cycle and switch 'on'/off times over the supply voltage and load current range.

**Application Information** (cont.)

The following equations can be used as a guide, with reference to Figure 1 - Operating waveforms.

$$t_{ON} = \frac{\text{Switch 'On' time } L\Delta I}{V_{IN} - V_{LED} - I_{AVG} \times (R_S + r_L + R_{SW})}$$

$$t_{OFF} = \frac{\text{Switch 'Off' time } L\Delta I}{V_{LED} + V_D + I_{AVG} \times (R_S + r_L)}$$

Where:

- L is the coil inductance (H)
- r<sub>L</sub> is the coil resistance (Ω) R<sub>S</sub> is the current sense resistance (Ω)
- I<sub>avg</sub> is the required LED current (A)
- ΔI is the coil peak-peak ripple current (A) {Internally set to 0.3 x I<sub>avg</sub>}
- V<sub>IN</sub> is the supply voltage (V)
- V<sub>LED</sub> is the total LED forward voltage (V)
- R<sub>SW</sub> is the switch resistance (Ω) {=0.5Ω nominal}
- V<sub>D</sub> is the diode forward voltage at the required load current (V)

**Thermal Considerations**

For continuous conduction mode of operation, the absolute maximum junction temperature must not be exceeded. The maximum power dissipation depends on several factors: the thermal resistance of the IC package θ<sub>JA</sub>, PCB layout, airflow surrounding the IC, and difference between junction and ambient temperature.

The maximum power dissipation can be calculated using the following formula:

$$P_{D(MAX)} = (T_{J(MAX)} - T_A) / \theta_{JA}$$

where

- T<sub>J(MAX)</sub> is the maximum operating junction temperature,
- T<sub>A</sub> is the ambient temperature, and
- θ<sub>JA</sub> is the junction to ambient thermal resistance.

The recommended maximum operating junction temperature, T<sub>J</sub>, is 125°C and so maximum ambient temperature is determined by the AL8807's junction to ambient thermal resistance, θ<sub>JA</sub> and device power dissipation.

θ<sub>JA</sub>, is layout dependent and package dependent; the AL8807W5's θ<sub>JA</sub> on a 25x25mm single layer PCB with 1oz copper standing in still air is approximately 250°C/W (160°C/W on a four-layer PCB).

The maximum power dissipation at T<sub>A</sub> = 25°C can be calculated by the following formulas:

$$P_{D(MAX)} = (125^\circ\text{C} - 25^\circ\text{C}) / (250^\circ\text{C/W}) = 0.4\text{W for single-layer PCB}$$

$$P_{D(MAX)} = (125^\circ\text{C} - 25^\circ\text{C}) / (160^\circ\text{C/W}) = 0.625\text{W for standard four-layer PCB}$$

Figure 35, shows the power derating of the AL8807W5 on two (one single-layer and four-layer) different 25x25mm PCB with 1oz copper standing in still air and the AL8807MP on an FR4 51x51mm PCB with 2oz copper standing in still air.

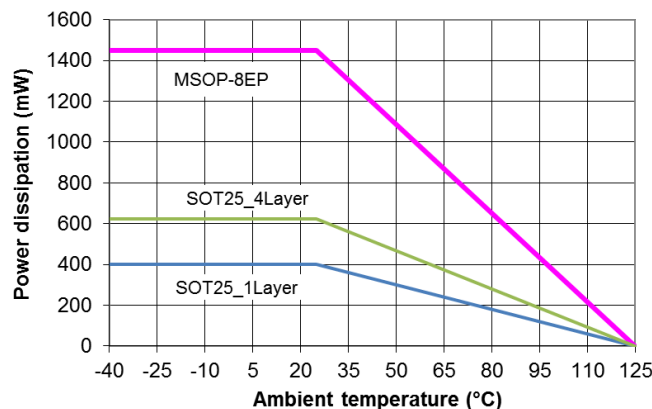
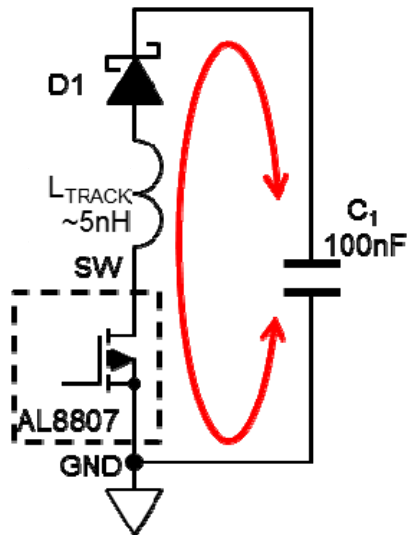

**Figure 35 Derating Curve for Different PCB**

**Application Information** (cont.)

**EMI and Layout Considerations**

The AL8807 is a switching regulator with fast edges and measures small differential voltages; as a result of this care has to be taken with decoupling and layout of the PCB. To help with these effects the AL8807 has been developed to minimise radiated emissions by controlling the switching speeds of the internal power MOSFET. The rise and fall times are controlled to get the right compromise between power dissipation due to switching losses and radiated EMI. The turn-on edge (falling edge) dominates the radiated EMI which is due to an interaction between the Schottky diode (D1), Switching MOSFET and PCB tracks. After the Schottky diode reverse recovery time of around 5ns has occurred; the falling edge of the SW pin sees a resonant loop between the Schottky diode capacitance and the track inductance,  $L_{TRACK}$ , See figure 36.



**Figure 36 PCB Loop Resonance**

The tracks from the SW pin to the Anode of the Schottky diode, D1, and then from D1's cathode to the decoupling capacitors C1 should be as short as possible. There is an inductance internally in the AL8807 this can be assumed to be around 1nH. For PCB tracks a figure of 0.5nH per mm can be used to estimate the primary resonant frequency. If the track is capable of handling 1A increasing the thickness will have a minor effect on the inductance and length will dominate the size of the inductance. The resonant frequency of any oscillation is determined by the combined inductance in the track and the effective capacitance of the Schottky diode. An example of good layout is shown in figure 37 - the stray track inductance should be less than 5nH.

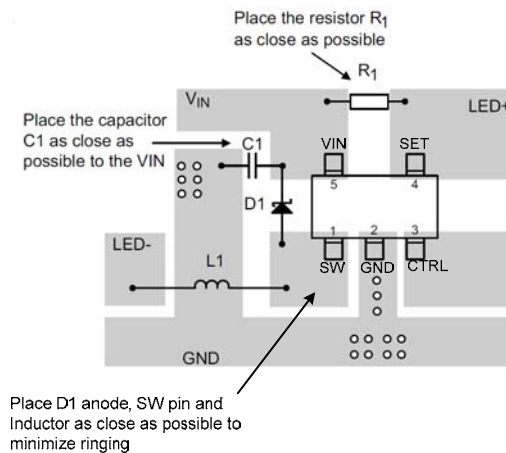

**Figure 37 Recommended PCB Layout**

**Application Information** (cont.)

Recommendations for minimising radiated EMI and other transients and thermal considerations are:

1. The decoupling capacitor (C1) has to be placed as close as possible to the V<sub>IN</sub> pin and D1 Cathode
2. The freewheeling diode's (D1) anode, the SW pin and the inductor have to be placed as close as possible to each other to avoid ringing.
3. The Ground return path from C1 must be a low impedance path with the ground plane as large as possible
4. The LED current sense resistor (R1) has to be placed as close as possible to the V<sub>IN</sub> and SET pins.
5. The majority of the conducted heat from the AL8807 is through the GND pin 2. A maximum earth plane with thermal vias into a second earth plane will minimise self-heating
6. To reduce emissions via long leads on the supply input and LEDs low RF impedance capacitors (C2 and C5) should be used at the point the wires are joined to the PCB

A typical application for the AL8807 is an LED MR16 lamp (schematic shown in Figure 38).

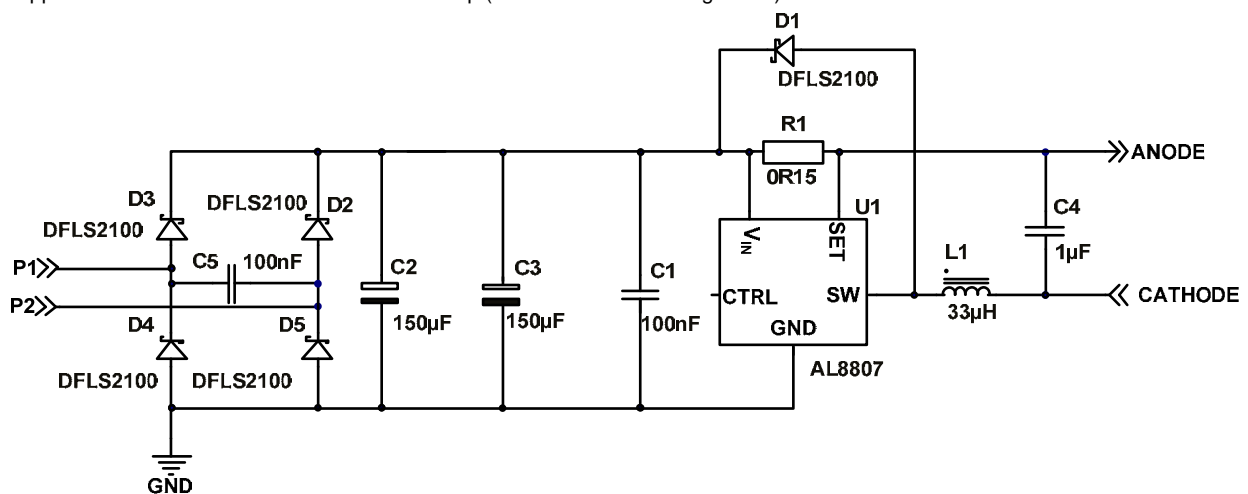

**Figure 38 MR16 Circuit Schematic**

An evaluation board for the AL8807 (named the AL8807EV2) for MR16 is available on request from your local Diodes' sales representative. This board follows Diodes' recommendations for low EMI. Images of the top layer and bottom layers are shown in Figure 39.

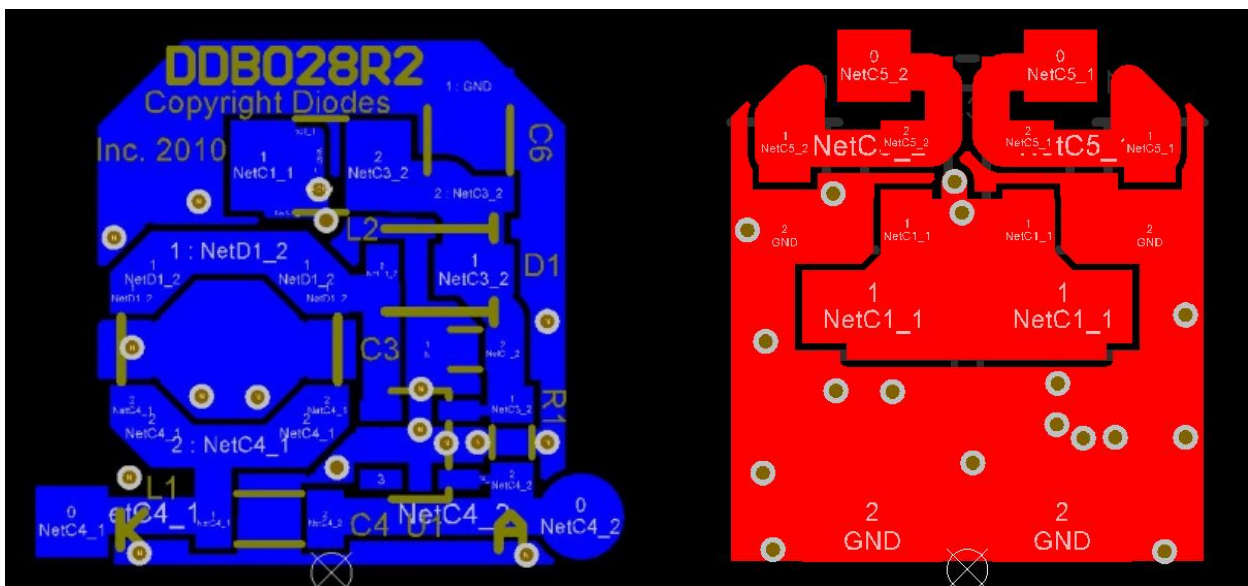

**Figure 39 Recommended MR16 PCB Layout**

**Application Information** (cont.)

The associated EMI measurements for this board using the AL8807 is shown in figure 40.

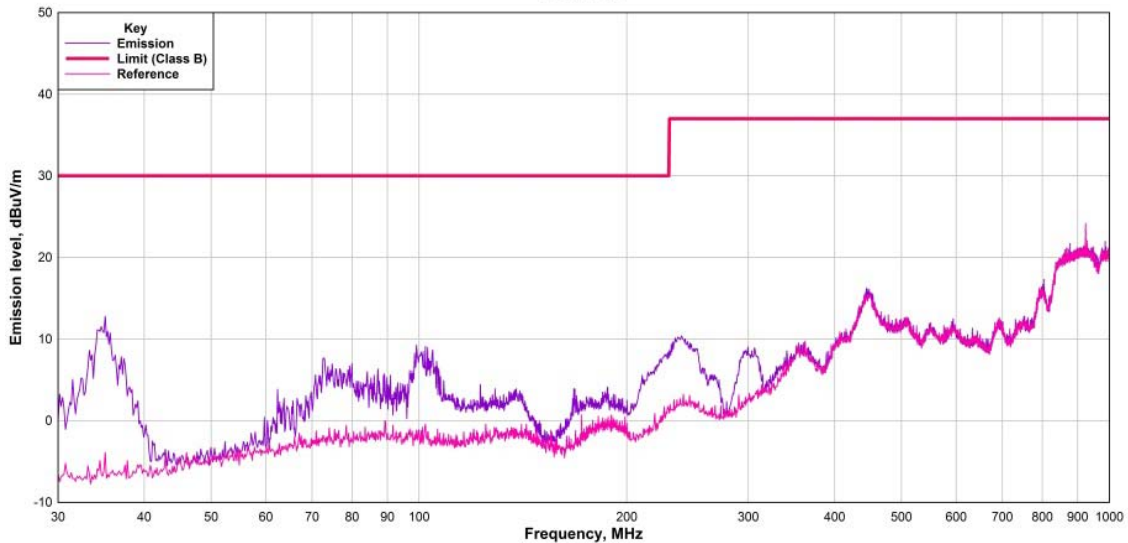
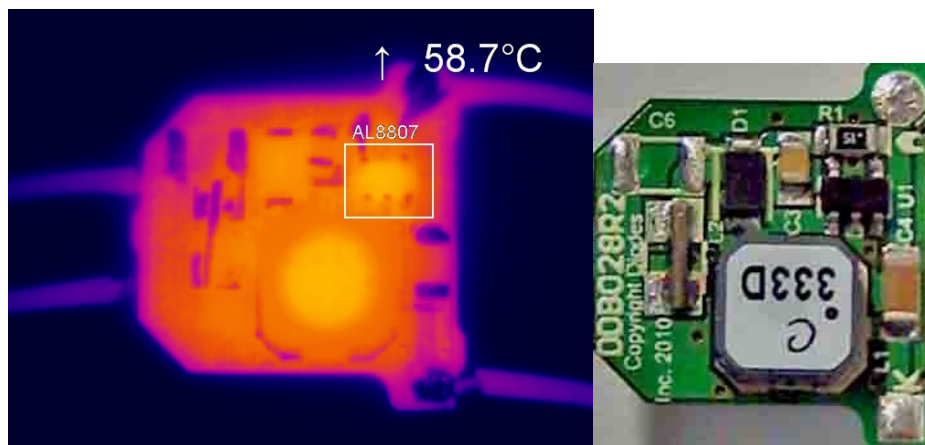

**Figure 40 AL8807EV2 Radiated EMI Performance**

The EMI performance was measured at 12V<sub>DC</sub> driving two white LEDs ( $V_F = 3.1V$  at 660mA) on the AL8807EV2. The red bold line is for EN55022 class B used for domestic equipment including lighting. The bottom magenta line is the noise floor of the test chamber. The middle purple line is the EMI emitted radiation of the AL8807 over 30MHz to 1000MHz. This shows that the AL8807 passes the standard with at least 16dB margin.

MR16 lamps typically operate from 12V<sub>DC</sub> or 12V<sub>AC</sub>, using conventional electromagnetic transformers or electronic transformers.

In enclosed lamps such MR16 the ability for the device to operate at high ambient temperatures is critical and figure 41 shows the surface temperature of the AL8807 on AL8807EV2 in operation under the same conditions as the EMI tests at an free air temperature of 25°C. It is anticipated that the internal junction temperature is approximately 6°C hotter than the surface temperature.



**Figure 41 Thermal picture of AL8807EV2 at 12V<sub>DC</sub> 2 white LEDs at 660mA**

The thermal image shows that components increasing the board temperature are the inductor, Schottky diodes and the AL8807.

An inductor choice of 33μH with saturation current higher than 1.1A, will limit the frequency variation between 180kHz and 400kHz over the whole input voltage variation (8V to 18V), and therefore represent the best choice for an MR16 solution also taking into account the size constraint of the lamp.

The AL8807 guarantees high performance levels with both 12V<sub>AC</sub> and 12V<sub>DC</sub> power supplies.

The efficiency is generally higher than 81% and current regulation is better than 0.1mA/V in for a DC input voltage in the range from 8V to 18V.

## Ordering Information

### AL8807 XX - XX

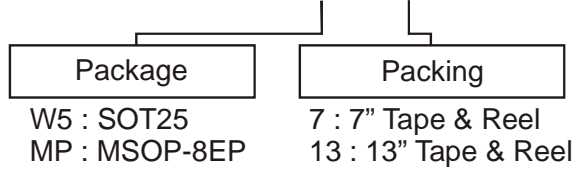

Part Number	Status	Package Code	Packaging	7" Tape and Reel	
				Quantity	Part Number Suffix
AL8807W5-7	New Product	W5	SOT25	3000/Tape & Reel	-7
AL8807MP-13	New Product	MP	MSOP-8EP	2500/Tape & Reel	-13

## Marking Information

### (1) SOT25

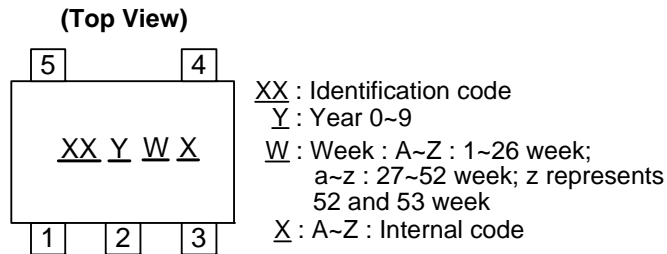

Part Number	Package	Identification Code
AL8807W5-7	SOT25	B6

### (2) MSOP-8EP

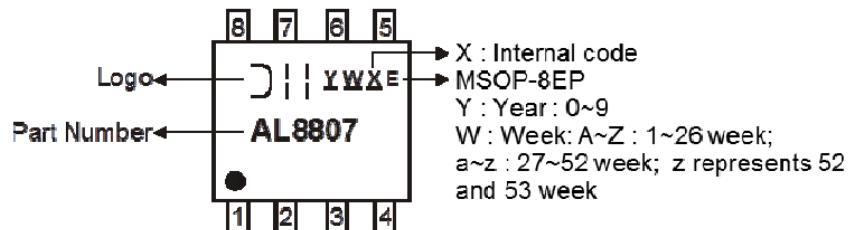

Part Number	Package
AL8807MP-13	MSOP-8EP

**Package Outline Dimensions** (All dimensions in mm.)

Please see AP02002 at <http://www.diodes.com/datasheets/ap02002.pdf> for latest version.

(1) SOT25

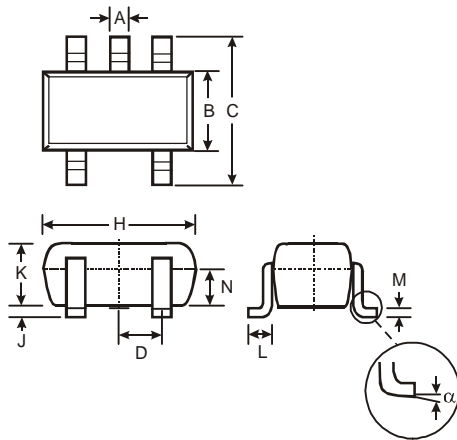

SOT25			
Dim	Min	Max	Typ
A	0.35	0.50	0.38
B	1.50	1.70	1.60
C	2.70	3.00	2.80
D	—	—	0.95
H	2.90	3.10	3.00
J	0.013	0.10	0.05
K	1.00	1.30	1.10
L	0.35	0.55	0.40
M	0.10	0.20	0.15
N	0.70	0.80	0.75
α	0°	8°	—
All Dimensions in mm			

(2) MSOP-8EP

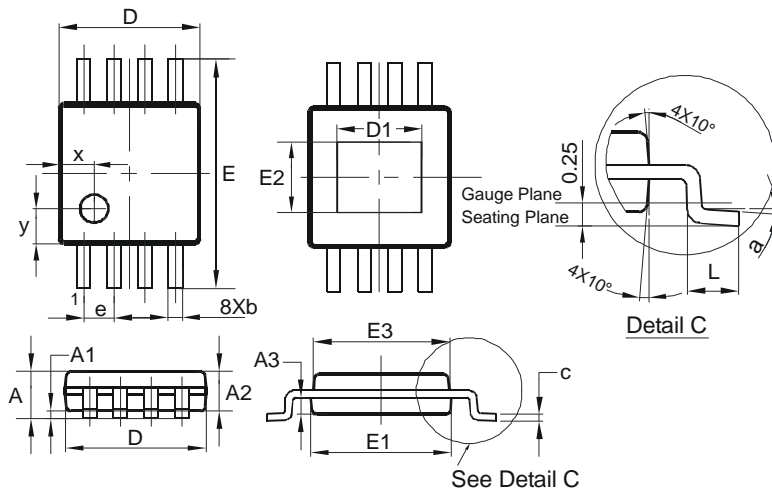

MSOP-8EP			
Dim	Min	Max	Typ
A	-	1.10	-
A1	0.05	0.15	0.10
A2	0.75	0.95	0.86
A3	0.29	0.49	0.39
b	0.22	0.38	0.30
c	0.08	0.23	0.15
D	2.90	3.10	3.00
D1	1.60	2.00	1.80
E	4.70	5.10	4.90
E1	2.90	3.10	3.00
E2	1.30	1.70	1.50
E3	2.85	3.05	2.95
e	-	-	0.65
L	0.40	0.80	0.60
a	0°	8°	4°
x	-	-	0.750
y	-	-	0.750
All Dimensions in mm			

## Suggested Pad Layout

Please see AP02001 at <http://www.diodes.com/datasheets/ap02001.pdf> for the latest version.

(1) SOT25

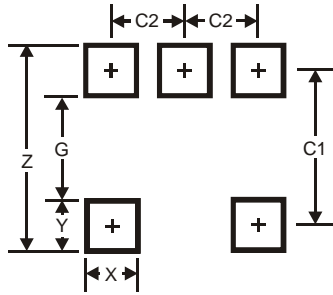

Dimensions	Value (in mm)
Z	3.20
G	1.60
X	0.55
Y	0.80
C1	2.40
C2	0.95

(2) MSOP-8EP

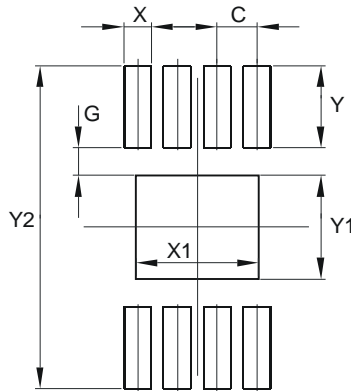

Dimensions	Value (in mm)
C	0.650
G	0.450
X	0.450
X1	2.000
Y	1.350
Y1	1.700
Y2	5.300

**IMPORTANT NOTICE**

DIODES INCORPORATED MAKES NO WARRANTY OF ANY KIND, EXPRESS OR IMPLIED, WITH REGARDS TO THIS DOCUMENT, INCLUDING, BUT NOT LIMITED TO, THE IMPLIED WARRANTIES OF MERCHANTABILITY AND FITNESS FOR A PARTICULAR PURPOSE (AND THEIR EQUIVALENTS UNDER THE LAWS OF ANY JURISDICTION).

Diodes Incorporated and its subsidiaries reserve the right to make modifications, enhancements, improvements, corrections or other changes without further notice to this document and any product described herein. Diodes Incorporated does not assume any liability arising out of the application or use of this document or any product described herein; neither does Diodes Incorporated convey any license under its patent or trademark rights, nor the rights of others. Any Customer or user of this document or products described herein in such applications shall assume all risks of such use and will agree to hold Diodes Incorporated and all the companies whose products are represented on Diodes Incorporated website, harmless against all damages.

Diodes Incorporated does not warrant or accept any liability whatsoever in respect of any products purchased through unauthorized sales channel. Should Customers purchase or use Diodes Incorporated products for any unintended or unauthorized application, Customers shall indemnify and hold Diodes Incorporated and its representatives harmless against all claims, damages, expenses, and attorney fees arising out of, directly or indirectly, any claim of personal injury or death associated with such unintended or unauthorized application.

Products described herein may be covered by one or more United States, international or foreign patents pending. Product names and markings noted herein may also be covered by one or more United States, international or foreign trademarks.

This document is written in English but may be translated into multiple languages for reference. Only the English version of this document is the final and determinative format released by Diodes Incorporated.

**LIFE SUPPORT**

Diodes Incorporated products are specifically not authorized for use as critical components in life support devices or systems without the express written approval of the Chief Executive Officer of Diodes Incorporated. As used herein:

A. Life support devices or systems are devices or systems which:

1. are intended to implant into the body, or
2. support or sustain life and whose failure to perform when properly used in accordance with instructions for use provided in the labeling can be reasonably expected to result in significant injury to the user.

B. A critical component is any component in a life support device or system whose failure to perform can be reasonably expected to cause the failure of the life support device or to affect its safety or effectiveness.

Customers represent that they have all necessary expertise in the safety and regulatory ramifications of their life support devices or systems, and acknowledge and agree that they are solely responsible for all legal, regulatory and safety-related requirements concerning their products and any use of Diodes Incorporated products in such safety-critical, life support devices or systems, notwithstanding any devices- or systems-related information or support that may be provided by Diodes Incorporated. Further, Customers must fully indemnify Diodes Incorporated and its representatives against any damages arising out of the use of Diodes Incorporated products in such safety-critical, life support devices or systems.

Copyright © 2013, Diodes Incorporated

[www.diodes.com](http://www.diodes.com)

## Looking for pricing, stock, or lifecycle information?

Click below to explore more details on WIN SOURCE:

 [View AL8807EV3 on WIN SOURCE](#)

 [Diodes Incorporated](#) Information

## Optimize Your Supply Chain with WIN SOURCE Solutions

-  Global Sourcing Solution
-  Obsolete Management
-  Cost Control Management
-  Shortage Management
-  Alternative Solution
-  Excess Inventory Management