

# AN79Lxx/AN79LxxM Series

## 3-pin negative output voltage regulator (100 mA type)

### ■ Overview

The AN79Lxx series and the AN79LxxM series are 3-pin, fixed negative output type monolithic voltage regulators.

Stabilized fixed output voltage is obtained from unstable DC input voltage without using any external components. 12 types of output voltage are available:  $-4\text{V}$ ,  $-5\text{V}$ ,  $-6\text{V}$ ,  $-7\text{V}$ ,  $-8\text{V}$ ,  $-9\text{V}$ ,  $-10\text{V}$ ,  $-12\text{V}$ ,  $-15\text{V}$ ,  $-18\text{V}$ ,  $-20\text{V}$  and  $-24\text{V}$ . They can be used widely in power circuits with current capacity of up to 100mA.

### ■ Features

- No external components
- Output voltage:  $-4\text{V}$ ,  $-5\text{V}$ ,  $-6\text{V}$ ,  $-7\text{V}$ ,  $-8\text{V}$ ,  $-9\text{V}$ ,  $-10\text{V}$ ,  $-12\text{V}$ ,  $-15\text{V}$ ,  $-18\text{V}$ ,  $-20\text{V}$ ,  $-24\text{V}$
- Built-in overcurrent limit circuit
- Built-in thermal overload protection circuit

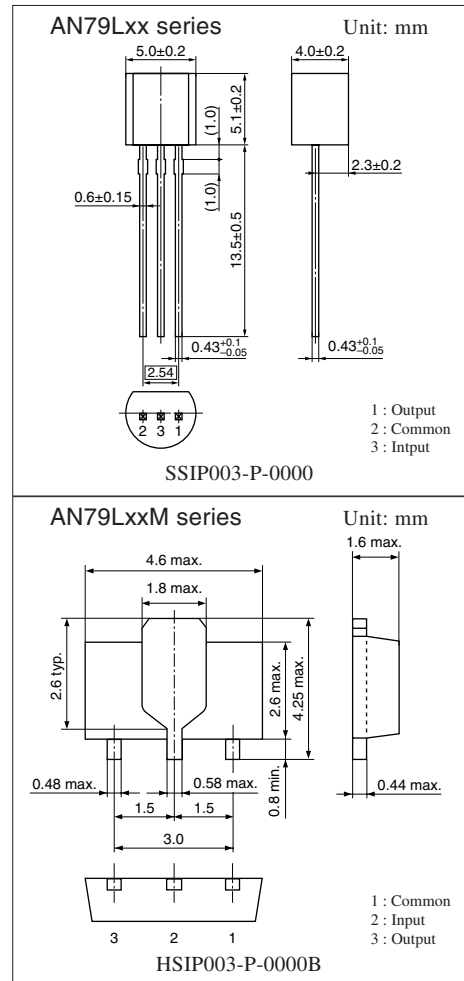

### ■ Block Diagram (AN79Lxx series)

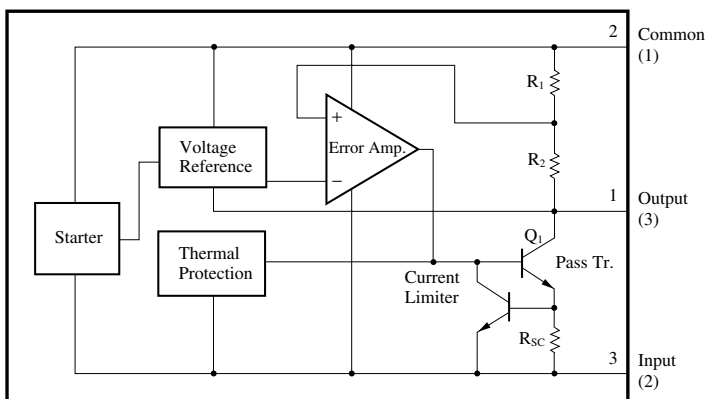

Note) The number in ( ) shows the pin number for the AN79LxxM series.

Note) The packages (SSIP003-P-0000 and HSIP003-P-0000B) of this product will be changed to lead-free type (SSIP003-P-0000S and HSIP003-P-0000Q). See the new package dimensions section later of this datasheet.

### ■ Absolute Maximum Ratings at $T_a = 25^\circ\text{C}$

Parameter		Symbol	Rating	Unit
Input voltage		$V_I$	-35 <sup>*1</sup>	V
			-40 <sup>*2</sup>	V
Power dissipation		$P_D$	650 <sup>*3</sup>	mW
Operating ambient temperature		$T_{opr}$	-20 to +80	$^\circ\text{C}$
Storage temperature	AN79Lxx series	$T_{stg}$	-55 to +150	$^\circ\text{C}$
	AN79LxxM series		-55 to +125	

\*1 AN79L04, AN79L05/M, AN79L06, AN79L07/M, AN79L08/M, AN79L09/M, AN79L10/M, AN79L12/M, AN79L15/M, AN79L18

\*2 AN79L20, AN79L24

\*3 Follow the derating curve. When  $T_j$  exceeds  $150^\circ\text{C}$ , the internal circuit cuts off the output.

AN79LxxM series is mounted on a standard board (glass epoxy: 20mm × 20mm × t1.7mm with Cu foil of 1cm<sup>2</sup> or more).

### ■ Electrical Characteristics at $T_a = 25^\circ\text{C}$

#### • AN79L04 (-4V type)

Parameter	Symbol	Conditions	Min	Typ	Max	Unit
Output voltage	$V_O$	$T_j = 25^\circ\text{C}$	-3.84	-4	-4.16	V
Output voltage tolerance	$V_O$	$V_I = -7$ to $-19\text{V}$ , $I_O = 1$ to $70\text{mA}$	-3.8	—	-4.2	V
Line regulation	$REG_{IN}$	$V_I = -6$ to $-20\text{V}$ , $T_j = 25^\circ\text{C}$	—	—	80	mV
		$V_I = -7$ to $-17\text{V}$ , $T_j = 25^\circ\text{C}$	—	—	40	mV
Load regulation	$REG_L$	$I_O = 1$ to $100\text{mA}$ , $T_j = 25^\circ\text{C}$	—	10	60	mV
		$I_O = 1$ to $40\text{mA}$ , $T_j = 25^\circ\text{C}$	—	4.5	30	mV
Bias current	$I_{Bias}$	$T_j = 25^\circ\text{C}$	—	3	5	mA
Bias current fluctuation to input	$\Delta I_{Bias(IN)}$	$V_I = -7$ to $-19\text{V}$ , $T_j = 25^\circ\text{C}$	—	—	0.5	mA
Bias current fluctuation to load	$\Delta I_{Bias(L)}$	$I_O = 1$ to $40\text{mA}$ , $T_j = 25^\circ\text{C}$	—	—	0.1	mA
Output noise voltage	$V_{no}$	$f = 10\text{Hz}$ to $100\text{kHz}$ , $T_a = 25^\circ\text{C}$	—	38	—	$\mu\text{V}$
Ripple rejection ratio	RR	$V_I = -7$ to $-17\text{V}$ , $f = 120\text{Hz}$ , $T_a = 25^\circ\text{C}$	55	—	—	dB
Minimum input/output voltage difference	$V_{DIF(min)}$	$T_j = 25^\circ\text{C}$	—	0.8	—	V
Output short-circuit current	$I_{O(Short)}$	$V_I = -35\text{V}$ , $T_j = 25^\circ\text{C}$	—	200	—	mA
Output voltage temperature coefficient	$\Delta V_O/T_a$	$I_O = 5\text{mA}$	—	-0.4	—	$\text{mV}/^\circ\text{C}$

Note 1) The specified condition  $T_j = 25^\circ\text{C}$  means that the test should be carried out within so short a test time (within 10ms) that the characteristic value drift due to the chip junction temperature rise can be ignored.

Note 2) Unless otherwise specified,  $V_I = -9\text{V}$ ,  $I_O = 40\text{mA}$ ,  $C_1 = 2\mu\text{F}$ ,  $C_O = 1\mu\text{F}$ ,  $T_j = 0$  to  $125^\circ\text{C}$

### ■ Electrical Characteristics at $T_a = 25^\circ\text{C}$ (continued)

#### • AN79L05, AN79L05M (–5V type)

Parameter	Symbol	Conditions	Min	Typ	Max	Unit
Output voltage	$V_O$	$T_j = 25^\circ\text{C}$	–4.8	–5	–5.2	V
Output voltage tolerance	$V_O$	$V_I = -8$ to $-20\text{V}$ , $I_O = 1$ to $70\text{mA}$	–4.75	—	–5.25	V
Line regulation	$\text{REG}_{\text{IN}}$	$V_I = -7$ to $-21\text{V}$ , $T_j = 25^\circ\text{C}$	—	—	100	mV
		$V_I = -8$ to $-18\text{V}$ , $T_j = 25^\circ\text{C}$	—	—	50	mV
Load regulation	$\text{REG}_{\text{L}}$	$I_O = 1$ to $100\text{mA}$ , $T_j = 25^\circ\text{C}$	—	11	60	mV
		$I_O = 1$ to $40\text{mA}$ , $T_j = 25^\circ\text{C}$	—	5	30	mV
Bias current	$I_{\text{Bias}}$	$T_j = 25^\circ\text{C}$	—	3	5	mA
Bias current fluctuation to input	$\Delta I_{\text{Bias(IN)}}$	$V_I = -8$ to $-20\text{V}$ , $T_j = 25^\circ\text{C}$	—	—	0.5	mA
Bias current fluctuation to load	$\Delta I_{\text{Bias(L)}}$	$I_O = 1$ to $40\text{mA}$ , $T_j = 25^\circ\text{C}$	—	—	0.1	mA
Output noise voltage	$V_{\text{no}}$	$f = 10\text{Hz}$ to $100\text{kHz}$ , $T_a = 25^\circ\text{C}$	—	40	—	$\mu\text{V}$
Ripple rejection ratio	RR	$V_I = -8$ to $-18\text{V}$ , $f = 120\text{Hz}$ , $T_a = 25^\circ\text{C}$	55	—	—	dB
Minimum input/output voltage difference	$V_{\text{DIF(min)}}$	$T_j = 25^\circ\text{C}$	—	0.8	—	V
Output short-circuit current	$I_{\text{O(Short)}}$	$V_I = -35\text{V}$ , $T_j = 25^\circ\text{C}$	—	200	—	mA
Output voltage temperature coefficient	$\Delta V_O/T_a$	$I_O = 5\text{mA}$	—	–0.4	—	$\text{mV}/^\circ\text{C}$

Note 1) The specified condition  $T_j = 25^\circ\text{C}$  means that the test should be carried out within so short a test time (within 10ms) that the characteristic value drift due to the chip junction temperature rise can be ignored.

Note 2) Unless otherwise specified,  $V_I = -10\text{V}$ ,  $I_O = 40\text{mA}$ ,  $C_I = 2\mu\text{F}$ ,  $C_O = 1\mu\text{F}$ ,  $T_j = 0$  to  $125^\circ\text{C}$  (AN79L05) and  $T_j = 0$  to  $100^\circ\text{C}$  (AN79L05M)

#### • AN79L06 (–6V type)

Parameter	Symbol	Conditions	Min	Typ	Max	Unit
Output voltage	$V_O$	$T_j = 25^\circ\text{C}$	–5.76	–6	–6.24	V
Output voltage tolerance	$V_O$	$V_I = -9$ to $-21\text{V}$ , $I_O = 1$ to $70\text{mA}$	–5.7	—	–6.3	V
Line regulation	$\text{REG}_{\text{IN}}$	$V_I = -8$ to $-22\text{V}$ , $T_j = 25^\circ\text{C}$	—	—	120	mV
		$V_I = -9$ to $-19\text{V}$ , $T_j = 25^\circ\text{C}$	—	—	60	mV
Load regulation	$\text{REG}_{\text{L}}$	$I_O = 1$ to $100\text{mA}$ , $T_j = 25^\circ\text{C}$	—	12	60	mV
		$I_O = 1$ to $40\text{mA}$ , $T_j = 25^\circ\text{C}$	—	5.5	30	mV
Bias current	$I_{\text{Bias}}$	$T_j = 25^\circ\text{C}$	—	3	5	mA
Bias current fluctuation to input	$\Delta I_{\text{Bias(IN)}}$	$V_I = -9$ to $-21\text{V}$ , $T_j = 25^\circ\text{C}$	—	—	0.5	mA
Bias current fluctuation to load	$\Delta I_{\text{Bias(L)}}$	$I_O = 1$ to $40\text{mA}$ , $T_j = 25^\circ\text{C}$	—	—	0.1	mA
Output noise voltage	$V_{\text{no}}$	$f = 10\text{Hz}$ to $100\text{kHz}$ , $T_a = 25^\circ\text{C}$	—	44	—	$\mu\text{V}$
Ripple rejection ratio	RR	$V_I = -9$ to $-19\text{V}$ , $f = 120\text{Hz}$ , $T_a = 25^\circ\text{C}$	55	—	—	dB
Minimum input/output voltage difference	$V_{\text{DIF(min)}}$	$T_j = 25^\circ\text{C}$	—	0.8	—	V
Output short-circuit current	$I_{\text{O(Short)}}$	$V_I = -35\text{V}$ , $T_j = 25^\circ\text{C}$	—	200	—	mA
Output voltage temperature coefficient	$\Delta V_O/T_a$	$I_O = 5\text{mA}$	—	–0.4	—	$\text{mV}/^\circ\text{C}$

Note 1) The specified condition  $T_j = 25^\circ\text{C}$  means that the test should be carried out within so short a test time (within 10ms) that the characteristic value drift due to the chip junction temperature rise can be ignored.

Note 2) Unless otherwise specified,  $V_I = -11\text{V}$ ,  $I_O = 40\text{mA}$ ,  $C_I = 2\mu\text{F}$ ,  $C_O = 1\mu\text{F}$ ,  $T_j = 0$  to  $125^\circ\text{C}$

■ Electrical Characteristics at  $T_a = 25^\circ\text{C}$  (continued)

• AN79L07, AN79L07M (–7V type)

Parameter	Symbol	Conditions	Min	Typ	Max	Unit
Output voltage	$V_O$	$T_j = 25^\circ\text{C}$	–6.72	–7	–7.28	V
Output voltage tolerance	$V_O$	$V_I = -10$ to $-22\text{V}$ , $I_O = 1$ to $70\text{mA}$	–6.65	—	–7.35	V
Line regulation	$\text{REG}_{\text{IN}}$	$V_I = -9$ to $-23\text{V}$ , $T_j = 25^\circ\text{C}$	—	—	140	mV
		$V_I = -10$ to $-20\text{V}$ , $T_j = 25^\circ\text{C}$	—	—	70	mV
Load regulation	$\text{REG}_{\text{L}}$	$I_O = 1$ to $100\text{mA}$ , $T_j = 25^\circ\text{C}$	—	13	70	mV
		$I_O = 1$ to $40\text{mA}$ , $T_j = 25^\circ\text{C}$	—	6	40	mV
Bias current	$I_{\text{Bias}}$	$T_j = 25^\circ\text{C}$	—	3	5	mA
Bias current fluctuation to input	$\Delta I_{\text{Bias(IN)}}$	$V_I = -10$ to $-22\text{V}$ , $T_j = 25^\circ\text{C}$	—	—	0.5	mA
Bias current fluctuation to load	$\Delta I_{\text{Bias(L)}}$	$I_O = 1$ to $40\text{mA}$ , $T_j = 25^\circ\text{C}$	—	—	0.1	mA
Output noise voltage	$V_{\text{no}}$	$f = 10\text{Hz}$ to $100\text{kHz}$ , $T_a = 25^\circ\text{C}$	—	48	—	$\mu\text{V}$
Ripple rejection ratio	RR	$V_I = -10$ to $-20\text{V}$ , $f = 120\text{Hz}$ , $T_a = 25^\circ\text{C}$	54	—	—	dB
Minimum input/output voltage difference	$V_{\text{DIF(min)}}$	$T_j = 25^\circ\text{C}$	—	0.8	—	V
Output short-circuit current	$I_{\text{O(Short)}}$	$V_I = -35\text{V}$ , $T_j = 25^\circ\text{C}$	—	200	—	mA
Output voltage temperature coefficient	$\Delta V_O/T_a$	$I_O = 5\text{mA}$	—	–0.5	—	$\text{mV}/^\circ\text{C}$

Note 1) The specified condition  $T_j = 25^\circ\text{C}$  means that the test should be carried out within so short a test time (within 10ms) that the characteristic value drift due to the chip junction temperature rise can be ignored.

Note 2) Unless otherwise specified,  $V_I = -12\text{V}$ ,  $I_O = 40\text{mA}$ ,  $C_I = 2\mu\text{F}$ ,  $C_O = 1\mu\text{F}$ ,  $T_j = 0$  to  $125^\circ\text{C}$  (AN79L07) and  $T_j = 0$  to  $100^\circ\text{C}$  (AN79L07M)

• AN79L08, AN79L08M (–8V type)

Parameter	Symbol	Conditions	Min	Typ	Max	Unit
Output voltage	$V_O$	$T_j = 25^\circ\text{C}$	–7.68	–8	–8.32	V
Output voltage tolerance	$V_O$	$V_I = -11$ to $-23\text{V}$ , $I_O = 1$ to $70\text{mA}$	–7.6	—	–8.4	V
Line regulation	$\text{REG}_{\text{IN}}$	$V_I = -10$ to $-24\text{V}$ , $T_j = 25^\circ\text{C}$	—	—	160	mV
		$V_I = -11$ to $-21\text{V}$ , $T_j = 25^\circ\text{C}$	—	—	80	mV
Load regulation	$\text{REG}_{\text{L}}$	$I_O = 1$ to $100\text{mA}$ , $T_j = 25^\circ\text{C}$	—	15	80	mV
		$I_O = 1$ to $40\text{mA}$ , $T_j = 25^\circ\text{C}$	—	7	40	mV
Bias current	$I_{\text{Bias}}$	$T_j = 25^\circ\text{C}$	—	3	5	mA
Bias current fluctuation to input	$\Delta I_{\text{Bias(IN)}}$	$V_I = -11$ to $-23\text{V}$ , $T_j = 25^\circ\text{C}$	—	—	0.5	mA
Bias current fluctuation to load	$\Delta I_{\text{Bias(L)}}$	$I_O = 1$ to $40\text{mA}$ , $T_j = 25^\circ\text{C}$	—	—	0.1	mA
Output noise voltage	$V_{\text{no}}$	$f = 10\text{Hz}$ to $100\text{kHz}$ , $T_a = 25^\circ\text{C}$	—	52	—	$\mu\text{V}$
Ripple rejection ratio	RR	$V_I = -11$ to $-21\text{V}$ , $f = 120\text{Hz}$ , $T_a = 25^\circ\text{C}$	54	—	—	dB
Minimum input/output voltage difference	$V_{\text{DIF(min)}}$	$T_j = 25^\circ\text{C}$	—	0.8	—	V
Output short-circuit current	$I_{\text{O(Short)}}$	$V_I = -35\text{V}$ , $T_j = 25^\circ\text{C}$	—	200	—	mA
Output voltage temperature coefficient	$\Delta V_O/T_a$	$I_O = 5\text{mA}$ , $T_j = 0$ to $125^\circ\text{C}$	—	–0.6	—	$\text{mV}/^\circ\text{C}$

Note 1) The specified condition  $T_j = 25^\circ\text{C}$  means that the test should be carried out within so short a test time (within 10ms) that the characteristic value drift due to the chip junction temperature rise can be ignored.

Note 2) Unless otherwise specified,  $V_I = -14\text{V}$ ,  $I_O = 40\text{mA}$ ,  $C_I = 2\mu\text{F}$ ,  $C_O = 1\mu\text{F}$ ,  $T_j = 0$  to  $125^\circ\text{C}$  (AN79L08) and  $T_j = 0$  to  $100^\circ\text{C}$  (AN79L08M)

### ■ Electrical Characteristics at $T_a = 25^\circ\text{C}$ (continued)

#### • AN79L09, AN79L09M (–9V type)

Parameter	Symbol	Conditions	Min	Typ	Max	Unit
Output voltage	$V_O$	$T_j = 25^\circ\text{C}$	–8.64	–9	–9.36	V
Output voltage tolerance	$V_O$	$V_I = -12$ to $-24\text{V}$ , $I_O = 1$ to $70\text{mA}$	–8.55	—	–9.45	V
Line regulation	$\text{REG}_{\text{IN}}$	$V_I = -11$ to $-25\text{V}$ , $T_j = 25^\circ\text{C}$	—	—	160	mV
		$V_I = -12$ to $-22\text{V}$ , $T_j = 25^\circ\text{C}$	—	—	80	mV
Load regulation	$\text{REG}_{\text{L}}$	$I_O = 1$ to $100\text{mA}$ , $T_j = 25^\circ\text{C}$	—	16	90	mV
		$I_O = 1$ to $40\text{mA}$ , $T_j = 25^\circ\text{C}$	—	8	50	mV
Bias current	$I_{\text{Bias}}$	$T_j = 25^\circ\text{C}$	—	3	5	mA
Bias current fluctuation to input	$\Delta I_{\text{Bias(IN)}}$	$V_I = -12$ to $-24\text{V}$ , $T_j = 25^\circ\text{C}$	—	—	0.5	mA
Bias current fluctuation to load	$\Delta I_{\text{Bias(L)}}$	$I_O = 1$ to $40\text{mA}$ , $T_j = 25^\circ\text{C}$	—	—	0.1	mA
Output noise voltage	$V_{\text{no}}$	$f = 10\text{Hz}$ to $100\text{kHz}$ , $T_a = 25^\circ\text{C}$	—	58	—	$\mu\text{V}$
Ripple rejection ratio	RR	$V_I = -12$ to $-22\text{V}$ , $f = 120\text{Hz}$ , $T_a = 25^\circ\text{C}$	53	—	—	dB
Minimum input/output voltage difference	$V_{\text{DIF(min)}}$	$T_j = 25^\circ\text{C}$	—	0.8	—	V
Output short-circuit current	$I_{\text{O(Short)}}$	$V_I = -35\text{V}$ , $T_j = 25^\circ\text{C}$	—	200	—	mA
Output voltage temperature coefficient	$\Delta V_O/T_a$	$I_O = 5\text{mA}$ , $T_j = 0$ to $125^\circ\text{C}$	—	–0.6	—	$\text{mV}/^\circ\text{C}$

Note 1) The specified condition  $T_j = 25^\circ\text{C}$  means that the test should be carried out within so short a test time (within 10ms) that the characteristic value drift due to the chip junction temperature rise can be ignored.

Note 2) Unless otherwise specified,  $V_I = -15\text{V}$ ,  $I_O = 40\text{mA}$ ,  $C_I = 2\mu\text{F}$ ,  $C_O = 1\mu\text{F}$ ,  $T_j = 0$  to  $125^\circ\text{C}$  (AN79L09) and  $T_j = 0$  to  $100^\circ\text{C}$  (AN79L09M)

#### • AN79L10, AN79L10M (–10V type)

Parameter	Symbol	Conditions	Min	Typ	Max	Unit
Output voltage	$V_O$	$T_j = 25^\circ\text{C}$	–9.6	–10	–10.4	V
Output voltage tolerance	$V_O$	$V_I = -13$ to $-25\text{V}$ , $I_O = 1$ to $70\text{mA}$	–9.5	—	–10.5	V
Line regulation	$\text{REG}_{\text{IN}}$	$V_I = -12$ to $-26\text{V}$ , $T_j = 25^\circ\text{C}$	—	—	160	mV
		$V_I = -13$ to $-23\text{V}$ , $T_j = 25^\circ\text{C}$	—	—	80	mV
Load regulation	$\text{REG}_{\text{L}}$	$I_O = 1$ to $100\text{mA}$ , $T_j = 25^\circ\text{C}$	—	17	100	mV
		$I_O = 1$ to $40\text{mA}$ , $T_j = 25^\circ\text{C}$	—	9	50	mV
Bias current	$I_{\text{Bias}}$	$T_j = 25^\circ\text{C}$	—	3	5	mA
Bias current fluctuation to input	$\Delta I_{\text{Bias(IN)}}$	$V_I = -13$ to $-25\text{V}$ , $T_j = 25^\circ\text{C}$	—	—	0.5	mA
Bias current fluctuation to load	$\Delta I_{\text{Bias(L)}}$	$I_O = 1$ to $40\text{mA}$ , $T_j = 25^\circ\text{C}$	—	—	0.1	mA
Output noise voltage	$V_{\text{no}}$	$f = 10\text{Hz}$ to $100\text{kHz}$ , $T_a = 25^\circ\text{C}$	—	65	—	$\mu\text{V}$
Ripple rejection ratio	RR	$V_I = -13$ to $-23\text{V}$ , $f = 120\text{Hz}$ , $T_a = 25^\circ\text{C}$	53	—	—	dB
Minimum input/output voltage difference	$V_{\text{DIF(min)}}$	$T_j = 25^\circ\text{C}$	—	0.8	—	V
Output short-circuit current	$I_{\text{O(Short)}}$	$V_I = -35\text{V}$ , $T_j = 25^\circ\text{C}$	—	200	—	mA
Output voltage temperature coefficient	$\Delta V_O/T_a$	$I_O = 5\text{mA}$	—	–0.7	—	$\text{mV}/^\circ\text{C}$

Note 1) The specified condition  $T_j = 25^\circ\text{C}$  means that the test should be carried out within so short a test time (within 10ms) that the characteristic value drift due to the chip junction temperature rise can be ignored.

Note 2) Unless otherwise specified,  $V_I = -16\text{V}$ ,  $I_O = 40\text{mA}$ ,  $C_I = 2\mu\text{F}$ ,  $C_O = 1\mu\text{F}$ ,  $T_j = 0$  to  $125^\circ\text{C}$  (AN79L10) and  $T_j = 0$  to  $100^\circ\text{C}$  (AN79L10M)

■ Electrical Characteristics at  $T_a = 25^\circ\text{C}$  (continued)

• AN79L12, AN79L12M (–12V type)

Parameter	Symbol	Conditions	Min	Typ	Max	Unit
Output voltage	$V_O$	$T_j = 25^\circ\text{C}$	-11.5	-12	-12.5	V
Output voltage tolerance	$V_O$	$V_I = -15$ to $-27\text{V}$ , $I_O = 1$ to $70\text{mA}$	-11.4	—	-12.6	V
Line regulation	REG <sub>IN</sub>	$V_I = -14.5$ to $-30\text{V}$ , $T_j = 25^\circ\text{C}$	—	—	200	mV
		$V_I = -15$ to $-25\text{V}$ , $T_j = 25^\circ\text{C}$	—	—	100	mV
Load regulation	REG <sub>L</sub>	$I_O = 1$ to $100\text{mA}$ , $T_j = 25^\circ\text{C}$	—	20	100	mV
		$I_O = 1$ to $40\text{mA}$ , $T_j = 25^\circ\text{C}$	—	10	50	mV
Bias current	$I_{\text{Bias}}$	$T_j = 25^\circ\text{C}$	—	3	5	mA
Bias current fluctuation to input	$\Delta I_{\text{Bias(IN)}}$	$V_I = -15$ to $-27\text{V}$ , $T_j = 25^\circ\text{C}$	—	—	0.5	mA
Bias current fluctuation to load	$\Delta I_{\text{Bias(L)}}$	$I_O = 1$ to $40\text{mA}$ , $T_j = 25^\circ\text{C}$	—	—	0.1	mA
Output noise voltage	$V_{\text{no}}$	$f = 10\text{Hz}$ to $100\text{kHz}$ , $T_a = 25^\circ\text{C}$	—	75	—	$\mu\text{V}$
Ripple rejection ratio	RR	$V_I = -15$ to $-25\text{V}$ , $f = 120\text{Hz}$ , $T_a = 25^\circ\text{C}$	52	—	—	dB
Minimum input/output voltage difference	$V_{\text{DIF(min)}}$	$T_j = 25^\circ\text{C}$	—	0.8	—	V
Output short-circuit current	$I_{\text{O(Short)}}$	$V_I = -35\text{V}$ , $T_j = 25^\circ\text{C}$	—	200	—	mA
Output voltage temperature coefficient	$\Delta V_O/T_a$	$I_O = 5\text{mA}$	—	-0.8	—	mV/ $^\circ\text{C}$

Note 1) The specified condition  $T_j = 25^\circ\text{C}$  means that the test should be carried out within so short a test time (within 10ms) that the characteristic value drift due to the chip junction temperature rise can be ignored.

Note 2) Unless otherwise specified,  $V_I = -19\text{V}$ ,  $I_O = 40\text{mA}$ ,  $C_I = 2\mu\text{F}$ ,  $C_O = 1\mu\text{F}$ ,  $T_j = 0$  to  $125^\circ\text{C}$  (AN79L12) and  $T_j = 0$  to  $100^\circ\text{C}$  (AN79L12M)

• AN79L15, AN79L15M (–15V type)

Parameter	Symbol	Conditions	Min	Typ	Max	Unit
Output voltage	$V_O$	$T_j = 25^\circ\text{C}$	-14.4	-15	-15.6	V
Output voltage tolerance	$V_O$	$V_I = -18$ to $-28\text{V}$ , $I_O = 1$ to $70\text{mA}$	-14.25	—	-15.75	V
Line regulation	REG <sub>IN</sub>	$V_I = -17.5$ to $-33\text{V}$ , $T_j = 25^\circ\text{C}$	—	—	200	mV
		$V_I = -18$ to $-28\text{V}$ , $T_j = 25^\circ\text{C}$	—	—	100	mV
Load regulation	REG <sub>L</sub>	$I_O = 1$ to $100\text{mA}$ , $T_j = 25^\circ\text{C}$	—	25	130	mV
		$I_O = 1$ to $40\text{mA}$ , $T_j = 25^\circ\text{C}$	—	12	60	mV
Bias current	$I_{\text{Bias}}$	$T_j = 25^\circ\text{C}$	—	3	5	mA
Bias current fluctuation to input	$\Delta I_{\text{Bias(IN)}}$	$V_I = -18$ to $-30\text{V}$ , $T_j = 25^\circ\text{C}$	—	—	0.5	mA
Bias current fluctuation to load	$\Delta I_{\text{Bias(L)}}$	$I_O = 1$ to $40\text{mA}$ , $T_j = 25^\circ\text{C}$	—	—	0.1	mA
Output noise voltage	$V_{\text{no}}$	$f = 10\text{Hz}$ to $100\text{kHz}$ , $T_a = 25^\circ\text{C}$	—	90	—	$\mu\text{V}$
Ripple rejection ratio	RR	$V_I = -18$ to $-28\text{V}$ , $f = 120\text{Hz}$ , $T_a = 25^\circ\text{C}$	51	—	—	dB
Minimum input/output voltage difference	$V_{\text{DIF(min)}}$	$T_j = 25^\circ\text{C}$	—	0.8	—	V
Output short-circuit current	$I_{\text{O(Short)}}$	$V_I = -35\text{V}$ , $T_j = 25^\circ\text{C}$	—	200	—	mA
Output voltage temperature coefficient	$\Delta V_O/T_a$	$I_O = 5\text{mA}$	—	-0.9	—	mV/ $^\circ\text{C}$

Note 1) The specified condition  $T_j = 25^\circ\text{C}$  means that the test should be carried out within so short a test time (within 10ms) that the characteristic value drift due to the chip junction temperature rise can be ignored.

Note 2) Unless otherwise specified,  $V_I = -23\text{V}$ ,  $I_O = 40\text{mA}$ ,  $C_I = 2\mu\text{F}$ ,  $C_O = 1\mu\text{F}$ ,  $T_j = 0$  to  $125^\circ\text{C}$  (AN79L15) and  $T_j = 0$  to  $100^\circ\text{C}$  (AN79L15M)

### ■ Electrical Characteristics at $T_a = 25^\circ\text{C}$ (continued)

#### • AN79L18 (-18V type)

Parameter	Symbol	Conditions	Min	Typ	Max	Unit
Output voltage	$V_O$	$T_j = 25^\circ\text{C}$	-17.3	-18	-18.7	V
Output voltage tolerance	$V_O$	$V_I = -21$ to $-33\text{V}$ , $I_O = 1$ to $70\text{mA}$	-17.1	—	-18.9	V
Line regulation	$\text{REG}_{\text{IN}}$	$V_I = -21$ to $-33\text{V}$ , $T_j = 25^\circ\text{C}$	—	—	200	mV
		$V_I = -21$ to $-32\text{V}$ , $T_j = 25^\circ\text{C}$	—	—	100	mV
Load regulation	$\text{REG}_{\text{L}}$	$I_O = 1$ to $100\text{mA}$ , $T_j = 25^\circ\text{C}$	—	30	160	mV
		$I_O = 1$ to $40\text{mA}$ , $T_j = 25^\circ\text{C}$	—	15	80	mV
Bias current	$I_{\text{Bias}}$	$T_j = 25^\circ\text{C}$	—	3	5	mA
Bias current fluctuation to input	$\Delta I_{\text{Bias(IN)}}$	$V_I = -21$ to $-33\text{V}$ , $T_j = 25^\circ\text{C}$	—	—	0.5	mA
Bias current fluctuation to load	$\Delta I_{\text{Bias(L)}}$	$I_O = 1$ to $40\text{mA}$ , $T_j = 25^\circ\text{C}$	—	—	0.1	mA
Output noise voltage	$V_{\text{no}}$	$f = 10\text{Hz}$ to $100\text{kHz}$ , $T_a = 25^\circ\text{C}$	—	110	—	$\mu\text{V}$
Ripple rejection ratio	RR	$V_I = -22$ to $-32\text{V}$ , $f = 120\text{Hz}$ , $T_a = 25^\circ\text{C}$	50	—	—	dB
Minimum input/output voltage difference	$V_{\text{DIF(min)}}$	$T_j = 25^\circ\text{C}$	—	0.8	—	V
Output short-circuit current	$I_{\text{O(Short)}}$	$V_I = -35\text{V}$ , $T_j = 25^\circ\text{C}$	—	200	—	mA
Output voltage temperature coefficient	$\Delta V_O/T_a$	$I_O = 5\text{mA}$	—	-1	—	$\text{mV}/^\circ\text{C}$

Note 1) The specified condition  $T_j = 25^\circ\text{C}$  means that the test should be carried out within so short a test time (within 10ms) that the characteristic value drift due to the chip junction temperature rise can be ignored.

Note 2) Unless otherwise specified,  $V_I = -27\text{V}$ ,  $I_O = 40\text{mA}$ ,  $C_I = 2\mu\text{F}$ ,  $C_O = 1\mu\text{F}$ ,  $T_j = 0$  to  $125^\circ\text{C}$

#### • AN79L20 (-20V type)

Parameter	Symbol	Conditions	Min	Typ	Max	Unit
Output voltage	$V_O$	$T_j = 25^\circ\text{C}$	-19.2	-20	-20.8	V
Output voltage tolerance	$V_O$	$V_I = -23$ to $-35\text{V}$ , $I_O = 1$ to $70\text{mA}$	-19	—	-21	V
Line regulation	$\text{REG}_{\text{IN}}$	$V_I = -23$ to $-35\text{V}$ , $T_j = 25^\circ\text{C}$	—	—	200	mV
		$V_I = -24$ to $-34\text{V}$ , $T_j = 25^\circ\text{C}$	—	—	100	mV
Load regulation	$\text{REG}_{\text{L}}$	$I_O = 1$ to $100\text{mA}$ , $T_j = 25^\circ\text{C}$	—	35	180	mV
		$I_O = 1$ to $40\text{mA}$ , $T_j = 25^\circ\text{C}$	—	17	90	mV
Bias current	$I_{\text{Bias}}$	$T_j = 25^\circ\text{C}$	—	3	5	mA
Bias current fluctuation to input	$\Delta I_{\text{Bias(IN)}}$	$V_I = -23$ to $-35\text{V}$ , $T_j = 25^\circ\text{C}$	—	—	0.5	mA
Bias current fluctuation to load	$\Delta I_{\text{Bias(L)}}$	$I_O = 1$ to $40\text{mA}$ , $T_j = 25^\circ\text{C}$	—	—	0.1	mA
Output noise voltage	$V_{\text{no}}$	$f = 10\text{Hz}$ to $100\text{kHz}$ , $T_a = 25^\circ\text{C}$	—	135	—	$\mu\text{V}$
Ripple rejection ratio	RR	$V_I = -24$ to $-34\text{V}$ , $f = 120\text{Hz}$ , $T_a = 25^\circ\text{C}$	49	—	—	dB
Minimum input/output voltage difference	$V_{\text{DIF(min)}}$	$T_j = 25^\circ\text{C}$	—	0.8	—	V
Output short-circuit current	$I_{\text{O(Short)}}$	$V_I = -35\text{V}$ , $T_j = 25^\circ\text{C}$	—	200	—	mA
Output voltage temperature coefficient	$\Delta V_O/T_a$	$I_O = 5\text{mA}$	—	-1	—	$\text{mV}/^\circ\text{C}$

Note 1) The specified condition  $T_j = 25^\circ\text{C}$  means that the test should be carried out within so short a test time (within 10ms) that the characteristic value drift due to the chip junction temperature rise can be ignored.

Note 2) Unless otherwise specified,  $V_I = -29\text{V}$ ,  $I_O = 40\text{mA}$ ,  $C_I = 2\mu\text{F}$ ,  $C_O = 1\mu\text{F}$ ,  $T_j = 0$  to  $125^\circ\text{C}$

■ Electrical Characteristics at  $T_a = 25^\circ\text{C}$  (continued)

• AN79L24 (-24V type)

Parameter	Symbol	Conditions	Min	Typ	Max	Unit
Output voltage	$V_O$	$T_j = 25^\circ\text{C}$	-23	-24	-25	V
Output voltage tolerance	$V_O$	$V_I = -27$ to $-38\text{V}$ , $I_O = 1$ to $70\text{mA}$	-22.8	—	-25.2	V
Line regulation	$\text{REG}_{\text{IN}}$	$V_I = -27$ to $-38\text{V}$ , $T_j = 25^\circ\text{C}$	—	—	200	mV
		$V_I = -27$ to $-37\text{V}$ , $T_j = 25^\circ\text{C}$	—	—	100	mV
Load regulation	$\text{REG}_L$	$I_O = 1$ to $100\text{mA}$ , $T_j = 25^\circ\text{C}$	—	40	200	mV
		$I_O = 1$ to $40\text{mA}$ , $T_j = 25^\circ\text{C}$	—	20	100	mV
Bias current	$I_{\text{Bias}}$	$T_j = 25^\circ\text{C}$	—	3	5	mA
Bias current fluctuation to input	$\Delta I_{\text{Bias(IN)}}$	$V_I = -27$ to $-38\text{V}$ , $T_j = 25^\circ\text{C}$	—	—	0.5	mA
Bias current fluctuation to load	$\Delta I_{\text{Bias(L)}}$	$I_O = 1$ to $40\text{mA}$ , $T_j = 25^\circ\text{C}$	—	—	0.1	mA
Output noise voltage	$V_{\text{no}}$	$f = 10\text{Hz}$ to $100\text{kHz}$ , $T_a = 25^\circ\text{C}$	—	170	—	$\mu\text{V}$
Ripple rejection ratio	RR	$V_I = -28$ to $-38\text{V}$ , $f = 120\text{Hz}$ , $T_a = 25^\circ\text{C}$	49	—	—	dB
Minimum input/output voltage difference	$V_{\text{DIF(min)}}$	$T_j = 25^\circ\text{C}$	—	0.8	—	V
Output short-circuit current	$I_{\text{O(Short)}}$	$V_I = -35\text{V}$ , $T_j = 25^\circ\text{C}$	—	200	—	mA
Output voltage temperature coefficient	$\Delta V_O/T_a$	$I_O = 5\text{mA}$	—	-1	—	$\text{mV}/^\circ\text{C}$

Note 1) The specified condition  $T_j = 25^\circ\text{C}$  means that the test should be carried out within so short a test time (within 10ms) that the characteristic value drift due to the chip junction temperature rise can be ignored.

Note 2) Unless otherwise specified,  $V_I = -33\text{V}$ ,  $I_O = 40\text{mA}$ ,  $C_I = 2\mu\text{F}$ ,  $C_O = 1\mu\text{F}$ ,  $T_j = 0$  to  $125^\circ\text{C}$

■ Main Characteristics

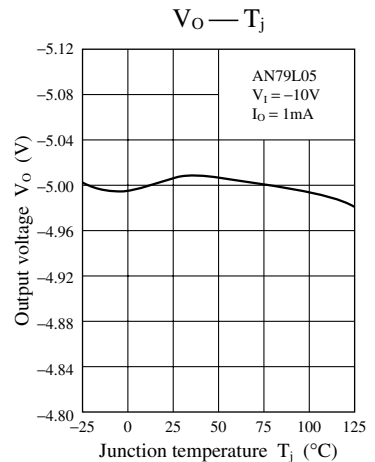
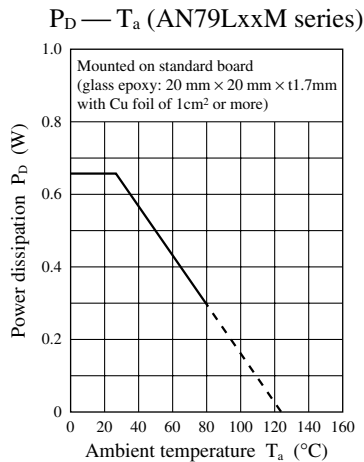
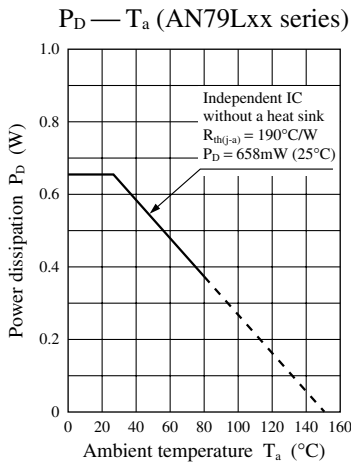

■ Main Characteristics (continued)

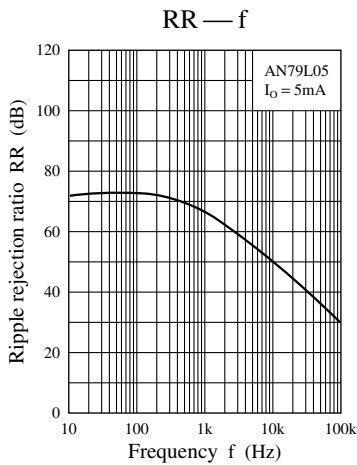
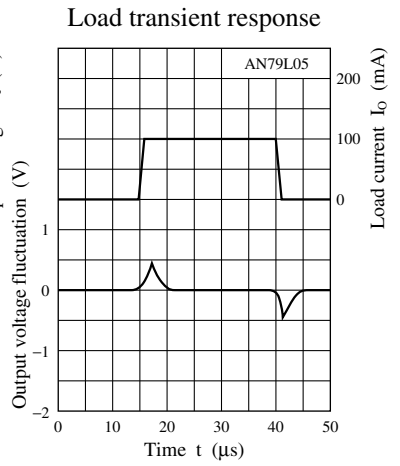
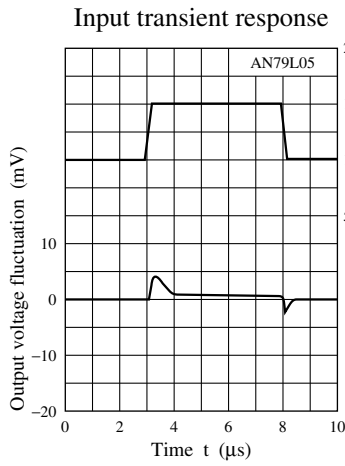
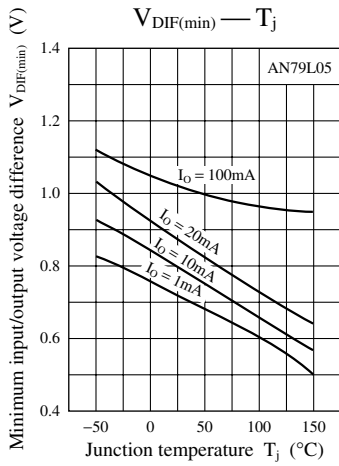

■ Basic Regulator Circuit

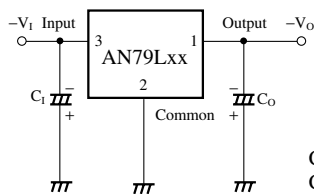

Connect C<sub>1</sub> of 2μF when the input line is long.  
C<sub>o</sub> improves the transient response. 1μF

■ Usage Notes

1. Cautions for a basic circuit

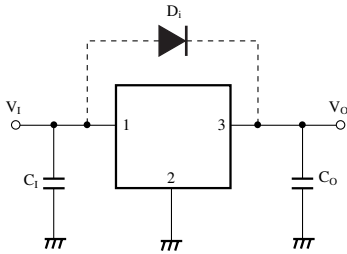

Figure 1

C<sub>1</sub>: When a wiring from a smoothing circuit to a three-pin regulator is long, it is likely to oscillate at output. A capacitor of 0.1μF to 0.47μF should be connected near an input pin.

C<sub>O</sub>: Deadly needed to prevent from oscillation (0.33μF to 1.0μF). It is recommended to use a capacitor of a small internal impedance (ex. tantalum capacitor) when using it under a low temperature.

When any sudden change of load current is likely to occur, connect an electrolytic capacitor of 10μF to 100μF to improve a transitional response of output voltage.

D<sub>1</sub>: Normally unnecessary. But add it in the case that there is a residual voltage at the output capacitor C<sub>O</sub> even after switching off the supply power because a current is likely to flow into an output pin of the IC and damage the IC.

2. Other caution items

1) Short-circuit between the input pin and GND pin

If the input pin is short-circuited to GND or is cut off when a large capacitance capacitor has been connected to the IC's load, a voltage of a capacitor connected to an output pin is applied between input/output of the IC and this likely results in damage of the IC. It is necessary, therefore, to connect a diode, as shown in figure 2, to counter the reverse bias between input/output pins.

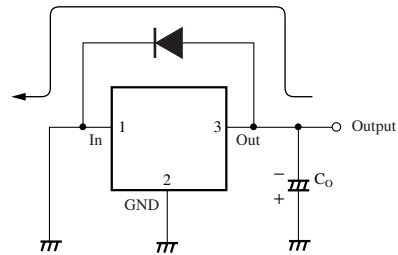
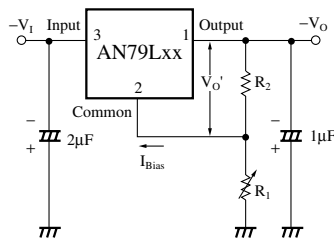

Figure 2

2) Floating of GND pin

If a GND pin is made floating in an operating mode, an unstabilized input voltage is outputted. In this case, a thermal protection circuit inside the IC does not normally operate. In this state, if the load is short-circuited or overloaded, it is likely to damage the IC.

■ Application Circuit Example



$$|V_O| = V_O' \left( 1 + \frac{R_1}{R_2} \right) + I_Q R_1$$

Note) V<sub>O</sub> varies due to sample to sample variation of I<sub>Bias</sub>.  
Never fail to adjust individually with R<sub>1</sub>.

■ New Package Dimensions (Unit: mm)

- SSIP003-P-0000S (Lead-free package)

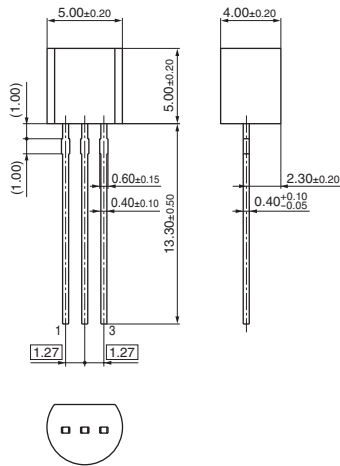

- HSIP003-P-0000Q (Lead-free package)

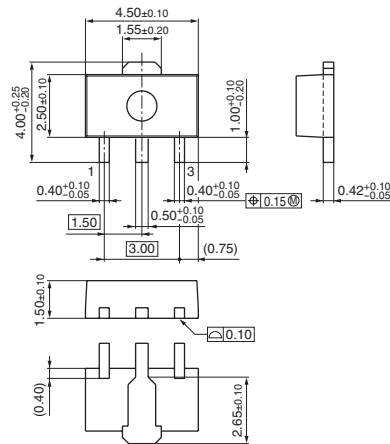

## Request for your special attention and precautions in using the technical information and semiconductors described in this material

- (1) An export permit needs to be obtained from the competent authorities of the Japanese Government if any of the products or technical information described in this material and controlled under the "Foreign Exchange and Foreign Trade Law" is to be exported or taken out of Japan.
- (2) The technical information described in this material is limited to showing representative characteristics and applied circuits examples of the products. It neither warrants non-infringement of intellectual property right or any other rights owned by our company or a third party, nor grants any license.
- (3) We are not liable for the infringement of rights owned by a third party arising out of the use of the technical information as described in this material.
- (4) The products described in this material are intended to be used for standard applications or general electronic equipment (such as office equipment, communications equipment, measuring instruments and household appliances).  
Consult our sales staff in advance for information on the following applications:
  - Special applications (such as for airplanes, aerospace, automobiles, traffic control equipment, combustion equipment, life support systems and safety devices) in which exceptional quality and reliability are required, or if the failure or malfunction of the products may directly jeopardize life or harm the human body.
  - Any applications other than the standard applications intended.
- (5) The products and product specifications described in this material are subject to change without notice for modification and/or improvement. At the final stage of your design, purchasing, or use of the products, therefore, ask for the most up-to-date Product Standards in advance to make sure that the latest specifications satisfy your requirements.
- (6) When designing your equipment, comply with the guaranteed values, in particular those of maximum rating, the range of operating power supply voltage, and heat radiation characteristics. Otherwise, we will not be liable for any defect which may arise later in your equipment.  
Even when the products are used within the guaranteed values, take into the consideration of incidence of break down and failure mode, possible to occur to semiconductor products. Measures on the systems such as redundant design, arresting the spread of fire or preventing glitch are recommended in order to prevent physical injury, fire, social damages, for example, by using the products.
- (7) When using products for which damp-proof packing is required, observe the conditions (including shelf life and amount of time let standing of unsealed items) agreed upon when specification sheets are individually exchanged.
- (8) This material may be not reprinted or reproduced whether wholly or partially, without the prior written permission of Matsushita Electric Industrial Co., Ltd.







## Looking for pricing, stock, or lifecycle information?

Click below to explore more details on WIN SOURCE:

 [View AN79L07ME1 on WIN SOURCE](#)

 [Panasonic Information](#)

## Optimize Your Supply Chain with WIN SOURCE Solutions

-  Global Sourcing Solution
-  Obsolete Management
-  Cost Control Management
-  Shortage Management
-  Alternative Solution
-  Excess Inventory Management