



THE DATASHEET OF
AP1118D90L-13



Not Recommended for New Design



AP1118

1A Positive Low Dropout Fixed-Mode Regulator With EN Function

■ Features

- 1.4V maximum dropout at full load current
- Fast transient response
- Output current limiting
- Built-in thermal shutdown
- Packages: TO220-5, TO252-5, TO263-5, SOP8
- Good noise rejection
- Fixed Output 1.5V, 1.8V, 2.5V, 3.3V, 5.0V, 9.0V, 12V
- Enable function

■ Applications

- PC peripheral
- Communication
- CDROM..

■ General Description

AP1118 is a low dropout positive fixed-mode regulator with minimum of 1A output current capability. The product is specifically designed to provide well-regulated supply for low voltage IC applications such as high-speed bus termination and low current 3.3V logic supply. AP1118 is also well suited for other applications such as VGA cards. AP1118 is guaranteed to have <1.4V dropout at full load current making it ideal to provide well regulated outputs of 1.25 to 12V with up to 18V input supply. The AP1118 offers a TTL – Logic compatible enable pin.

■ Ordering Information

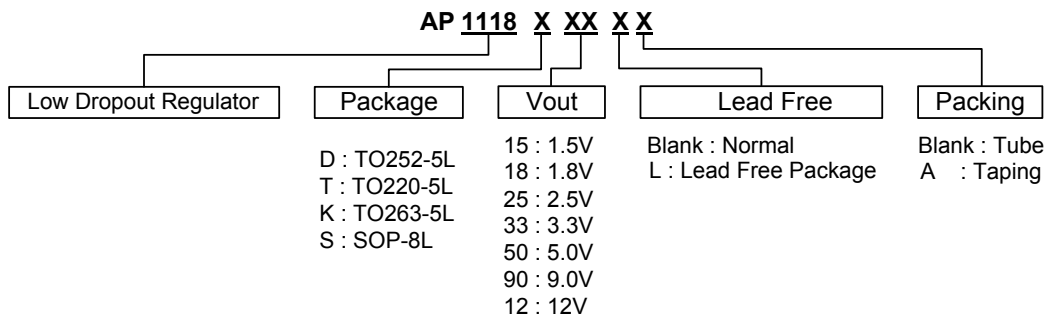

■ Typical Circuit

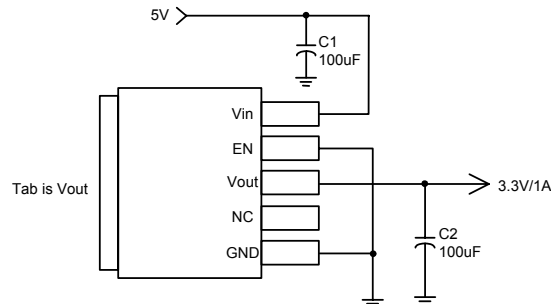

(5V/3.3V fixed output)

Not Recommended for New Design



AP1118

1A Positive Low Dropout Fixed-Mode Regulator With EN Function

■ Connection Diagram

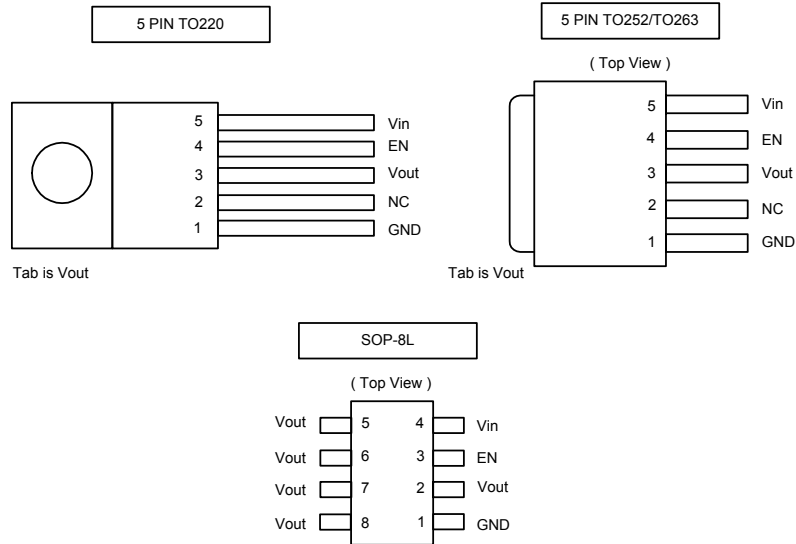

■ Pin Descriptions

NAME	FUNCTION
GND	Ground.
Vout	The output of the regulator. A minimum of 10uF capacitor must be connected from this pin to ground to insure stability.
Vin	The input pin of regulator. Typically a large storage capacitor is connected from this pin to ground to insure that the input voltage does not sag below the minimum dropout voltage during the load transient response. This pin must always be 1.3V higher than Vout in order for the device to regulate properly.
EN	The input pin of regulator. TTL/CMOS compatible input Logic high = disable output, Logic Low or open = output enable. (internal pull-down resistor~100 K).
NC	No connection.

Not Recommended for New Design



AP1118

1A Positive Low Dropout Fixed-Mode Regulator With EN Function

■ Absolute Maximum Ratings

Characteristics	Symbol	Values	Unit
DC Supply Voltage	V _{IN}	-0.3 to 18	V
Enable Pin Voltage	V _{EN}	7	V
Power Dissipation	P _D	Internally Limited	
Storage Temperature	T _{ST}	-65 to +150	°C
Operating Junction Temperature Range	T _{OP.}	0 to +150	°C

■ Electrical Characteristics (Under Operating Conditions)

PARAMETER	CONDITIONS		MIN	TYP	MAX	UNIT
Output Voltage	AP1118-1.5	I _{OUT} = 10mA, T _J = 25°C, 3V ≤ V _{IN} ≤ 15V	1.470	1.500	1.530	V
	AP1118-1.8	I _{OUT} = 10mA, T _J = 25°C, 3.3V ≤ V _{IN} ≤ 15V	1.764	1.800	1.836	V
	AP1118-2.5	I _{OUT} = 10mA, T _J = 25°C, 4V ≤ V _{IN} ≤ 15V	2.450	2.500	2.550	V
	AP1118-3.3	I _{OUT} = 10mA, T _J = 25°C, 4.8V ≤ V _{IN} ≤ 15V	3.235	3.300	3.365	V
	AP1118-5.0	I _{OUT} = 10mA, T _J = 25°C, 6.5V ≤ V _{IN} ≤ 15V	4.900	5.000	5.100	V
	AP1118-9.0	I _{OUT} = 10mA, T _J = 25°C, 10.5V ≤ V _{IN} ≤ 18V	8.820	9.000	9.180	V
	AP1118-12.0	I _{OUT} = 10mA, T _J = 25°C, 13.5V ≤ V _{IN} ≤ 18V	11.760	12.000	12.240	V
Line Regulation	AP1118-XXX	I _O = 10mA, V _{OUT} + 1.5V < V _{IN} < 18V, T _J = 25°C			0.2	%
Load Regulation	AP1118-1.5	V _{IN} = 3V, 0mA < I _O < 1A, T _J = 25°C (Note 1,2)		12	15	mV
	AP1118-1.8	V _{IN} = 3.3V, 0mA < I _O < 1A, T _J = 25°C (Note 1,2)		15	18	mV
	AP1118-2.5	V _{IN} = 4V, 0mA < I _O < 1A, T _J = 25°C (Note 1,2)		20	25	mV
	AP1118-3.3	V _{IN} = 5V, 0 ≤ I _{OUT} ≤ 1A, T _J = 25°C (Note 1,2)		26	33	mV
	AP1118-5.0	V _{IN} = 8V, 0 ≤ I _{OUT} ≤ 1A, T _J = 25°C (Note 1,2)		40	50	mV
	AP1118-9.0	V _{IN} = 12V, 0 ≤ I _{OUT} ≤ 1A, T _J = 25°C (Note 1,2)		70	90	mV
	AP1118-12.0	V _{IN} = 15V, 0 ≤ I _{OUT} ≤ 1A, T _J = 25°C (Note 1,2)		100	120	mV
Dropout Voltage (V _{IN} - V _{OUT})	AP1118- 1.5/1.8 2.5/3.3/5.0/9.0/12	I _{OUT} = 1A, ΔV _{OUT} = 0.1V		1.3	1.4	V

Not Recommended for New Design



AP1118

1A Positive Low Dropout Fixed-Mode Regulator With EN Function

■ Electrical Characteristics(Continued) (Under Operating Conditions)

PARAMETER	CONDITIONS		MIN	TYP	MAX	UNIT
Current Limit	AP1118- 1.5/1.8 2.5/3.3/5.0/9.1/12	$(V_{IN}-V_{OUT}) = 5V$	1.1			A
Minimum Load Current	AP1118-XXX	$0^{\circ}C \leq T_j \leq 125^{\circ}C$		5	10	mA
V_{EN}	Enable Input Voltage	Logic Low (ON)			0.8	V
		Logic High (OFF)	1.6			
I_{EN}	Enable Input Current	$V_{EN} = 0.8V$			10	μA
		$V_{EN} = 2.0V$			80	
Thermal Regulation	$T_A=25^{\circ}C$, 30ms pulse			0.008	0.04	%/W
Ripple Rejection	$F=120Hz, C_{OUT}=25\mu F$ Tantalum, $I_{OUT}=1A$					
	AP1118-XXX	$V_{IN}=V_{OUT}+3V$		60	70	dB
Temperature Stability	$I_O=10mA$			0.5		%
θ_{JA} Thermal Resistance Junction-to-Ambient(No heat sink ;No air flow)	SOP-8L			150		$^{\circ}C/W$
	TO-252-5L			102		
	TO-220-5L			85		
	TO263-5L			90		
θ_{JC} Thermal Resistance Junction-to-Case	SOP-8L		: Control Circuitry/Power Transistor	25		$^{\circ}C/W$
	TO-252-5L			15		
	TO-220-5L			0.65/2.7		
	TO263-5L			3.5		

Note1: See thermal regulation specifications for changes in output voltage due to heating effects. Line and load regulation are measured at a constant junction temperature by low duty cycle pulse testing. Load regulation is measured at the output lead = 1/18" from the package.

Note2: Line and load regulation are guaranteed up to the maximum power dissipation of 15W. Power dissipation is determined by the input/output differential and the output current. Guaranteed maximum power dissipation will not be available over the full input/output range.

Note3: Quiescent current is defined as the minimum output current required to maintain regulation. At 12V input/output differential the device is guaranteed to regulate if the output current is greater than 10mA.



1A Positive Low Dropout Fixed-Mode Regulator With EN Function

■ Typical Performance Characteristics

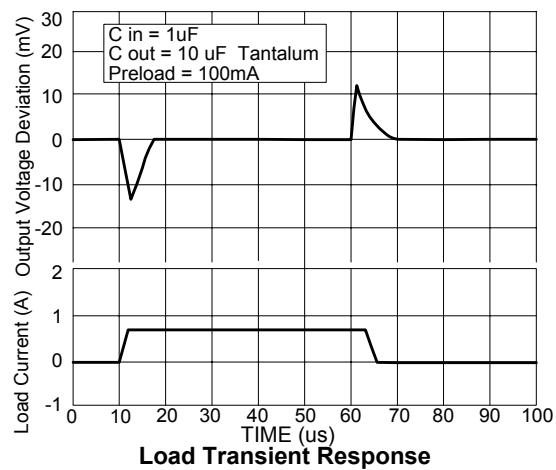
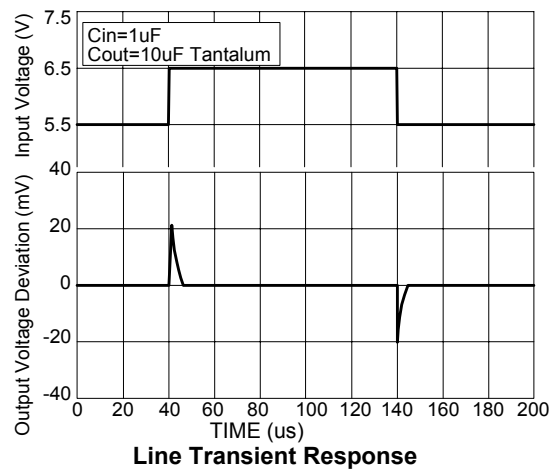
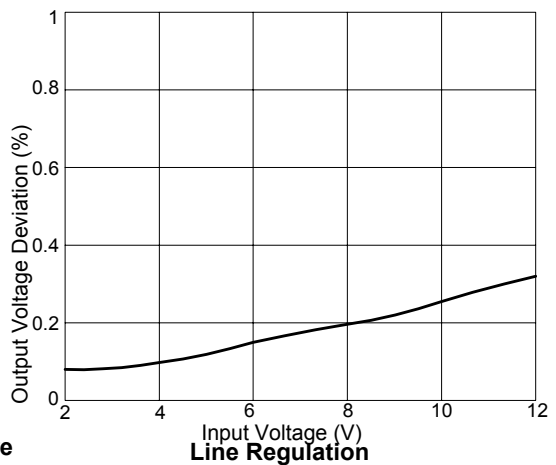
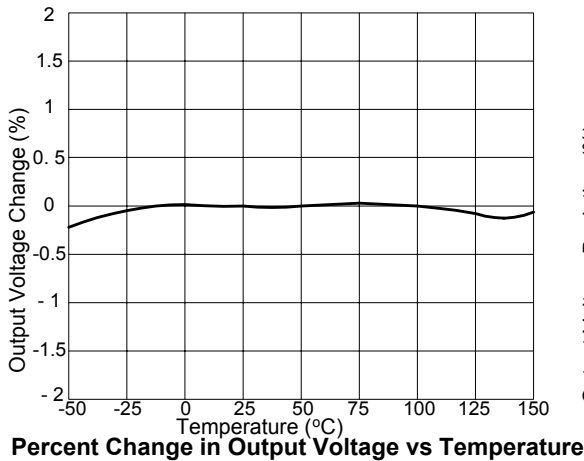
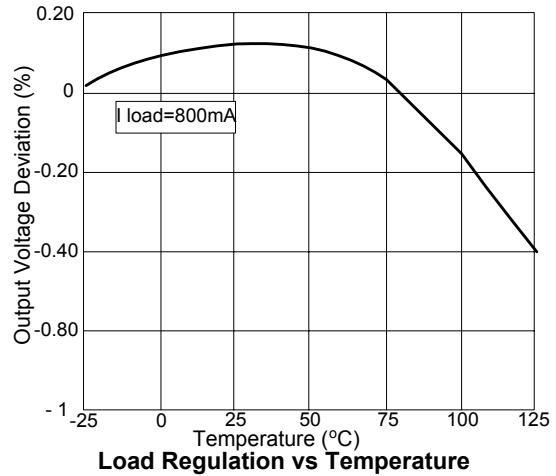
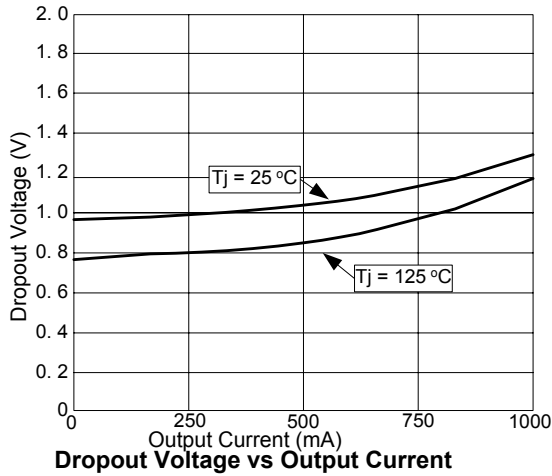

Not Recommended for New Design



AP1118

1A Positive Low Dropout Fixed-Mode Regulator With EN Function

■ Marking Information

(1) TO220-5L

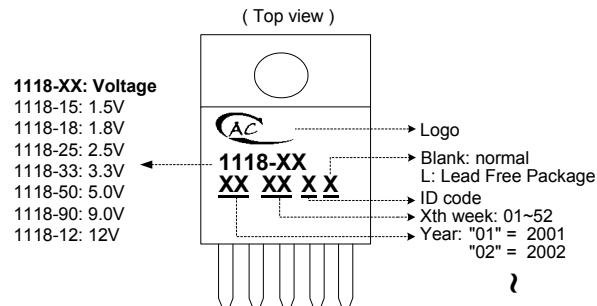

(2) TO252/TO263-5L

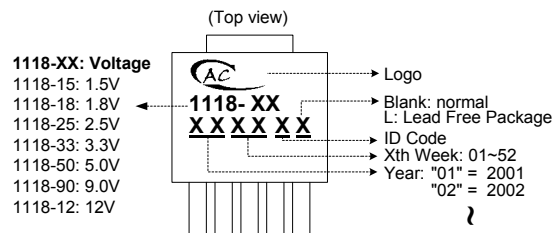

(3) SOP-8L

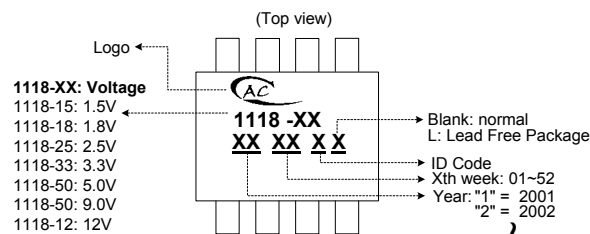

Not Recommended for New Design



AP1118

1A Positive Low Dropout Fixed-Mode Regulator With EN Function

■ Package Dimension

(1) TO220-5

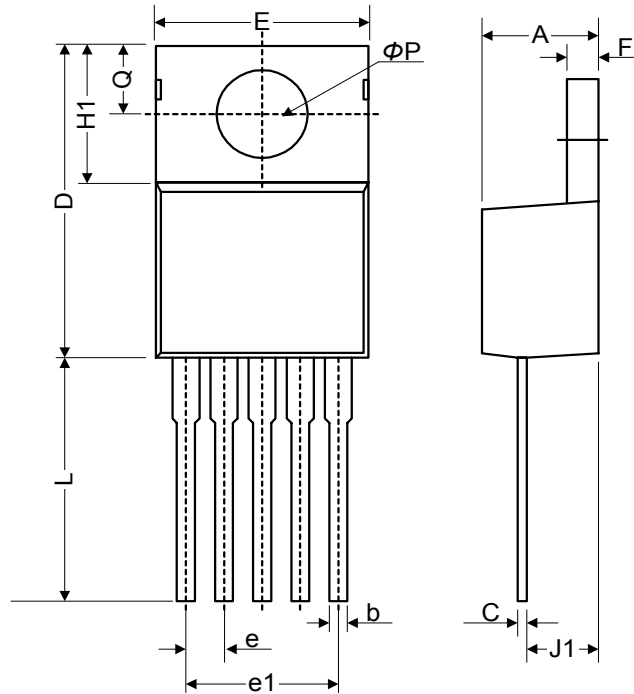

Symbol	Dimensions In Millimeters			Dimensions In Inches		
	Min.	Nom.	Max.	Min.	Nom.	Max.
A	4.07	4.45	4.82	0.160	0.175	0.190
b	0.76	0.89	1.02	0.030	0.035	0.040
C	0.36	0.50	0.64	0.014	0.020	0.025
D	14.22	14.86	15.50	0.560	0.585	0.610
E	9.78	10.16	10.54	0.385	0.400	0.415
e	1.57	1.71	1.85	0.062	0.067	0.073
e1	6.68	6.81	6.93	0.263	0.268	0.273
F	1.14	1.27	1.40	0.045	0.050	0.055
H1	5.46	6.16	6.86	0.215	0.243	0.270
J1	2.29	2.74	3.18	0.090	0.108	0.125
L	13.21	13.97	14.73	0.520	0.550	0.580
Øp	3.68	3.81	3.94	0.145	0.150	0.155
Q	2.54	2.73	2.92	0.100	0.107	0.115

Not Recommended for New Design



AP1118

1A Positive Low Dropout Fixed-Mode Regulator With EN Function

(2) TO252-5

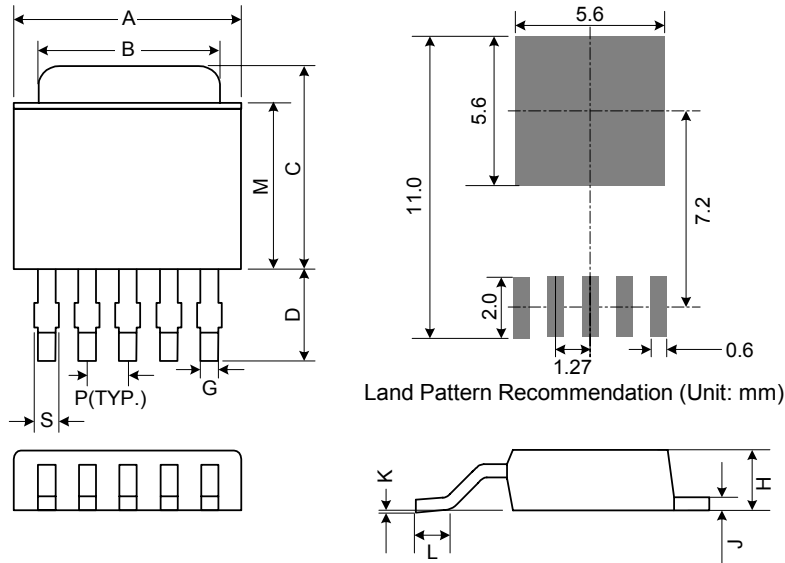

Symbol	Dimensions In Millimeters			Dimensions In Inches		
	Min.	Nom.	Max.	Min.	Nom.	Max.
A	6.35	6.60	6.85	0.250	0.260	0.270
B	5.20	5.35	5.50	0.205	0.211	0.217
C	6.80	7.00	7.30	0.268	0.276	0.287
D	2.20	2.50	2.80	0.087	0.098	0.110
P	1.27 REF.			0.050 REF.		
S	0.50	0.65	0.80	0.020	0.026	0.031
G	0.40	0.50	0.63	0.016	0.020	0.025
H	2.20	2.30	2.40	0.087	0.091	0.094
J	0.45	0.52	0.58	0.018	0.020	0.023
K	0.00	0.08	0.15	0.000	0.003	0.006
L	0.90	1.20	1.63	0.035	0.047	0.064
M	5.40	5.80	6.20	0.213	0.228	0.244

Not Recommended for New Design



AP1118

1A Positive Low Dropout Fixed-Mode Regulator With EN Function

(3) TO263-5

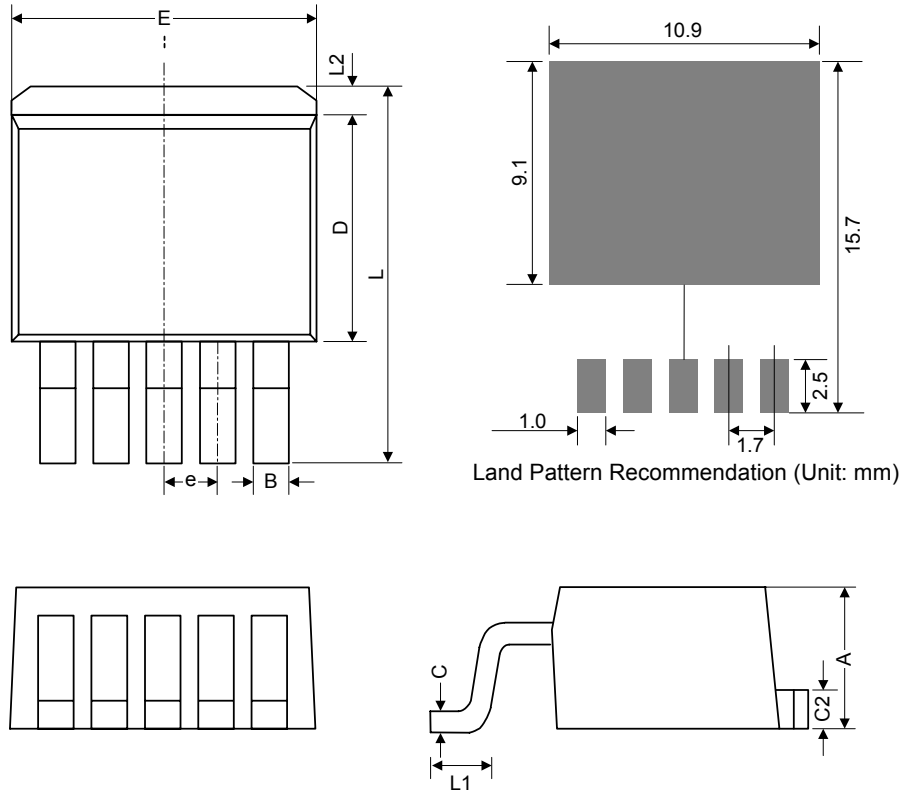

Symbol	Dimensions In Millimeters			Dimensions In Inches		
	Min.	Nom.	Max.	Min.	Nom.	Max.
A	4.07	4.46	4.85	0.160	0.176	0.191
B	0.66	0.84	1.02	0.026	0.033	0.040
C	0.36	0.50	0.64	0.014	0.020	0.025
C2	1.14	1.27	1.40	0.045	0.050	0.055
D	8.65	9.15	9.65	0.341	0.360	0.380
E	9.78	10.16	10.54	0.385	0.400	0.415
e	1.57	1.71	1.85	0.062	0.068	0.073
L	14.61	15.24	15.88	0.575	0.600	0.625
L1	2.29	2.54	2.79	0.090	0.100	0.110
L2	-	-	2.92	-	-	0.115

Not Recommended for New Design



AP1118

1A Positive Low Dropout Fixed-Mode Regulator With EN Function

(4) SOP-8

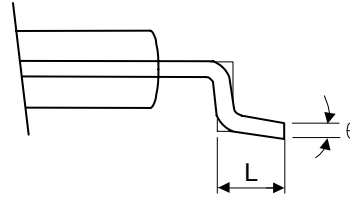
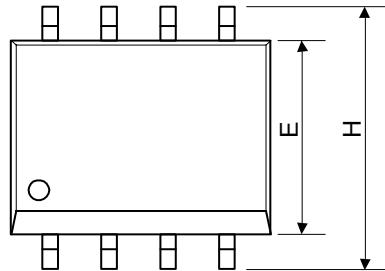

VIEW "A"

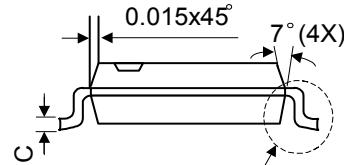
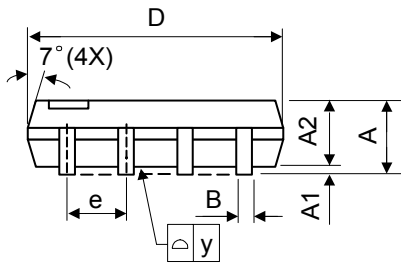

VIEW "A"

Symbol	Dimensions In Millimeters			Dimensions In Inches		
	Min.	Nom.	Max.	Min.	Nom.	Max.
A	1.40	1.60	1.75	0.055	0.063	0.069
A1	0.10	-	0.25	0.040	-	0.100
A2	1.30	1.45	1.50	0.051	0.057	0.059
B	0.33	0.41	0.51	0.013	0.016	0.020
C	0.19	0.20	0.25	0.0075	0.008	0.010
D	4.80	5.05	5.30	0.189	0.199	0.209
E	3.70	3.90	4.10	0.146	0.154	0.161
e	-	1.27	-	-	0.050	-
H	5.79	5.99	6.20	0.228	0.236	0.244
L	0.38	0.71	1.27	0.015	0.028	0.050
y	-	-	0.10	-	-	0.004
θ	0°	-	8°	0°	-	8°

Looking for pricing, stock, or lifecycle information?

Click below to explore more details on WIN SOURCE:

 [View AP1118D90L-13 on WIN SOURCE](#)

 [Diodes Incorporated](#) Information

Optimize Your Supply Chain with WIN SOURCE Solutions

-  Global Sourcing Solution
-  Obsolete Management
-  Cost Control Management
-  Shortage Management
-  Alternative Solution
-  Excess Inventory Management