

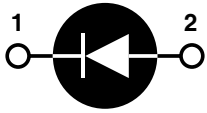

**THE DATASHEET OF
APT60S20SG/TR**





1 - Cathode
2 - Anode
Back of Case - Cathode

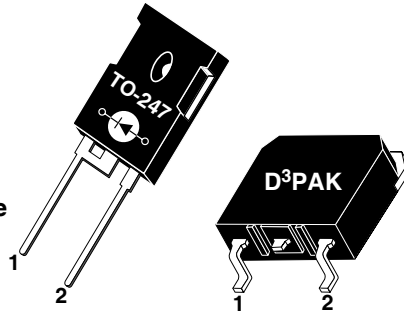

APT60S20B(G) 200V 75A
APT60S20S(G) 200V 75A

HIGH VOLTAGE SCHOTTKY DIODE

PRODUCT APPLICATIONS	PRODUCT FEATURES	PRODUCT BENEFITS
<ul style="list-style-type: none"> Parallel Diode <ul style="list-style-type: none"> -Switchmode Power Supply -Inverters Free Wheeling Diode <ul style="list-style-type: none"> -Motor Controllers -Converters Snubber Diode Uninterruptible Power Supply (UPS) 48 Volt Output Rectifiers High Speed Rectifiers 	<ul style="list-style-type: none"> Ultrafast Recovery Times Soft Recovery Characteristics Popular TO-247 Package or Surface Mount D³PAK Package Low Forward Voltage High Blocking Voltage Low Leakage Current 	<ul style="list-style-type: none"> Low Losses Low Noise Switching Cooler Operation Higher Reliability Systems Increased System Power Density

MAXIMUM RATINGS

All Ratings: $T_C = 25^\circ\text{C}$ unless otherwise specified.

Symbol	Characteristic / Test Conditions	APT60S20B_S(G)	UNIT
V_R	Maximum D.C. Reverse Voltage	200	Volts
V_{RRM}	Maximum Peak Repetitive Reverse Voltage		
V_{RWM}	Maximum Working Peak Reverse Voltage		
$I_F(AV)$	Maximum Average Forward Current ($T_C = 123^\circ\text{C}$, Duty Cycle = 0.5)	75	Amps
$I_F(RMS)$	RMS Forward Current (Square wave, 50% duty)	208	
I_{FSM}	Non-Repetitive Forward Surge Current ($T_J = 45^\circ\text{C}$, 8.3ms)	600	
T_J, T_{STG}	Operating and Storage Temperature Range	-55 to 150	$^\circ\text{C}$
T_L	Lead Temperature for 10 Sec.	300	
E_{VAL}	Avalanche Energy (2A, 30mH)	60	mJ

STATIC ELECTRICAL CHARACTERISTICS

Symbol		MIN	TYP	MAX	UNIT
V_F	Forward Voltage	$I_F = 60\text{A}$.83	.90	Volts
		$I_F = 120\text{A}$.98		
		$I_F = 60\text{A}, T_J = 125^\circ\text{C}$.72		
I_{RM}	Maximum Reverse Leakage Current	$V_R = 200\text{V}$		1	mA
		$V_R = 200\text{V}, T_J = 125^\circ\text{C}$		25	
C_T	Junction Capacitance, $V_R = 200\text{V}$		300		pF

DYNAMIC CHARACTERISTICS

APT60S20B_S(G)

Symbol	Characteristic	Test Conditions	MIN	TYP	MAX	UNIT
t_{rr}	Reverse Recovery Time	$I_F = 60A, di_F/dt = -200A/\mu s$ $V_R = 133V, T_C = 25^\circ C$	-	55		ns
Q_{rr}	Reverse Recovery Charge		-	160		nC
I_{RRM}	Maximum Reverse Recovery Current		-	5	-	Amps
t_{rr}	Reverse Recovery Time	$I_F = 60A, di_F/dt = -200A/\mu s$ $V_R = 133V, T_C = 125^\circ C$	-	100		ns
Q_{rr}	Reverse Recovery Charge		-	490		nC
I_{RRM}	Maximum Reverse Recovery Current		-	10	-	Amps
t_{rr}	Reverse Recovery Time	$I_F = 60A, di_F/dt = -700A/\mu s$ $V_R = 133V, T_C = 125^\circ C$	-	80		ns
Q_{rr}	Reverse Recovery Charge		-	1100		nC
I_{RRM}	Maximum Reverse Recovery Current		-	27		Amps

THERMAL AND MECHANICAL CHARACTERISTICS

Symbol	Characteristic / Test Conditions	MIN	TYP	MAX	UNIT
$R_{\theta JC}$	Junction-to-Case Thermal Resistance			.30	$^\circ C/W$
$R_{\theta JA}$	Junction-to-Ambient Thermal Resistance			40	
W_T	Package Weight		0.22		oz
			5.9		g
Torque	Maximum Mounting Torque			10	lb•in
				1.1	N•m

Microsemi reserves the right to change, without notice, the specifications and information contained herein.

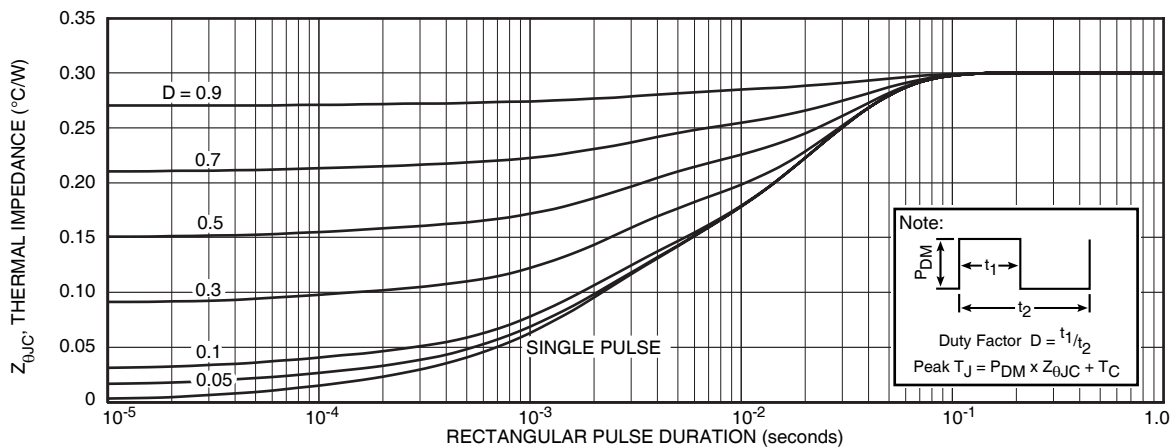
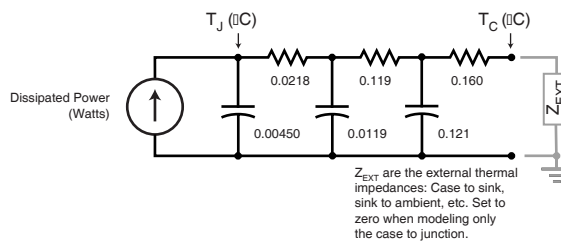

FIGURE 1a. MAXIMUM EFFECTIVE TRANSIENT THERMAL IMPEDANCE, JUNCTION-TO-CASE vs. PULSE DURATION



Z_{EXT} are the external thermal impedances: Case to sink, sink to ambient, etc. Set to zero when modeling only the case to junction.

FIGURE 1b. TRANSIENT THERMAL IMPEDANCE MODEL

TYPICAL PERFORMANCE CURVES

APT60S20B_S(G)

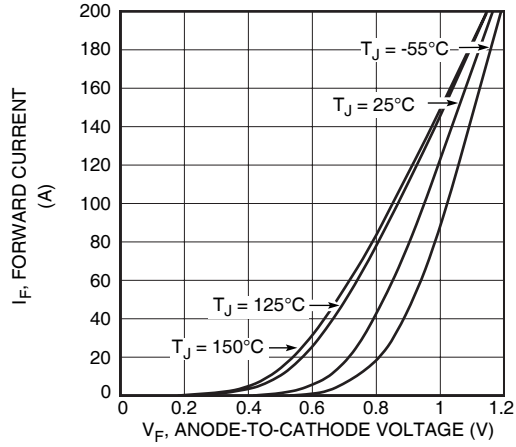

Figure 2. Forward Current vs. Forward Voltage

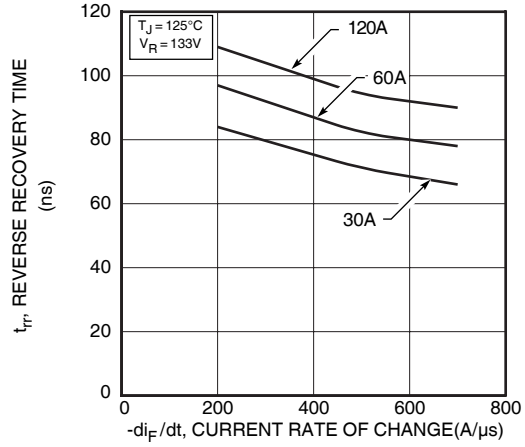

Figure 3. Reverse Recovery Time vs. Current Rate of Change

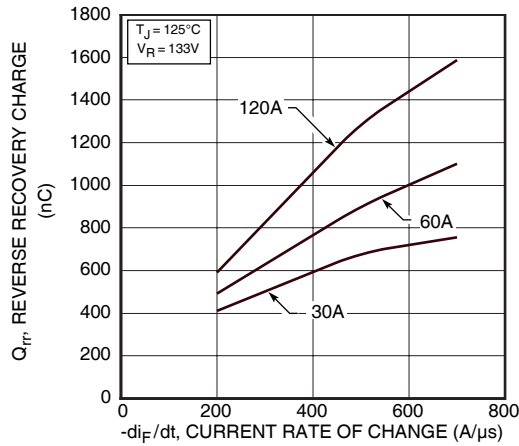

Figure 4. Reverse Recovery Charge vs. Current Rate of Change

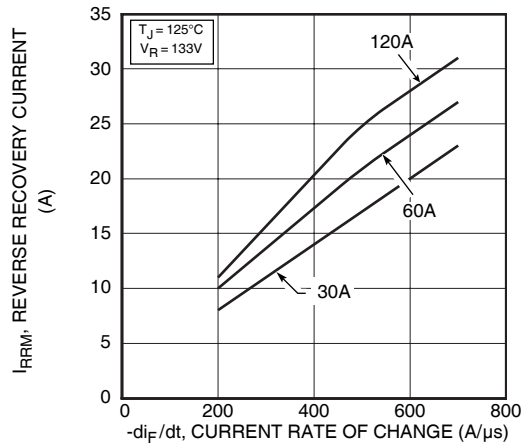

Figure 5. Reverse Recovery Current vs. Current Rate of Change

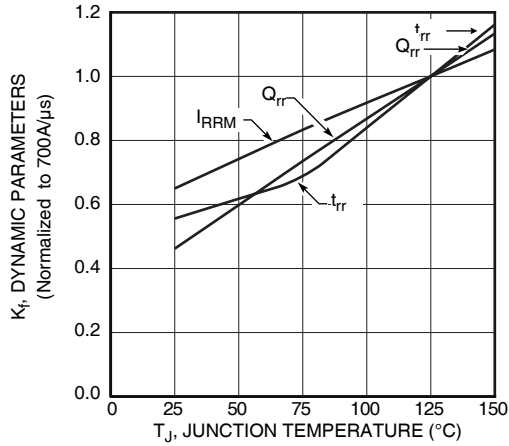

Figure 6. Dynamic Parameters vs. Junction Temperature

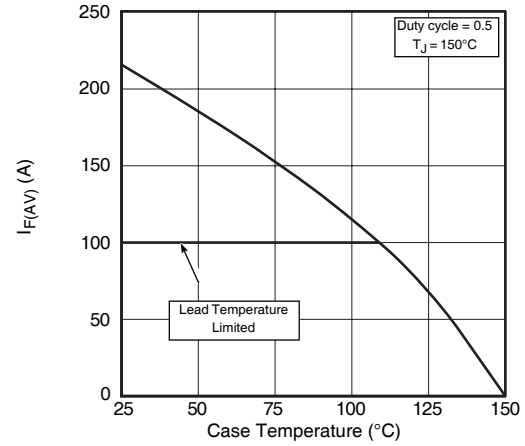

Figure 7. Maximum Average Forward Current vs. Case Temperature

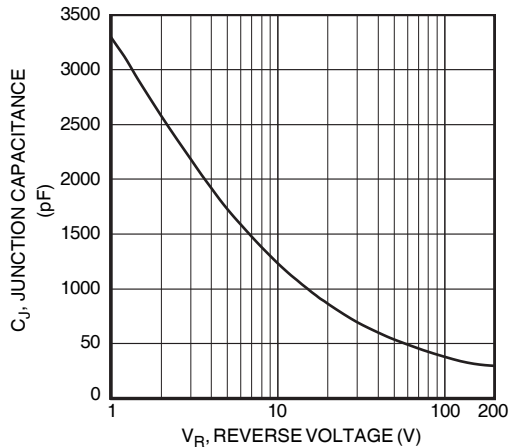

Figure 8. Junction Capacitance vs. Reverse Voltage

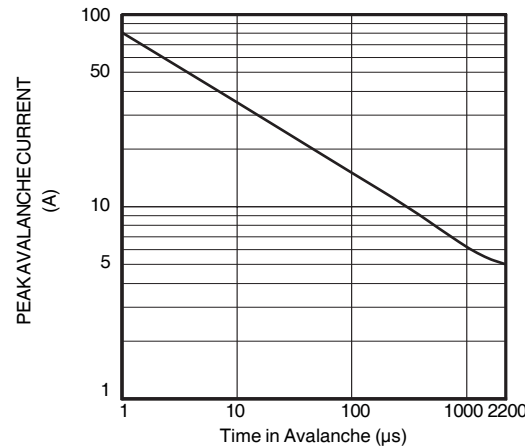

Figure 9. Single Pulse UIS SOA

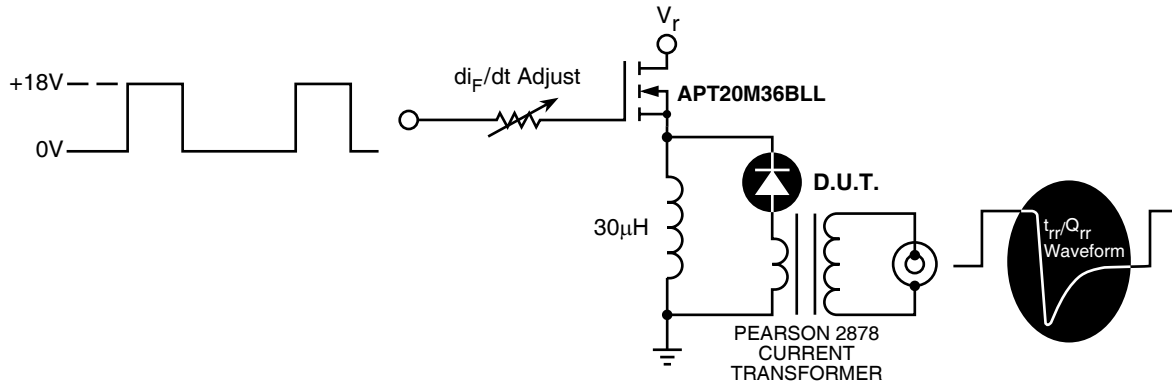

Figure 9. Diode Test Circuit

- 1 I_F - Forward Conduction Current
- 2 di_F/dt - Rate of Diode Current Change Through Zero Crossing.
- 3 I_{RRM} - Maximum Reverse Recovery Current.
- 4 t_{rr} - Reverse Recovery Time, measured from zero crossing where diode current goes from positive to negative, to the point at which the straight line through I_{RRM} and $0.25 \cdot I_{RRM}$ passes through zero.
- 5 Q_{rr} - Area Under the Curve Defined by I_{RRM} and t_{rr} .

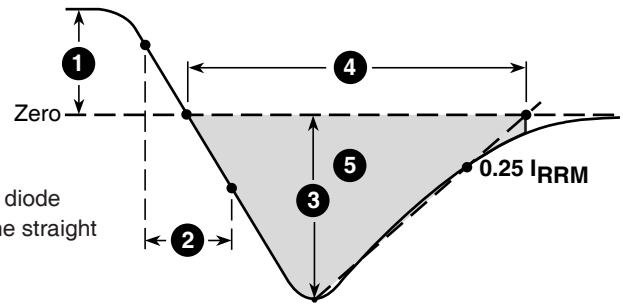
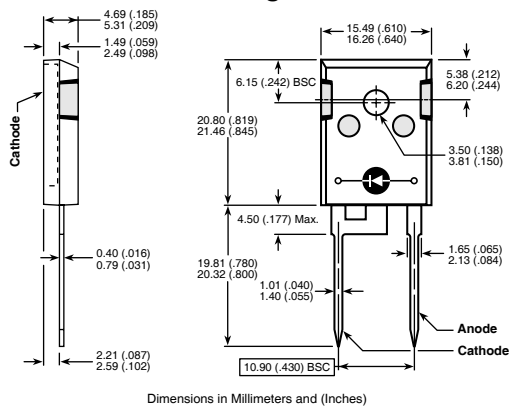
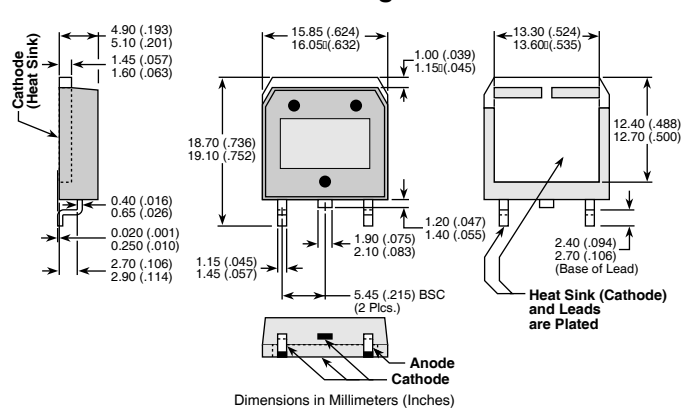

Figure 10, Diode Reverse Recovery Waveform and Definitions

TO-247 Package Outline



D³PAK Package Outline



Looking for pricing, stock, or lifecycle information?

Click below to explore more details on WIN SOURCE:

- ⊖ [View APT60S20SG/TR on WIN SOURCE](#)
- ⊖ [Microsemi Corporation](#) Information

Optimize Your Supply Chain with WIN SOURCE Solutions

- ✓ Global Sourcing Solution
- ✓ Obsolete Management
- ✓ Cost Control Management
- ✓ Shortage Management
- ✓ Alternative Solution
- ✓ Excess Inventory Management