



**THE DATASHEET OF
ATS276H-PG-B-C**



Features

- On-Chip Hall Sensor with Two Different Sensitivity and Hysteresis Settings for ATS276
- 3.5V to 20V Operating Voltage
- 400mA (avg.) Output Sink Current
- Built-in Protecting Diode Only for Chip Reverse Power Connecting
- -20°C to 85°C Operating Temperature
- Low Profile 4 Pin SIP Package
- Lead Free package: SIP-4L
- SIP-4L: Available in "Green" Molding Compound (No Br, Sb)
- Lead Free Finish/RoHS Compliant (Note 1)

General Description

ATS276 are integrated Hall sensors with output drivers, mainly designed for electronic commutation of brush-less DC Fan. This IC internally includes the regulator, protecting diode, Hall plate, amplifier, comparator, and a pair of complementary open-collector outputs (**DO**, **DOB**).

While the magnetic flux density (**B**) is larger than operate point (**Bop**), **DO** will turn on (low), and meanwhile **DOB** will turn off (high). Each output is latched until **B** is lower than release point (**Brp**), and then **DO**, **DOB** transfer each state.

For DC fan application, sometimes need to test power reverse connection condition. Internal diode only protects chip-side but not for coil-side. If necessary, add one external diode to block the reverse current from coil-side.

Applications

- Dual-Coil Brush-Less DC Motor
- Dual-Coil Brush-Less DC Fan
- Revolution Counting
- Speed Measurement

Ordering Information

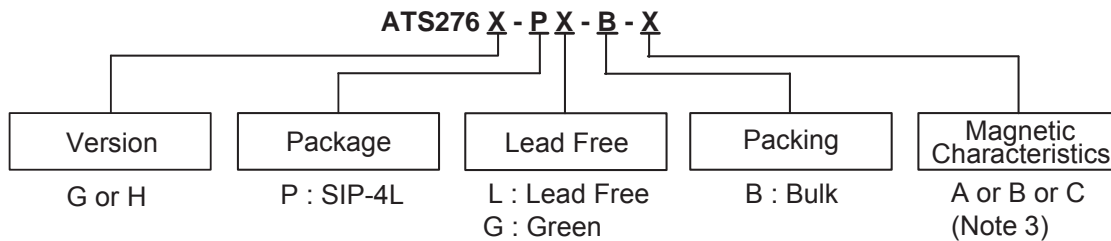

Device	Package Code	Packaging (Note 2)	Bulk		Magnetic Characteristics
			Quantity	Part Number Suffix	
ATS276G-PL-B-A	P	SIP-4L	1000	-B	A
S276G-PL-B-B	P	SIP-4L	1000	-B	B
ATS276G-PL-B-C	P	SIP-4L	1000	-B	C
ATS276H-PL-B-A	P	SIP-4L	1000	-B	A
ATS276H-PL-B-B	P	SIP-4L	1000	-B	B
ATS276H-PG-B-A	P	SIP-4L	1000	-B	A
TS276H-PG-B-B	P	SIP-4L	1000	-B	B

- Notes:
1. EU Directive 2002/95/EC (RoHS). All applicable RoHS exemptions applied, see *EU Directive 2002/95/EC Annex Notes*.
 2. Pad layout as shown on Diodes Inc. suggested pad layout document AP02001, which can be found on our website at <http://www.diodes.com/datasheets/ap02001.pdf>.
 3. Please refer to page 5 (Magnetic Characteristics table).

Pin Assignments

(Top View)

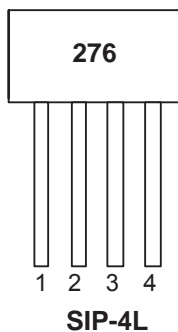

Pin Descriptions

Name	P/I/O	Pin #	Description
V _{cc}	P	1	Power Supply Input
DO	O	2	Output Pin
DOB	O	3	Output Pin
GND	P	4	Ground

Block Diagram

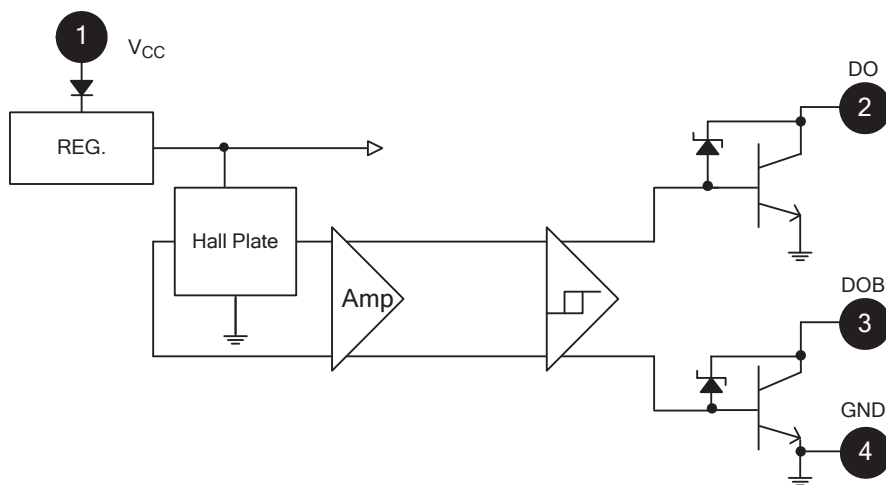

Typical Application Circuit

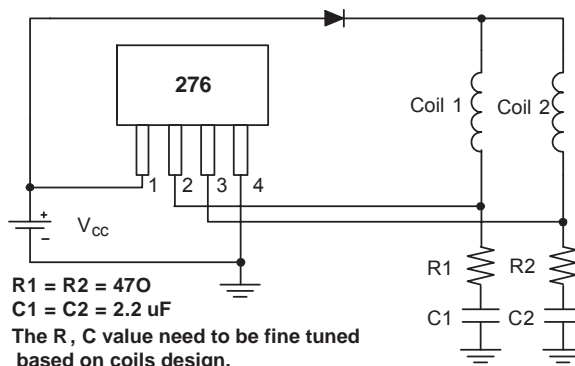

Brush-Less DC Fan

Absolute Maximum Ratings (T_A = 25°C)

Symbol	Characteristics	Values	Unit
V _{CC}	Supply Voltage	20	V
V _{RCC}	Reverse V _{CC} Polarity Voltage	-20	V
B	Magnetic Flux Density	Unlimited	
I _c	Output "on" Current	Continuous	0.4
		Hold	0.5
		Peak (Start Up)	0.7
T _S	Storage Temperature Range	-65~+150	°C
P _D	Package Power Dissipation	550	mW
T _J	Maximum Junction Temperature	150	°C

Recommended Operating Conditions

Symbol	Characteristic	Conditions	Min	Max	Unit
V _{CC}	Supply Voltage (Note 4)	Operating	3.5	20	V
T _A	Operating Ambient Temperature (Note 5)	Operating	-20	85	°C

Notes: 4. The output DO/DOB is switching as magnetic field change (S>300G, N<-300G).
5. Shall not exceed P_D and Safety Operation Area.

Electrical Characteristics (T_A = +25°C, V_{CC} = 4.0V to 20V)

Symbol	Characteristic	Conditions	Min	Typ.	Max	Units
V _{ce}	Low Supply Voltage	V _{CC} = 3.5V, I _L = 100mA		0.4		V
V _Z	Output Zener Breakdown	(Note 6)		46		V
V _{ce(SAT)}	Output Saturation Voltage	V _{CC} = 14V, I _L = 300mA		0.3	0.6	V
I _{ceX}	Output Leakage Current	V _{ce} = 14V, V _{CC} = 14V		<0.1	10	μA
I _{CC}	Supply Current	V _{CC} = 20V, Output Open		16	25	mA
t _r	Output Rise Time	V _{CC} = 14V, R _L = 820Ω, C _L = 20pF		3.0	10	μs
t _f	Output Falling Time	V _{CC} = 14V, R _L = 820Ω, C _L = 20pF		0.3	1.5	μs
Δt	Switch Time Differential	V _{CC} = 14V, R _L = 820Ω, C _L = 20pF		3.0	10	μs

Notes: 6. The V_Z may vary with the inductance/resistance of DC Fan. In order to reduce the risk of dynamic operation, the capacitor/ resistor is recommended to add below the DO/DOB as Application Circuit (see General Description on page 1).

Test Circuit

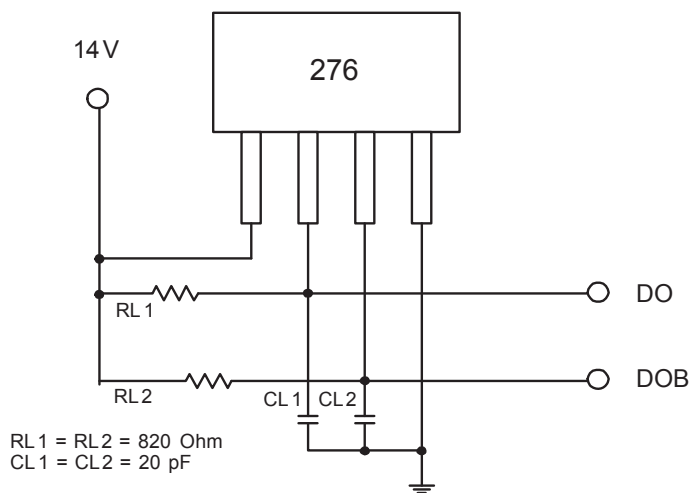

Magnetic Characteristics ($T_A = +25^\circ\text{C}$, $V_{CC} = 14\text{V}$)

(1mT = 10 Gauss)

A grade

Symbol	Characteristic	Min	Typ.	Max	Unit
Bop	Operation Point	10	-	50	Gauss
Brp	Release Point	-50	-	-10	Gauss
Bhy	Hysteresis	-	75	-	Gauss

B grade

Symbol	Characteristic	Min	Typ.	Max	Unit
Bop	Operation Point	5	-	70	Gauss
Brp	Release Point	-70	-	-5	Gauss
Bhy	Hysteresis	-	75	-	Gauss

C grade

Symbol	Characteristic	Min	Typ.	Max	Unit
Bop	Operation Point	-	-	100	Gauss
Brp	Release Point	-100	-	-	Gauss
Bhy	Hysteresis	-	75	-	Gauss

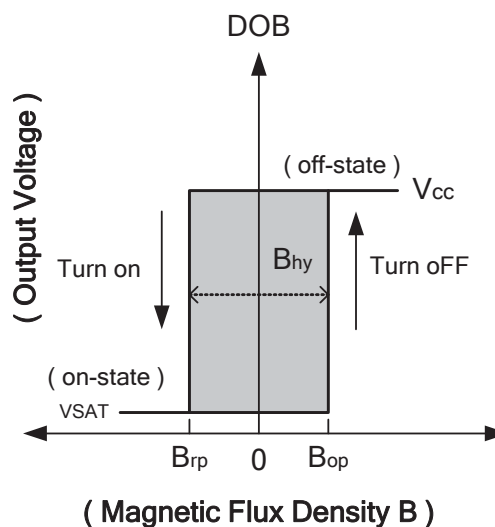
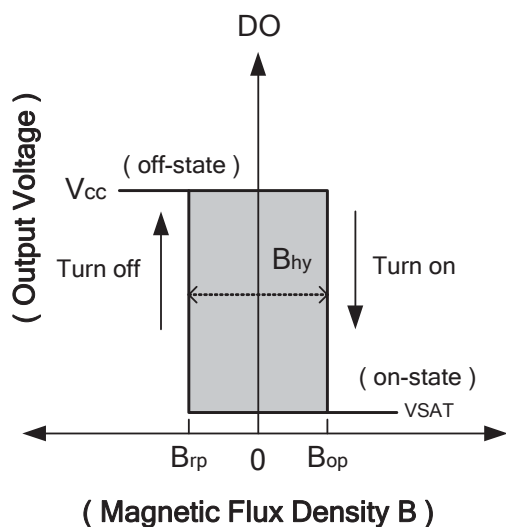

Operating Characteristics

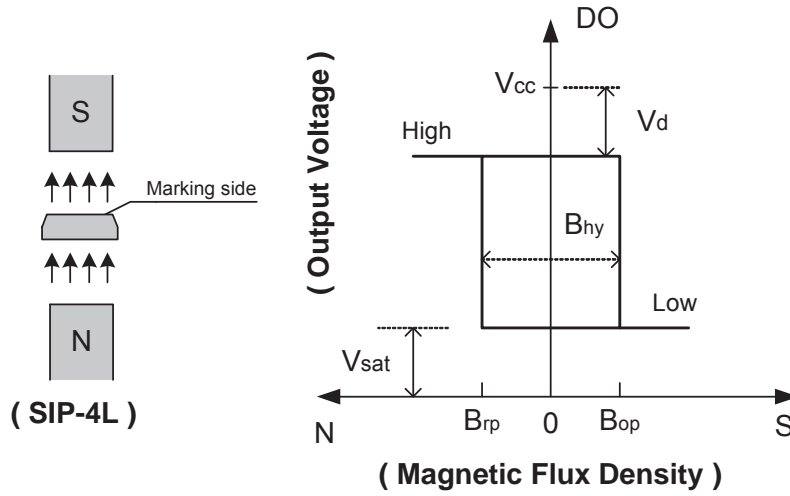

Performance Characteristics

T_A (°C)	25	50	60	70	80	85	90	95	100
P_D (mW)	550	440	396	352	308	286	264	242	220
T_A (°C)	105	110	115	120	125	130	135	140	150
P_D (mW)	198	176	154	132	110	88	66	44	0

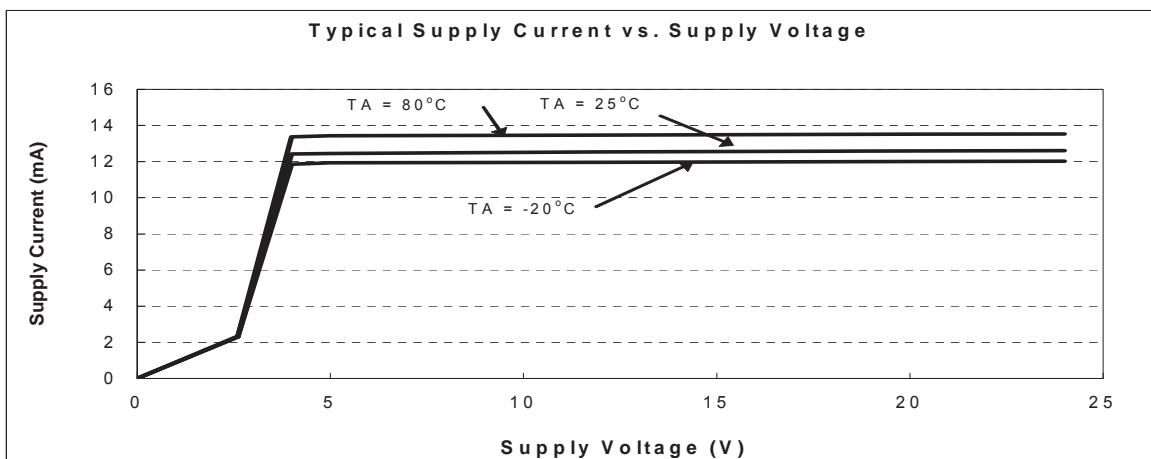
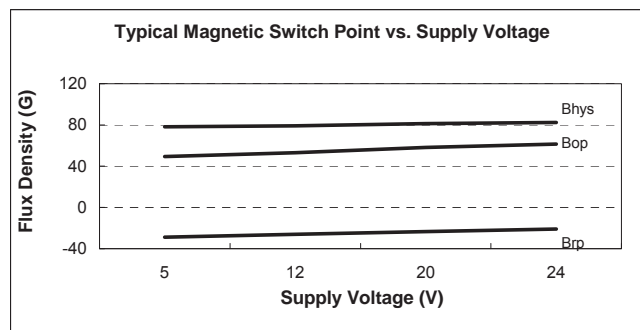
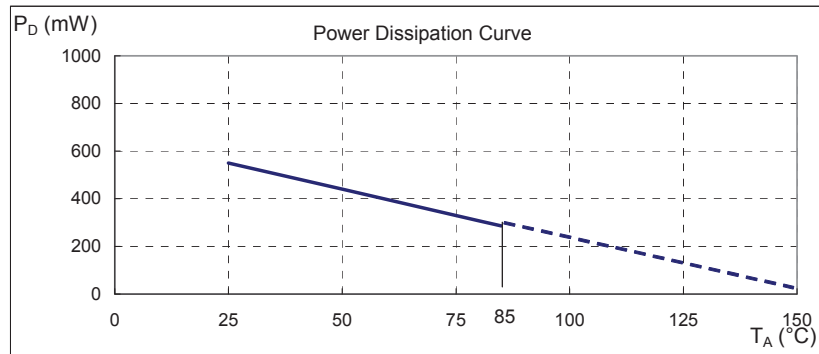

Marking Information

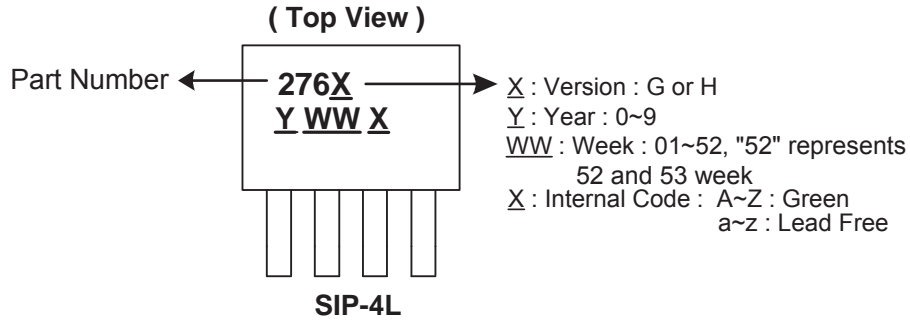

Package Information (All Dimensions in mm)

Active Area Depth

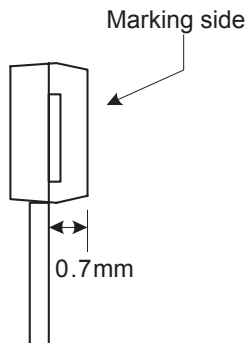

Package Sensor Location

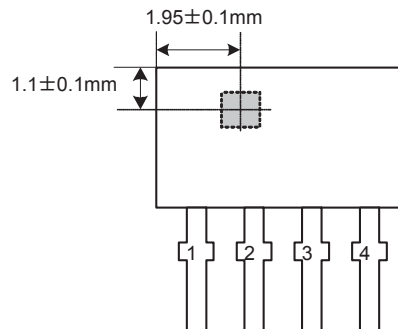

Package Dimension

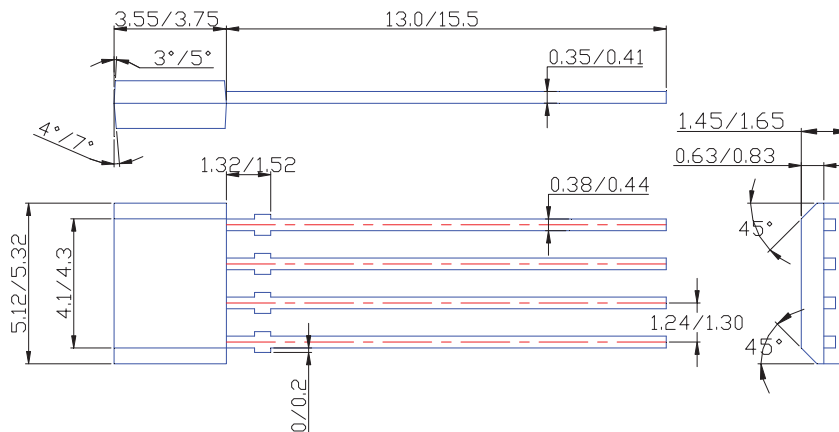

IMPORTANT NOTICE



Diodes Incorporated and its subsidiaries reserve the right to make modifications, enhancements, improvements, corrections or other changes without further notice to any product herein. Diodes Incorporated does not assume any liability arising out of the application or use of any product described herein; neither does it convey any license under its patent rights, nor the rights of others. The user of products in such applications shall assume all risks of such use and will agree to hold Diodes Incorporated and all the companies whose products are represented on our website, harmless against all damages.

LIFE SUPPORT

Diodes Incorporated products are not authorized for use as critical components in life support devices or systems without the expressed written approval of the President of Diodes Incorporated.

Looking for pricing, stock, or lifecycle information?

Click below to explore more details on WIN SOURCE:

-  [View AT276H-PG-B-C on WIN SOURCE](#)
-  [Diodes Incorporated Information](#)

Optimize Your Supply Chain with WIN SOURCE Solutions

-  Global Sourcing Solution
-  Obsolete Management
-  Cost Control Management
-  Shortage Management
-  Alternative Solution
-  Excess Inventory Management