

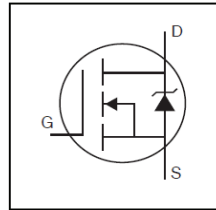


**THE DATASHEET OF  
AUIRFS3306TRL**

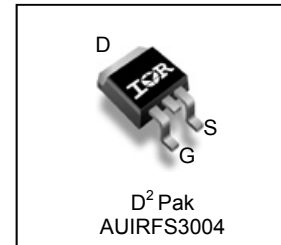


**Features**

- Advanced Process Technology
- Ultra Low On-Resistance
- 175°C Operating Temperature
- Fast Switching
- Repetitive Avalanche Allowed up to Tjmax
- Lead-Free, RoHS Compliant
- Automotive Qualified \*



<b>V<sub>DSS</sub></b>	<b>60V</b>
<b>R<sub>DS(on)</sub> typ.</b>	<b>3.3mΩ</b>
	<b>4.2mΩ</b>
<b>I<sub>D</sub> (Silicon Limited)</b>	<b>160A<sup>①</sup></b>
<b>I<sub>D</sub> (Package Limited)</b>	<b>120A</b>



<b>G</b>	<b>D</b>	<b>S</b>
Gate	Drain	Source

**Description**

Specifically designed for Automotive applications, this HEXFET® Power MOSFET utilizes the latest processing techniques to achieve extremely low on-resistance per silicon area. Additional features of this design are a 175°C junction operating temperature, fast switching speed and improved repetitive avalanche rating. These features combine to make this design an extremely efficient and reliable device for use in Automotive applications and a wide variety of other applications.

Base part number	Package Type	Standard Pack		Orderable Part Number
		Form	Quantity	
AUIRFS3306	D <sup>2</sup> -Pak	Tube	50	AUIRFS3306
		Tape and Reel Left	800	AUIRFS3306TRL

**Absolute Maximum Ratings**

Stresses beyond those listed under “Absolute Maximum Ratings” may cause permanent damage to the device. These are stress ratings only; and functional operation of the device at these or any other condition beyond those indicated in the specifications is not implied. Exposure to absolute-maximum-rated conditions for extended periods may affect device reliability. The thermal resistance and power dissipation ratings are measured under board mounted and still air conditions. Ambient temperature (TA) is 25°C, unless otherwise specified.

Symbol	Parameter	Max.	Units
I <sub>D</sub> @ T <sub>C</sub> = 25°C	Continuous Drain Current, V <sub>GS</sub> @ 10V (Silicon Limited)	160 <sup>①</sup>	A
I <sub>D</sub> @ T <sub>C</sub> = 100°C	Continuous Drain Current, V <sub>GS</sub> @ 10V (Silicon Limited)	110 <sup>①</sup>	
I <sub>D</sub> @ T <sub>C</sub> = 25°C	Continuous Drain Current, V <sub>GS</sub> @ 10V (Wire Bond Limited)	120	
I <sub>DM</sub>	Pulsed Drain Current <sup>②</sup>	620	
P <sub>D</sub> @ T <sub>C</sub> = 25°C	Maximum Power Dissipation	230	W
	Linear Derating Factor	1.5	W/°C
V <sub>GS</sub>	Gate-to-Source Voltage	± 20	V
E <sub>AS</sub>	Single Pulse Avalanche Energy (Thermally Limited) <sup>③</sup>	184	mJ
I <sub>AR</sub>	Avalanche Current <sup>②</sup>	See Fig.14,15, 22a, 22b	A
E <sub>AR</sub>	Repetitive Avalanche Energy <sup>②</sup>		mJ
dv/dt	Peak Diode Recovery <sup>④</sup>	14	V/ns
T <sub>J</sub>	Operating Junction and	-55 to + 175	°C
T <sub>STG</sub>	Storage Temperature Range		
	Soldering Temperature, for 10 seconds (1.6mm from case)	300	

**Thermal Resistance**

Symbol	Parameter	Typ.	Max.	Units
R <sub>θJC</sub>	Junction-to-Case <sup>⑤</sup>	—	0.65	°C/W
R <sub>θJA</sub>	Junction-to-Ambient (PCB Mount) <sup>⑤</sup>	—	40	

HEXFET® is a registered trademark of Infineon.

\*Qualification standards can be found at [www.infineon.com](http://www.infineon.com)

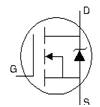
**Static @ T<sub>J</sub> = 25°C (unless otherwise specified)**

	Parameter	Min.	Typ.	Max.	Units	Conditions
V <sub>(BR)DSS</sub>	Drain-to-Source Breakdown Voltage	60	—	—	V	V <sub>GS</sub> = 0V, I <sub>D</sub> = 250μA
ΔV <sub>(BR)DSS</sub> /ΔT <sub>J</sub>	Breakdown Voltage Temp. Coefficient	—	0.07	—	V/°C	Reference to 25°C, I <sub>D</sub> = 5mA ②
R <sub>DS(on)</sub>	Static Drain-to-Source On-Resistance	—	3.3	4.2	mΩ	V <sub>GS</sub> = 10V, I <sub>D</sub> = 75A ⑤
V <sub>GS(th)</sub>	Gate Threshold Voltage	2.0	—	4.0	V	V <sub>DS</sub> = V <sub>GS</sub> , I <sub>D</sub> = 150μA
g <sub>fs</sub>	Forward Trans conductance	230	—	—	S	V <sub>DS</sub> = 50V, I <sub>D</sub> = 75A
R <sub>G</sub>	Internal Gate Resistance	—	0.7	—	Ω	
I <sub>DSS</sub>	Drain-to-Source Leakage Current	—	—	20	μA	V <sub>DS</sub> = 60V, V <sub>GS</sub> = 0V
		—	—	250		V <sub>DS</sub> = 48V, V <sub>GS</sub> = 0V, T <sub>J</sub> = 125°C
I <sub>GSS</sub>	Gate-to-Source Forward Leakage	—	—	100	nA	V <sub>GS</sub> = 20V
	Gate-to-Source Reverse Leakage	—	—	-100		V <sub>GS</sub> = -20V

**Dynamic Electrical Characteristics @ T<sub>J</sub> = 25°C (unless otherwise specified)**

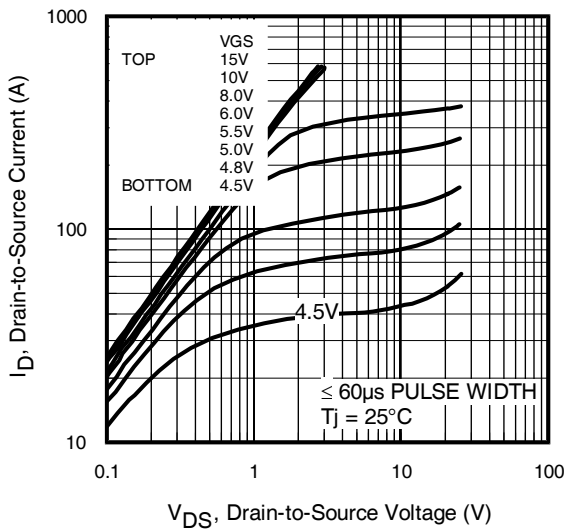
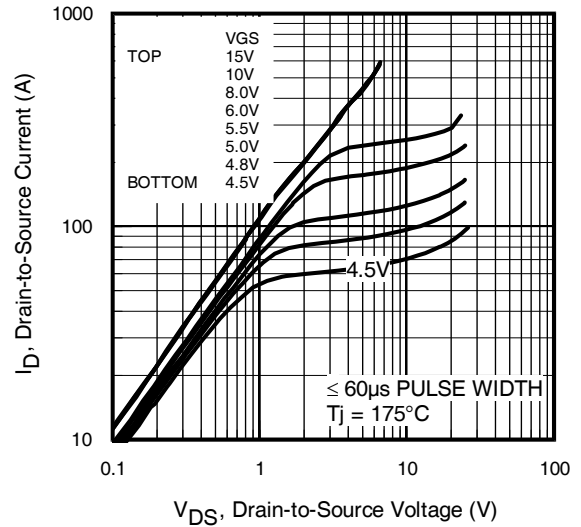
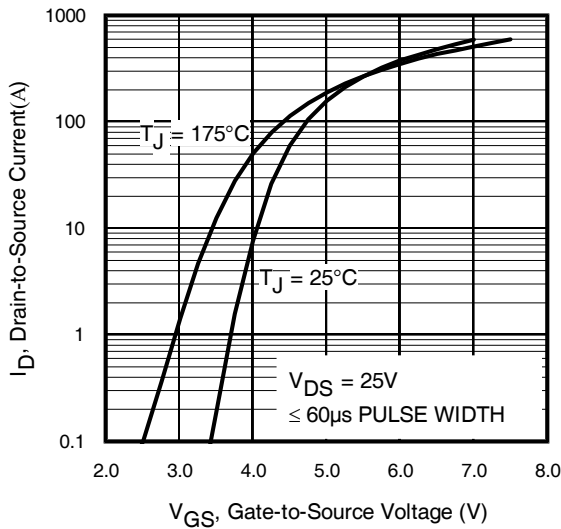
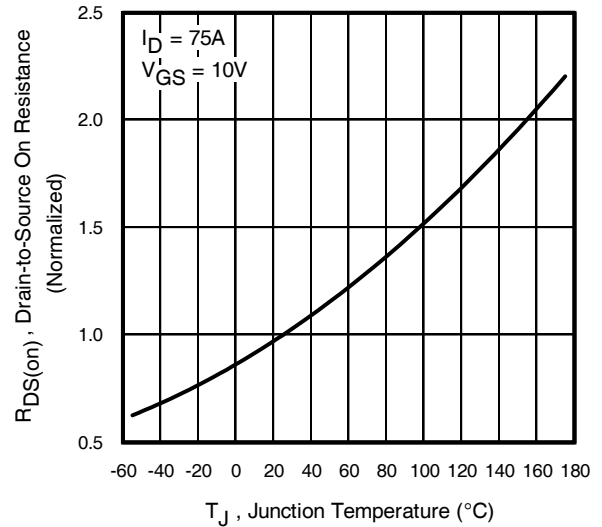
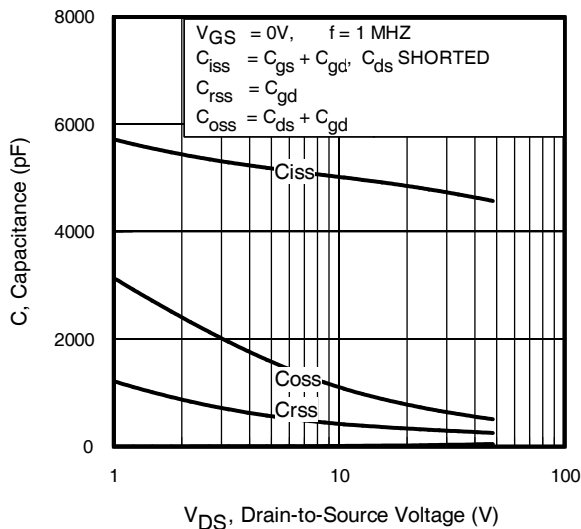
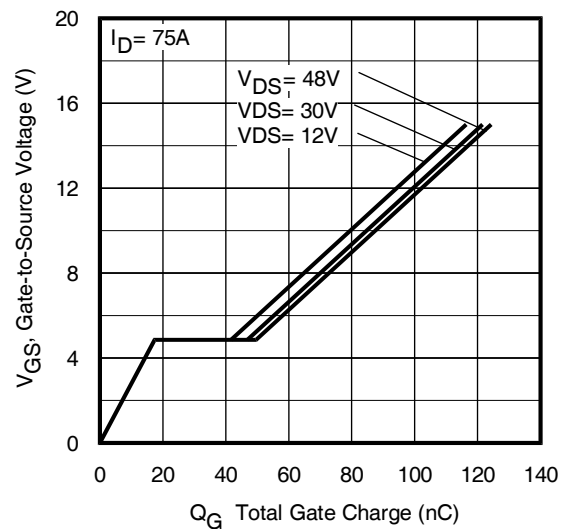
Q <sub>g</sub>	Total Gate Charge	—	85	120	nC	I <sub>D</sub> = 75A V <sub>DS</sub> = 30V V <sub>GS</sub> = 10V ⑤
Q <sub>gs</sub>	Gate-to-Source Charge	—	20	—		
Q <sub>gd</sub>	Gate-to-Drain Charge	—	26	—		
Q <sub>sync</sub>	Total Gate Charge Sync. (Q <sub>g</sub> - Q <sub>gd</sub> )	—	59	—		
t <sub>d(on)</sub>	Turn-On Delay Time	—	15	—	ns	V <sub>DD</sub> = 30V I <sub>D</sub> = 75A R <sub>G</sub> = 2.7Ω V <sub>GS</sub> = 10V ⑤
t <sub>r</sub>	Rise Time	—	76	—		
t <sub>d(off)</sub>	Turn-Off Delay Time	—	40	—		
t <sub>f</sub>	Fall Time	—	77	—		
C <sub>iss</sub>	Input Capacitance	—	4520	—	pF	V <sub>GS</sub> = 0V V <sub>DS</sub> = 50V f = 1.0MHz, See Fig. 5
C <sub>oss</sub>	Output Capacitance	—	500	—		
C <sub>rss</sub>	Reverse Transfer Capacitance	—	250	—		
C <sub>oss eff.(ER)</sub>	Effective Output Capacitance (Energy Related)	—	720	—		
C <sub>oss eff.(TR)</sub>	Effective Output Capacitance (Time Related)	—	880	—		

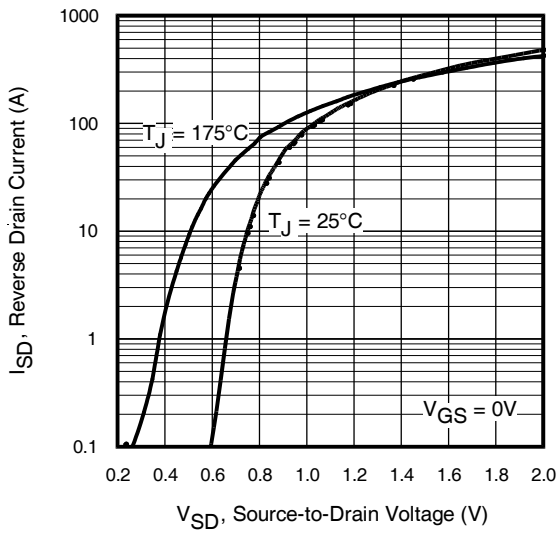
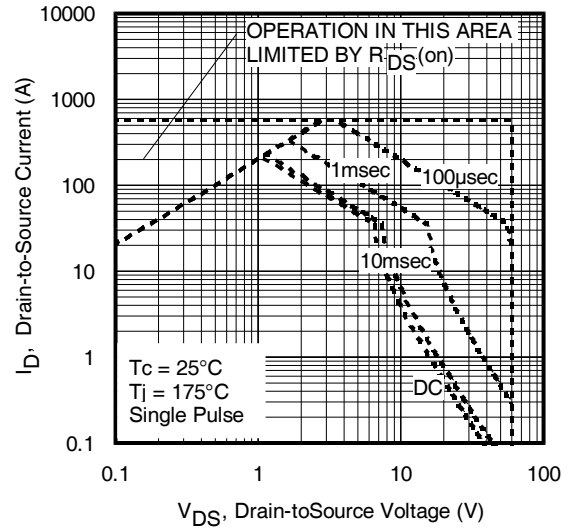
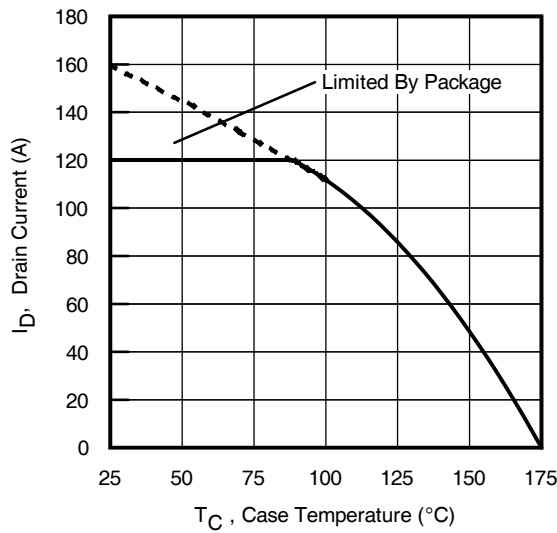
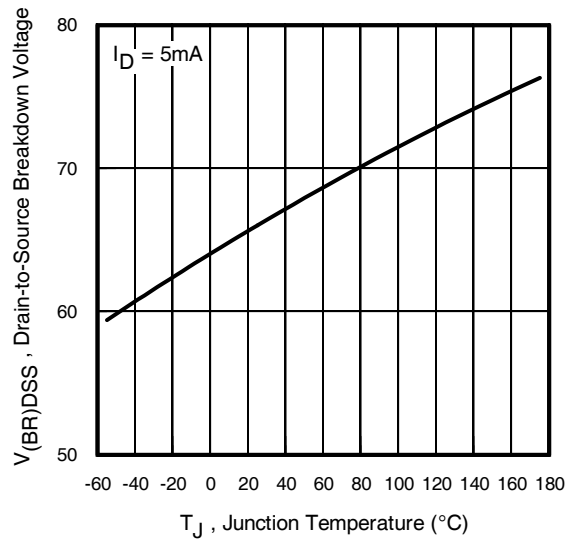
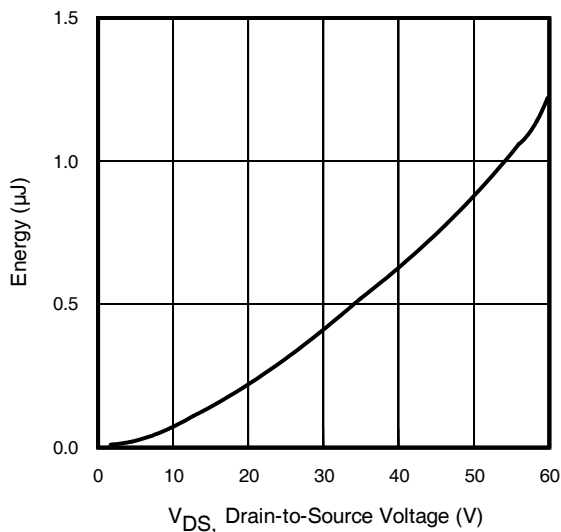
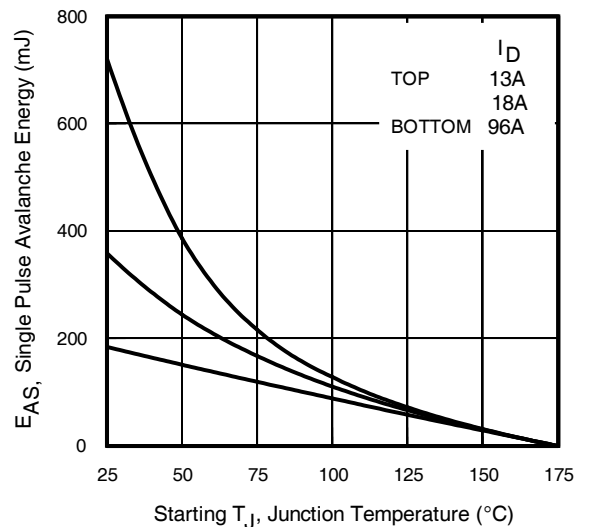
**Diode Characteristics**

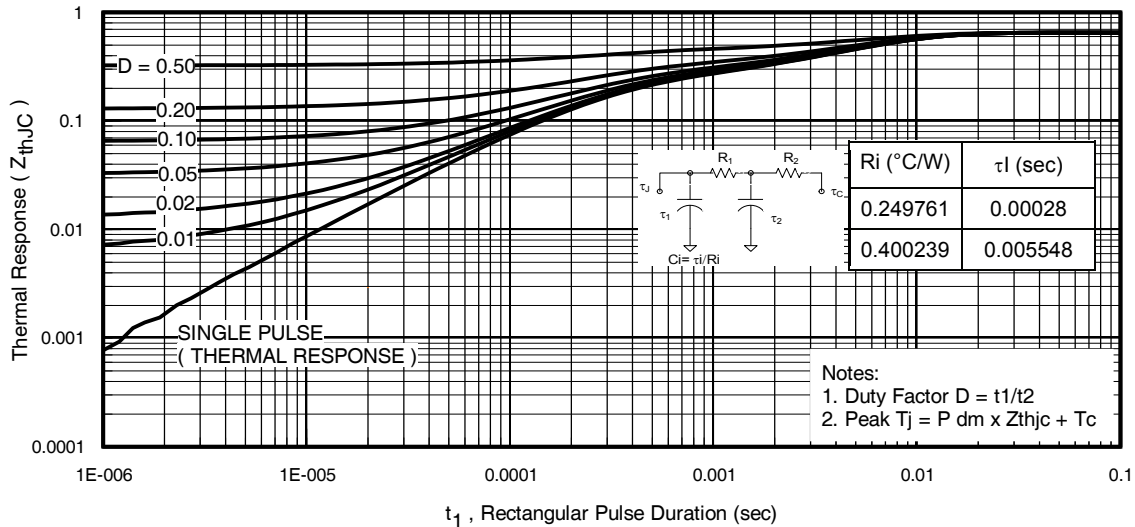
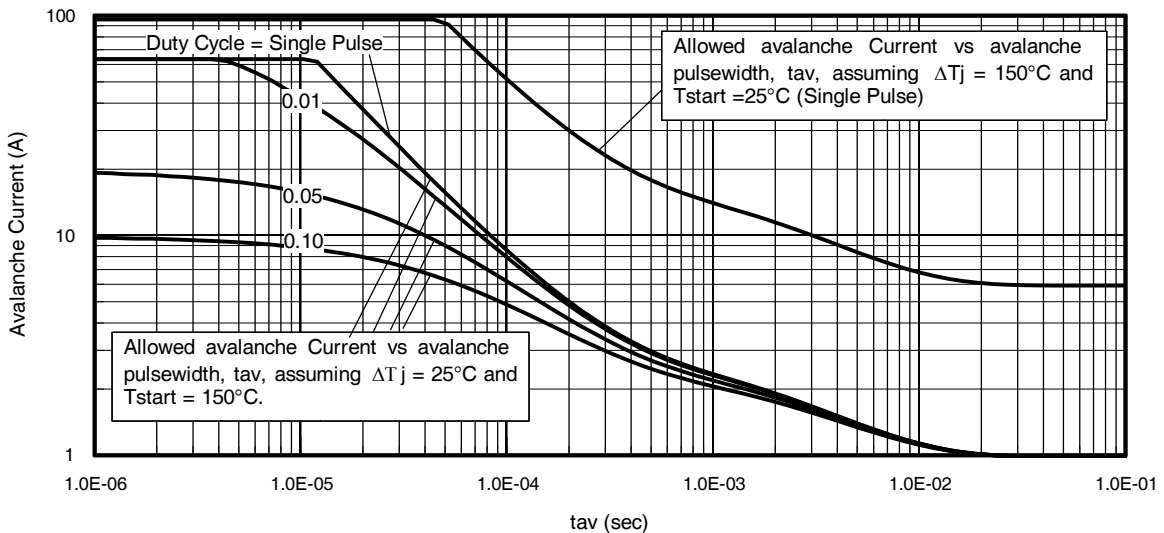
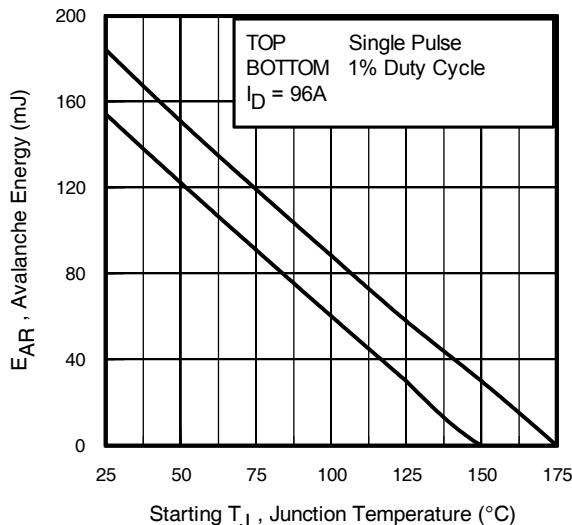
	Parameter	Min.	Typ.	Max.	Units	Conditions
I <sub>S</sub>	Continuous Source Current (Body Diode)	—	—	160 ①	A	MOSFET symbol showing the integral reverse p-n junction diode. 
I <sub>SM</sub>	Pulsed Source Current (Body Diode) ②	—	—	620		
V <sub>SD</sub>	Diode Forward Voltage	—	—	1.3	V	T <sub>J</sub> = 25°C, I <sub>S</sub> = 75A, V <sub>GS</sub> = 0V ③
t <sub>rr</sub>	Reverse Recovery Time	—	31	—	ns	T <sub>J</sub> = 25°C
		—	35	—		T <sub>J</sub> = 125°C
Q <sub>rr</sub>	Reverse Recovery Charge	—	34	—	nC	T <sub>J</sub> = 25°C
		—	45	—		T <sub>J</sub> = 125°C
I <sub>RRM</sub>	Reverse Recovery Current	—	1.9	—	A	T <sub>J</sub> = 25°C
t <sub>on</sub>	Forward Turn-On Time	Intrinsic turn-on time is negligible (turn-on is dominated by L <sub>S</sub> +L <sub>D</sub> )				

**Notes:**

- ① Calculated continuous current based on maximum allowable junction temperature. Bond wire current limit is 120A. Note that current limitations arising from heating of the device leads may occur with some lead mounting arrangements.
- ② Repetitive rating; pulse width limited by max. junction temperature.
- ③ Limited by T<sub>Jmax</sub>, starting T<sub>J</sub> = 25°C, L = 0.04mH, R<sub>G</sub> = 25Ω, I<sub>AS</sub> = 96A, V<sub>GS</sub> = 10V. Part not recommended for use above this value.
- ④ I<sub>SD</sub> ≤ 75A, di/dt ≤ 1400A/μs, V<sub>DD</sub> ≤ V<sub>(BR)DSS</sub>, T<sub>J</sub> ≤ 175°C.
- ⑤ Pulse width ≤ 400μs; duty cycle ≤ 2%.
- ⑥ C<sub>oss eff. (TR)</sub> is a fixed capacitance that gives the same charging time as C<sub>oss</sub> while V<sub>DS</sub> is rising from 0 to 80% V<sub>DSS</sub>.
- ⑦ C<sub>oss eff. (ER)</sub> is a fixed capacitance that gives the same energy as C<sub>oss</sub> while V<sub>DS</sub> is rising from 0 to 80% V<sub>DSS</sub>.
- ⑧ When mounted on 1" square PCB (FR-4 or G-10 Material). For recommended footprint and soldering techniques refer to application note #AN-994
- ⑨ R<sub>θ</sub> is measured at T<sub>J</sub> approximately 90°C.


**Fig. 1** Typical Output Characteristics

**Fig. 2** Typical Output Characteristics

**Fig. 3** Typical Transfer Characteristics

**Fig. 4** Normalized On-Resistance vs. Temperature

**Fig. 5.** Typical Capacitance vs. Drain-to-Source Voltage

**Fig. 6.** Typical Gate Charge vs. Gate-to-Source Voltage


**Fig. 7** Typical Source-to-Drain Diode

**Fig. 8.** Maximum Safe Operating Area

**Fig. 9.** Maximum Drain Current vs. Case Temperature

**Fig. 10.** Drain-to-Source Breakdown Voltage

**Fig. 11.** Typical Coss Stored Energy

**Fig. 12.** Maximum Avalanche Energy vs. Drain Current


**Fig 13. Maximum Effective Transient Thermal Impedance, Junction-to-Case**

**Fig 14. Avalanche Current vs. Pulse width**

**Notes on Repetitive Avalanche Curves , Figures 14, 15:  
 (For further info, see AN-1005 at www.infineon.com)**

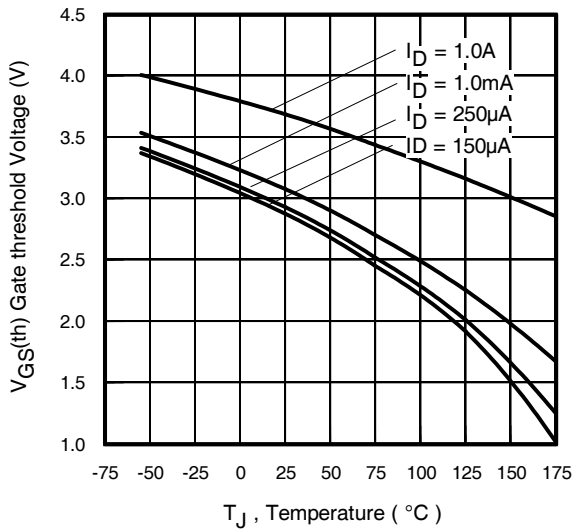
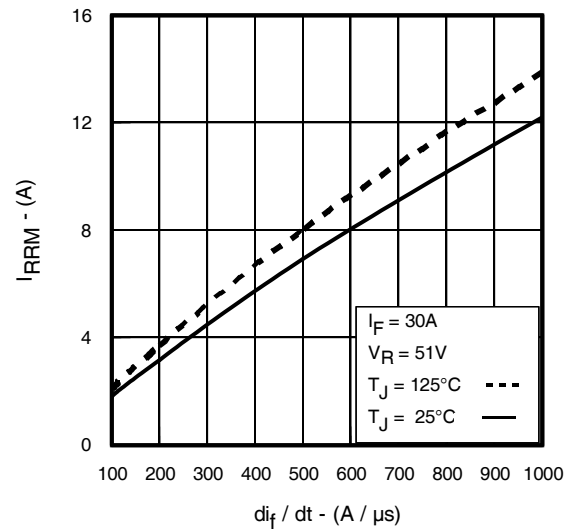
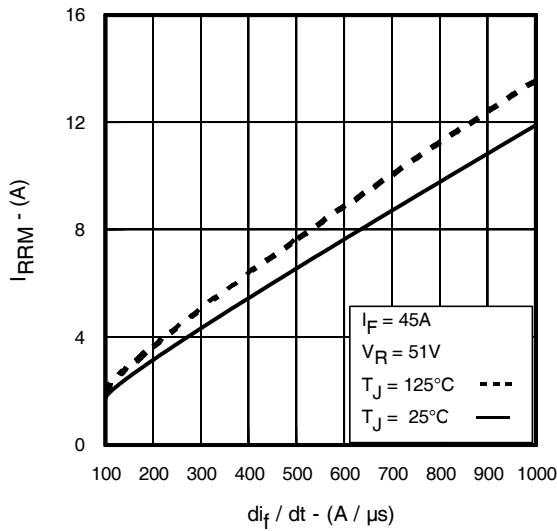
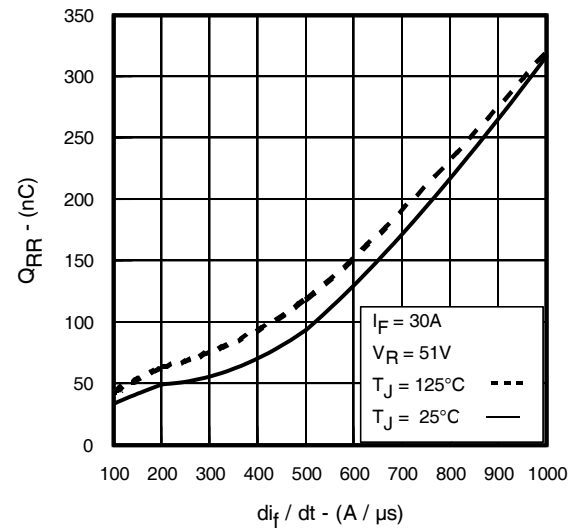
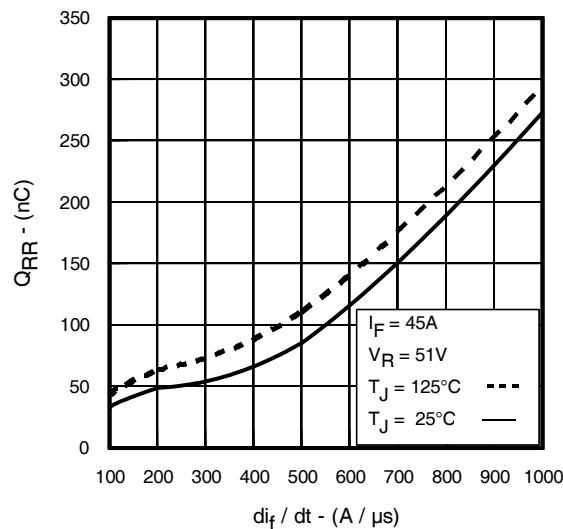
1. Avalanche failures assumption:  
Purely a thermal phenomenon and failure occurs at a temperature far in excess of  $T_{jmax}$ . This is validated for every part type.
2. Safe operation in Avalanche is allowed as long as  $T_{jmax}$  is not exceeded.
3. Equation below based on circuit and waveforms shown in Figures 22a, 22b.
4.  $P_{D(ave)}$  = Average power dissipation per single avalanche pulse.
5.  $BV$  = Rated breakdown voltage (1.3 factor accounts for voltage increase during avalanche).
6.  $I_{av}$  = Allowable avalanche current.
7.  $\Delta T$  = Allowable rise in junction temperature, not to exceed  $T_{jmax}$  (assumed as 25°C in Figure 13, 14).  
 $t_{av}$  = Average time in avalanche.  
 $D$  = Duty cycle in avalanche =  $t_{av} \cdot f$   
 $Z_{thJC}(D, t_{av})$  = Transient thermal resistance, see Figures 13)

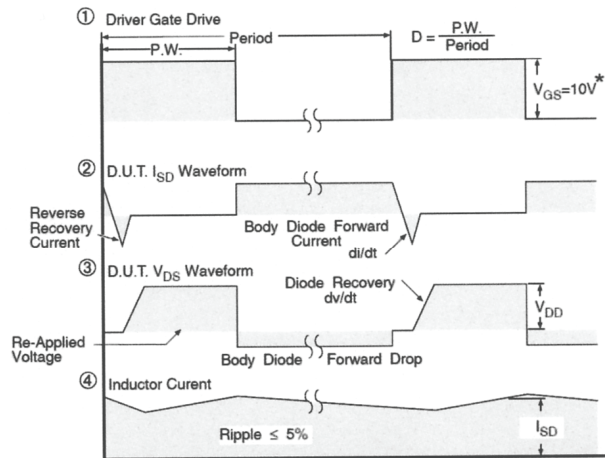
$$P_{D(ave)} = 1/2 ( 1.3 \cdot BV \cdot I_{av} ) = \Delta T / Z_{thJC}$$

$$I_{av} = 2\Delta T / [ 1.3 \cdot BV \cdot Z_{th} ]$$

$$E_{AS(AR)} = P_{D(ave)} \cdot t_{av}$$

**Fig 15. Maximum Avalanche Energy vs. Temperature**


**Fig 16.** Threshold Voltage vs. Temperature

**Fig. 17 -** Typical Recovery Current vs.  $di/dt$ 

**Fig. 18 -** Typical Recovery Current vs.  $di/dt$ 

**Fig. 19 -** Typical Stored Charge vs.  $di/dt$ 

**Fig. 20 -** Typical Stored Charge vs.  $di/dt$

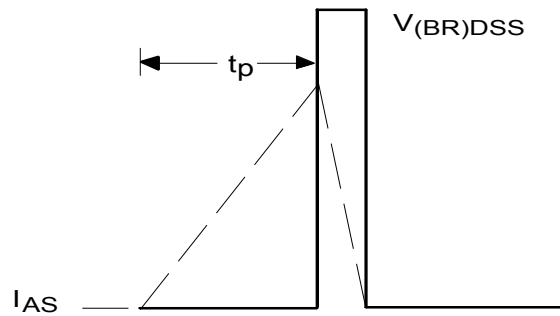


\*  $V_{GS} = 5V$  for Logic Level Devices

**Fig 21.** Peak Diode Recovery  $dv/dt$  Test Circuit for N-Channel HEXFET® Power MOSFETs



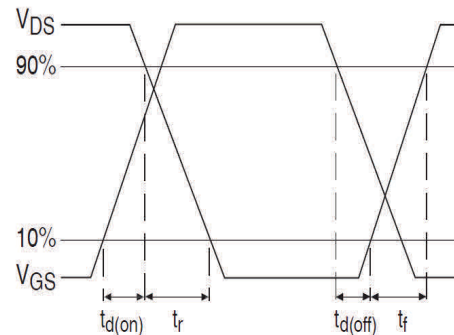
**Fig 22a.** Unclamped Inductive Test Circuit



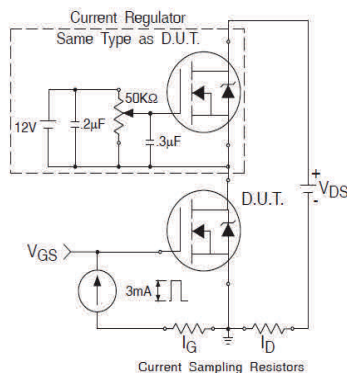
**Fig 22b.** Unclamped Inductive Waveforms



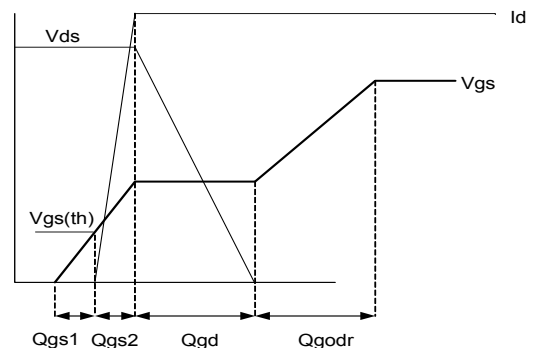
**Fig 23a.** Switching Time Test Circuit



**Fig 23b.** Switching Time Waveforms

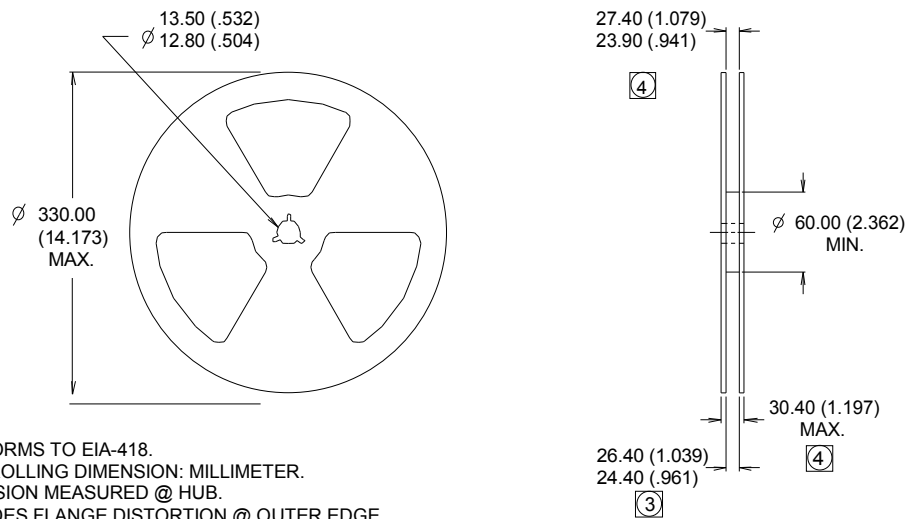
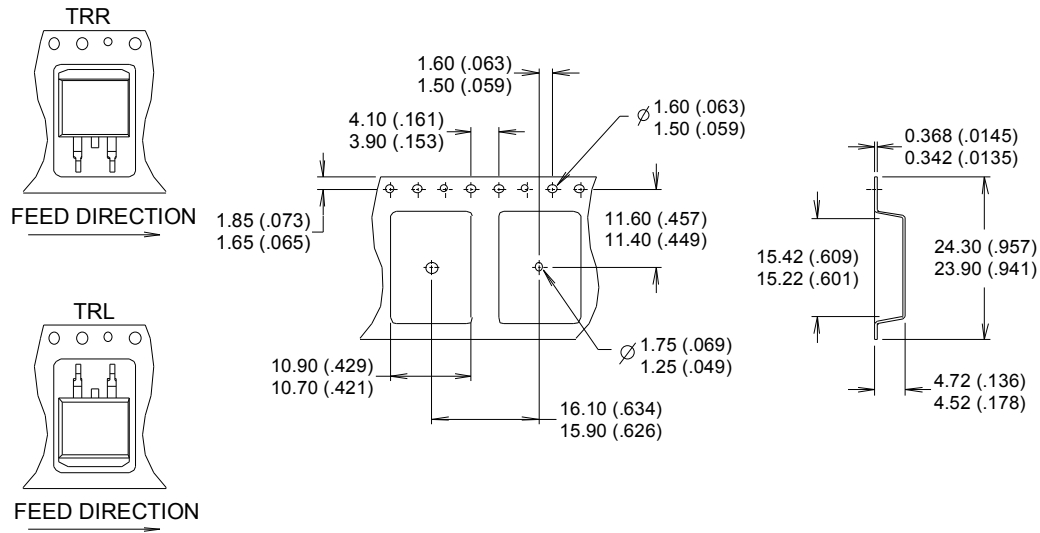


**Fig 24a.** Gate Charge Test Circuit



**Fig 24b.** Gate Charge Waveform



**D<sup>2</sup>- Pak (TO-263AB) Tape & Reel Information** (Dimensions are shown in millimeters (inches))


- NOTES :
1. COMFORMS TO EIA-418.
  2. CONTROLLING DIMENSION: MILLIMETER.
  3. DIMENSION MEASURED @ HUB.
  4. INCLUDES FLANGE DISTORTION @ OUTER EDGE.

**Qualification Information**

<b>Qualification Level</b>		Automotive (per AEC-Q101)	
		Comments: This part number(s) passed Automotive qualification. Infineon's Industrial and Consumer qualification level is granted by extension of the higher Automotive level.	
<b>Moisture Sensitivity Level</b>		D <sup>2</sup> -Pak	MSL1
<b>ESD</b>	Machine Model	Class M4 (+/- 800V) <sup>†</sup> AEC-Q101-002	
	Human Body Model	Class H2 (+/- 3000V) <sup>†</sup> AEC-Q101-001	
	Charged Device Model	Class C5 (+/- 2000V) <sup>†</sup> AEC-Q101-005	
<b>RoHS Compliant</b>		Yes	

† Highest passing voltage.

**Revision History**

Date	Comments
10/11/2017	<ul style="list-style-type: none"> <li>Updated datasheet with corporate template</li> <li>Corrected typo error on part marking on page 8.</li> </ul>

**Published by**

**Infineon Technologies AG**  
81726 München, Germany

© Infineon Technologies AG 2015

All Rights Reserved.

**IMPORTANT NOTICE**

The information given in this document shall in no event be regarded as a guarantee of conditions or characteristics ("Beschaffenhheitsgarantie"). With respect to any examples, hints or any typical values stated herein and/or any information regarding the application of the product, Infineon Technologies hereby disclaims any and all warranties and liabilities of any kind, including without limitation warranties of non-infringement of intellectual property rights of any third party.

In addition, any information given in this document is subject to customer's compliance with its obligations stated in this document and any applicable legal requirements, norms and standards concerning customer's products and any use of the product of Infineon Technologies in customer's applications.

The data contained in this document is exclusively intended for technically trained staff. It is the responsibility of customer's technical departments to evaluate the suitability of the product for the intended application and the completeness of the product information given in this document with respect to such application.

For further information on the product, technology, delivery terms and conditions and prices please contact your nearest Infineon Technologies office ([www.infineon.com](http://www.infineon.com)).

**WARNINGS**

Due to technical requirements products may contain dangerous substances. For information on the types in question please contact your nearest Infineon Technologies office.

Except as otherwise explicitly approved by Infineon Technologies in a written document signed by authorized representatives of Infineon Technologies, Infineon Technologies' products may not be used in any applications where a failure of the product or any consequences of the use thereof can reasonably be expected to result in personal injury.

## Looking for pricing, stock, or lifecycle information?

Click below to explore more details on WIN SOURCE:

 [View AUIRFS3306TRL on WIN SOURCE](#)

 [Infineon Technologies](#) Information

## Optimize Your Supply Chain with WIN SOURCE Solutions

-  Global Sourcing Solution
-  Obsolete Management
-  Cost Control Management
-  Shortage Management
-  Alternative Solution
-  Excess Inventory Management