



**THE DATASHEET OF  
AZ1084D-1.5TRG1**



**5A LOW DROPOUT LINEAR REGULATOR**

**Description**

The AZ1084 is a series of low dropout positive voltage regulators with a maximum dropout of 1.5V at 5A of load current.

The series features on-chip thermal limiting which provides protection against any combination of overload and ambient temperatures that would create excessive junction temperatures. It also includes a trimmed band-gap reference and a current limiting circuit.

The AZ1084 is available in 1.5V, 1.8V, 2.5V, 3.3V and 5.0V versions. The fixed versions integrate the adjust resistors. It is also available in an adjustable version which can set the output voltage with two external resistors.

The AZ1084 series is available in standard packages of TO263, TO-263-2, TO-220-3, TO-252-2 (3), TO-252-2 (4) and TO-252-2 (5).

**Features**

- Low Dropout Voltage: 1.3V Typical at 5A
- Current Limiting and Thermal Protection
- Output Current: 5A
- Current Limit: 6.5A
- Operating Junction Temperature Range: 0 to +125°C
- Line Regulation (Adj Version): 0.015% (Typical)
- Load Regulation (Adj Version): 0.1% (Typical)
- Lead-Free Packages: TO263, TO-263-2, TO-220-3, TO-252-2 (3), TO-252-2 (4), TO-252-2 (5)
  - **Totally Lead-Free; RoHS Compliant (Notes 1 & 2)**
- Lead-Free Packages, Available in "Green" Molding Compound: TO263, TO-263-2, TO-220-3, TO-252-2 (3), TO-252-2 (4), TO-252-2 (5)
  - **Totally Lead-Free & Fully RoHS Compliant (Notes 1 & 2)**
  - **Halogen and Antimony Free. "Green" Device (Note 3)**

**Applications**

- High Efficiency Linear Regulators
- Battery Chargers
- Post Regulation for Switching Supply
- Microprocessor Supply
- Desktop PCs, RISC and Embedded Processors' Supply

Notes: 1. No purposely added lead. Fully EU Directive 2002/95/EC (RoHS) & 2011/65/EU (RoHS 2) compliant.  
 2. See [http://www.diodes.com/quality/lead\\_free.html](http://www.diodes.com/quality/lead_free.html) for more information about Diodes Incorporated's definitions of Halogen- and Antimony-free, "Green" and Lead-free.  
 3. Halogen- and Antimony-free "Green" products are defined as those which contain <900ppm bromine, <900ppm chlorine (<1500ppm total Br + Cl) and <1000ppm antimony compounds.

**Pin Assignments**

S Package  
(TO263)



S2 Package  
(TO-263-2)



D Package  
(TO-252-2 (3) (Option 1))

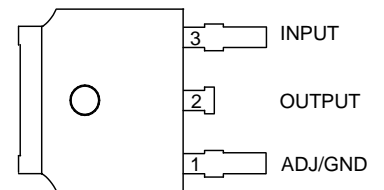

(TO-252-2 (3) (Option 2))

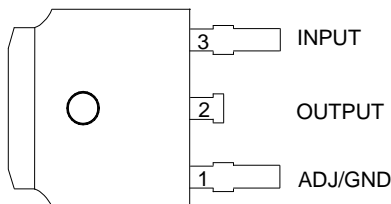

D Packages  
(TO-252-2 (4))

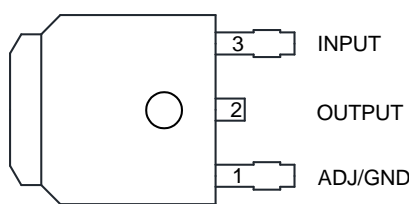

(TO-252-2 (5))

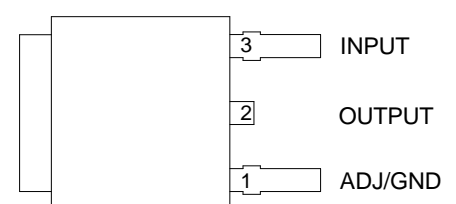

**Pin Assignments (Cont.)**



**Typical Applications Circuit**

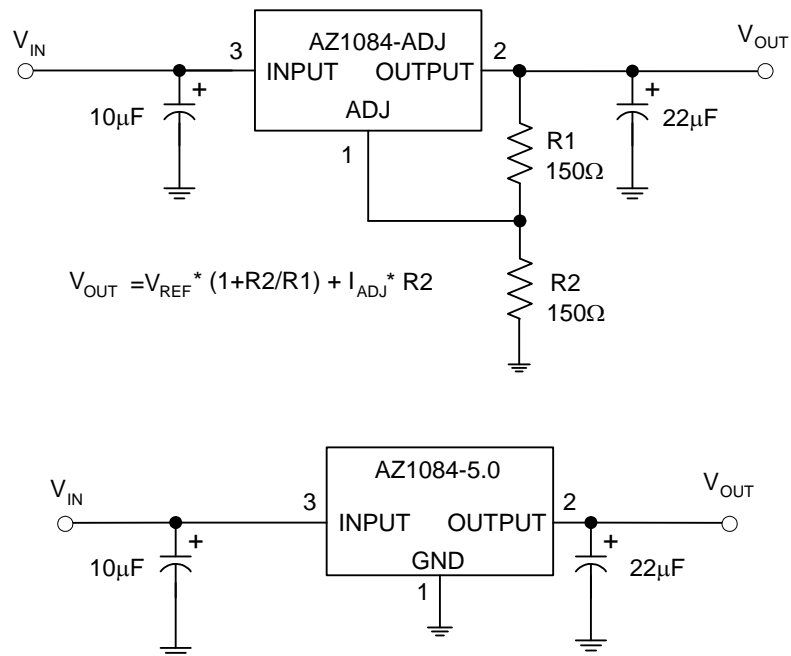

**Functional Block Diagram**

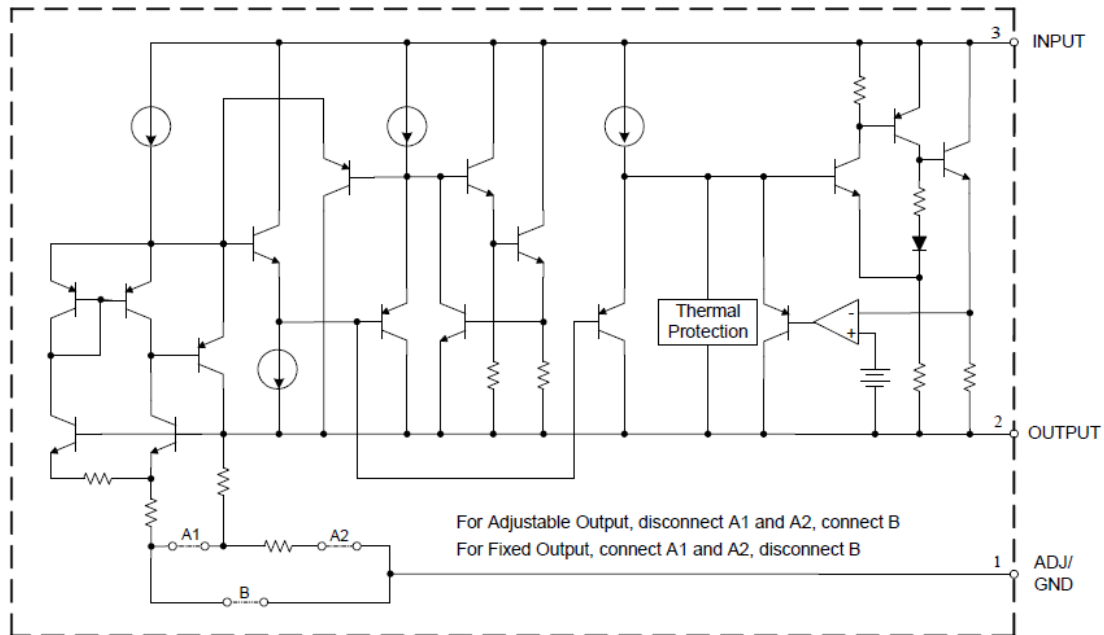

**Absolute Maximum Ratings** (Note 4)

Symbol	Parameter	Rating		Unit
T <sub>J</sub>	Operating Junction Temperature	+150		°C
T <sub>STG</sub>	Storage Temperature Range	-65 to +150		°C
T <sub>LEAD</sub>	Lead Temperature (Soldering, 10 sec.)	+260		°C
θ <sub>JA</sub>	Thermal Resistance (Note 5)	TO-263-2	60	°C/W
		TO263	60	
		TO-220-3	60	
		TO-252-2 (3)/TO-252-2 (4)/TO-252-2 (5)	100	
ESD	ESD (Human Body Model)	2000		V
ESD	ESD (Machine Model)	400		V

- Notes
- Stresses greater than those listed under "Absolute Maximum Ratings" may cause permanent damage to the device. These are stress ratings only, and functional operation of the device at these or any other conditions beyond those indicated under "Recommended Operating Conditions" is not implied. Exposure to "Absolute Maximum Ratings" for extended periods may affect device reliability.
  - Absolute maximum ratings indicate limits beyond which damage to the component may occur. Electrical specifications do not apply when operating the device outside of its operating ratings. The maximum allowable power dissipation is a function of the maximum junction temperature, T<sub>J(max)</sub>, the junction-to-ambient thermal resistance, θ<sub>JA</sub>, and the ambient temperature, T<sub>A</sub>. The maximum allowable power dissipation at any ambient temperature is calculated using: P<sub>D(max)</sub>=(T<sub>J(max)</sub>-T<sub>A</sub>)/θ<sub>JA</sub>. Exceeding the maximum allowable power dissipation will result in excessive die temperature, and the regulator will go into thermal shutdown.

## Recommended Operating Conditions

Symbol	Parameter	Min	Max	Unit
$V_{IN}$	Input Voltage	–	12	V
$T_J$	Operating Junction Temperature Range	0	+125	°C

**Electrical Characteristics** (Typicals and limits appearing in normal type apply for  $T_J = +25^\circ\text{C}$ . Limits appearing in **Boldface** type apply over the entire operating junction temperature range.)

Symbol	Parameter	Conditions	Min	Typ	Max	Unit
$V_{REF}$	Reference Voltage	AZ1084-ADJ, $I_{OUT} = 10\text{mA}$ , $V_{IN}-V_{OUT} = 3\text{V}$ , $10\text{mA} \leq I_{OUT} \leq 5\text{A}$ , $1.5\text{V} \leq V_{IN}-V_{OUT} \leq 5\text{V}$	1.238 <b>1.225</b>	1.250 <b>1.250</b>	1.262 <b>1.270</b>	V
$V_{OUT}$	Output Voltage	AZ1084-1.5, $I_{OUT} = 0\text{mA}$ , $V_{IN} = 4.5\text{V}$ , $10\text{mA} \leq I_{OUT} \leq 5\text{A}$ , $3.0\text{V} \leq V_{IN} \leq 6\text{V}$	1.485 <b>1.47</b>	1.5 <b>1.5</b>	1.515 <b>1.53</b>	V
		AZ1084-1.8, $I_{OUT} = 0\text{mA}$ , $V_{IN} = 4.8\text{V}$ , $10\text{mA} \leq I_{OUT} \leq 5\text{A}$ , $3.3\text{V} \leq V_{IN} \leq 6\text{V}$	1.782 <b>1.764</b>	1.8 <b>1.8</b>	1.818 <b>1.836</b>	V
		AZ1084-2.5, $I_{OUT} = 0\text{mA}$ , $V_{IN} = 5.5\text{V}$ , $10\text{mA} \leq I_{OUT} \leq 5\text{A}$ , $4.0\text{V} \leq V_{IN} \leq 7\text{V}$	2.475 <b>2.45</b>	2.5 <b>2.5</b>	2.525 <b>2.55</b>	V
		AZ1084-3.3, $I_{OUT} = 0\text{mA}$ , $V_{IN} = 6.3\text{V}$ , $10\text{mA} \leq I_{OUT} \leq 5\text{A}$ , $4.8\text{V} \leq V_{IN} \leq 8\text{V}$	3.267 <b>3.234</b>	3.3 <b>3.3</b>	3.333 <b>3.366</b>	V
		AZ1084-5.0, $I_{OUT} = 0\text{mA}$ , $V_{IN} = 8\text{V}$ , $10\text{mA} \leq I_{OUT} \leq 5\text{A}$ , $6.5\text{V} \leq V_{IN} \leq 10\text{V}$	4.95 <b>4.9</b>	5 <b>5</b>	5.05 <b>5.1</b>	V
$\Delta V_{OUT}$	Line Regulation	AZ1084-ADJ, $I_{OUT} = 10\text{mA}$ , $2.85\text{V} \leq V_{IN} \leq 10\text{V}$	–	0.015 <b>0.035</b>	0.2 <b>0.2</b>	%
		AZ1084-1.5, $I_{OUT} = 10\text{mA}$ , $3.0\text{V} \leq V_{IN} \leq 10\text{V}$	–	0.5 <b>1</b>	6 <b>6</b>	mV
		AZ1084-1.8, $I_{OUT} = 10\text{mA}$ , $3.3\text{V} \leq V_{IN} \leq 10\text{V}$	–	0.5 <b>1</b>	6 <b>6</b>	mV
		AZ1084-2.5, $I_{OUT} = 10\text{mA}$ , $4.0\text{V} \leq V_{IN} \leq 10\text{V}$	–	0.5 <b>1</b>	6 <b>6</b>	mV
		AZ1084-3.3, $I_{OUT} = 10\text{mA}$ , $4.8\text{V} \leq V_{IN} \leq 10\text{V}$	–	0.5 <b>1</b>	6 <b>6</b>	mV
		AZ1084-5.0, $I_{OUT} = 10\text{mA}$ , $6.5\text{V} \leq V_{IN} \leq 10\text{V}$	–	0.5 <b>1</b>	10 <b>10</b>	mV
$\Delta V_{OUT}$	Load Regulation	AZ1084-ADJ, $0\text{mA} \leq I_{OUT} \leq 5\text{A}$ , $V_{IN}-V_{OUT} = 3\text{V}$	–	0.1 <b>0.2</b>	0.3 <b>0.4</b>	%
		AZ1084-1.5, $0\text{mA} \leq I_{OUT} \leq 5\text{A}$ , $V_{IN}-V_{OUT} = 3\text{V}$	–	3 <b>7</b>	15 <b>20</b>	mV
		AZ1084-1.8, $0\text{mA} \leq I_{OUT} \leq 5\text{A}$ , $V_{IN}-V_{OUT} = 3\text{V}$	–	3 <b>7</b>	15 <b>20</b>	mV
		AZ1084-2.5, $0\text{mA} \leq I_{OUT} \leq 5\text{A}$ , $V_{IN}-V_{OUT} = 3\text{V}$	–	3 <b>7</b>	15 <b>20</b>	mV
		AZ1084-3.3, $0\text{mA} \leq I_{OUT} \leq 5\text{A}$ , $V_{IN}-V_{OUT} = 3\text{V}$	–	3 <b>7</b>	15 <b>20</b>	mV
		AZ1084-5.0, $0\text{mA} \leq I_{OUT} \leq 5\text{A}$ , $V_{IN}-V_{OUT} = 3\text{V}$	–	5 <b>10</b>	20 <b>35</b>	mV

**Electrical Characteristics** (Cont. Typical and limits appearing in normal type apply for  $T_J = +25^\circ\text{C}$ . Limits appearing in **Boldface** type apply over the entire operating junction temperature range.)

Symbol	Parameter	Conditions	Min	Typ	Max	Unit
$V_{\text{DROP}}$	Dropout Voltage	$I_{\text{OUT}} = 5\text{A}$ , $\Delta V_{\text{REF}}$ , $\Delta V_{\text{OUT}} = 1\%$	–	<b>1.3</b>	<b>1.5</b>	V
$\theta_{\text{JC}}$	Thermal Resistance	TO-220-3	–	4.15	–	$^\circ\text{C/W}$
		TO-252-2 (3)/TO-252-2 (4)/TO-252-2 (5)	–	7.36	–	
		TO263	–	4.15	–	
		TO-263-2	–	4.15	–	
$I_{\text{LIMIT}}$	Current Limit	$V_{\text{IN}} - V_{\text{OUT}} = 3\text{V}$	5.5	6.5	–	A
$I_{\text{LOAD (MIN)}}$	Minimum Load Current	$V_{\text{IN}} = 10\text{V}$ (AZ1084-ADJ)	–	<b>3</b>	<b>10</b>	mA
$I_{\text{Q}}$	Quiescent Current	$V_{\text{IN}} = 10\text{V}$ (AZ1084)	–	<b>5</b>	<b>10</b>	mA
PSRR	Ripple Rejection	$f_{\text{RIPPLE}} = 120\text{Hz}$ , $C_{\text{OUT}} = 25\mu\text{F}$ Tantalum, $I_{\text{OUT}} = 5\text{A}$ , $V_{\text{IN}} - V_{\text{OUT}} = 3\text{V}$	<b>60</b>	<b>72</b>	–	dB
$I_{\text{ADJ}}$	Adjust Pin Current	$V_{\text{IN}} = 4.25\text{V}$ , $I_{\text{OUT}} = 10\text{mA}$	–	55	<b>120</b>	$\mu\text{A}$
$\Delta I_{\text{ADJ}}$	Adjust Pin Current Change	$10\text{mA} \leq I_{\text{OUT}} \leq 5\text{A}$ , $1.5\text{V} \leq (V_{\text{IN}} - V_{\text{OUT}}) \leq 4.5\text{V}$	–	<b>0.2</b>	<b>5</b>	$\mu\text{A}$
–	Temperature Stability	$I_{\text{OUT}} = 10\text{mA}$ , $V_{\text{IN}} - V_{\text{OUT}} = 1.5$	–	<b>0.5</b>	–	%
–	Long Term Stability	$T_A = 125^\circ\text{C}$ , 1000Hrs	–	0.5	–	%
–	RMS Noise (% of $V_{\text{OUT}}$ )	$10\text{Hz} \leq f \leq 10\text{kHz}$	–	0.003	–	%

**Typical Performance Characteristics**

**Dropout Voltage vs. Output Current**

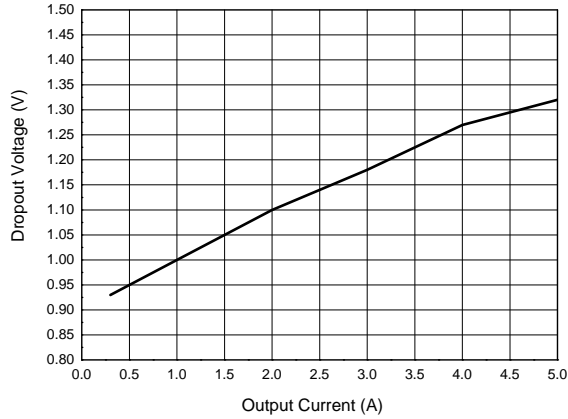

**Output Voltage vs. Junction Temperature**



**Reference Voltage vs. Junction Temperature**



**Minimum Load Current vs. Junction Temperature**



**Adjust Pin Current vs. Junction Temperature**



**Power Dissipation vs. Case Temperature**

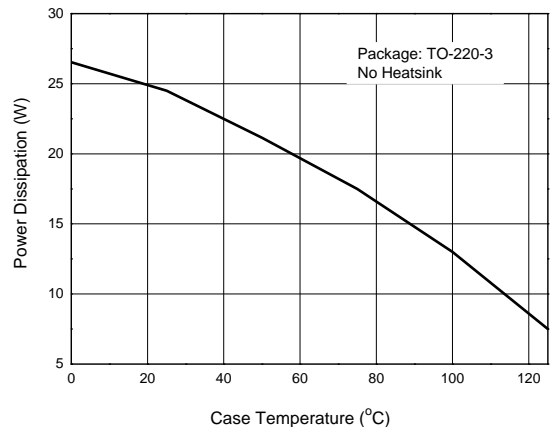

**Performance Characteristics (Cont.)**

**Line Regulation vs. Junction Temperature**

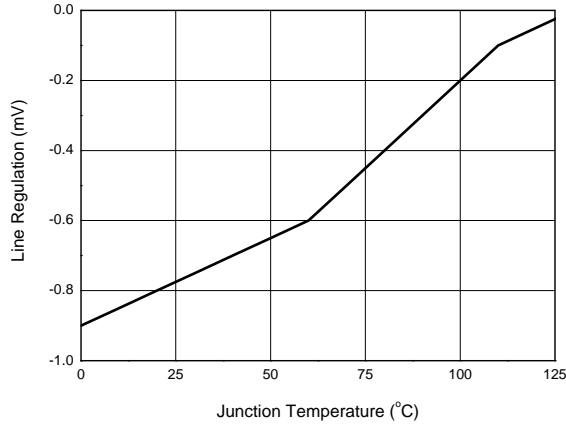

**Adjust Pin Current vs. Output Current**

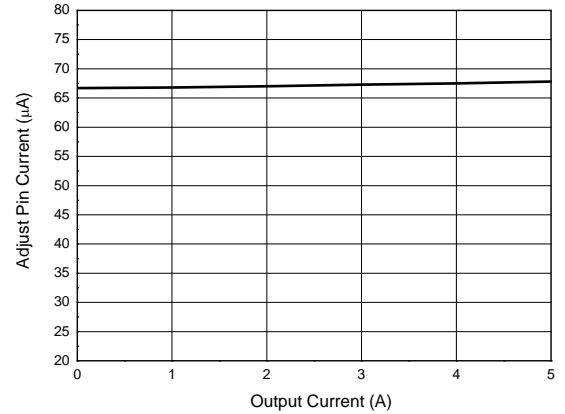

**Dropout Voltage vs. Junction Temperature**

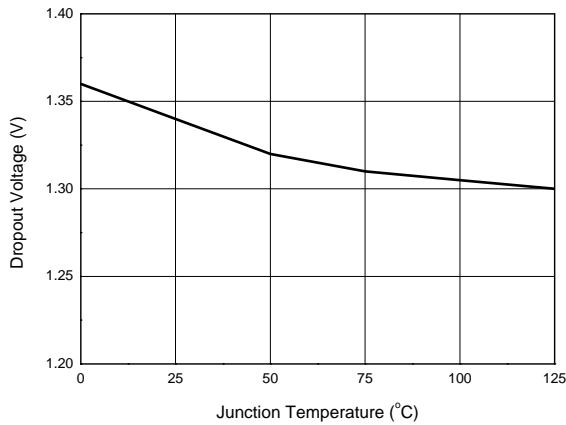

**Short Circuit Current vs. Dropout Voltage**

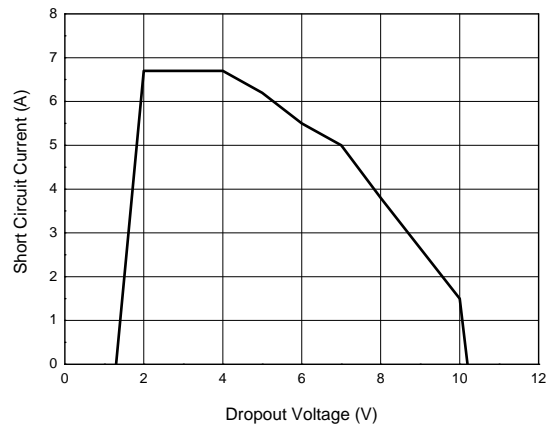

**Load Transient Response**

(Conditions:  $V_{IN} = 5.5V$ ,  $V_{OUT} = 2.5V$ ,  $I_{OUT} = 10mA$  to  $5A$   
 $C_{IN} = 10\mu F$ ,  $C_{OUT} = 10\mu F$ )



**Line Transient Response**

(Conditions:  $V_{IN} = 4.5V$  to  $6.5V$ ,  $V_{OUT} = 2.5V$ ,  
 $I_{OUT} = 200mA$ ,  $C_{OUT} = 10\mu F$ )

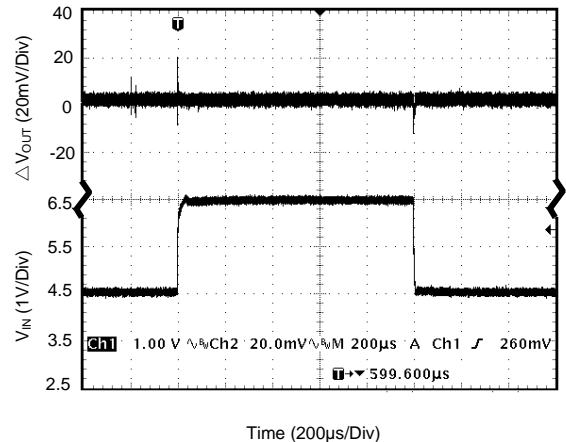

---

**Performance Characteristics** (Cont.)

---

**PSRR vs. Frequency**



## Ordering Information

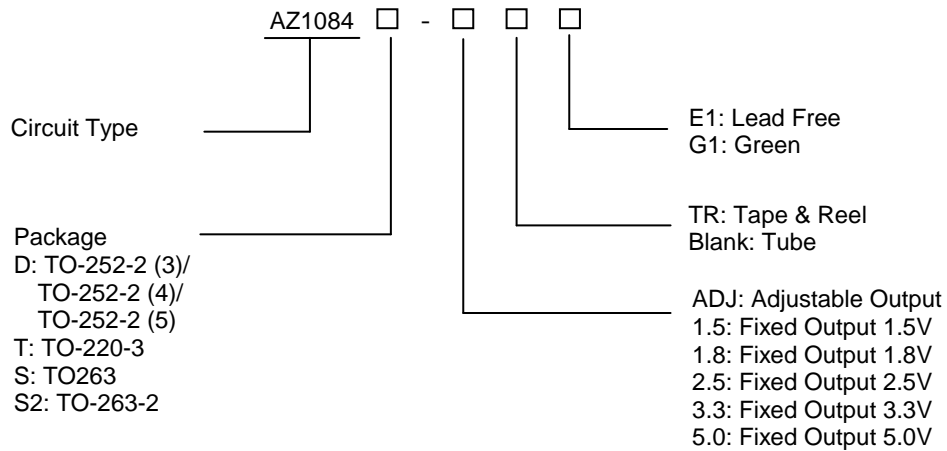

Package	Temperature Range	Part Number		Marking ID		Packing Type
		Lead Free	Green	Lead Free	Green	
 TO-252-2 (3) /TO-252-2 (4) /TO-252-2 (5) 	0 to +125°C	AZ1084D-ADJTRE1	AZ1084D-ADJTRG1	AZ1084D-ADJE1	AZ1084D-ADJG1	Tape & Reel
		AZ1084D-1.5TRE1	AZ1084D-1.5TRG1	AZ1084D-1.5E1	AZ1084D-1.5G1	Tape & Reel
		AZ1084D-1.8TRE1	AZ1084D-1.8TRG1	AZ1084D-1.8E1	AZ1084D-1.8G1	Tape & Reel
		AZ1084D-2.5TRE1	AZ1084D-2.5TRG1	AZ1084D-2.5E1	AZ1084D-2.5G1	Tape & Reel
		AZ1084D-3.3TRE1	AZ1084D-3.3TRG1	AZ1084D-3.3E1	AZ1084D-3.3G1	Tape & Reel
		AZ1084D-5.0TRE1	AZ1084D-5.0TRG1	AZ1084D-5.0E1	AZ1084D-5.0G1	Tape & Reel
 TO-220-3 	0 to +125°C	AZ1084T-ADJE1	AZ1084T-ADJG1	AZ1084T-ADJE1	AZ1084T-ADJG1	Tube
		AZ1084T-1.5E1	AZ1084T-1.5G1	AZ1084T-1.5E1	AZ1084T-1.5G1	Tube
		AZ1084T-1.8E1	AZ1084T-1.8G1	AZ1084T-1.8E1	AZ1084T-1.8G1	Tube
		AZ1084T-2.5E1	AZ1084T-2.5G1	AZ1084T-2.5E1	AZ1084T-2.5G1	Tube
		AZ1084T-3.3E1	AZ1084T-3.3G1	AZ1084T-3.3E1	AZ1084T-3.3G1	Tube
		AZ1084T-5.0E1	AZ1084T-5.0G1	AZ1084T-5.0E1	AZ1084T-5.0G1	Tube

**Ordering Information** (Cont.)



Package	Temperature Range	Part Number		Marking ID		Packing Type
		Lead Free	Green	Lead Free	Green	
TO263	0 to +125°C	AZ1084S-ADJTRE1	AZ1084S-ADJTRG1	AZ1084S-ADJE1	AZ1084S-ADJG1	Tape & Reel
		AZ1084S-1.5TRE1	AZ1084S-1.5TRG1	AZ1084S-1.5E1	AZ1084S-1.5G1	Tape & Reel
		AZ1084S-1.8TRE1	AZ1084S-1.8TRG1	AZ1084S-1.8E1	AZ1084S-1.8G1	Tape & Reel
		AZ1084S-2.5TRE1	AZ1084S-2.5TRG1	AZ1084S-2.5E1	AZ1084S-2.5G1	Tape & Reel
		AZ1084S-3.3TRE1	AZ1084S-3.3TRG1	AZ1084S-3.3E1	AZ1084S-3.3G1	Tape & Reel
		AZ1084S-5.0TRE1	AZ1084S-5.0TRG1	AZ1084S-5.0E1	AZ1084S-5.0G1	Tape & Reel
TO-263-2	0 to +125°C	AZ1084S2-ADJTRE1	AZ1084S2-ADJTRG1	AZ1084S2-ADJE1	AZ1084S2-ADJG1	Tape & Reel
		AZ1084S2-1.5TRE1	AZ1084S2-1.5TRG1	AZ1084S2-1.5E1	AZ1084S2-1.5G1	Tape & Reel
		AZ1084S2-1.8TRE1	AZ1084S2-1.8TRG1	AZ1084S2-1.8E1	AZ1084S2-1.8G1	Tape & Reel
		AZ1084S2-2.5TRE1	AZ1084S2-2.5TRG1	AZ1084S2-2.5E1	AZ1084S2-2.5G1	Tape & Reel
		AZ1084S2-3.3TRE1	AZ1084S2-3.3TRG1	AZ1084S2-3.3E1	AZ1084S2-3.3G1	Tape & Reel
		AZ1084S2-5.0TRE1	AZ1084S2-5.0TRG1	AZ1084S2-5.0E1	AZ1084S2-5.0G1	Tape & Reel

BCD Semiconductor's Pb-free products, as designated with "E1" suffix in the part number, are RoHS compliant. Products with "G1" suffix are available in green packages.

**Package Outline Dimensions** (All dimensions in mm(inch).)

**TO263**

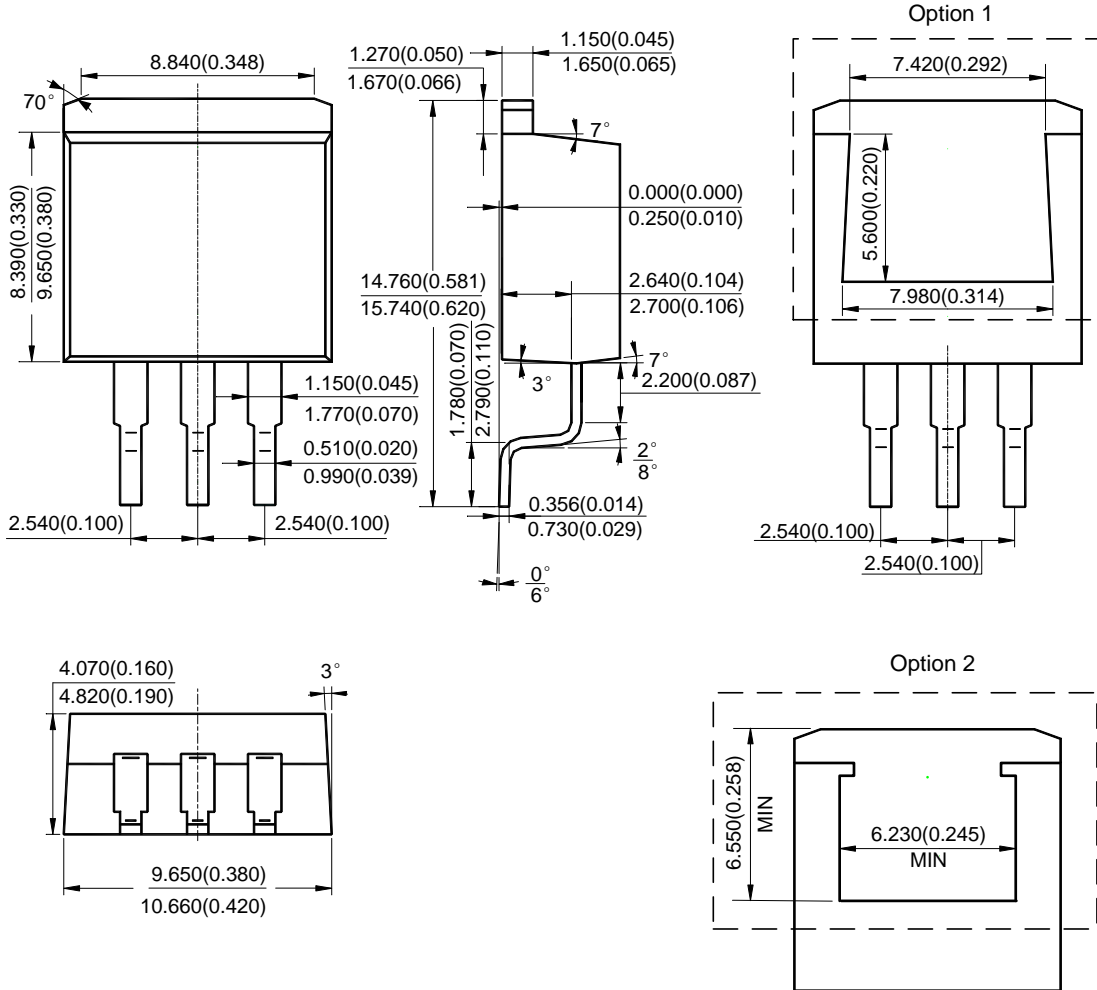

**Package Outline Dimensions** (Cont. All dimensions in mm(inch).)

**TO-263-2**

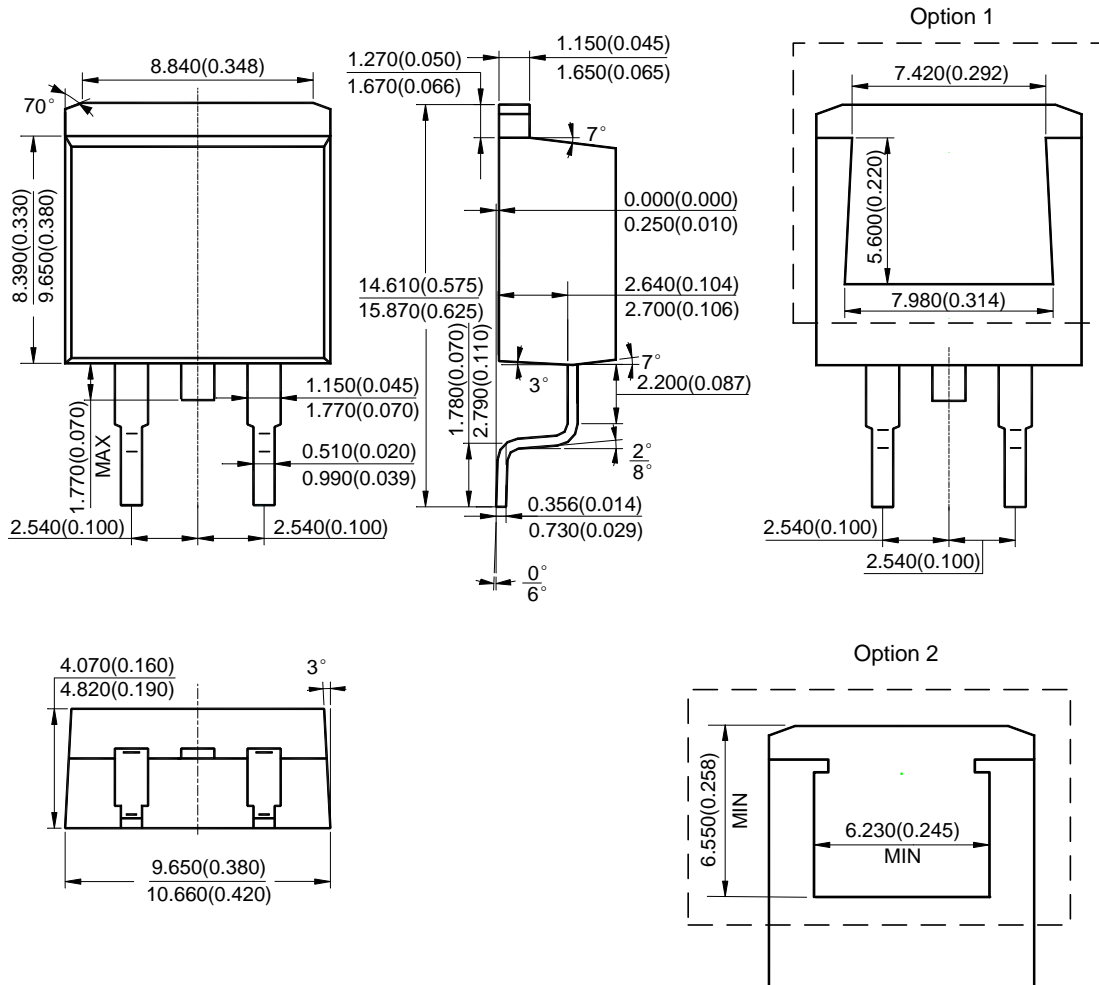

**Package Outline Dimensions** (Cont. All dimensions in mm(inch).)

**TO-220-3**



Option 2



Option 3

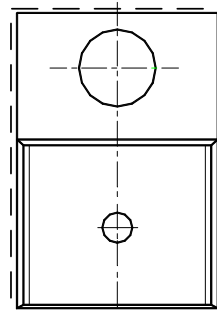



**Package Outline Dimensions** (Cont. All dimensions in mm(inch).)

**TO-252-2 (4)**

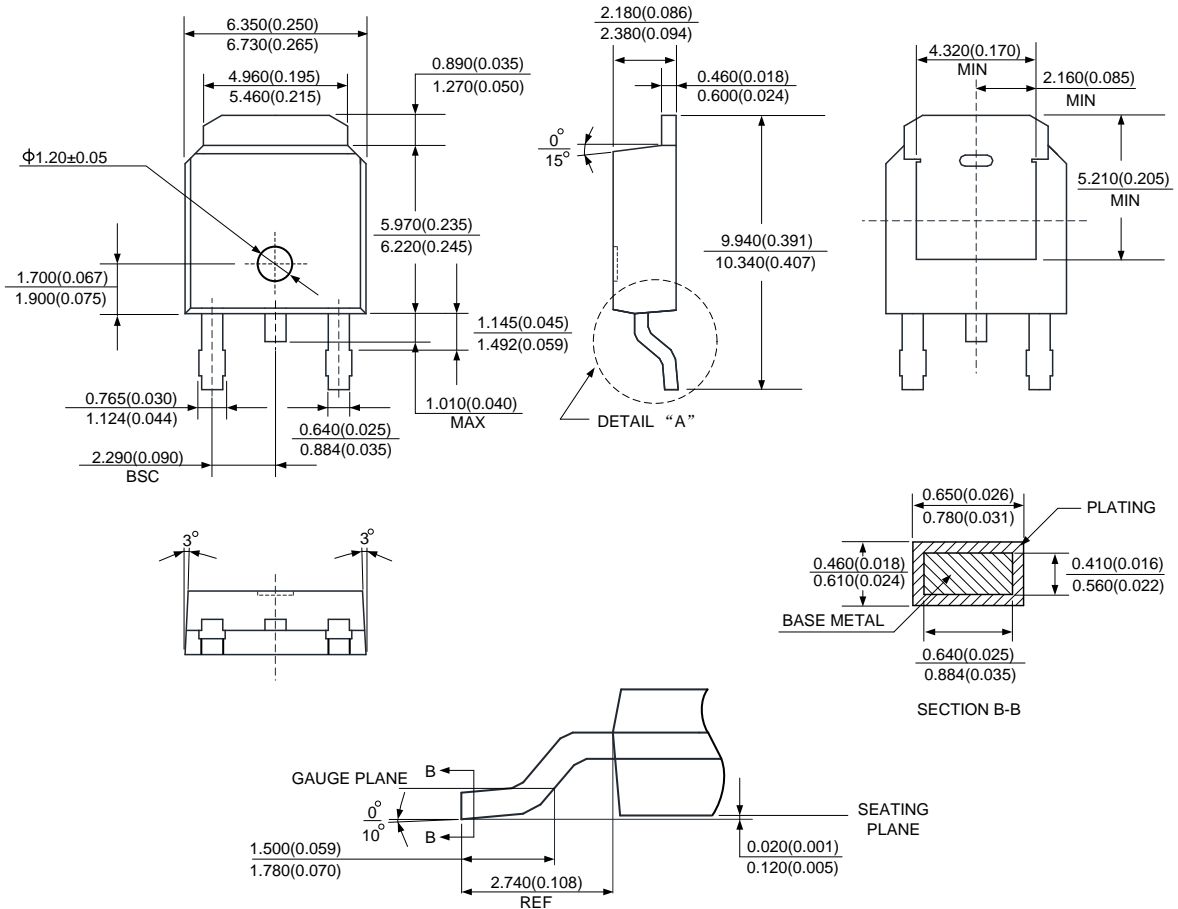

**Package Outline Dimensions** (Cont. All dimensions in mm(inch).)

**TO-252-2 (5)**

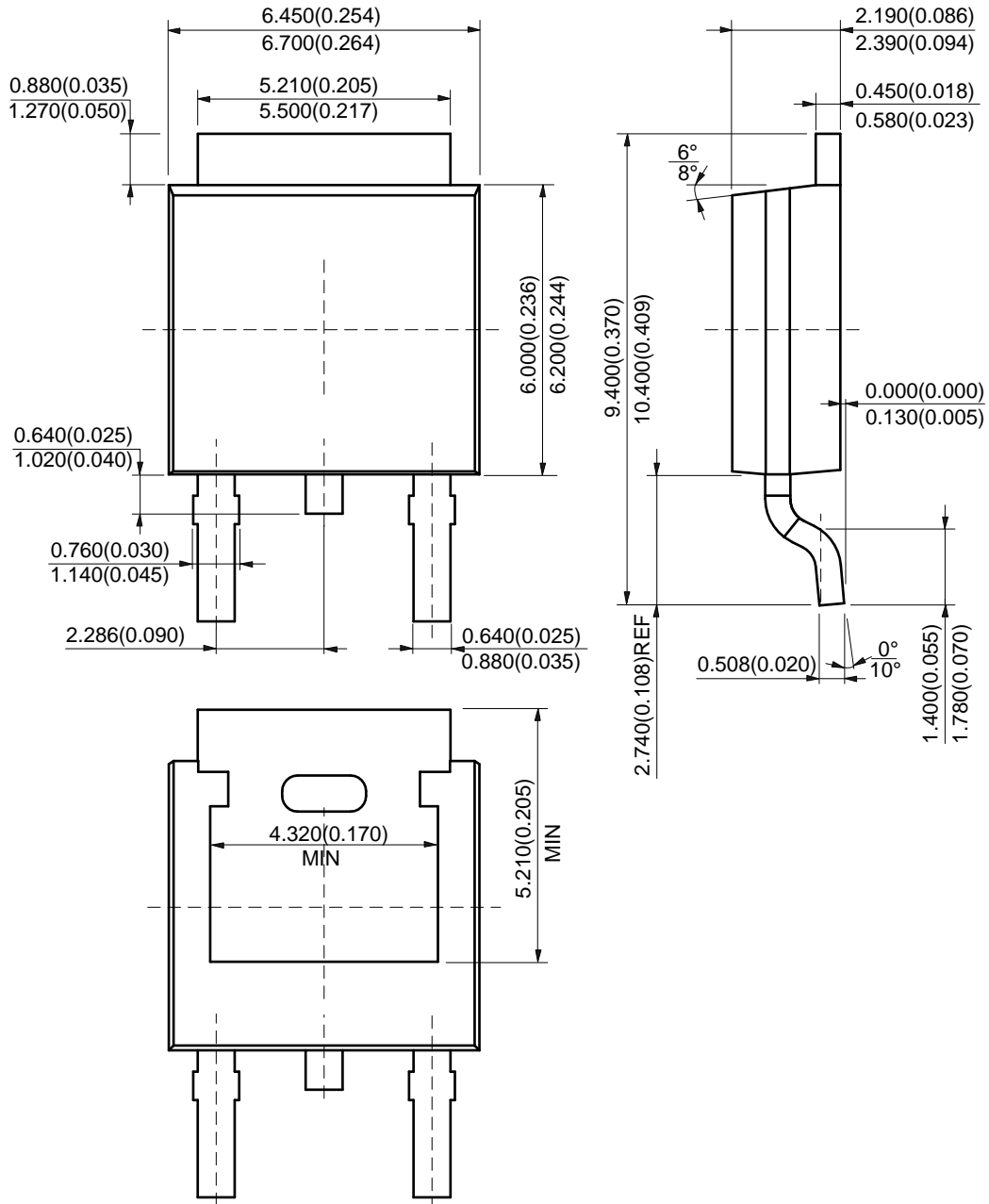

**Suggested Pad Layout**

**T0263**

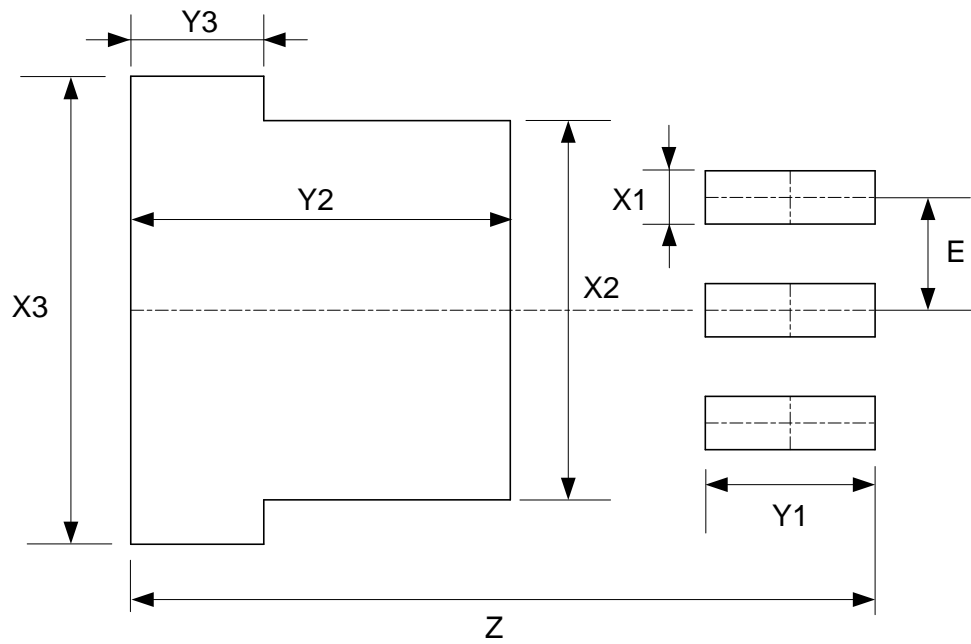

Dimensions	Z (mm)/(inch)	X1 (mm)/(inch)	X2 (mm)/(inch)	X3 (mm)/(inch)
Value	16.760/0.660	1.200/0.047	8.540/0.336	10.540/0.415
Dimensions	Y1 (mm)/(inch)	Y2 (mm)/(inch)	Y3 (mm)/(inch)	E (mm)/(inch)
Value	3.830/0.151	8.560/0.337	3.000/0.118	2.540/0.100

**Suggested Pad Layout (Cont.)**

**TO-263-2**



Dimensions	Z (mm)/(inch)	X1 (mm)/(inch)	X2 (mm)/(inch)	X3 (mm)/(inch)
Value	16.760/0.660	1.200/0.047	8.540/0.336	10.540/0.415
Dimensions	Y1 (mm)/(inch)	Y2 (mm)/(inch)	Y3 (mm)/(inch)	E (mm)/(inch)
Value	3.830/0.151	8.560/0.337	3.000/0.118	5.080/0.200

**Suggested Pad Layout (Cont.)**

**TO-252-2 (3)**

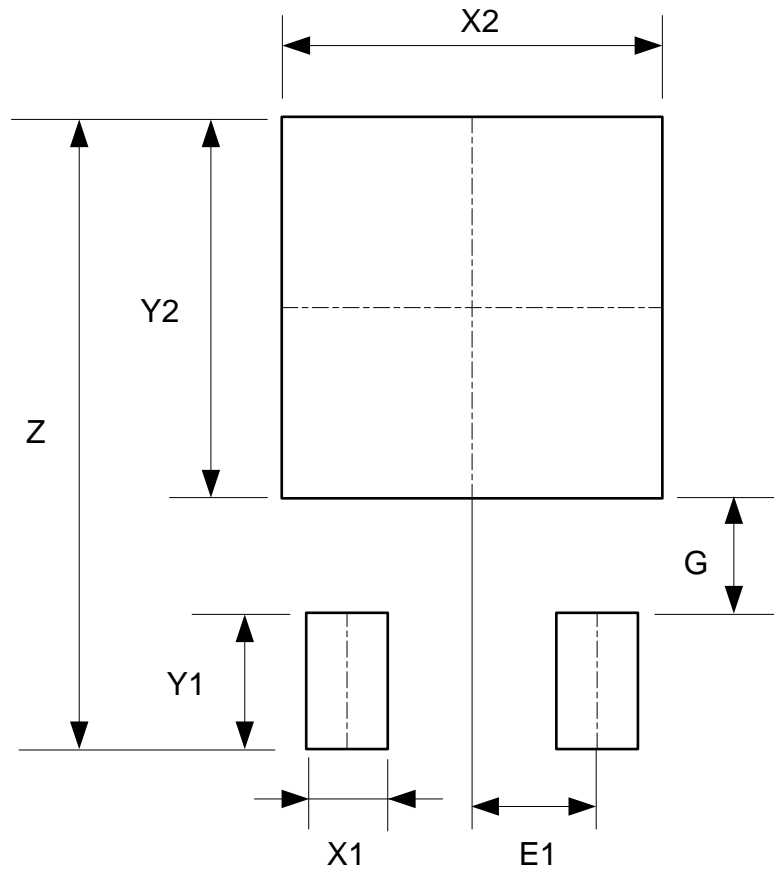

Dimensions	Z (mm)/(inch)	X1 (mm)/(inch)	X2=Y2 (mm)/(inch)	Y1 (mm)/(inch)	G (mm)/(inch)	E1 (mm)/(inch)
Value	11.600/0.457	1.500/0.059	7.000/0.276	2.500/0.098	2.100/0.083	2.300/0.091

**Suggested Pad Layout (Cont.)**

**TO-252-2 (4)**



Dimensions	Z (mm)/(inch)	X1 (mm)/(inch)	X2=Y2 (mm)/(inch)	Y1 (mm)/(inch)	G (mm)/(inch)	E1 (mm)/(inch)
Value	11.600/0.457	1.500/0.059	7.000/0.276	2.500/0.098	2.100/0.083	2.300/0.091

**Suggested Pad Layout (Cont.)**

**TO-252-2 (5)**

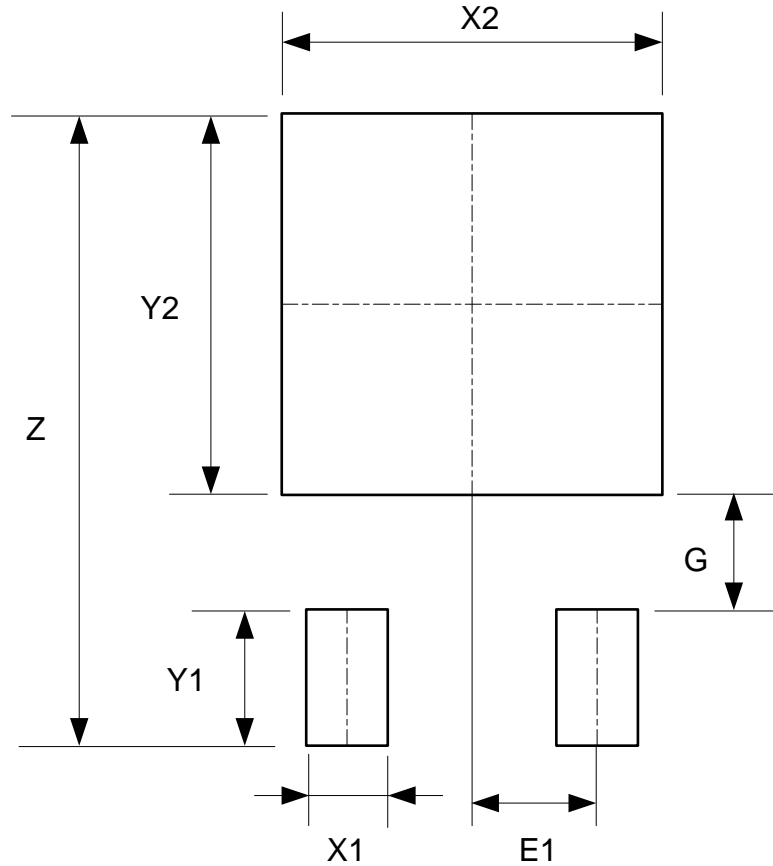

Dimensions	Z (mm)/(inch)	X1 (mm)/(inch)	X2=Y2 (mm)/(inch)	Y1 (mm)/(inch)	G (mm)/(inch)	E1 (mm)/(inch)
Value	11.600/0.457	1.500/0.059	7.000/0.276	2.500/0.098	2.100/0.083	2.300/0.091

**IMPORTANT NOTICE**

DIODES INCORPORATED MAKES NO WARRANTY OF ANY KIND, EXPRESS OR IMPLIED, WITH REGARDS TO THIS DOCUMENT, INCLUDING, BUT NOT LIMITED TO, THE IMPLIED WARRANTIES OF MERCHANTABILITY AND FITNESS FOR A PARTICULAR PURPOSE (AND THEIR EQUIVALENTS UNDER THE LAWS OF ANY JURISDICTION).

Diodes Incorporated and its subsidiaries reserve the right to make modifications, enhancements, improvements, corrections or other changes without further notice to this document and any product described herein. Diodes Incorporated does not assume any liability arising out of the application or use of this document or any product described herein; neither does Diodes Incorporated convey any license under its patent or trademark rights, nor the rights of others. Any Customer or user of this document or products described herein in such applications shall assume all risks of such use and will agree to hold Diodes Incorporated and all the companies whose products are represented on Diodes Incorporated website, harmless against all damages.

Diodes Incorporated does not warrant or accept any liability whatsoever in respect of any products purchased through unauthorized sales channel. Should Customers purchase or use Diodes Incorporated products for any unintended or unauthorized application, Customers shall indemnify and hold Diodes Incorporated and its representatives harmless against all claims, damages, expenses, and attorney fees arising out of, directly or indirectly, any claim of personal injury or death associated with such unintended or unauthorized application.

Products described herein may be covered by one or more United States, international or foreign patents pending. Product names and markings noted herein may also be covered by one or more United States, international or foreign trademarks.

This document is written in English but may be translated into multiple languages for reference. Only the English version of this document is the final and determinative format released by Diodes Incorporated.

**LIFE SUPPORT**

Diodes Incorporated products are specifically not authorized for use as critical components in life support devices or systems without the express written approval of the Chief Executive Officer of Diodes Incorporated. As used herein:

A. Life support devices or systems are devices or systems which:

1. are intended to implant into the body, or
2. support or sustain life and whose failure to perform when properly used in accordance with instructions for use provided in the labeling can be reasonably expected to result in significant injury to the user.

B. A critical component is any component in a life support device or system whose failure to perform can be reasonably expected to cause the failure of the life support device or to affect its safety or effectiveness.

Customers represent that they have all necessary expertise in the safety and regulatory ramifications of their life support devices or systems, and acknowledge and agree that they are solely responsible for all legal, regulatory and safety-related requirements concerning their products and any use of Diodes Incorporated products in such safety-critical, life support devices or systems, notwithstanding any devices- or systems-related information or support that may be provided by Diodes Incorporated. Further, Customers must fully indemnify Diodes Incorporated and its representatives against any damages arising out of the use of Diodes Incorporated products in such safety-critical, life support devices or systems.

Copyright © 2013, Diodes Incorporated

[www.diodes.com](http://www.diodes.com)

## Looking for pricing, stock, or lifecycle information?

Click below to explore more details on WIN SOURCE:

- ⊖ [View AZ1084D-1.5TRG1 on WIN SOURCE](#)
- ⊖ [Diodes Incorporated Information](#)

## Optimize Your Supply Chain with WIN SOURCE Solutions

- ✓ Global Sourcing Solution
- ✓ Obsolete Management
- ✓ Cost Control Management
- ✓ Shortage Management
- ✓ Alternative Solution
- ✓ Excess Inventory Management