

2A/1A Fixed Output LDO Regulators

BAxxDD0T Series BAxxCC0T Series BAxxCC0FP Series

2A/1A Fixed Output LDO Regulators With Shutdown Swicth

BAxxDD0WT Series BAxxDD0HFP Series BAxxCC0WT Series BAxxCC0WFP Series

●General Description

Standard Fixed Output LDO Regulators are low-saturation regulators, available for output s up to 2A / 1A. ROHM has a wide output voltage range and package lineup with and without shutdown switches. This IC has a built-in over-current protection circuit that prevents the destruction of the IC due to output short circuits, a thermal shut-down circuit that protects the IC from damage due to overloading and an over-voltage protection circuit that protects the IC from surges generated in the power supply line of the IC.

●Features

- $\pm 1\%$ highly accurate output voltage (BAxxDD0xx)
- Low saturation with PNP output
- Built-in over-current protection circuit that prevents the destruction of the IC due to output short circuits
- Built-in thermal shutdown circuit for protecting the IC from damage due to overloading
- Built-in over- voltage protection circuit that prevents the destruction of the IC due to power supply surges

●Key Specification

- Input Power Supply Voltage: 25V (Max.)
- Output voltage type: Fixed
- Output current: BAxxDD0xx series 2A (Max.)
BAxxCC0xx series 1A (Max.)
- Shutdown current: 0 μ A(Typ.)
- Operating temperature range: -40°C to +125°C

●Applications

Used in DSP power supplies for DVD and CD players, FPDs, televisions, personal computers or any other consumer device

●Packages

	W (Typ.) x D (Typ.) x H (Max.)
HRP5	9.395mm x 10.54mm x 2.005mm
TO252-3	6.50 mm x 9.50mm x 2.50 mm
TO252-5	6.50 mm x 9.50mm x 2.50 mm
TO220FP-3	10.00 mm x 30.50mm x 4.60 mm
TO220FP-5	10.00 mm x 30.50mm x 4.60 mm

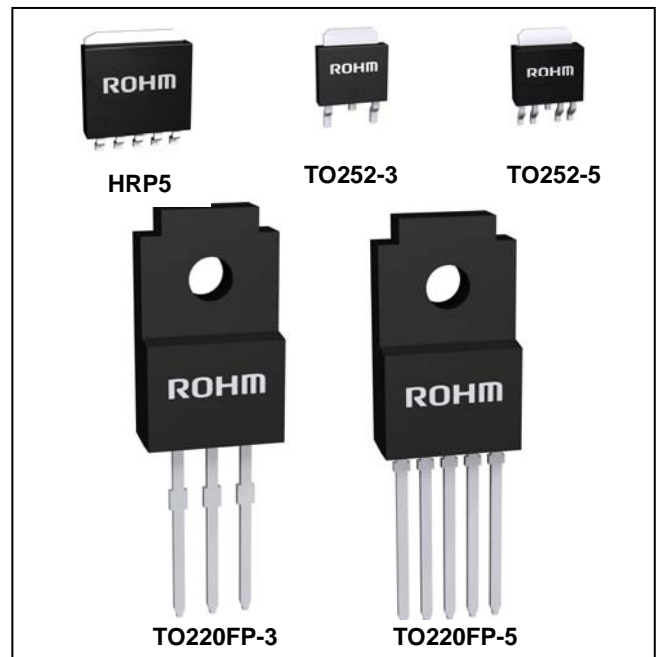

●Lineup matrix

■1A output BAxxCC0xx Series

Part Number	Output voltage (V)										Package
	3.0	3.3	5.0	6.0	7.0	8.0	9.0	10.0	12.0	15.0	
BAxxCC0WT	○	○	○	—	○	○	○	○	○	—	TO220FP-5
BAxxCC0WFP	—	○	○	○	○	○	○	—	○	—	TO252-5
BAxxCC0T	○	○	○	○	○	○	○	○	○	○	TO220FP-3
BAxxCC0FP	○	○	○	○	○	○	○	○	○	○	TO252-3

■2A output BAxxDD0xx Series

Part Number	Output voltage (V)									Package
	1.5	1.8	2.5	3.0	3.3	5.0	9.0	12.0	16.0	
BAxxDD0WT	○	○	○	○	○	○	○	○	○	TO220FP-5
BAxxDD0WHFP	○	○	○	○	○	○	○	○	○	HRP5
BAxxDD0T	○	○	○	○	○	○	○	○	○	TO220FP-3

○Product structure : Silicon monolithic integrated circuit ○This product is not designed protection against radioactive rays.

●Ordering Information

B A x x x x 0 x x x x											-	X X	
Part Number	Output voltage	Output Current CC0 : 1A DD0 : 2A	Shutdown Switch W : Includes switch None: without switch	Package HFP : HRP5 FP : TO252-5 : TO252-3 T : TO220FP-5 : TO220FP-3	Packaging and forming specification TR: Embossed tape and reel (HRP5) E2: Embossed tape and reel (TO252-3,TO252-5) None : Container Tube (TO220FP-3,TO220FP-5)								

●Lineup

■ 1A output BAxxCC0xx Series

Maximum output current (Max.)	Shutdown Switch	Package		Output voltage(Typ.)	Orderable Part Number	
1A	With Switch	TO252-5	Reel of 2000	3.3V	BA033CC0WFP-E2	
				5.0V	BA05CC0WFP-E2	
				6.0V	BA06CC0WFP-E2	
				7.0V	BA07CC0WFP-E2	
				8.0V	BA08CC0WFP-E2	
				9.0V	BA09CC0WFP-E2	
		12.0V	BAJ2CC0WFP-E2			
		TO220FP-5	Tube of 500	3.0V	BA03CC0WT	
				3.3V	BA033CC0WT	
				5.0V	BA05CC0WT	
				7.0V	BA07CC0WT	
				8.0V	BA08CC0WT	
				9.0V	BA09CC0WT	
		No switch	TO252-3	Reel of 2000	3.0V	BA03CC0FP-E2
					3.3V	BA033CC0FP-E2
					5.0V	BA05CC0FP-E2
					6.0V	BA06CC0FP-E2
					7.0V	BA07CC0FP-E2
	8.0V				BA08CC0FP-E2	
	9.0V				BA09CC0FP-E2	
	10.0V				BAJ0CC0FP-E2	
	12.0V				BAJ2CC0FP-E2	
	TO220FP-3		Tube of 500	3.0V	BA03CC0T	
				3.3V	BA033CC0T	
				5.0V	BA05CC0T	
				6.0V	BA06CC0T	
				7.0V	BA07CC0T	
				8.0V	BA08CC0T	
				9.0V	BA09CC0T	
				10.0V	BAJ0CC0T	
				12.0V	BAJ2CC0T	
	15.0V	BAJ5CC0T				

■ 2A output BAxxDD0xx Series

Maximum output current (Max.)	Shutdown Switch	Package		Output voltage(Typ.)	Orderable Part Number
2A	With Switch	TO220FP-5	Tube of 500	1.5V	BA15DD0WT
				1.8V	BA18DD0WT
				2.5V	BA25DD0WT
				3.0V	BA30DD0WT
				3.3V	BA33DD0WT
				5.0V	BA50DD0WT
				9.0V	BA90DD0WT
				12.0V	BAJ2DD0WT
				16.0V	BAJ6DD0WT
		HRP5	Reel of 2000	1.5V	BA15DD0WHFP-TR
				1.8V	BA18DD0WHFP-TR
				2.5V	BA25DD0WHFP-TR
				3.0V	BA30DD0WHFP-TR
				3.3V	BA33DD0WHFP-TR
				5.0V	BA50DD0WHFP-TR
				9.0V	BA90DD0WHFP-TR
				12.0V	BAJ2DD0WHFP-TR
				16.0V	BAJ6DD0WHFP-TR
	No switch	TO220FP-3	Tube of 500	1.5V	BA15DD0T
				1.8V	BA18DD0T
				2.5V	BA25DD0T
				3.0V	BA30DD0T
				3.3V	BA33DD0T
				5.0V	BA50DD0T
				9.0V	BA90DD0T
				12.0V	BAJ2DD0T
				16.0V	BAJ6DD0T

●Block Diagrams / Pin Configurations / Pin Descriptions

BAXxCC0WFP/ BAXxDD0WHFP/ BAXxCC0WT/ BAXxDD0WT

Fig.1

PIN No.	Pin Name	Function
1	CTL	Output voltage ON/OFF control
2	Vcc	Power supply voltage input
3	N.C./GND	Unconnected terminal/GND* ¹
4	OUT	Voltage output
5	N.C.	Unconnected terminal
Fin	GND	GND* ²

*¹ TO252-5=N.C., TO220FP-5, HRP5=GND
 *² TO252-5, HRP5 only

TOP VIEW

BAXxCC0T/ BAXxCC0FP/ BAXxDD0T

Fig.2

PIN No.	Pin Name	Function
1	Vcc	Power supply voltage input
2	N.C./GND	Unconnected terminal/GND* ¹
3	OUT	Voltage output
Fi	GND	GND* ²

*¹ TO252-3=N.C., TO220FP-3=GND
 *² TO252-3 only

TOP VIEW

● Absolute Maximum Ratings (Ta=25°C)

Parameter	Symbol	Ratings	Unit
Input Power Supply Voltage ^{*1}	V _{CC}	-0.3 to +35	V
Power Dissipation ^{*2}	Pd	2300(HRP5)	mW
		1300(TO252-5)	
		1200(TO252-3)	
		2000(TO220FP-3,5)	
Operating Temperature Range	Topr	-40 to +125	°C
Ambient Storage Temperature	Tstg	-55 to +150	°C
Junction Temperature	T _{JMAX.}	+150	°C
Output Control Terminal Voltage ^{*3}	V _{ctl}	-0.3 to +V _{CC}	V
Voltage Applied to the Tip ^{*4}	V _{CC peak}	+50	V

*1 Must not exceed Pd

*2 HRP5 : In cases in which Ta ≥ 25°C when a 70mm × 70mm × 1.6mm glass epoxy board is used, the power is reduced by 18.4 mW/°C.
 TO252FP-3 : In cases in which Ta ≥ 25°C when a 70mm × 70mm × 1.6mm glass epoxy board is used, the power is reduced by 9.6 mW/°C.
 TO252FP-5 : In cases in which Ta ≥ 25°C when a 70mm × 70mm × 1.6mm glass epoxy board is used, the power is reduced by 10.4 mW/°C.
 TO220FP-5 : No heat sink. When Ta ≥ 25°C, the power is reduced by 16 mW/°C.

*3 Only for models with shutdown switches.

*4 Applied voltage : 200msec or less (tr ≥ 1msec)



● Recommended Operating Ratings (Ta=25°C)

Parameter		Symbol	Ratings			Unit
			Min.	Typ.	Max.	
Input Power Supply Voltage	BAXxCC0xx	V _{CC}	4.0	—	25.0	V
	BAXxDD0xx		3.0	—	25.0	V
Output Current	BAXxCC0xx	I _o	—	—	1	A
	BAXxDD0xx		—	—	2	A
Output Control Terminal Voltage		V _{ctl}	0	—	V _{CC}	V

●Electrical Characteristics

BAXxCC0 Series (Unless otherwise specified, Ta=25°C, VCTL=5V, Io=500mA Setting *5)

Parameter	Symbol	Limit			Unit	Conditions
		Min.	Typ.	Max.		
Output Voltage *6	Vo	Vo(T) × 0.98	Vo(T)	Vo(T) × 1.02	V	
Shut Down Current	I _{sd}	—	0	10	μA	V _{CTL} =0V
Bias Current	I _b	—	2.5	5.0	mA	V _{CTL} =2V, I _o =0mA
Dropout Voltage	ΔV _d	—	0.3	0.5	V	V _{CC} =Vo × 0.95
Peak Output Current	I _o	1.0	—	—	A	
Ripple Rejection	R.R.	45	55	—	dB	f=120Hz, e _{in} *7=1Vrms, I _o =100mA
Line Regulation	Reg.I	—	20	100	mV	V _{CC} =Vo(T)+1→25V
Load Regulation	Reg.L	—	50	150	mV	I _o =5mA→1A
Temperature Coefficient of Output Voltage *8	T _{cvo}	—	±0.02	—	%/°C	I _o =5mA, T _j =0 to 125°C
Output Short Current	I _{os}	—	0.40	—	A	V _{CC} =25V
ON Mode Voltage	V _{thH}	2.0	—	—	V	ACTIVE MODE, I _o =0mA
OFF Mode Voltage	V _{thL}	—	—	0.8	V	OFF MODE, I _o =0mA
Input High Current	I _{CTL}	100	200	300	μA	V _{CTL} =5V, I _o =0mA

BAXxDD0 series (Unless otherwise specified, Ta=25°C, VCTL=3V, VCC=V_{CCCT}*9)

Parameter	Symbol	Limit			Unit	Conditions
		Min.	Typ.	Max.		
Shut Down Current	I _{sd}	—	0	10	μA	V _{CTL} =0V, I _o =0mA
Bias Current	I _b	—	0.9	2.0	mA	I _o =0mA
Output Voltage *10	Vo	V _{otyp} × 0.99	V _{otyp}	V _{otyp} × 1.01	V	I _o =200mA
Dropout Voltage 1 *11	ΔV _{d1}	—	0.3	0.5	V	V _{CC} =0.95 × Vo, I _o =1A
Dropout Voltage 2 *11	ΔV _{d2}	—	0.45	0.7	V	V _{CC} =0.95 × Vo, I _o =2A
Peak Output Current	I _o	2.0	—	—	A	
Ripple Rejection	R.R.	—	55	—	dB	f=120Hz, e _{in} *7=-20dBV, I _o =100mA
Line Regulation	Reg.I	—	15	50	mV	V _{CC} =V _{CCCT} *9V→25V, I _o =200mA
Load Regulation	Reg.L	—	50	200	mV	I _o =0mA→2A
Temperature Coefficient of Output Voltage *8	T _{cvo}	—	±0.02	—	%/°C	I _o =5mA, T _j =0 to 125°C
CTL ON Mode Voltage	V _{on}	2.0	—	V _{CC}	V	ACTIVE MODE, I _o =0mA
CTL OFF Mode Voltage	V _{off}	—	—	0.8	V	OFF MODE, I _o =0mA
CTL Input Current	I _{CTL}	—	60	120	μA	V _{CTL} =3V, I _o =0mA

*5 Vo=3.0V:V_{CC}=8.0V, 3.3V:V_{CC}=8.3V, Vo=5V:V_{CC}=10V, Vo=6V:V_{CC}=11V, Vo=7V:V_{CC}=12V, Vo=8V:V_{CC}=13V, Vo=9V:V_{CC}=14V, Vo=12V:V_{CC}=17V, Vo=15V:V_{CC}=20V

*6 Vo(T)=3.0, 3.3, 5.0, 6.0, 7.0, 8.0, 9.0, 12, 15V

*7 e_{in} : Input Voltage Ripple

*8 Not 100% tested

*9 Vo=1.5V, 1.8V, 2.5V, 3.0V : V_{CCCT} =4.0V, Vo=3.3V, 5.0V : V_{CCCT} =7.0V, Vo=9V : V_{CCCT} =12.0V, Vo=12V : V_{CCCT} =14.0V, Vo=16V : V_{CCCT} =18.0V)

*10 V_{otyp}=1.5V, 1.8V, 2.5V, 3.0V, 3.3V, 5.0V, 9.0V, 12.0V, 16.0V

*11 Vo≥3.0V

● Typical Performance Curves

(Unless specified otherwise, $V_{CC}=8.3V$, $V_o=3.3V$, $V_{CTL}=5.0V$, and $I_o=0mA$)
 BAxxCC0xx (BA33CC0WT)



Fig.3
Circuit current

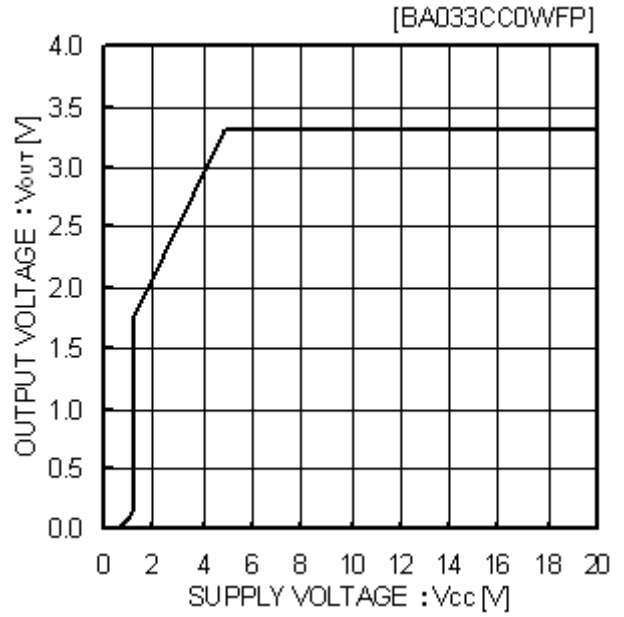

Fig.4
Input Stability



Fig.5
Input Stability
($I_o=500mA$)



Fig.6
Load Stability

● Typical Performance Curves - continued



Fig.7
Input/Output Voltage Difference
 I_o - ΔV_d Characteristics ($V_{cc}=2.95V$)

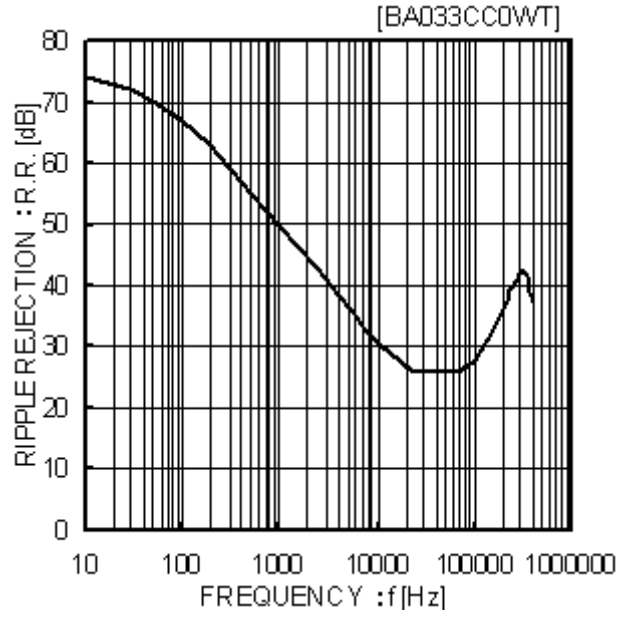

Fig.8
Ripple Rejection Characteristics
($I_o=100mA$)



Fig.9
Output Voltage
Temperature Characteristics

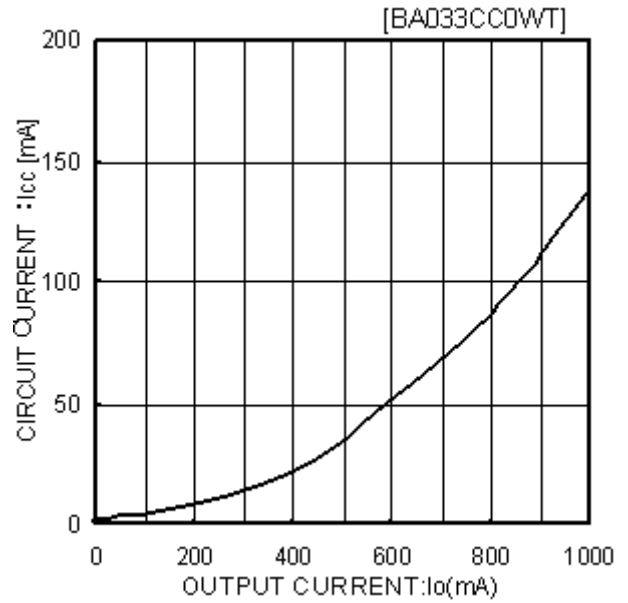

Fig.10
Circuit Current by load Level
($I_{out}=0mA \rightarrow 1A$)

● Typical Performance Curves - continued

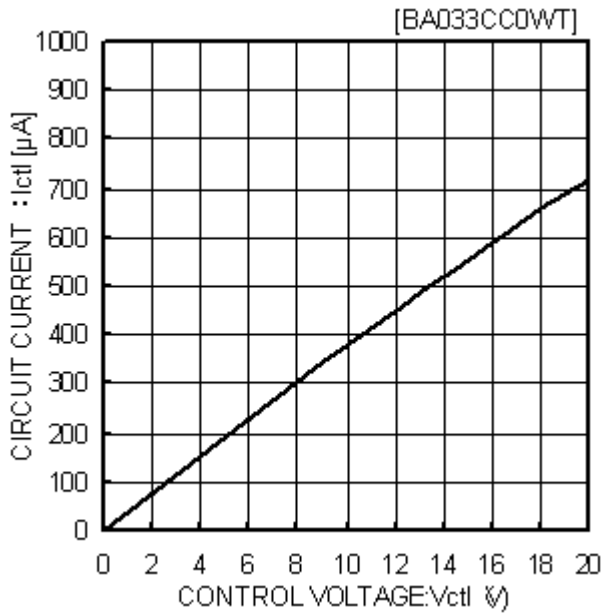

Fig.11
CTL Voltage vs. CTL Current



Fig.12
CTL Voltage vs. Output Voltage



Fig.13
Overvoltage Operating
Characteristics (I_o=200mA)

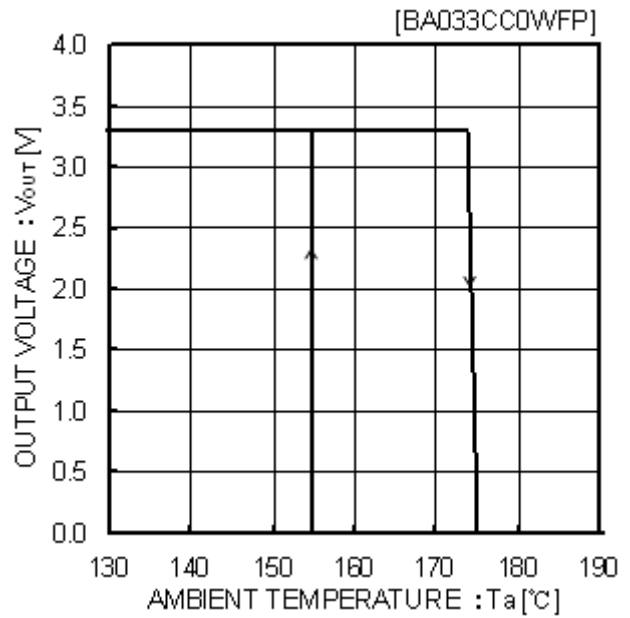

Fig.14
Thermal Shutdown
Circuit Characteristics

● Typical Performance Curves - continued

(Unless specified otherwise, $V_{CC}=7.0V$, $V_O=5.0V$, $V_{CTL}=3.0V$, and $I_O=0mA$)
 BAxxDD0xx (BA50DD0WT)

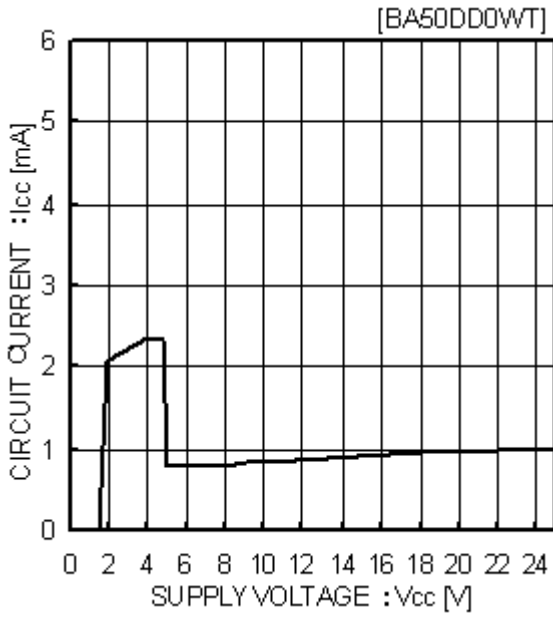

Fig.15
Circuit Current

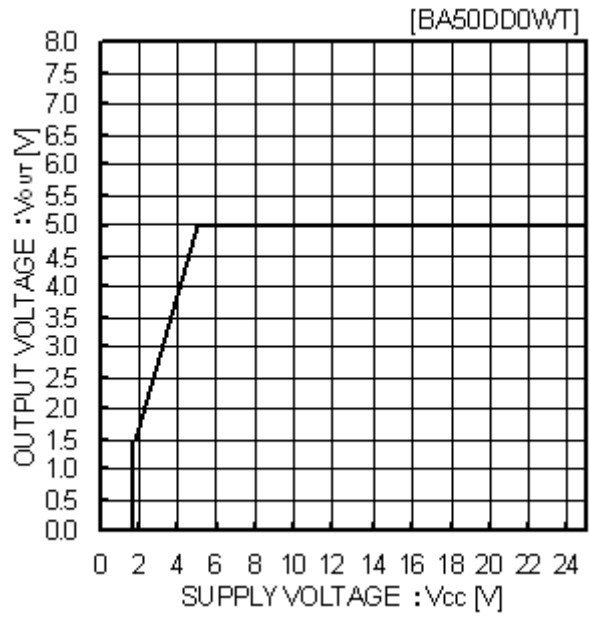

Fig.16
Input Stability ($I_O=0mA$)

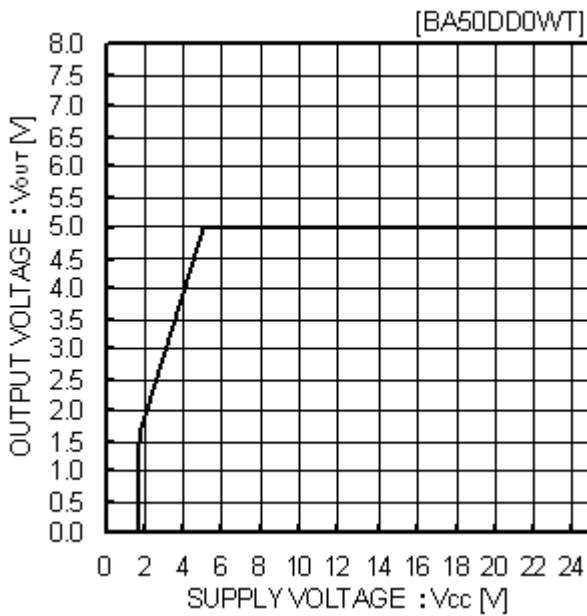

Fig.17
Input Stability ($I_O=2A$)

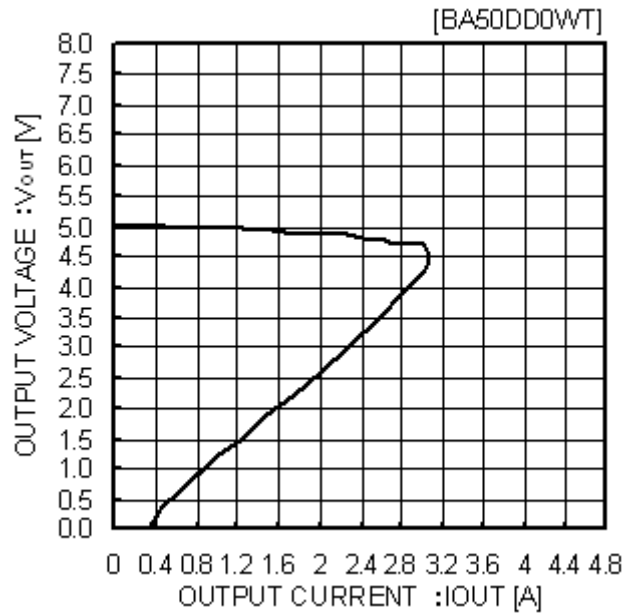

Fig.18
Load Stability

● Typical Performance Curves - continued



Fig.19
Input/Output Voltage Difference

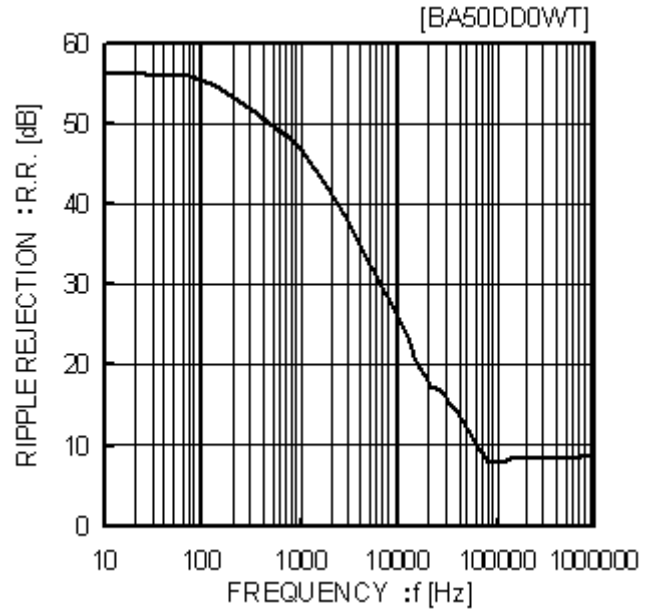

Fig.20
Ripple Rejection Characteristics



Fig.21
Temperature Characteristics

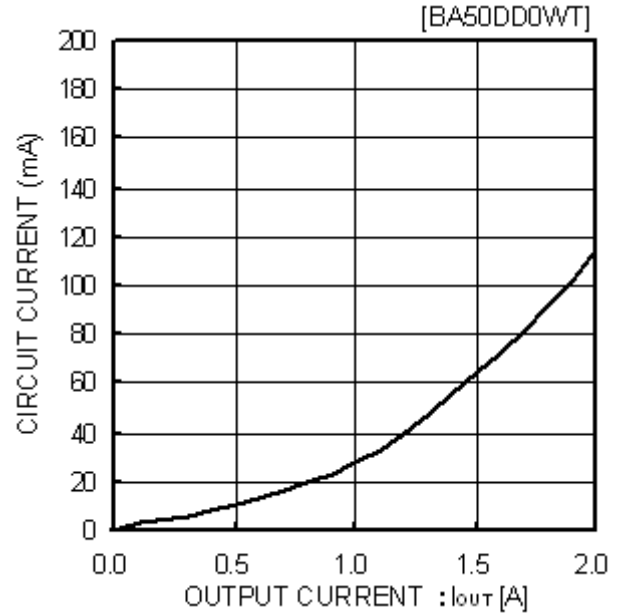

Fig.22
Circuit Current by Load Level
($I_{OUT}=0mA \rightarrow 2A$)

● Typical Performance Curves - continued



Fig.23
CTL Voltage vs. CTL Current

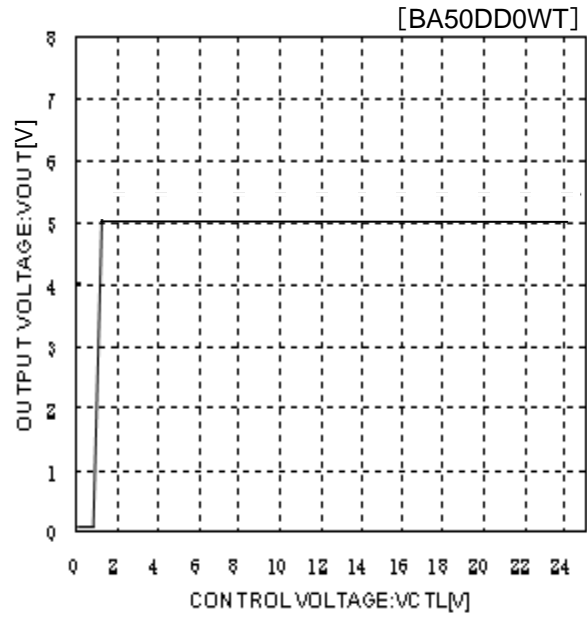

Fig.24
CTL Voltage vs. Output Voltage

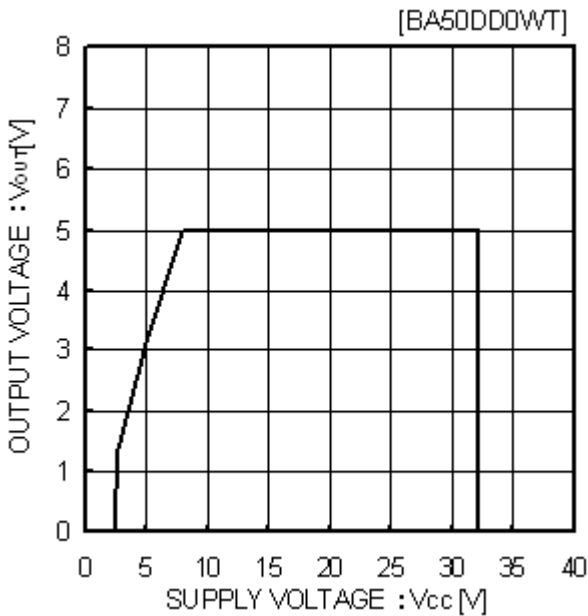

Fig.25
Overvoltage Operating
(Io=200mA)

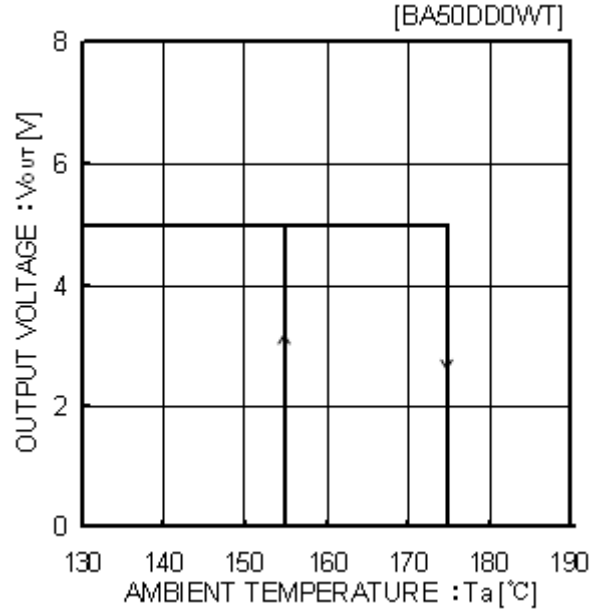

Fig.26
Thermal Shutdown
Circuit Characteristics

● I/O equivalence circuit

<BAxxDD0xx Series>



Fig.27

<BAxxCC0xx Series>



Fig.28

● Power Dissipation

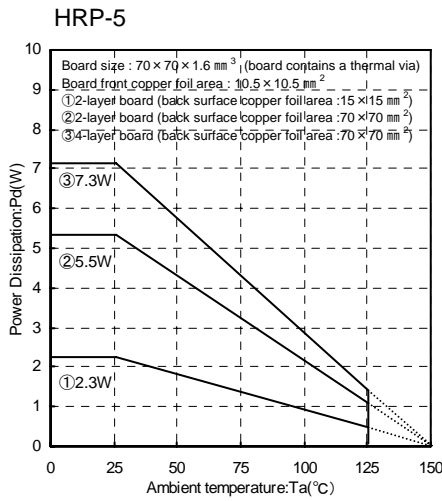

Fig.29

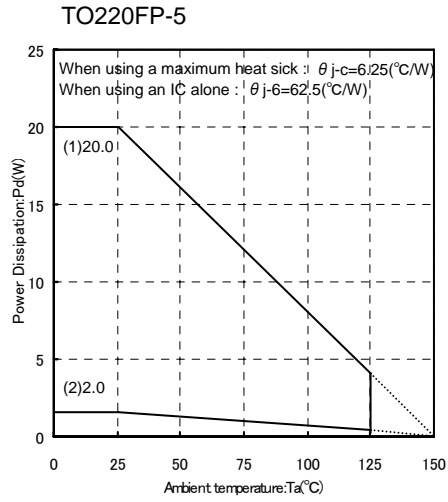

Fig.30



Fig.31

When using at temperatures over $T_a=25^{\circ}\text{C}$, please refer to the heat reducing characteristics shown in Fig.29 through 31. The IC characteristics are closely related to the temperature at which the IC is used and if the temperature exceeds the maximum junction temperature $T_{j\text{MAX}}$, the elements may be damaged or destroyed. From the standpoints of instantaneous destruction and long-term operating reliability, it is necessary give sufficient consideration to IC heat. In order to protect the IC from thermal damage, it is necessary to operate it at temperatures lower than the maximum junction temperature $T_{j\text{MAX}}$ of the IC.

Fig.30 shows the acceptable loss and heat reducing characteristics of the TO220FP package. The portion shown by the diagonal line is the acceptable loss range that can be used with the IC alone. Even when the ambient temperature T_a is a normal temperature (25°C), the chip (junction) temperature T_j may be quite high so please operate the IC at temperatures less than the acceptable loss P_d .

The method of calculating the power consumption P_c (W) is as follows.

$$P_c = (V_{cc}-V_o) \times I_o + V_{cc} \times I_{cca}$$

Acceptable loss $P_d \leq P_c$

V_{cc} : Input voltage
 V_o : Output voltage
 I_o : Load current
 I_{cca} : Circuit current

Solving this for load current I_o in order to operate within the acceptable loss:

$$I_o \leq \frac{P_d - V_{cc} \times I_{cca}}{V_{cc} - V_o}$$

(Please refer to Fig.10 and 22 for I_{cca} .)

It is then possible to find the maximum load current $I_{o\text{MAX}}$ with respect to the applied voltage V_{cc} at the time of thermal design.

• Calculation Example

Example 1) When $T_a=85^{\circ}\text{C}$, $V_{cc}=8.3\text{V}$, $V_o=3.3\text{V}$, BA33DD0WT

$$I_o \leq \frac{1.04 - 8.3 \times I_{cca}}{5}$$

$I_o \leq 200\text{mA}$ ($I_{cca} : 2\text{mA}$)

(With the IC alone : $\theta_{ja}=62.5^{\circ}\text{C/W} \rightarrow -16\text{mW}/^{\circ}\text{C}$
 $25^{\circ}\text{C}=2000\text{mW} \rightarrow 85^{\circ}\text{C}=1040\text{mW}$)

Please refer to the above information and keep thermal designs within the scope of acceptable loss for all operating temperature ranges.

The power consumption P_c of the IC when there is a short circuit (short between V_o and GND) is:

$$P_c = V_{cc} \times (I_{cca} + I_{\text{short}})$$

* I_{short} : Short circuit current

● Peripheral Circuit Considerations

• V_{cc} Terminal

Please attach a capacitor (greater than $0.33\mu\text{F}$) between the V_{cc} and GND.

The capacitance values will differ depending on the application, so please take this into account when configuring the terminal.

• GND Terminal

Please be sure to keep the set ground and IC ground at the same potential level so that a potential difference does not arise between them.

If a potential difference arises between the set ground and the IC ground, the preset voltage will not be outputted, causing the system to become unstable. Therefore, please reduce the impedance by making the ground patterns as wide as possible and by reducing the distance between the set ground and the IC ground as much as possible.

• CTL Terminal

The CTL terminal is turned ON at 2.0V and higher and OFF at 0.8V and lower within the operating power supply voltage range. CC0xx series, the power supply and the CTL terminal in any order without problems.

● V_o Terminal



Fig.32 Output Equivalent Circuit



Fig.33 ESR-Io Characteristics (BAxxCC0)

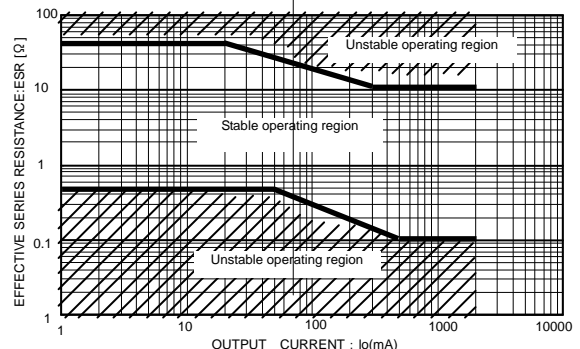

Fig.34 ESR vs. I_o Characteristics (BAxxDD0)

Please attach an anti-oscillation capacitor between V_o and GND. The capacitance of the capacitor may significantly change due to factors such as temperature changes, making it impossible to completely stop oscillations. Please use a tantalum capacitor or aluminum electrolysis capacitor with favorable characteristics and small internal series resistance (ESR) even at low temperatures. The output fluctuates regardless of whether the ESR is large or small. Please use the IC within the stable operating region while referring to the ESR characteristics reference data shown in Fig.32 through 34. In applications where there are sudden load fluctuations, the use of a capacitor with large capacitance is recommended.

●Operational Notes

1) Protection Circuits

Over-current Protection Circuit

A built-in over-current protection circuit corresponding to the current capacity prevents the destruction of the IC when there are load shorts. This protection circuit is a “7”-shaped current control circuit that is designed such that the current is restricted and does not latch even when a large current momentarily flows through the system with a high-capacitance capacitor. However, while this protection circuit is effective for the prevention of destruction due to unexpected accidents, it is not suitable for continuous operation or transient use. Please be aware when creating thermal designs that the overcurrent protection circuit has negative current capacity characteristics with regard to temperature (Refer to Fig.6 and 18).

Thermal Shutdown Circuit (Thermal Protection)

This system has a built-in temperature protection circuit for the purpose of protecting the IC from thermal damage. As shown above, this must be used within the range of acceptable loss, but if the acceptable loss happens to be continuously exceeded, the chip temperature T_j increases, causing the temperature protection circuit to operate. When the thermal shutdown circuit operates, the operation of the circuit is suspended. The circuit resumes operation immediately after the chip temperature T_j decreases, so the output repeats the ON and OFF states (Please refer to Fig.14 and 26 for the temperatures at which the temperature protection circuit operates). There are cases in which the IC is destroyed due to thermal runaway when it is left in the overloaded state. Be sure to avoid leaving the IC in the overloaded state.

Reverse Current

In order to prevent the destruction of the IC when a reverse current flows through the IC, it is recommended that a diode be placed between the Vcc and Vo and a pathway be created so that the current can escape (Refer to Fig.35).



Fig.35 Bypass diode

- 2) This IC is bipolar IC that has a P-board (substrate) and P+ isolation layer between each device, as shown in Fig.36. A P-N junction is formed between this P-layer and the N-layer of each device, and the P-N junction operates as a parasitic diode when the electric potential relationship is $GND > Pin A$, $GND > Pin B$, while it operates as a parasitic transistor when the electric potential relationship is $Pin B > GND > Pin A$. Parasitic devices are structurally inevitable in the IC. The operation of parasitic devices induces mutual interference between circuits, causing malfunctions and eventually the destruction of the IC. It is necessary to be careful not to use the IC in ways that would cause parasitic elements to operate. For example, applying a voltage that is lower than the GND (P-board) to the input terminal.

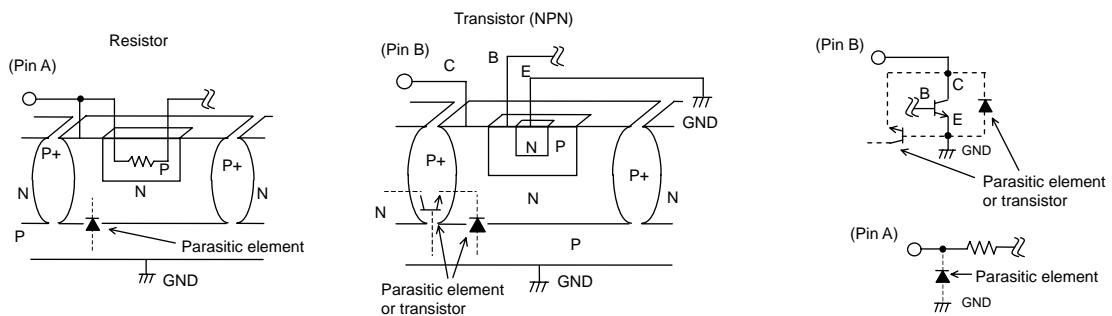

Fig.36 Example of the basic structure of a bipolar IC

Status of this document

The Japanese version of this document is formal specification. A customer may use this translation version only for a reference to help reading the formal version.

If there are any differences in translation version of this document formal version takes priority.

●Physical Dimension Tape and Reel Information

HRP5

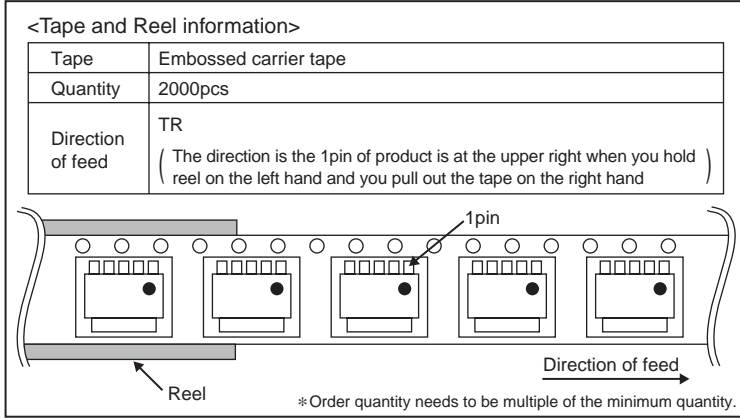
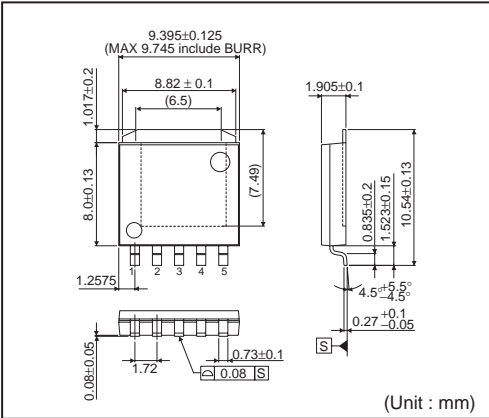

TO252-3

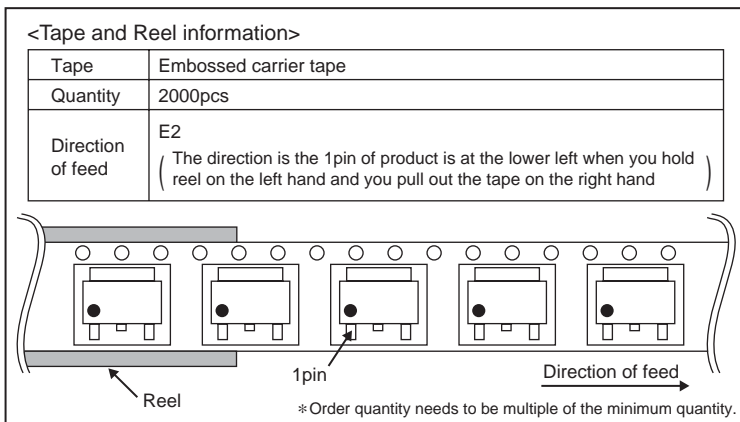
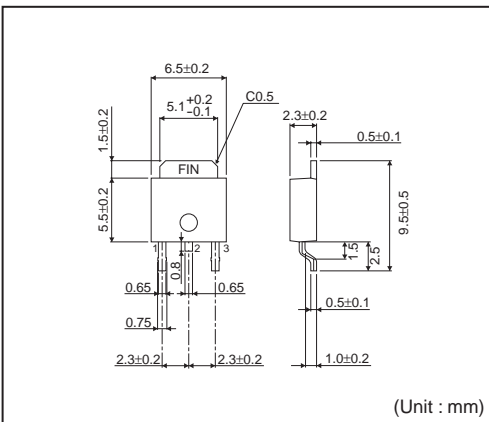

TO252-5

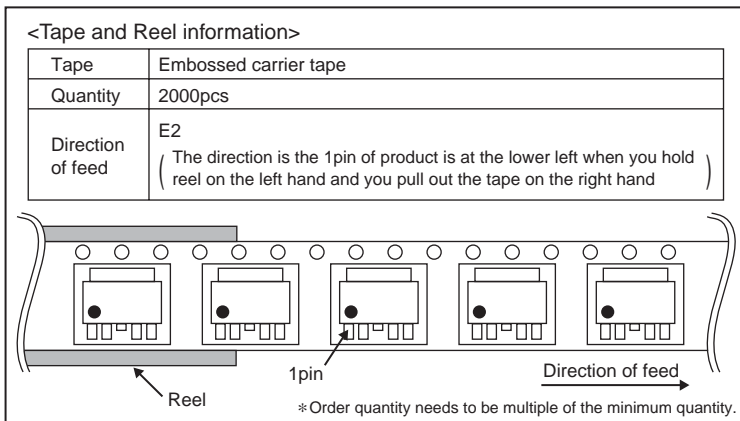
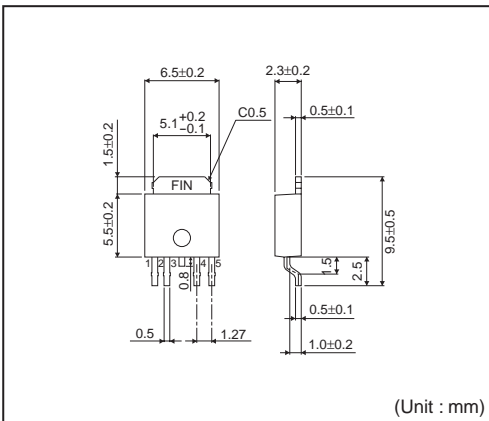

TO220FP-3

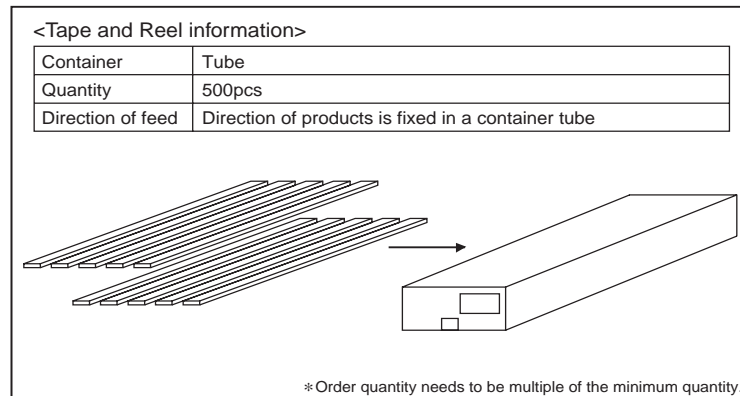
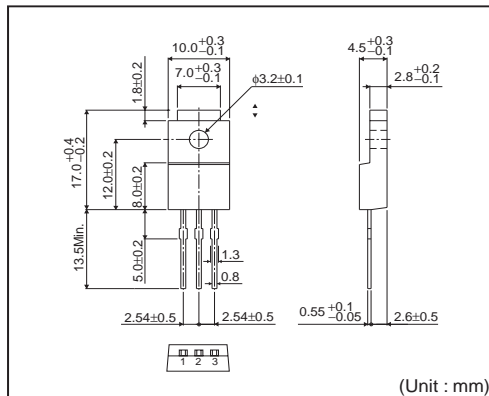

TO220FP-5

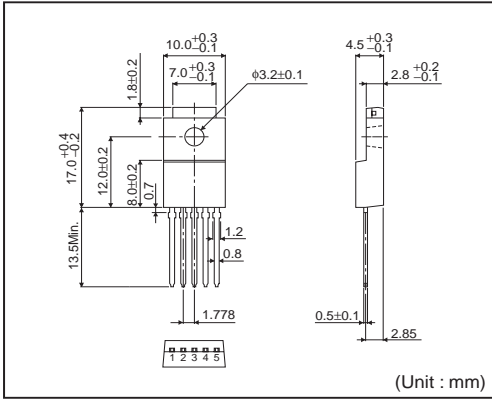

<Tape and Reel information>

Container	Tube
Quantity	500pcs
Direction of feed	Direction of products is fixed in a container tube



* Order quantity needs to be multiple of the minimum quantity.

●Marking Diagrams

HRP5 (TOP VIEW)



TO252-3 (TOP VIEW)

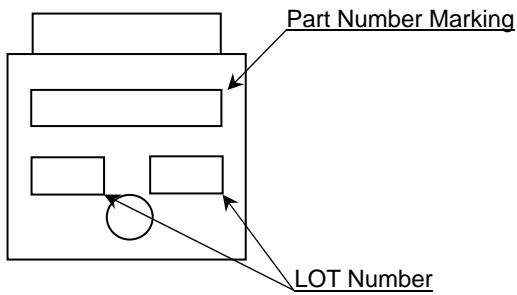

TO252-5 (TOP VIEW)



TO220FP-3 (TOP VIEW)



TO220FP-5 (TOP VIEW)



■ 1A output BAxxCC0xx Series

Orderable Part Number	Package	Part Number Marking
BA033CC0WFP-E2	TO252-5	033CC0W
BA05CC0WFP-E2		05CC0W
BA06CC0WFP-E2		06CC0W
BA07CC0WFP-E2		07CC0W
BA08CC0WFP-E2		08CC0W
BA09CC0WFP-E2		09CC0W
BAJ2CC0WFP-E2		J2CC0W
BA03CC0WT	TO220FP-5	03CC0W
BA033CC0WT		033CC0W
BA05CC0WT		05CC0W
BA07CC0WT		07CC0W
BA08CC0WT		08CC0W
BA09CC0WT		09CC0W
BAJ0CC0WT		J0CC0W
BAJ2CC0WT	J2CC0W	
BA03CC0FP-E2	TO252-3	03CC0
BA033CC0FP-E2		033CC0
BA05CC0FP-E2		05CC0
BA06CC0FP-E2		06CC0
BA07CC0FP-E2		07CC0
BA08CC0FP-E2		08CC0
BA09CC0FP-E2		09CC0
BAJ0CC0FP-E2		J0CC0
BAJ2CC0FP-E2		J2CC0
BAJ5CC0FP-E2	J5CC0	
BA03CC0T	TO220FP-3	03CC0
BA033CC0T		033CC0
BA05CC0T		05CC0
BA06CC0T		06CC0
BA07CC0T		07CC0
BA08CC0T		08CC0
BA09CC0T		09CC0
BAJ0CC0T		J0CC0
BAJ2CC0T		J2CC0
BAJ5CC0T	J5CC0	

■ 2A output BAxxDD0xx Series

Orderable Part Number	Package	Part Number Marking
BA15DD0WT	TO220FP-5	15DD0W
BA18DD0WT		18DD0W
BA25DD0WT		25DD0W
BA30DD0WT		30DD0W
BA33DD0WT		33DD0W
BA50DD0WT		50DD0W
BA90DD0WT		90DD0W
BAJ2DD0WT		J2DD0W
BAJ6DD0WT		J6DD0W
BA15DD0WHFP-TR		HRP5
BA18DD0WHFP-TR	18DD0W	
BA25DD0WHFP-TR	25DD0W	
BA30DD0WHFP-TR	30DD0W	
BA33DD0WHFP-TR	33DD0W	
BA50DD0WHFP-TR	50DD0W	
BA90DD0WHFP-TR	90DD0W	
BAJ2DD0WHFP-TR	J2DD0W	
BAJ6DD0WHFP-TR	J6DD0W	
BA15DD0T	TO220FP-3	
BA18DD0T		18DD0
BA25DD0T		25DD0
BA30DD0T		30DD0
BA33DD0T		33DD0
BA50DD0T		50DD0
BA90DD0T		90DD0
BAJ2DD0T		J2DD0
BAJ6DD0T		J6DD0

●Revision History

Date	Revision	Changes
26.Jun.2012	001	New Release
25.July.2013	002	Page-14 Changed CTL terminal description
9.Aug.2013	003	Page-6 Added comment "Vo=3.0C:Vcc=8.0V", "Vo=15V:Vcc=20V" in *5 Page-6 Added comment "3", "15V" in *6

Notice

Precaution on using ROHM Products

- Our Products are designed and manufactured for application in ordinary electronic equipments (such as AV equipment, OA equipment, telecommunication equipment, home electronic appliances, amusement equipment, etc.). If you intend to use our Products in devices requiring extremely high reliability (such as medical equipment ^(Note 1), transport equipment, traffic equipment, aircraft/spacecraft, nuclear power controllers, fuel controllers, car equipment including car accessories, safety devices, etc.) and whose malfunction or failure may cause loss of human life, bodily injury or serious damage to property ("Specific Applications"), please consult with the ROHM sales representative in advance. Unless otherwise agreed in writing by ROHM in advance, ROHM shall not be in any way responsible or liable for any damages, expenses or losses incurred by you or third parties arising from the use of any ROHM's Products for Specific Applications.

(Note1) Medical Equipment Classification of the Specific Applications

JAPAN	USA	EU	CHINA
CLASS III	CLASS III	CLASS II b	CLASS III
CLASS IV		CLASS III	

- ROHM designs and manufactures its Products subject to strict quality control system. However, semiconductor products can fail or malfunction at a certain rate. Please be sure to implement, at your own responsibilities, adequate safety measures including but not limited to fail-safe design against the physical injury, damage to any property, which a failure or malfunction of our Products may cause. The following are examples of safety measures:
 - Installation of protection circuits or other protective devices to improve system safety
 - Installation of redundant circuits to reduce the impact of single or multiple circuit failure
- Our Products are designed and manufactured for use under standard conditions and not under any special or extraordinary environments or conditions, as exemplified below. Accordingly, ROHM shall not be in any way responsible or liable for any damages, expenses or losses arising from the use of any ROHM's Products under any special or extraordinary environments or conditions. If you intend to use our Products under any special or extraordinary environments or conditions (as exemplified below), your independent verification and confirmation of product performance, reliability, etc. prior to use, must be necessary:
 - Use of our Products in any types of liquid, including water, oils, chemicals, and organic solvents
 - Use of our Products outdoors or in places where the Products are exposed to direct sunlight or dust
 - Use of our Products in places where the Products are exposed to sea wind or corrosive gases, including Cl₂, H₂S, NH₃, SO₂, and NO₂
 - Use of our Products in places where the Products are exposed to static electricity or electromagnetic waves
 - Use of our Products in proximity to heat-producing components, plastic cords, or other flammable items
 - Sealing or coating our Products with resin or other coating materials
 - Use of our Products without cleaning residue of flux (even if you use no-clean type fluxes, cleaning residue of flux is recommended); or Washing our Products by using water or water-soluble cleaning agents for cleaning residue after soldering
 - Use of the Products in places subject to dew condensation
- The Products are not subject to radiation-proof design.
- Please verify and confirm characteristics of the final or mounted products in using the Products.
- In particular, if a transient load (a large amount of load applied in a short period of time, such as pulse. is applied, confirmation of performance characteristics after on-board mounting is strongly recommended. Avoid applying power exceeding normal rated power; exceeding the power rating under steady-state loading condition may negatively affect product performance and reliability.
- De-rate Power Dissipation (Pd) depending on Ambient temperature (Ta). When used in sealed area, confirm the actual ambient temperature.
- Confirm that operation temperature is within the specified range described in the product specification.
- ROHM shall not be in any way responsible or liable for failure induced under deviant condition from what is defined in this document.

Precaution for Mounting / Circuit board design

- When a highly active halogenous (chlorine, bromine, etc.) flux is used, the residue of flux may negatively affect product performance and reliability.
- In principle, the reflow soldering method must be used; if flow soldering method is preferred, please consult with the ROHM representative in advance.

For details, please refer to ROHM Mounting specification

Precautions Regarding Application Examples and External Circuits

1. If change is made to the constant of an external circuit, please allow a sufficient margin considering variations of the characteristics of the Products and external components, including transient characteristics, as well as static characteristics.
2. You agree that application notes, reference designs, and associated data and information contained in this document are presented only as guidance for Products use. Therefore, in case you use such information, you are solely responsible for it and you must exercise your own independent verification and judgment in the use of such information contained in this document. ROHM shall not be in any way responsible or liable for any damages, expenses or losses incurred by you or third parties arising from the use of such information.

Precaution for Electrostatic

This Product is electrostatic sensitive product, which may be damaged due to electrostatic discharge. Please take proper caution in your manufacturing process and storage so that voltage exceeding the Products maximum rating will not be applied to Products. Please take special care under dry condition (e.g. Grounding of human body / equipment / solder iron, isolation from charged objects, setting of ionizer, friction prevention and temperature / humidity control).

Precaution for Storage / Transportation

1. Product performance and soldered connections may deteriorate if the Products are stored in the places where:
 - [a] the Products are exposed to sea winds or corrosive gases, including Cl₂, H₂S, NH₃, SO₂, and NO₂
 - [b] the temperature or humidity exceeds those recommended by ROHM
 - [c] the Products are exposed to direct sunshine or condensation
 - [d] the Products are exposed to high Electrostatic
2. Even under ROHM recommended storage condition, solderability of products out of recommended storage time period may be degraded. It is strongly recommended to confirm solderability before using Products of which storage time is exceeding the recommended storage time period.
3. Store / transport cartons in the correct direction, which is indicated on a carton with a symbol. Otherwise bent leads may occur due to excessive stress applied when dropping of a carton.
4. Use Products within the specified time after opening a humidity barrier bag. Baking is required before using Products of which storage time is exceeding the recommended storage time period.

Precaution for Product Label

QR code printed on ROHM Products label is for ROHM's internal use only.

Precaution for Disposition

When disposing Products please dispose them properly using an authorized industry waste company.

Precaution for Foreign Exchange and Foreign Trade act

Since our Products might fall under controlled goods prescribed by the applicable foreign exchange and foreign trade act, please consult with ROHM representative in case of export.

Precaution Regarding Intellectual Property Rights

1. All information and data including but not limited to application example contained in this document is for reference only. ROHM does not warrant that foregoing information or data will not infringe any intellectual property rights or any other rights of any third party regarding such information or data. ROHM shall not be in any way responsible or liable for infringement of any intellectual property rights or other damages arising from use of such information or data.:
2. No license, expressly or implied, is granted hereby under any intellectual property rights or other rights of ROHM or any third parties with respect to the information contained in this document.

Other Precaution



1. This document may not be reprinted or reproduced, in whole or in part, without prior written consent of ROHM.
2. The Products may not be disassembled, converted, modified, reproduced or otherwise changed without prior written consent of ROHM.
3. In no event shall you use in any way whatsoever the Products and the related technical information contained in the Products or this document for any military purposes, including but not limited to, the development of mass-destruction weapons.
4. The proper names of companies or products described in this document are trademarks or registered trademarks of ROHM, its affiliated companies or third parties.

General Precaution

1. Before you use our Products, you are requested to carefully read this document and fully understand its contents. ROHM shall not be in any way responsible or liable for failure, malfunction or accident arising from the use of any ROHM's Products against warning, caution or note contained in this document.
2. All information contained in this document is current as of the issuing date and subject to change without any prior notice. Before purchasing or using ROHM's Products, please confirm the latest information with a ROHM sales representative.
3. The information contained in this document is provided on an "as is" basis and ROHM does not warrant that all information contained in this document is accurate and/or error-free. ROHM shall not be in any way responsible or liable for any damages, expenses or losses incurred by you or third parties resulting from inaccuracy or errors of or concerning such information.

Looking for pricing, stock, or lifecycle information?

Click below to explore more details on WIN SOURCE:

-  [View BAJ2CC0WT on WIN SOURCE](#)
-  [Rohm Semiconductor](#) Information

Optimize Your Supply Chain with WIN SOURCE Solutions

-  Global Sourcing Solution
-  Obsolete Management
-  Cost Control Management
-  Shortage Management
-  Alternative Solution
-  Excess Inventory Management