



**THE DATASHEET OF
BLC8G27LS-210PVY**



BLC8G27LS-210PV

Power LDMOS transistor

Rev. 4 — 24 November 2017

AMMPLÉON

Product data sheet

1. Product profile

1.1 General description

200 W LDMOS power transistor with improved video bandwidth for base station applications at frequencies from 2500 MHz to 2700 MHz.

Table 1. Typical performance

Typical RF performance at $T_{case} = 25\text{ °C}$ in a common source class-AB production test circuit.

Test signal	f	I_{DQ}	V_{DS}	$P_{L(AV)}$	G_p	η_D	$ACPR_{5M}$
	(MHz)	(mA)	(V)	(W)	(dB)	(%)	(dBc)
2-carrier W-CDMA	2600 to 2700	1730	28	65	17	30	-29 [1]

[1] Test signal: 3GPP test model 1; 64 DPCH; PAR = 8.4 dB at 0.01 % probability on CCDF per carrier; 5 MHz carrier spacing.

1.2 Features and benefits

- Excellent ruggedness
- High efficiency
- Low thermal resistance providing excellent thermal stability
- Decoupling leads to enable improved video bandwidth performance (150 MHz typical)
- Designed for broadband operation (2500 MHz to 2700 MHz)
- Lower output capacitance for improved performance in Doherty applications
- Designed for low memory effects providing excellent pre-distortability
- Internally matched for ease of use
- Integrated ESD protection
- Compliant to Directive 2002/95/EC, regarding Restriction of Hazardous Substances (RoHS)

1.3 Applications

- RF power amplifiers for base stations and multi carrier applications in the 2500 MHz to 2700 MHz frequency range

2. Pinning information

Table 2. Pinning

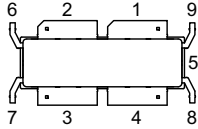
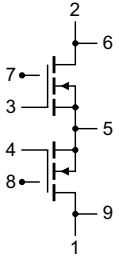
Pin	Description	Simplified outline	Graphic symbol
1	drain2		
2	drain1		
3	gate1		
4	gate2		
5	source [1]		
6	video decoupling drain1		
7	n.c.		
8	n.c.		
9	video decoupling drain2		

[1] Connected to flange.

3. Ordering information

Table 3. Ordering information

Type number	Package		
	Name	Description	Version
BLC8G27LS-210PV	-	air cavity plastic earless flanged package; 8 leads	SOT1251-1

4. Limiting values

Table 4. Limiting values

In accordance with the Absolute Maximum Rating System (IEC 60134).

Symbol	Parameter	Conditions	Min	Max	Unit
V_{DS}	drain-source voltage		-	65	V
V_{GS}	gate-source voltage		-0.5	+13	V
T_{stg}	storage temperature		-65	+150	°C
T_j	junction temperature [1]		-	225	°C

[1] Continuous use at maximum temperature will affect the reliability, for details refer to the online MTF calculator.

5. Thermal characteristics

Table 5. Thermal characteristics

Symbol	Parameter	Conditions	Typ	Unit
$R_{th(j-c)}$	thermal resistance from junction to case	$T_{case} = 80\text{ °C}; P_L = 65\text{ W}$	0.22	K/W

6. Characteristics

Table 6. DC characteristics

$T_j = 25\text{ °C}$ per section, unless otherwise specified.

Symbol	Parameter	Conditions	Min	Typ	Max	Unit
$V_{(BR)DSS}$	drain-source breakdown voltage	$V_{GS} = 0\text{ V}; I_D = 1.44\text{ mA}$	65	-	-	V
$V_{GS(th)}$	gate-source threshold voltage	$V_{DS} = 10\text{ V}; I_D = 144\text{ mA}$	1.5	1.9	2.3	V
V_{GSq}	gate-source quiescent voltage	$V_{DS} = 28\text{ V}; I_D = 865\text{ mA}$	1.6	2	2.4	V
I_{DSS}	drain leakage current	$V_{GS} = 0\text{ V}; V_{DS} = 28\text{ V}$	-	-	2.8	μA
I_{DSX}	drain cut-off current	$V_{GS} = V_{GS(th)} + 3.75\text{ V}; V_{DS} = 10\text{ V}$	-	26.9	-	A
I_{GSS}	gate leakage current	$V_{GS} = 11\text{ V}; V_{DS} = 0\text{ V}$	-	-	280	nA
g_{fs}	forward transconductance	$V_{DS} = 10\text{ V}; I_D = 7.2\text{ A}$	-	11.2	-	S
$R_{DS(on)}$	drain-source on-state resistance	$V_{GS} = V_{GS(th)} + 3.75\text{ V}; I_D = 5.4\text{ A}$	-	0.10	-	Ω

Table 7. RF characteristics

Test signal: 2-carrier W-CDMA; 3GPP test model 1 with 64 DPCH; PAR = 8.4 dB at 0.01 % probability on the CCDF; $f_1 = 2602.5\text{ MHz}; f_2 = 2607.5\text{ MHz}; f_3 = 2692.5\text{ MHz}; f_4 = 2697.5\text{ MHz}$; RF performance at $V_{DS} = 28\text{ V}; I_{Dq} = 1730\text{ mA}; T_{case} = 25\text{ °C}$; unless otherwise specified; in a water cooled class-AB test circuit.

Symbol	Parameter	Conditions	Min	Typ	Max	Unit
G_p	power gain	$P_{L(AV)} = 65\text{ W}$	15.8	17	-	dB
η_D	drain efficiency	$P_{L(AV)} = 65\text{ W}$	27	30	-	%
RL_{in}	input return loss	$P_{L(AV)} = 65\text{ W}$	-	-13	-8	dB
$ACPR_{5M}$	adjacent channel power ratio (5 MHz)	$P_{L(AV)} = 65\text{ W}$	-	-29	-26	dBc

7. Test information

7.1 Ruggedness in class-AB operation

The BLC8G27LS-210PV is capable of withstanding a load mismatch corresponding to VSWR = 10 : 1 through all phases under the following conditions: $V_{DS} = 28\text{ V}; I_{Dq} = 1730\text{ mA}; P_L = 200\text{ W (CW)}; f = 2600\text{ MHz}$.

7.2 Impedance information

Table 8. Typical impedance

Measured load-pull data per section; $I_{Dq} = 865\text{ mA}; V_{DS} = 28\text{ V}$.

f (MHz)	Z_S [1] (Ω)	Z_L [1] (Ω)
2500	2.58 – j5.80	1.60 – j4.32
2600	3.40 – j6.30	1.65 – j4.44
2700	6.35 – j6.45	1.77 – j4.75

[1] Z_S and Z_L defined in [Figure 1](#).

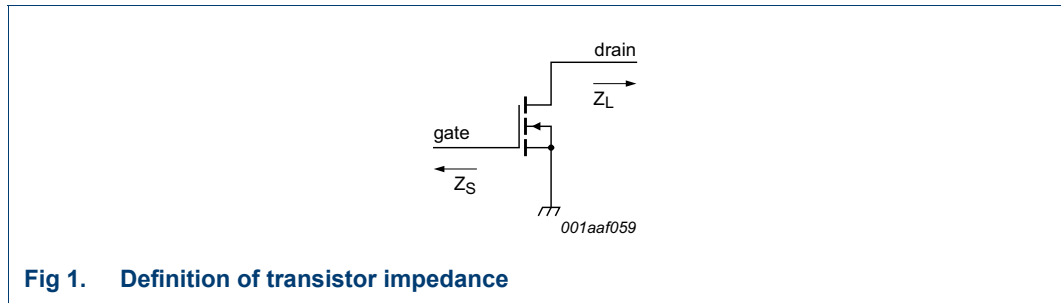

Fig 1. Definition of transistor impedance

7.3 VBW in a class-AB operation

The BLC8G27LS-210PV shows 150 MHz (typical) video bandwidth (IMD third-order intermodulation inflection point) in a class-AB test circuit in the 2.6 GHz to 2.7 GHz band at $V_{DS} = 28$ V and $I_{DQ} = 1.73$ A.

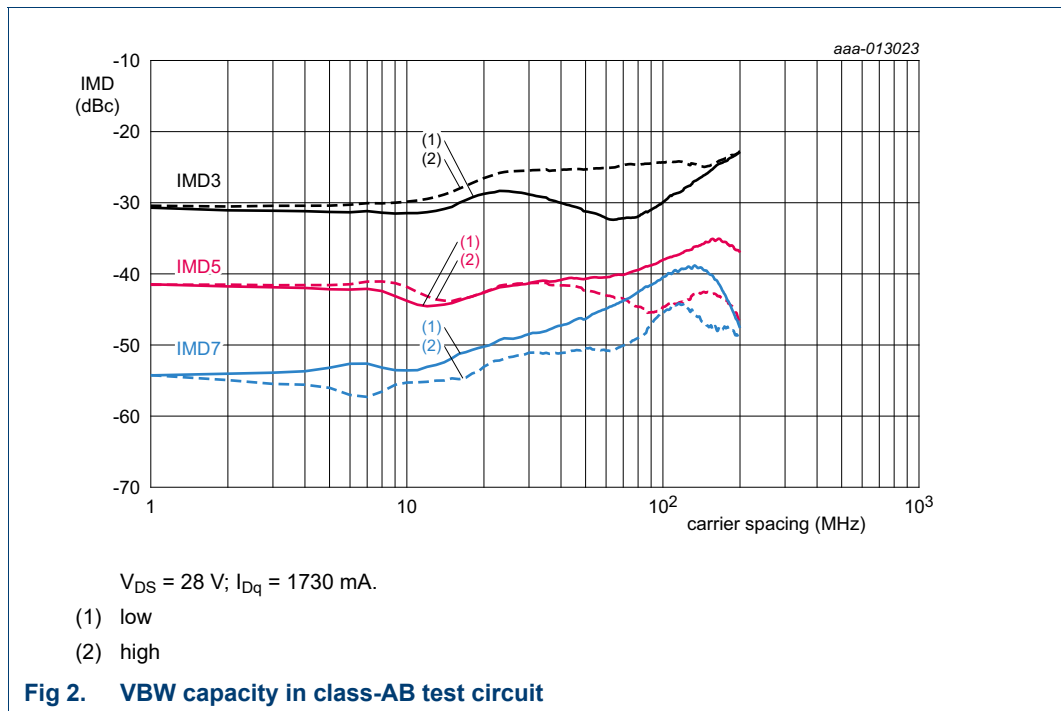

Fig 2. VBW capacity in class-AB test circuit

7.4 Test circuit

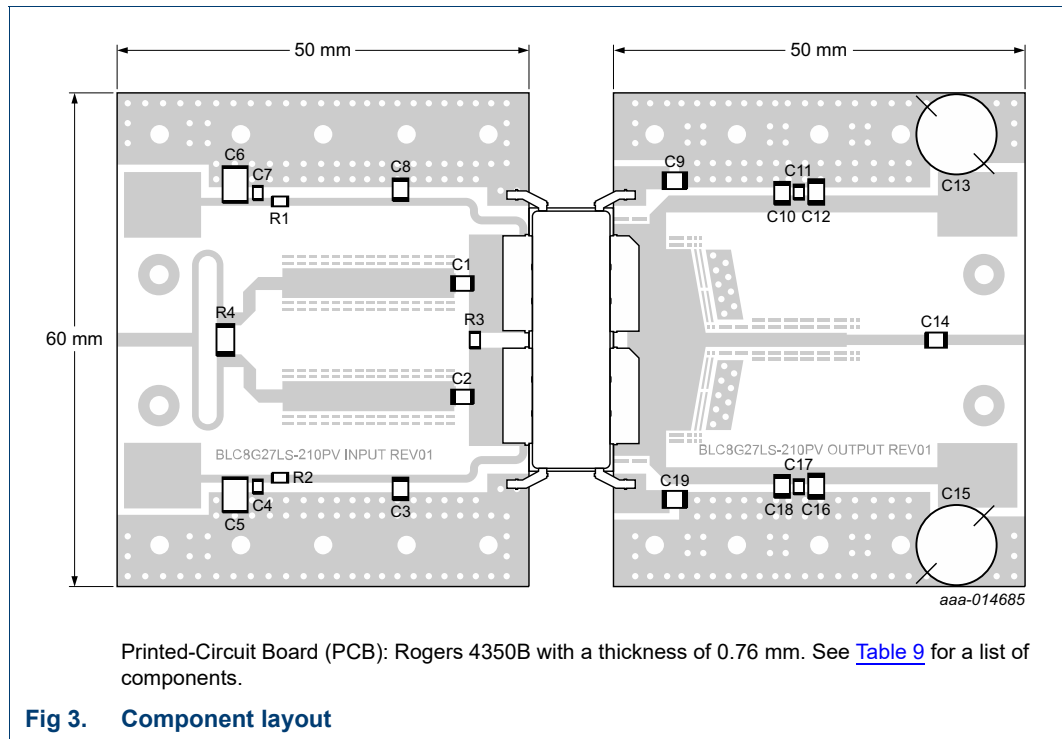

Table 9. List of components
See [Figure 3](#) for component layout.

Component	Description	Value	Remarks
C1, C2	multilayer ceramic chip capacitor	1.6 pF	[1] ATC 800B
C3, C8, C10, C14, C18	multilayer ceramic chip capacitor	24 pF	[1] ATC 800B
C4, C7	multilayer ceramic chip capacitor	100 nF	[2] Murata
C5, C6	multilayer ceramic chip capacitor	1 μF	[2] Murata
C9, C12, C16, C19	multilayer ceramic chip capacitor	470 μF, 50 V	[2] Murata
C11, C17	multilayer ceramic chip capacitor	220 nF	[2] Murata
C13, C15	electrolytic capacitor	> 470 μF, 63 V	
R1, R2	chip resistor	4.7 Ω, 1 % tolerance	SMD 0805
R3	chip resistor	10 Ω, 1 % tolerance	SMD 0805
R4	chip resistor	100 Ω, 1 % tolerance	SMD 2010

[1] American Technical Ceramics type 800B or capacitor of same quality.

[2] Murata or capacitor of same quality.

7.5 Graphical data

7.5.1 Pulsed CW

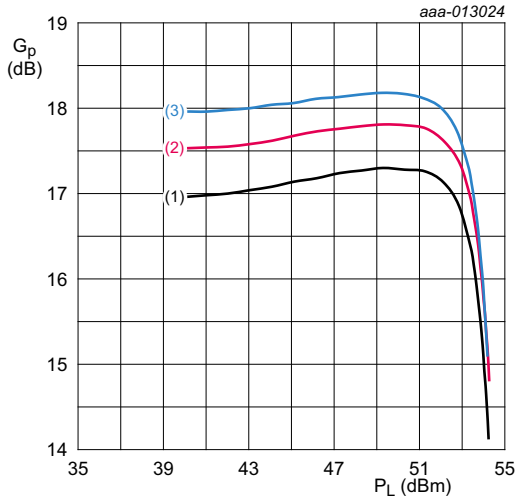

- $V_{DS} = 28\text{ V}; I_{Dq} = 1730\text{ mA}; t_p = 100\text{ }\mu\text{s}; \delta = 10\text{ }\%$.
- (1) $f = 2600\text{ MHz}$
 - (2) $f = 2650\text{ MHz}$
 - (3) $f = 2700\text{ MHz}$

Fig 4. Power gain as a function of output power; typical values

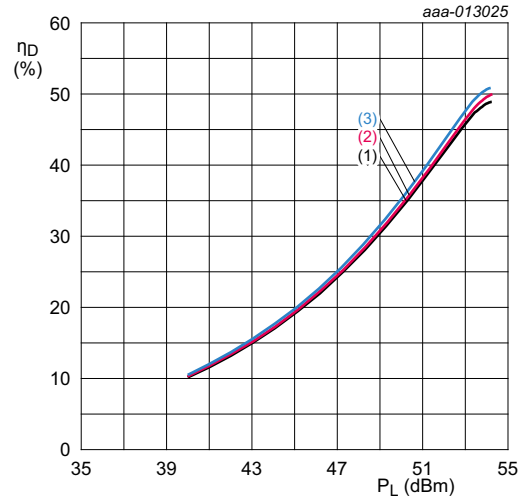

- $V_{DS} = 28\text{ V}; I_{Dq} = 1730\text{ mA}; t_p = 100\text{ }\mu\text{s}; \delta = 10\text{ }\%$.
- (1) $f = 2600\text{ MHz}$
 - (2) $f = 2650\text{ MHz}$
 - (3) $f = 2700\text{ MHz}$

Fig 5. Drain efficiency as a function of out power; typical values

7.5.2 IS-95

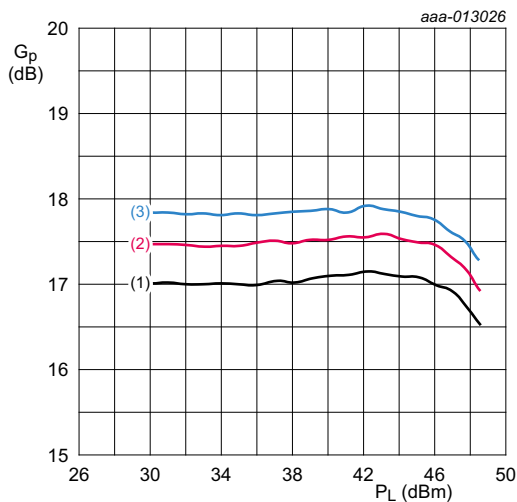

$V_{DS} = 28\text{ V}; I_{Dq} = 1730\text{ mA.}$
 (1) $f = 2605\text{ MHz}$
 (2) $f = 2650\text{ MHz}$
 (3) $f = 2695\text{ MHz}$

Fig 6. Power gain as a function of output power; typical values

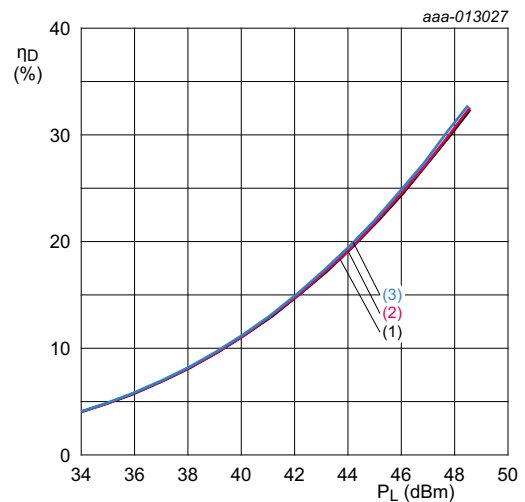

$V_{DS} = 28\text{ V}; I_{Dq} = 1730\text{ mA.}$
 (1) $f = 2605\text{ MHz}$
 (2) $f = 2650\text{ MHz}$
 (3) $f = 2695\text{ MHz}$

Fig 7. Drain efficiency as a function of output power; typical values

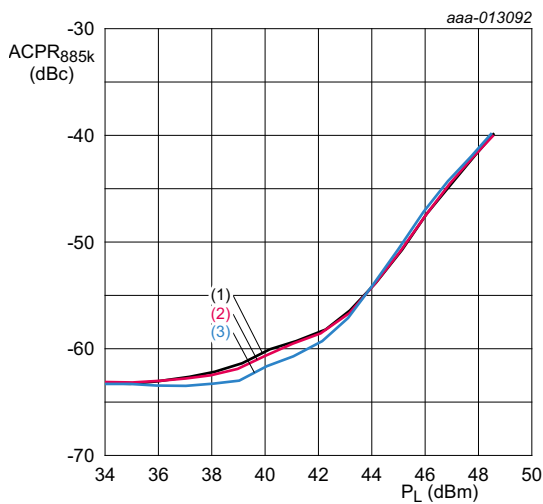

$V_{DS} = 28\text{ V}; I_{Dq} = 1730\text{ mA.}$
 (1) $f = 2605\text{ MHz}$
 (2) $f = 2650\text{ MHz}$
 (3) $f = 2695\text{ MHz}$

Fig 8. Adjacent channel power ratio (885 kHz) as a function of output power; typical values

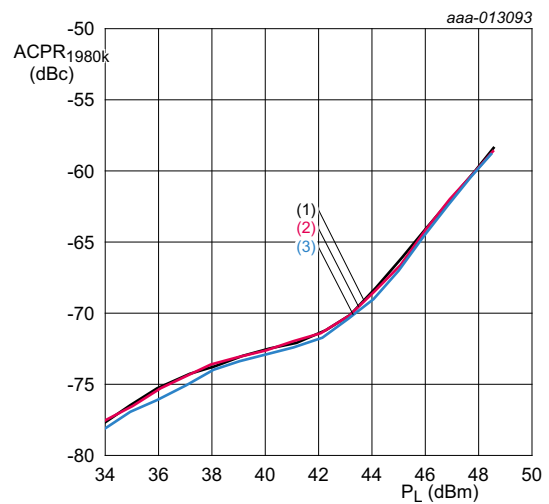

$V_{DS} = 28\text{ V}; I_{Dq} = 1730\text{ mA.}$
 (1) $f = 2605\text{ MHz}$
 (2) $f = 2650\text{ MHz}$
 (3) $f = 2695\text{ MHz}$

Fig 9. Adjacent channel power ratio (1980 kHz) as a function of output power; typical values

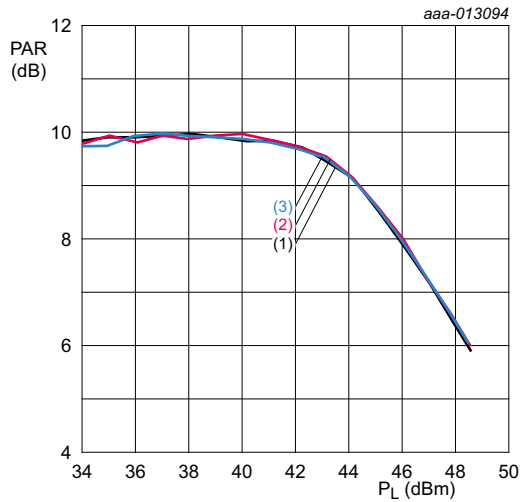

$V_{DS} = 28\text{ V}; I_{Dq} = 1730\text{ mA}$.
 (1) $f = 2605\text{ MHz}$
 (2) $f = 2650\text{ MHz}$
 (3) $f = 2695\text{ MHz}$

Fig 10. Peak-to-average ratio as a function of output power; typical values

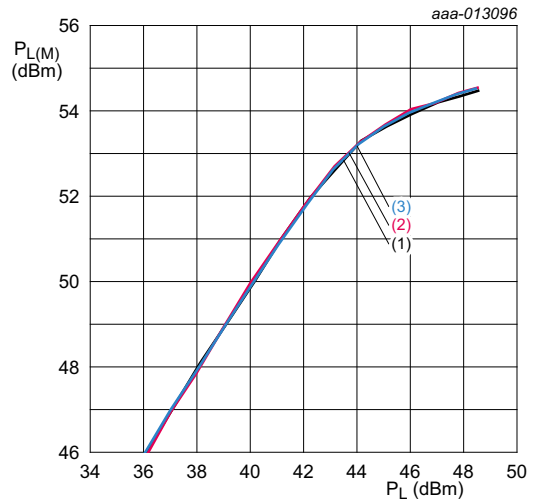

$V_{DS} = 28\text{ V}; I_{Dq} = 1730\text{ mA}$.
 (1) $f = 2605\text{ MHz}$
 (2) $f = 2650\text{ MHz}$
 (3) $f = 2695\text{ MHz}$

Fig 11. Peak output power as a function of output power; typical values

7.5.3 1-Carrier W-CDMA

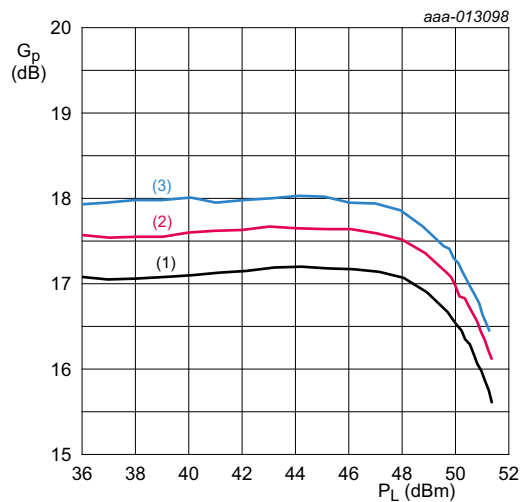

$V_{DS} = 28\text{ V}; I_{Dq} = 1730\text{ mA}$.
 (1) $f = 2602.5\text{ MHz}$
 (2) $f = 2650\text{ MHz}$
 (3) $f = 2697.5\text{ MHz}$

Fig 12. Power gain as a function of output power; typical values

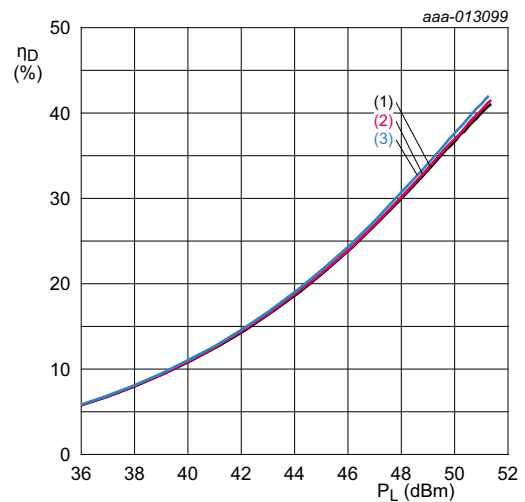

$V_{DS} = 28\text{ V}; I_{Dq} = 1730\text{ mA}$.
 (1) $f = 2602.5\text{ MHz}$
 (2) $f = 2650\text{ MHz}$
 (3) $f = 2697.5\text{ MHz}$

Fig 13. Drain efficiency as a function of output power; typical values

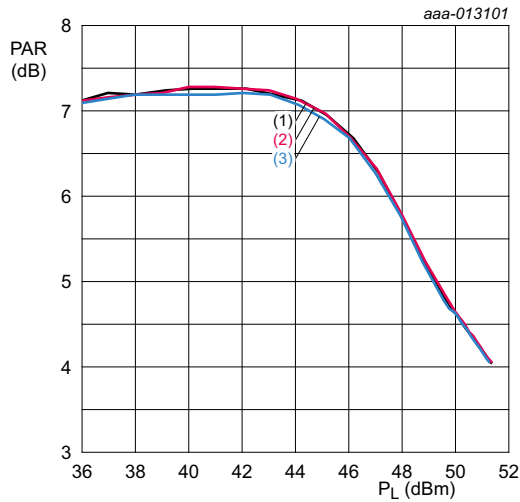

$V_{DS} = 28\text{ V}; I_{Dq} = 1730\text{ mA}.$
 (1) $f = 2602.5\text{ MHz}$
 (2) $f = 2650\text{ MHz}$
 (3) $f = 2697.5\text{ MHz}$

Fig 14. Peak-to-average ratio as a function of output power; typical values

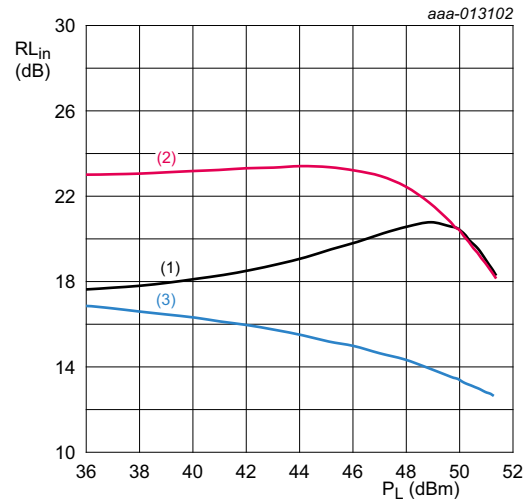

$V_{DS} = 28\text{ V}; I_{Dq} = 1730\text{ mA}.$
 (1) $f = 2602.5\text{ MHz}$
 (2) $f = 2650\text{ MHz}$
 (3) $f = 2697.5\text{ MHz}$

Fig 15. Input return loss as a function of output power; typical values

7.5.4 2-Carrier W-CDMA

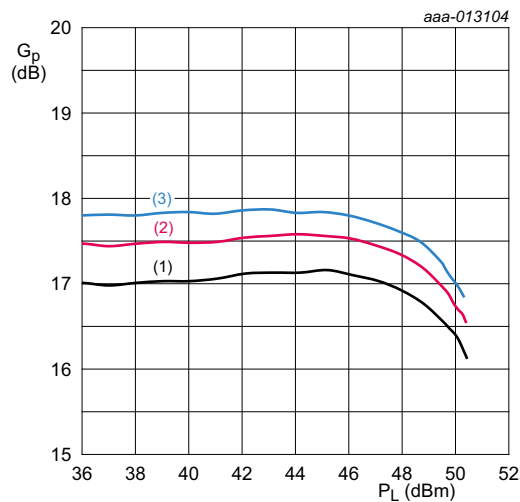

$V_{DS} = 28\text{ V}; I_{Dq} = 1730\text{ mA}.$
 (1) $f = 2605\text{ MHz}$
 (2) $f = 2650\text{ MHz}$
 (3) $f = 2695\text{ MHz}$

Fig 16. Power gain as a function of output power; typical values

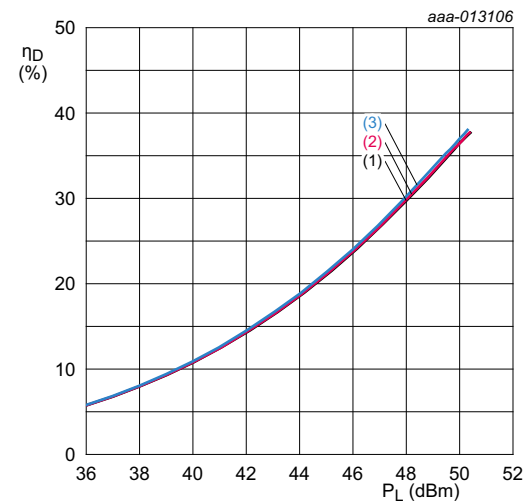

$V_{DS} = 28\text{ V}; I_{Dq} = 1730\text{ mA}.$
 (1) $f = 2605\text{ MHz}$
 (2) $f = 2650\text{ MHz}$
 (3) $f = 2695\text{ MHz}$

Fig 17. Drain efficiency as a function of output power; typical values

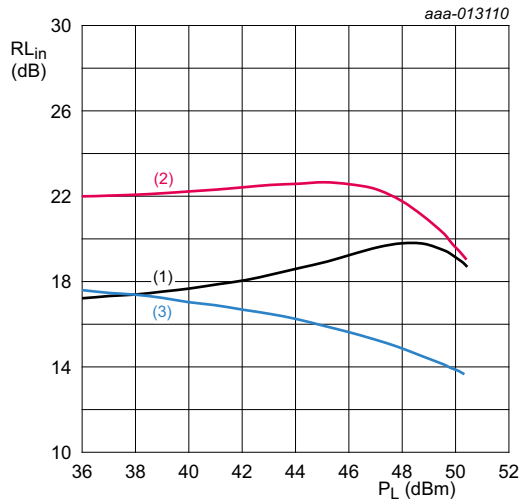

$V_{DS} = 28\text{ V}; I_{Dq} = 1730\text{ mA}$.
 (1) $f = 2605\text{ MHz}$
 (2) $f = 2650\text{ MHz}$
 (3) $f = 2695\text{ MHz}$

Fig 18. Input return loss as a function of output power; typical values

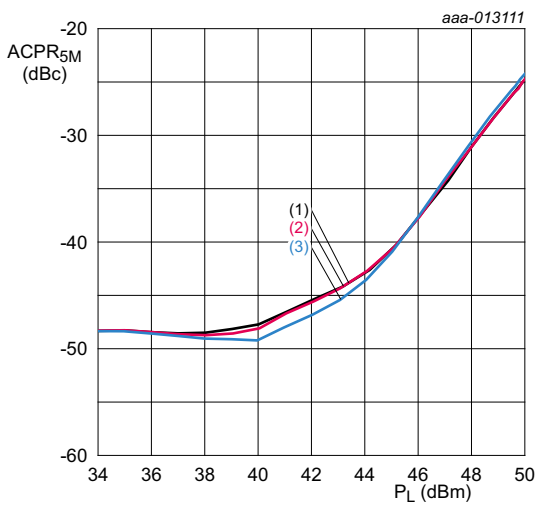

$V_{DS} = 28\text{ V}; I_{Dq} = 1730\text{ mA}$.
 (1) $f = 2605\text{ MHz}$
 (2) $f = 2650\text{ MHz}$
 (3) $f = 2695\text{ MHz}$

Fig 19. Adjacent channel power ratio (5 MHz) as a function of output power; typical values

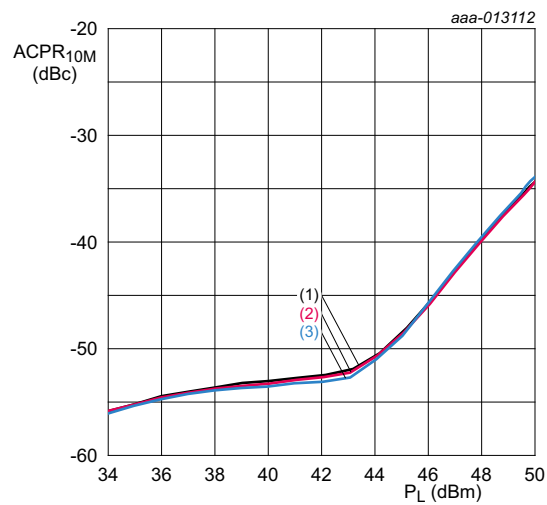

$V_{DS} = 28\text{ V}; I_{Dq} = 1730\text{ mA}$.
 (1) $f = 2605\text{ MHz}$
 (2) $f = 2650\text{ MHz}$
 (3) $f = 2695\text{ MHz}$

Fig 20. Adjacent channel power ratio (10 MHz) as a function of output power; typical values

8. Package outline

Air cavity plastic earless flanged package; 8 leads

SOT1251-1

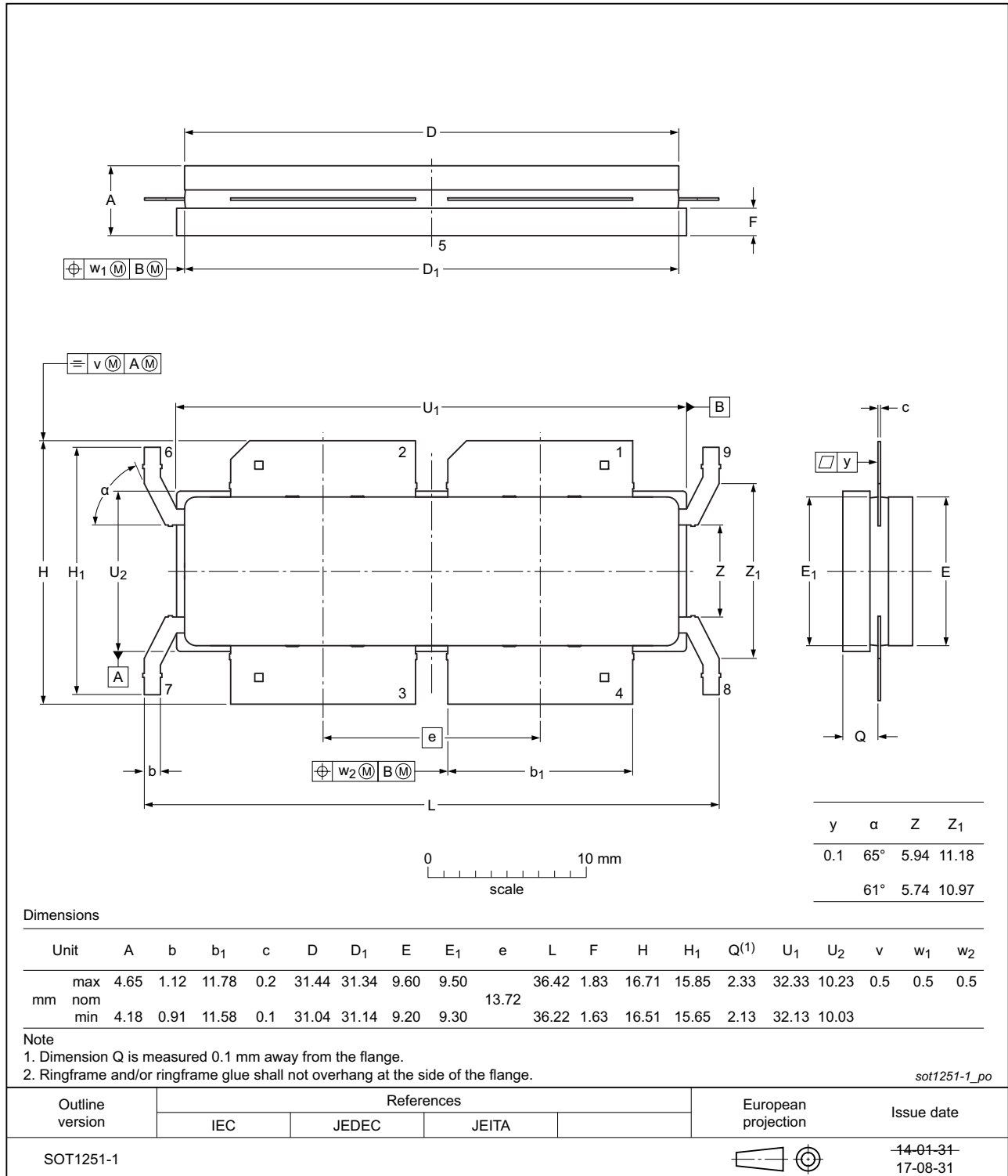

Fig 21. Package outline SOT1251-1

9. Handling information

CAUTION	
	<p>This device is sensitive to ElectroStatic Discharge (ESD). Observe precautions for handling electrostatic sensitive devices.</p> <p>Such precautions are described in the <i>ANSI/ESD S20.20</i>, <i>IEC/ST 61340-5</i>, <i>JESD625-A</i> or equivalent standards.</p>

Table 10. ESD sensitivity

ESD model	Class
Charged Device Model (CDM); According to ANSI/ESDA/JEDEC standard JS-002	C2A [1]
Human Body Model (HBM); According to ANSI/ESDA/JEDEC standard JS-001	3A [2]

- [1] CDM classification C2A is granted to any part that passes after exposure to an ESD pulse of 500 V, but fails after exposure to an ESD pulse of 750 V.
- [2] HBM classification 3A is granted to any part that passes after exposure to an ESD pulse of 4000 V, but fails after exposure to an ESD pulse of 8000 V.

10. Abbreviations

Table 11. Abbreviations

Acronym	Description
3GPP	3rd Generation Partnership Project
CCDF	Complementary Cumulative Distribution Function
CW	Continuous Wave
DPCH	Dedicated Physical CHannel
ESD	ElectroStatic Discharge
IS-95	Interim Standard 95
LDMOS	Laterally Diffused Metal Oxide Semiconductor
MTF	Median Time to Failure
PAR	Peak-to-Average Ratio
SMD	Surface Mounted Device
VBW	Video BandWidth
VSWR	Voltage Standing Wave Ratio
W-CDMA	Wideband Code Division Multiple Access

11. Revision history

Table 12. Revision history

Document ID	Release date	Data sheet status	Change notice	Supersedes
BLC8G27LS-210PV v.4	20171124	Product data sheet	-	BLC8G27LS-210PV v.3
Modifications:	<ul style="list-style-type: none"> • Table 2 on page 2: changed simplified version drawing SOT1251-3 to SOT1251-1 • Table 3 on page 2: changed version SOT1251-3 to SOT1251-1 • Figure 21 on page 11: changed package outline drawing SOT1251-3 to SOT1251-1 			
BLC8G27LS-210PV v.3	20161202	Product data sheet	-	BLC8G27LS-210PV v.2
BLC8G27LS-210PV v.2	20150901	Product data sheet	-	BLC8G27LS-210PV v.1
BLC8G27LS-210PV v.1	20150209	Product data sheet	-	-

12. Legal information

12.1 Data sheet status

Document status ^{[1][2]}	Product status ^[3]	Definition
Objective [short] data sheet	Development	This document contains data from the objective specification for product development.
Preliminary [short] data sheet	Qualification	This document contains data from the preliminary specification.
Product [short] data sheet	Production	This document contains the product specification.

[1] Please consult the most recently issued document before initiating or completing a design.

[2] The term 'short data sheet' is explained in section "Definitions".

[3] The product status of device(s) described in this document may have changed since this document was published and may differ in case of multiple devices. The latest product status information is available on the Internet at URL <http://www.ampleon.com>.

12.2 Definitions

Draft — The document is a draft version only. The content is still under internal review and subject to formal approval, which may result in modifications or additions. Ampleon does not give any representations or warranties as to the accuracy or completeness of information included herein and shall have no liability for the consequences of use of such information.

Short data sheet — A short data sheet is an extract from a full data sheet with the same product type number(s) and title. A short data sheet is intended for quick reference only and should not be relied upon to contain detailed and full information. For detailed and full information see the relevant full data sheet, which is available on request via the local Ampleon sales office. In case of any inconsistency or conflict with the short data sheet, the full data sheet shall prevail.

Product specification — The information and data provided in a Product data sheet shall define the specification of the product as agreed between Ampleon and its customer, unless Ampleon and customer have explicitly agreed otherwise in writing. In no event however, shall an agreement be valid in which the Ampleon product is deemed to offer functions and qualities beyond those described in the Product data sheet.

Ampleon product can reasonably be expected to result in personal injury, death or severe property or environmental damage. Ampleon and its suppliers accept no liability for inclusion and/or use of Ampleon products in such equipment or applications and therefore such inclusion and/or use is at the customer's own risk.

Applications — Applications that are described herein for any of these products are for illustrative purposes only. Ampleon makes no representation or warranty that such applications will be suitable for the specified use without further testing or modification.

Customers are responsible for the design and operation of their applications and products using Ampleon products, and Ampleon accepts no liability for any assistance with applications or customer product design. It is customer's sole responsibility to determine whether the Ampleon product is suitable and fit for the customer's applications and products planned, as well as for the planned application and use of customer's third party customer(s). Customers should provide appropriate design and operating safeguards to minimize the risks associated with their applications and products.

Ampleon does not accept any liability related to any default, damage, costs or problem which is based on any weakness or default in the customer's applications or products, or the application or use by customer's third party customer(s). Customer is responsible for doing all necessary testing for the customer's applications and products using Ampleon products in order to avoid a default of the applications and the products or of the application or use by customer's third party customer(s). Ampleon does not accept any liability in this respect.

Limiting values — Stress above one or more limiting values (as defined in the Absolute Maximum Ratings System of IEC 60134) will cause permanent damage to the device. Limiting values are stress ratings only and (proper) operation of the device at these or any other conditions above those given in the Recommended operating conditions section (if present) or the Characteristics sections of this document is not warranted. Constant or repeated exposure to limiting values will permanently and irreversibly affect the quality and reliability of the device.

Terms and conditions of commercial sale — Ampleon products are sold subject to the general terms and conditions of commercial sale, as published at <http://www.ampleon.com/terms>, unless otherwise agreed in a valid written individual agreement. In case an individual agreement is concluded only the terms and conditions of the respective agreement shall apply. Ampleon hereby expressly objects to applying the customer's general terms and conditions with regard to the purchase of Ampleon products by customer.

No offer to sell or license — Nothing in this document may be interpreted or construed as an offer to sell products that is open for acceptance or the grant, conveyance or implication of any license under any copyrights, patents or other industrial or intellectual property rights.

Export control — This document as well as the item(s) described herein may be subject to export control regulations. Export might require a prior authorization from competent authorities.

12.3 Disclaimers

Limited warranty and liability — Information in this document is believed to be accurate and reliable. However, Ampleon does not give any representations or warranties, expressed or implied, as to the accuracy or completeness of such information and shall have no liability for the consequences of use of such information. Ampleon takes no responsibility for the content in this document if provided by an information source outside of Ampleon.

In no event shall Ampleon be liable for any indirect, incidental, punitive, special or consequential damages (including - without limitation - lost profits, lost savings, business interruption, costs related to the removal or replacement of any products or rework charges) whether or not such damages are based on tort (including negligence), warranty, breach of contract or any other legal theory.

Notwithstanding any damages that customer might incur for any reason whatsoever, Ampleon's aggregate and cumulative liability towards customer for the products described herein shall be limited in accordance with the *Terms and conditions of commercial sale* of Ampleon.

Right to make changes — Ampleon reserves the right to make changes to information published in this document, including without limitation specifications and product descriptions, at any time and without notice. This document supersedes and replaces all information supplied prior to the publication hereof.

Suitability for use — Ampleon products are not designed, authorized or warranted to be suitable for use in life support, life-critical or safety-critical systems or equipment, nor in applications where failure or malfunction of an

Non-automotive qualified products — Unless this data sheet expressly states that this specific Ampleon product is automotive qualified, the product is not suitable for automotive use. It is neither qualified nor tested in accordance with automotive testing or application requirements. Ampleon accepts no liability for inclusion and/or use of non-automotive qualified products in automotive equipment or applications.

In the event that customer uses the product for design-in and use in automotive applications to automotive specifications and standards, customer (a) shall use the product without Ampleon's warranty of the product for such automotive applications, use and specifications, and (b) whenever customer uses the product for automotive applications beyond Ampleon's specifications such use shall be solely at customer's own risk, and (c) customer fully indemnifies Ampleon for any liability, damages or failed product claims resulting from customer design and use of the product for automotive applications beyond Ampleon's standard warranty and Ampleon's product specifications.

Translations — A non-English (translated) version of a document is for reference only. The English version shall prevail in case of any discrepancy between the translated and English versions.

12.4 Trademarks

Notice: All referenced brands, product names, service names and trademarks are the property of their respective owners.

Any reference or use of any 'NXP' trademark in this document or in or on the surface of Ampleon products does not result in any claim, liability or entitlement vis-à-vis the owner of this trademark. Ampleon is no longer part of the NXP group of companies and any reference to or use of the 'NXP' trademarks will be replaced by reference to or use of Ampleon's own trademarks.

13. Contact information

For more information, please visit: <http://www.ampleon.com>

For sales office addresses, please visit: <http://www.ampleon.com/sales>

14. Contents

1 **Product profile** 1

1.1 General description 1

1.2 Features and benefits 1

1.3 Applications 1

2 **Pinning information** 2

3 **Ordering information** 2

4 **Limiting values** 2

5 **Thermal characteristics** 2

6 **Characteristics** 3

7 **Test information** 3

7.1 Ruggedness in class-AB operation 3

7.2 Impedance information 3

7.3 VBW in a class-AB operation 4

7.4 Test circuit 5

7.5 Graphical data 6

7.5.1 Pulsed CW 6

7.5.2 IS-95 7

7.5.3 1-Carrier W-CDMA 8

7.5.4 2-Carrier W-CDMA 9

8 **Package outline** 11

9 **Handling information** 12

10 **Abbreviations** 12

11 **Revision history** 13

12 **Legal information** 14

12.1 Data sheet status 14

12.2 Definitions 14

12.3 Disclaimers 14

12.4 Trademarks 15

13 **Contact information** 15

14 **Contents** 16

Please be aware that important notices concerning this document and the product(s) described herein, have been included in section 'Legal information'.

© Ampleon Netherlands B.V. 2017. All rights reserved.

For more information, please visit: <http://www.ampleon.com>
 For sales office addresses, please visit: <http://www.ampleon.com/sales>

Date of release: 24 November 2017
 Document identifier: BLC8G27LS-210PV

Looking for pricing, stock, or lifecycle information?

Click below to explore more details on WIN SOURCE:

- ⊖ [View BLC8G27LS-210PVY on WIN SOURCE](#)
- ⊖ [Ampleon USA Inc. Information](#)

Optimize Your Supply Chain with WIN SOURCE Solutions

- ✓ Global Sourcing Solution
- ✓ Obsolete Management
- ✓ Cost Control Management
- ✓ Shortage Management
- ✓ Alternative Solution
- ✓ Excess Inventory Management