



**THE DATASHEET OF
BLD6G22LS-50,112**



BLD6G22L-50; BLD6G22LS-50

W-CDMA 2110 MHz to 2170 MHz fully integrated Doherty transistor

AMPLEON
Product data sheet

Rev. 4 — 1 September 2015

1. Product profile

1.1 General description

The BLD6G22L-50 and BLD22LS-50 incorporate a fully integrated Doherty solution using Ampleon's state of the art GEN6 LDMOS technology. This device is perfectly suited for CDMA base station applications at frequencies from 2110 MHz to 2170 MHz. The main and peak device, input splitter and output combiner are integrated in a single package. This package consists of one gate and drain lead and two extra leads of which one is used for biasing the peak amplifier and the other is not connected. It only requires the proper input/output match and bias setting as with a normal class-AB transistor.

Table 1. Typical performance

RF performance at $T_h = 25$ °C.

Mode of operation	f (MHz)	V_{DS} (V)	$P_{L(AV)}$ (W)	G_p (dB)	η_D (%)	ACPR (dBc)	$P_{L(3dB)}$ (W)
W-CDMA [1][2]	2110 to 2170	28	8	14	40	-30	55

[1] Test signal: 2-carrier W-CDMA; test model 1; 64 DPCH; PAR = 8.3 dB at 0.01 % probability on CCDF; carrier spacing 5 MHz.

[2] $I_{DQ} = 170$ mA (main); $V_{GS(amp)peak} = 0$ V.

CAUTION



This device is sensitive to ElectroStatic Discharge (ESD). Therefore care should be taken during transport and handling.

1.2 Features and benefits

- Typical W-CDMA performance at frequencies from 2110 MHz to 2170 MHz:
 - ◆ Average output power = 8 W
 - ◆ Power gain = 14 dB
 - ◆ Efficiency = 40 %
- Fully optimized integrated Doherty concept:
 - ◆ integrated asymmetrical power splitter at input
 - ◆ integrated power combiner
 - ◆ peak biasing down to 0 V
 - ◆ low junction temperature
 - ◆ high efficiency

- 100 % peak power tested for guaranteed output power capability
- Integrated ESD protection
- Good pair match (main and peak on the same chip)
- Independent control of main and peak bias
- Internally matched for ease of use
- Excellent ruggedness
- Compliant to Directive 2002/95/EC, regarding Restriction of Hazardous Substances (RoHS)

1.3 Applications

- High efficiency RF power amplifiers with digital pre-distortion for W-CDMA multi carrier applications in the 2110 MHz to 2170 MHz range.

2. Pinning information

Table 2. Pinning

Pin	Description	Simplified outline	Graphic symbol
BLD6G22L-50 (SOT1130A)			
1	drain		
2	gate + bias main		
3	source [1]		
4	n.c.		
5	bias peak		
BLD6G22LS-50 (SOT1130B)			
1	drain		
2	gate + bias main		
3	source [1]		
4	n.c.		
5	bias peak		

[1] Connected to flange.

3. Ordering information

Table 3. Ordering information

Type number	Package		
	Name	Description	Version
BLD6G22L-50	-	flanged ceramic package; 2 mounting holes; 4 leads	SOT1130A
BLD6G22LS-50	-	earless flanged ceramic package; 4 leads	SOT1130B

4. Block diagram

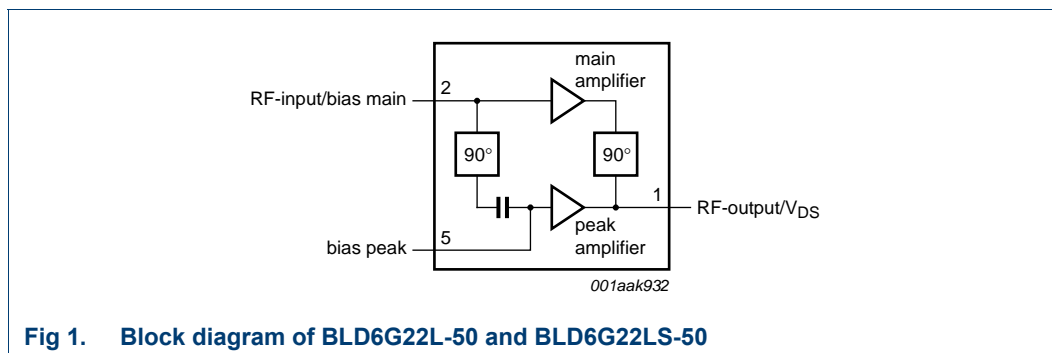

Fig 1. Block diagram of BLD6G22L-50 and BLD6G22LS-50

5. Limiting values

Table 4. Limiting values

In accordance with the Absolute Maximum Rating System (IEC 60134).
Valid for both main and peak device.

Symbol	Parameter	Conditions	Min	Max	Unit
V _{DS}	drain-source voltage		-	65	V
V _{GS(amp)main}	main amplifier gate-source voltage		-0.5	+13	V
V _{GS(amp)peak}	peak amplifier gate-source voltage		-0.5	+13	V
I _D	drain current		-	10.2	A
T _{stg}	storage temperature		-65	+150	°C
T _j	junction temperature		-	200	°C

6. Thermal characteristics

Table 5. Thermal characteristics

Symbol	Parameter	Conditions	Typ	Unit
R _{th(j-case)}	thermal resistance from junction to case	T _{case} = 80 °C; P _L = 8 W	[1] 1.9	K/W

[1] When operated with a 2-carrier (W-CDMA) modulated signal with PAR = 8.3 dB at 0.01 % probability on the CCDF.

7. Characteristics

Table 6. Characteristics

Valid for both main and peak device.

Symbol	Parameter	Conditions	Min	Typ	Max	Unit
V _{(BR)DSS}	drain-source breakdown voltage	V _{GS} = 0 V; I _D = 0.62 mA	65	-	-	V
V _{GS(th)}	gate-source threshold voltage	V _{DS} = 10 V; I _D = 31 mA	1.4	1.8	2.4	V
V _{GSq}	gate-source quiescent voltage	V _{DS} = 28 V; I _D = 170 mA	1.55	2.05	2.55	V
I _{DSS}	drain leakage current	V _{GS} = 0 V; V _{DS} = 28 V	-	-	1.4	μA
I _{DSX}	drain cut-off current	V _{GS} = V _{GS(th)} + 3.75 V; V _{DS} = 10 V	4.95	5.5	-	A

Table 6. Characteristics ...continued
Valid for both main and peak device.

Symbol	Parameter	Conditions	Min	Typ	Max	Unit
I_{GSS}	gate leakage current	$V_{GS} = 11\text{ V}; V_{DS} = 0\text{ V}$	-	-	140	nA
g_{fs}	forward transconductance	$V_{DS} = 10\text{ V}; I_D = 1.55\text{ A}$	1.4	2.2	-	S
$R_{DS(on)}$	drain-source on-state resistance	$V_{GS} = V_{GS(th)} + 3.75\text{ V}; I_D = 1.085\text{ A}$	-	0.52	0.736	Ω

8. Application information

Table 7. Application information

Mode of operation: 2-carrier W-CDMA; PAR 8.3 dB at 0.01 % probability on CCDF; carrier spacing = 5 MHz; $f = 2140\text{ MHz}$; RF performance at $V_{DS} = 28\text{ V}; I_{Dq} = 170\text{ mA}; V_{GS(amp)peak} = 0\text{ V}; T_{case} = 25\text{ }^\circ\text{C}$; unless otherwise specified; in a production circuit.

Symbol	Parameter	Conditions	Min	Typ	Max	Unit
$P_{L(AV)}$	average output power		-	8	-	W
G_p	power gain	$P_{L(AV)} = 8\text{ W}$	12.5	14	-	dB
η_D	drain efficiency	$P_{L(AV)} = 8\text{ W}$	37	40	-	%
PAR_O	output peak-to-average ratio	$P_{L(AV)} = 8\text{ W}$	-	7.6	-	dB
RL_{in}	input return loss	$P_{L(AV)} = 8\text{ W}$	10	17	-	dB
ACPR	adjacent channel power ratio	$P_{L(AV)} = 8\text{ W}$	-	-30	-24	dBc

Table 8. Application information

Mode of operation: Pulsed CW; $\delta = 10\text{ }%$; $t_p = 100\text{ }\mu\text{s}$; RF performance at $V_{DS} = 28\text{ V}; I_{Dq} = 170\text{ mA}; V_{GS(amp)peak} = 0\text{ V}; T_{case} = 25\text{ }^\circ\text{C}$; unless otherwise specified; in a production circuit.

Symbol	Parameter	Conditions	Min	Typ	Max	Unit
$P_{L(3dB)}$	output power at 3 dB gain compression		46	55	-	W

8.1 Ruggedness in Doherty operation

The BLD6G22L-50 and BLD6G22LS-50 are capable of withstanding a load mismatch corresponding to VSWR = 10 : 1 through all phases under the following conditions: $V_{DS} = 28\text{ V}; I_{Dq} = 170\text{ mA}; P_L = 8\text{ W}$ (W-CDMA); $f = 2140\text{ MHz}$.

8.2 Impedance information

Table 9. Typical impedance

Measured load-pull data; typical values unless otherwise specified.

f MHz	Z_S Ω	Z_L Ω
2050	9.4 – 12.3j	5.5 – 7.6j
2110	11.4 – 11.2j	6.7 – 8.2j
2140	12.3 – 10.5j	7.0 – 7.5j
2170	12.2 – 9.3j	7.2 – 6.8j
2230	11.8 – 7.3j	5.4 – 5.5j

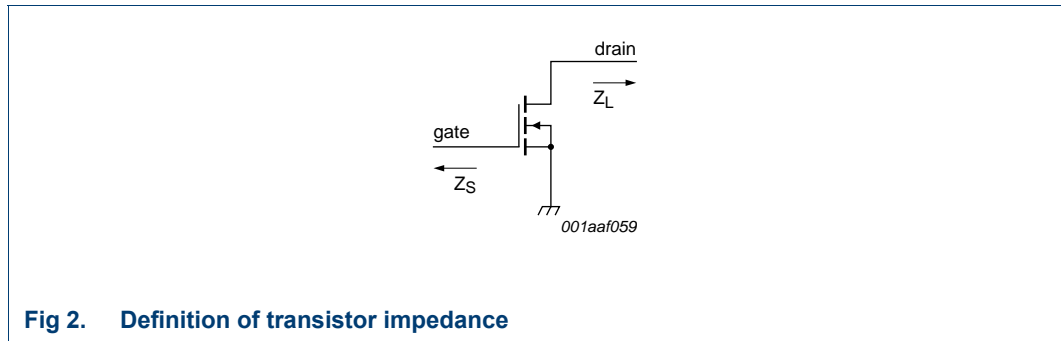
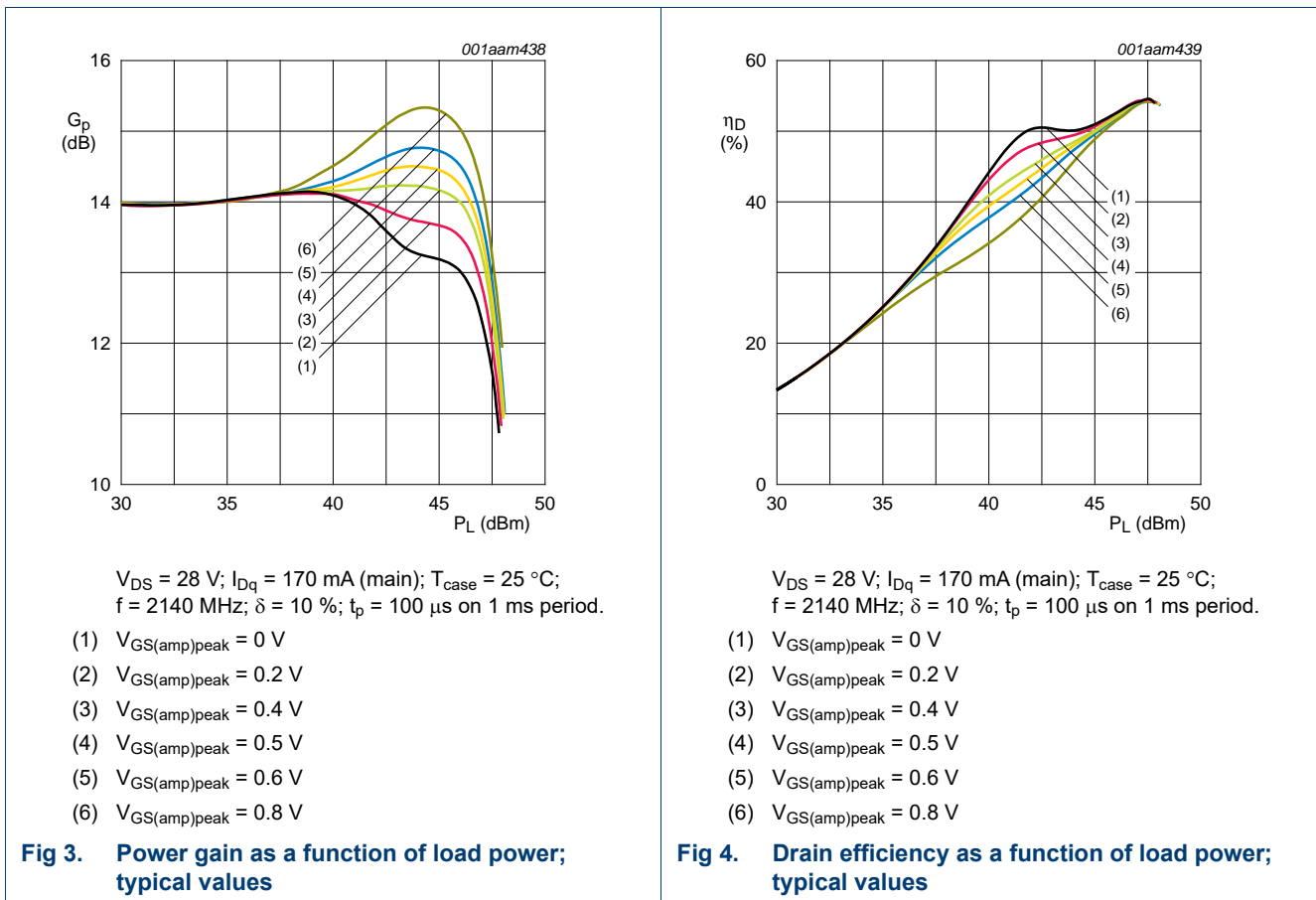

Fig 2. Definition of transistor impedance

8.3 Performance curves

Performance curves are measured in a BLD6G22L-50 application circuit.

8.3.1 CW pulsed



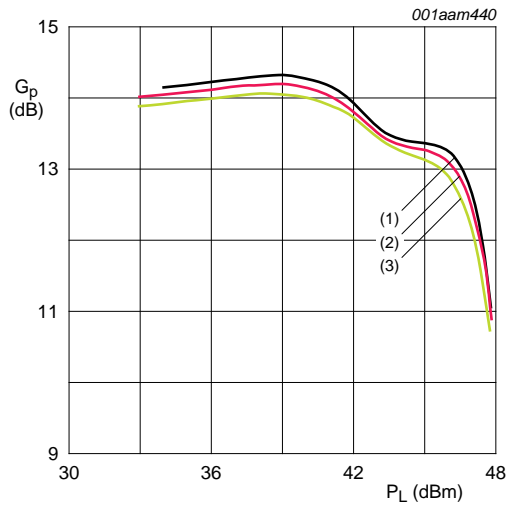

$V_{DS} = 28\text{ V}$; $I_{Dq} = 170\text{ mA (main)}$; $T_{case} = 25\text{ }^\circ\text{C}$;
 $V_{GS(amp)peak} = 0\text{ V}$; $\delta = 10\%$; $t_p = 100\text{ }\mu\text{s}$ on 1 ms period.

- (1) $f = 2110\text{ MHz}$
- (2) $f = 2140\text{ MHz}$
- (3) $f = 2170\text{ MHz}$

Fig 5. Power gain as a function of load power; typical values

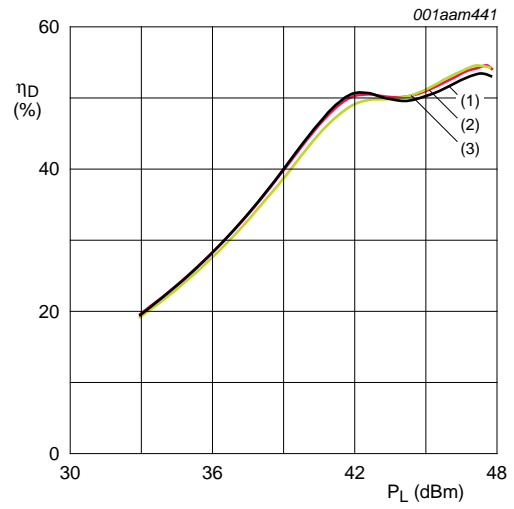

$V_{DS} = 28\text{ V}$; $I_{Dq} = 170\text{ mA (main)}$; $T_{case} = 25\text{ }^\circ\text{C}$;
 $V_{GS(amp)peak} = 0\text{ V}$; $\delta = 10\%$; $t_p = 100\text{ }\mu\text{s}$ on 1 ms period.

- (1) $f = 2110\text{ MHz}$
- (2) $f = 2140\text{ MHz}$
- (3) $f = 2170\text{ MHz}$

Fig 6. Drain efficiency as a function of load power; typical values

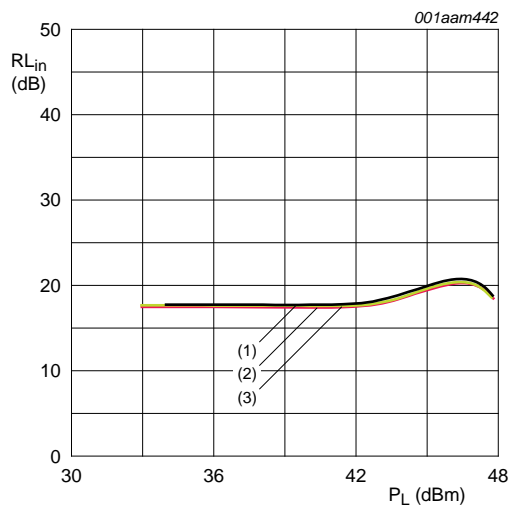

$V_{DS} = 28\text{ V}$; $I_{Dq} = 170\text{ mA (main)}$; $T_{case} = 25\text{ }^\circ\text{C}$; $V_{GS(amp)peak} = 0\text{ V}$; $\delta = 10\%$; $t_p = 100\text{ }\mu\text{s}$ on 1 ms period.

- (1) $f = 2110\text{ MHz}$
- (2) $f = 2140\text{ MHz}$
- (3) $f = 2170\text{ MHz}$

Fig 7. Input return loss as a function of load power; typical values

8.3.2 W-CDMA

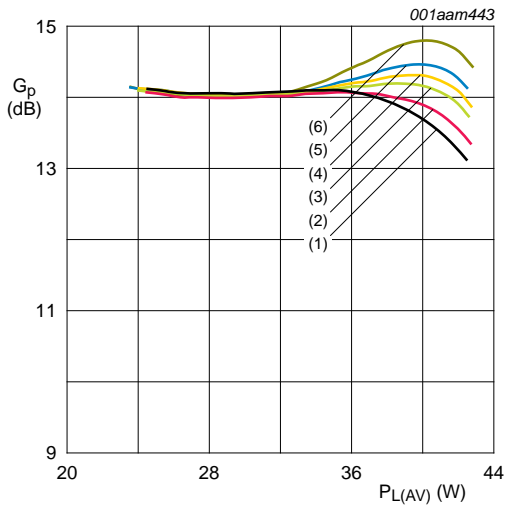

$V_{DS} = 28\text{ V}$; $I_{Dq} = 170\text{ mA}$ (main); $T_{case} = 25\text{ }^\circ\text{C}$;
 $f = 2140\text{ MHz}$; 2-carrier W-CDMA; PAR = 8.3 dB at 0.01 % probability on CCDF.

- (1) $V_{GS(amp)peak} = 0\text{ V}$
- (2) $V_{GS(amp)peak} = 0.2\text{ V}$
- (3) $V_{GS(amp)peak} = 0.4\text{ V}$
- (4) $V_{GS(amp)peak} = 0.5\text{ V}$
- (5) $V_{GS(amp)peak} = 0.6\text{ V}$
- (6) $V_{GS(amp)peak} = 0.8\text{ V}$

Fig 8. Power gain as a function of average load power; typical values

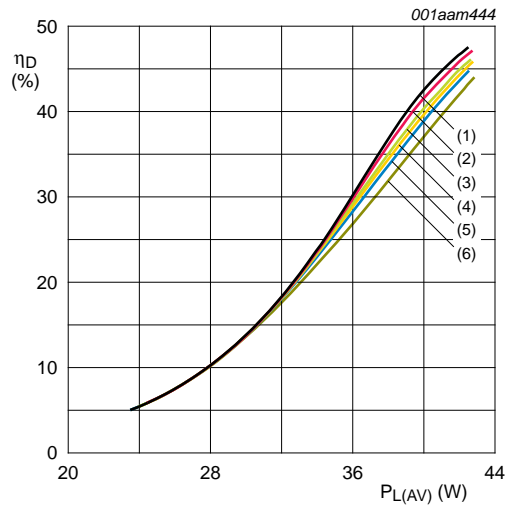

$V_{DS} = 28\text{ V}$; $I_{Dq} = 170\text{ mA}$ (main); $T_{case} = 25\text{ }^\circ\text{C}$;
 $f = 2140\text{ MHz}$; 2-carrier W-CDMA; PAR = 8.3 dB at 0.01 % probability on CCDF.

- (1) $V_{GS(amp)peak} = 0\text{ V}$
- (2) $V_{GS(amp)peak} = 0.2\text{ V}$
- (3) $V_{GS(amp)peak} = 0.4\text{ V}$
- (4) $V_{GS(amp)peak} = 0.5\text{ V}$
- (5) $V_{GS(amp)peak} = 0.6\text{ V}$
- (6) $V_{GS(amp)peak} = 0.8\text{ V}$

Fig 9. Drain efficiency as a function of average load power; typical values

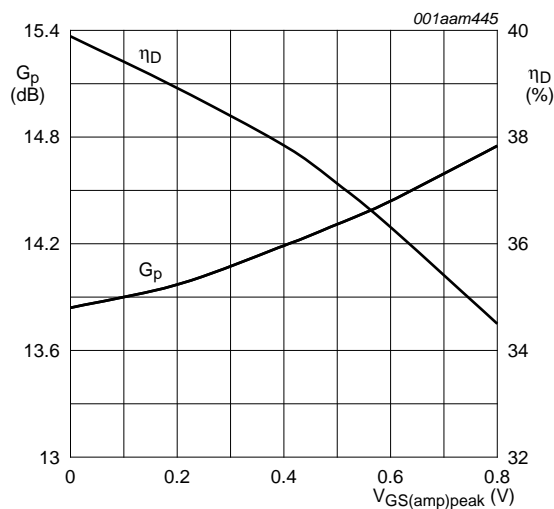

$V_{DS} = 28\text{ V}$; $I_{Dq} = 170\text{ mA}$ (main); $T_{case} = 25\text{ }^\circ\text{C}$; $f = 2140\text{ MHz}$; 2-carrier W-CDMA; PAR = 8.3 dB at 0.01 % probability on CCDF.

Fig 10. Power gain and drain efficiency as function of load power; typical values

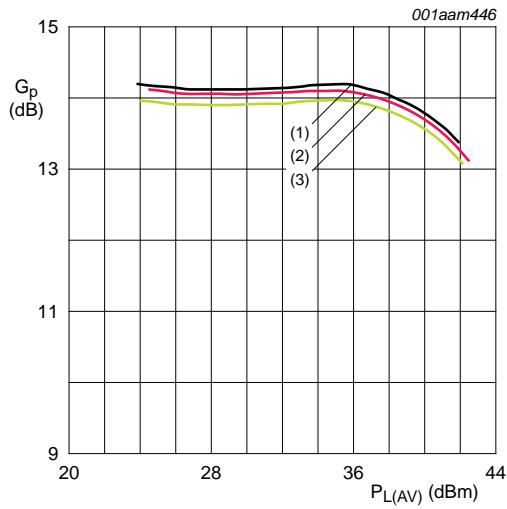

$V_{DS} = 28\text{ V}$; $I_{Dq} = 170\text{ mA}$ (main); $T_{case} = 25\text{ }^\circ\text{C}$;
 $V_{GS(amp)peak} = 0\text{ V}$; 2-carrier W-CDMA; PAR = 8.3 dB at 0.01 % probability on CCDF.

- (1) $f = 2110\text{ MHz}$
- (2) $f = 2140\text{ MHz}$
- (3) $f = 2170\text{ MHz}$

Fig 11. Power gain as a function of average load power; typical values

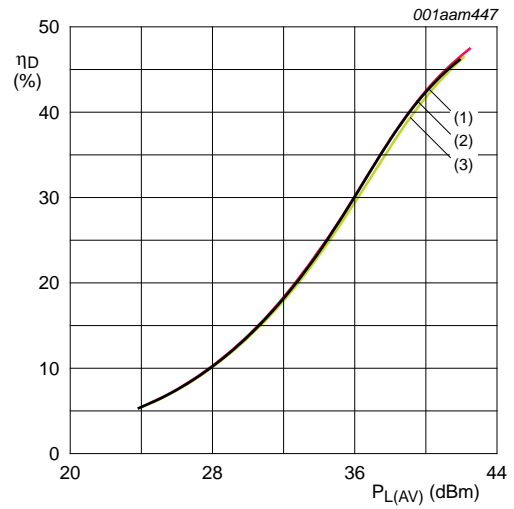

$V_{DS} = 28\text{ V}$; $I_{Dq} = 170\text{ mA}$ (main); $T_{case} = 25\text{ }^\circ\text{C}$;
 $V_{GS(amp)peak} = 0\text{ V}$; 2-carrier W-CDMA; PAR = 8.3 dB at 0.01 % probability on CCDF.

- (1) $f = 2110\text{ MHz}$
- (2) $f = 2140\text{ MHz}$
- (3) $f = 2170\text{ MHz}$

Fig 12. Drain efficiency as a function of average load power; typical values

9. Test information

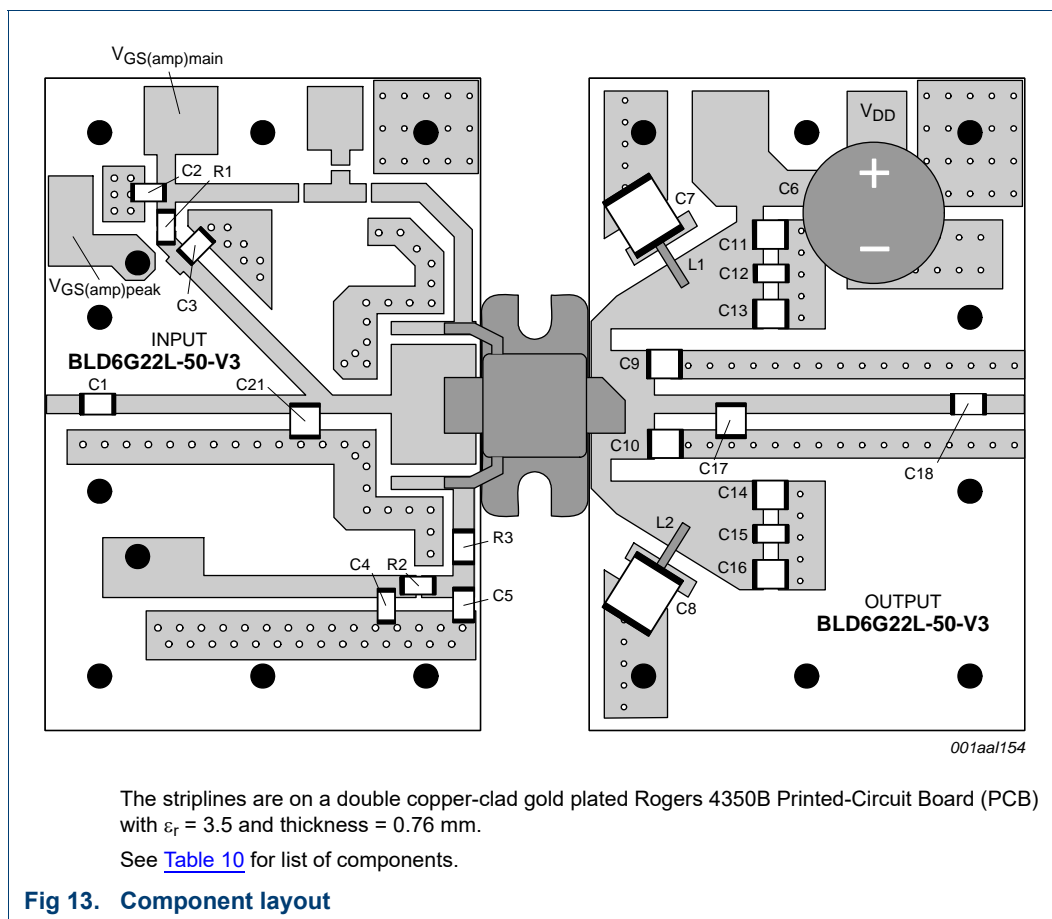

Table 10. List of components

See [Figure 13](#) for component layout.

Component	Description	Value	Dimensions
C1, C3, C5, C18	multilayer ceramic chip capacitor	9.1 pF	[1]
C2, C4, C12, C15	multilayer ceramic chip capacitor	100 nF	
C6	electrolytic capacitor	470 μ F; 63 V	
C7, C8	multilayer ceramic chip capacitor	10 μ F	
C9, C10	multilayer ceramic chip capacitor	1.2 pF	[1]
C11, C13, C14, C16	multilayer ceramic chip capacitor	8.2 pF	[1]
C17	multilayer ceramic chip capacitor	0.8 pF	[1]
C21	multilayer ceramic chip capacitor	1.0 pF	[1]
L1, L2	copper wire	-	diameter = 0.8 mm; length = 8 mm
R1	SMD resistor	3.6 Ω	1206
R2	SMD resistor	33 Ω	1206
R3	SMD resistor	10 Ω	1206

[1] American Technical Ceramics type 100B or capacitor of same quality.

10. Package outline

Flanged ceramic package; 2 mounting holes; 4 leads

SOT1130A

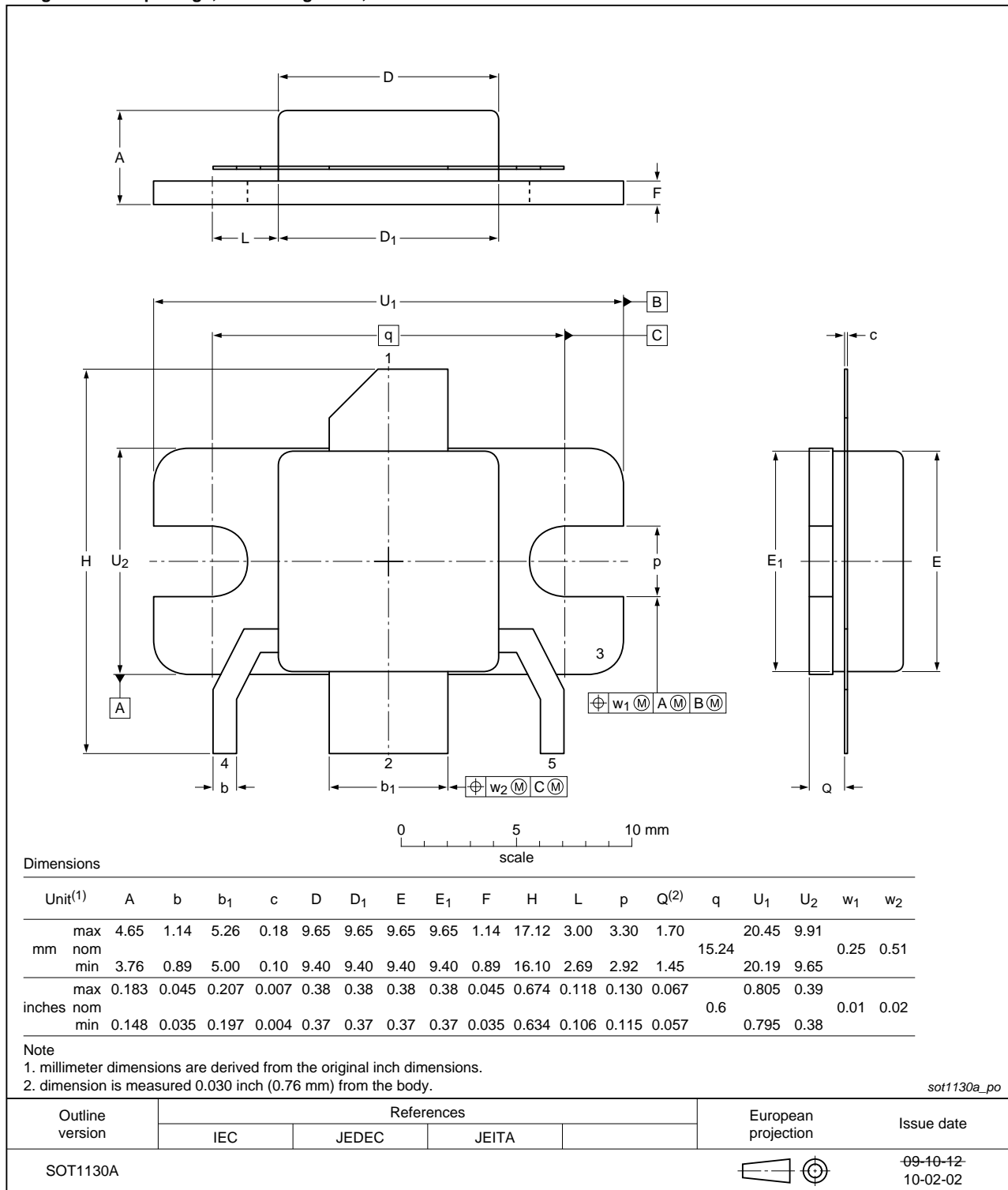

Fig 14. Package outline SOT1130A

Earless flanged ceramic package; 4 leads

SOT1130B

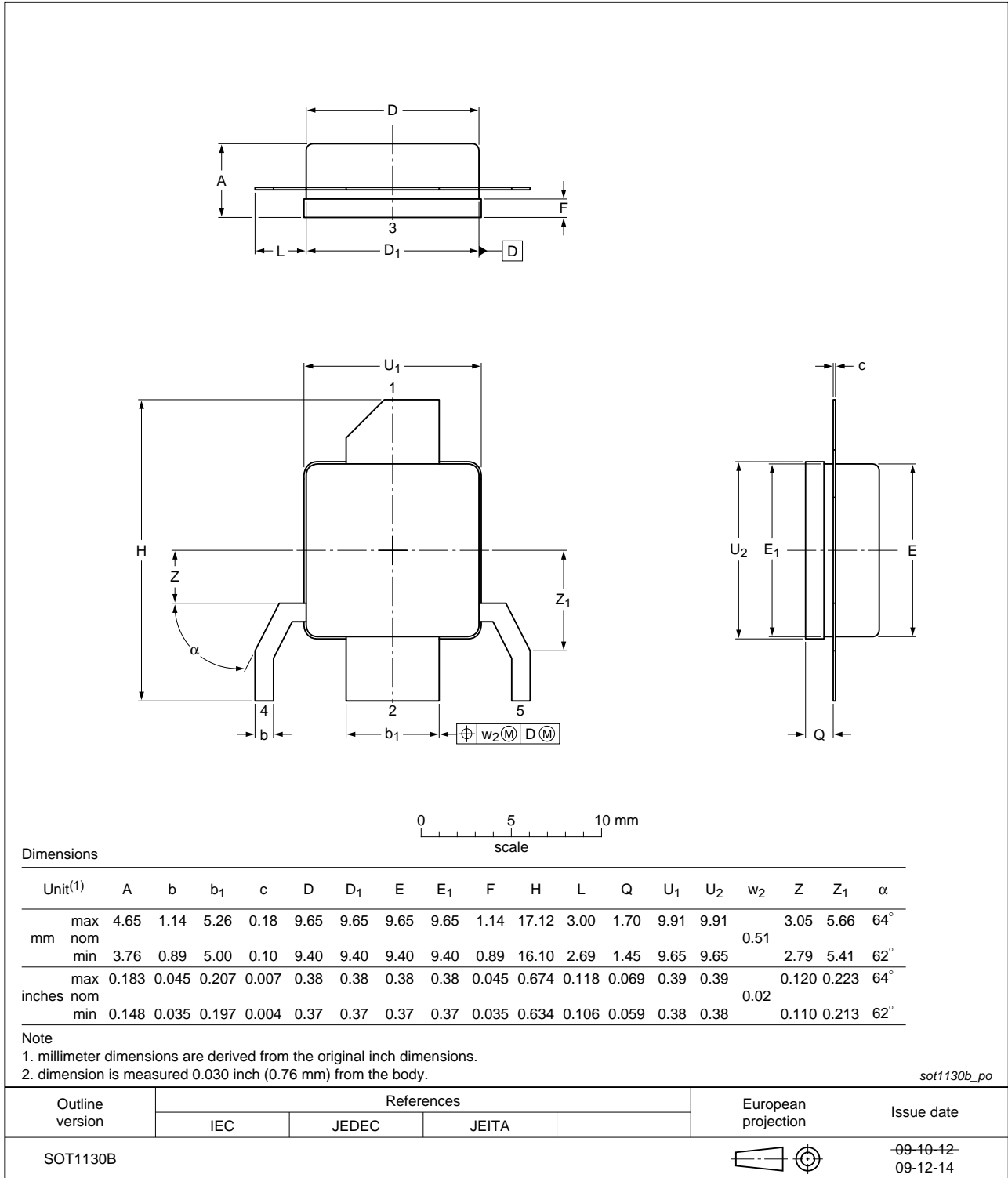

Fig 15. Package outline SOT1130B

11. Abbreviations

Table 11. Abbreviations

Acronym	Description
CCDF	Complementary Cumulative Distribution Function
CDMA	Code Division Multiple Access
CW	Continuous Wave
DPCH	Dedicated Physical CHannel
LDMOS	Laterally Diffused Metal-Oxide Semiconductor
PAR	Peak-to-Average power Ratio
RF	Radio Frequency
SMD	Surface Mounted Device
VSWR	Voltage Standing-Wave Ratio
W-CDMA	Wideband Code Division Multiple Access

12. Revision history

Table 12. Revision history

Document ID	Release date	Data sheet status	Change notice	Supersedes
BLD6G22L-50_BLD6G22LS-50#4	20150901	Product data sheet	-	BLD6G22L-50_BLD6G22LS-50 v.3
Modifications:	<ul style="list-style-type: none"> The format of this document has been redesigned to comply with the new identity guidelines of Ampleon. Legal texts have been adapted to the new company name where appropriate. 			
BLD6G22L-50_BLD6G22LS-50 v.3	20100817	Product data sheet	-	BLD6G22L-50_BLD6G22LS-50 v.2
BLD6G22L-50_BLD6G22LS-50 v.2	20100318	Objective data sheet	-	BLD6G22L-50_BLD6G22LS-50 v.1
BLD6G22L-50_BLD6G22LS-50 v.1	20091215	Objective data sheet	-	-

13. Legal information

13.1 Data sheet status

Document status ^{[1][2]}	Product status ^[3]	Definition
Objective [short] data sheet	Development	This document contains data from the objective specification for product development.
Preliminary [short] data sheet	Qualification	This document contains data from the preliminary specification.
Product [short] data sheet	Production	This document contains the product specification.

[1] Please consult the most recently issued document before initiating or completing a design.

[2] The term 'short data sheet' is explained in section "Definitions".

[3] The product status of device(s) described in this document may have changed since this document was published and may differ in case of multiple devices. The latest product status information is available on the Internet at URL <http://www.ampleon.com>.

13.2 Definitions

Draft — The document is a draft version only. The content is still under internal review and subject to formal approval, which may result in modifications or additions. Ampleon does not give any representations or warranties as to the accuracy or completeness of information included herein and shall have no liability for the consequences of use of such information.

Short data sheet — A short data sheet is an extract from a full data sheet with the same product type number(s) and title. A short data sheet is intended for quick reference only and should not be relied upon to contain detailed and full information. For detailed and full information see the relevant full data sheet, which is available on request via the local Ampleon sales office. In case of any inconsistency or conflict with the short data sheet, the full data sheet shall prevail.

Product specification — The information and data provided in a Product data sheet shall define the specification of the product as agreed between Ampleon and its customer, unless Ampleon and customer have explicitly agreed otherwise in writing. In no event however, shall an agreement be valid in which the Ampleon product is deemed to offer functions and qualities beyond those described in the Product data sheet.

13.3 Disclaimers

Limited warranty and liability — Information in this document is believed to be accurate and reliable. However, Ampleon does not give any representations or warranties, expressed or implied, as to the accuracy or completeness of such information and shall have no liability for the consequences of use of such information. Ampleon takes no responsibility for the content in this document if provided by an information source outside of Ampleon.

In no event shall Ampleon be liable for any indirect, incidental, punitive, special or consequential damages (including - without limitation - lost profits, lost savings, business interruption, costs related to the removal or replacement of any products or rework charges) whether or not such damages are based on tort (including negligence), warranty, breach of contract or any other legal theory.

Notwithstanding any damages that customer might incur for any reason whatsoever, Ampleon' aggregate and cumulative liability towards customer for the products described herein shall be limited in accordance with the *Terms and conditions of commercial sale* of Ampleon.

Right to make changes — Ampleon reserves the right to make changes to information published in this document, including without limitation specifications and product descriptions, at any time and without notice. This document supersedes and replaces all information supplied prior to the publication hereof.

Suitability for use — Ampleon products are not designed, authorized or warranted to be suitable for use in life support, life-critical or safety-critical systems or equipment, nor in applications where failure or malfunction of an

Ampleon product can reasonably be expected to result in personal injury, death or severe property or environmental damage. Ampleon and its suppliers accept no liability for inclusion and/or use of Ampleon products in such equipment or applications and therefore such inclusion and/or use is at the customer's own risk.

Applications — Applications that are described herein for any of these products are for illustrative purposes only. Ampleon makes no representation or warranty that such applications will be suitable for the specified use without further testing or modification.

Customers are responsible for the design and operation of their applications and products using Ampleon products, and Ampleon accepts no liability for any assistance with applications or customer product design. It is customer's sole responsibility to determine whether the Ampleon product is suitable and fit for the customer's applications and products planned, as well as for the planned application and use of customer's third party customer(s). Customers should provide appropriate design and operating safeguards to minimize the risks associated with their applications and products.

Ampleon does not accept any liability related to any default, damage, costs or problem which is based on any weakness or default in the customer's applications or products, or the application or use by customer's third party customer(s). Customer is responsible for doing all necessary testing for the customer's applications and products using Ampleon products in order to avoid a default of the applications and the products or of the application or use by customer's third party customer(s). Ampleon does not accept any liability in this respect.

Limiting values — Stress above one or more limiting values (as defined in the Absolute Maximum Ratings System of IEC 60134) will cause permanent damage to the device. Limiting values are stress ratings only and (proper) operation of the device at these or any other conditions above those given in the Recommended operating conditions section (if present) or the Characteristics sections of this document is not warranted. Constant or repeated exposure to limiting values will permanently and irreversibly affect the quality and reliability of the device.

Terms and conditions of commercial sale — Ampleon products are sold subject to the general terms and conditions of commercial sale, as published at <http://www.ampleon.com/terms>, unless otherwise agreed in a valid written individual agreement. In case an individual agreement is concluded only the terms and conditions of the respective agreement shall apply. Ampleon hereby expressly objects to applying the customer's general terms and conditions with regard to the purchase of Ampleon products by customer.

No offer to sell or license — Nothing in this document may be interpreted or construed as an offer to sell products that is open for acceptance or the grant, conveyance or implication of any license under any copyrights, patents or other industrial or intellectual property rights.

Export control — This document as well as the item(s) described herein may be subject to export control regulations. Export might require a prior authorization from competent authorities.

Non-automotive qualified products — Unless this data sheet expressly states that this specific Ampleon product is automotive qualified, the product is not suitable for automotive use. It is neither qualified nor tested in accordance with automotive testing or application requirements. Ampleon accepts no liability for inclusion and/or use of non-automotive qualified products in automotive equipment or applications.

In the event that customer uses the product for design-in and use in automotive applications to automotive specifications and standards, customer (a) shall use the product without Ampleon' warranty of the product for such automotive applications, use and specifications, and (b) whenever customer uses the product for automotive applications beyond Ampleon' specifications such use shall be solely at customer's own risk, and (c) customer fully indemnifies Ampleon for any liability, damages or failed product claims resulting from customer design and use of the product for automotive applications beyond Ampleon' standard warranty and Ampleon' product specifications.

14. Contact information

For more information, please visit:

<http://www.ampleon.com>

13.4 Trademarks

Notice: All referenced brands, product names, service names and trademarks are the property of their respective owners.

Any reference or use of any 'NXP' trademark in this document or in or on the surface of Ampleon products does not result in any claim, liability or entitlement vis-à-vis the owner of this trademark. Ampleon is no longer part of the NXP group of companies and any reference to or use of the 'NXP' trademarks will be replaced by reference to or use of Ampleon's own Any reference or use of any 'NXP' trademark in this document or in or on the surface of Ampleon products does not result in any claim, liability or entitlement vis-à-vis the owner of this trademark. Ampleon is no longer part of the NXP group of companies and any reference to or use of the 'NXP' trademarks will be replaced by reference to or use of Ampleon's own trademarks.

For sales office addresses, please visit:

<http://www.ampleon.com/sales>

15. Contents

1 Product profile 1

1.1 General description 1

1.2 Features and benefits 1

1.3 Applications 2

2 Pinning information 2

3 Ordering information 2

4 Block diagram 3

5 Limiting values 3

6 Thermal characteristics 3

7 Characteristics 3

8 Application information 4

8.1 Ruggedness in Doherty operation 4

8.2 Impedance information 4

8.3 Performance curves 5

8.3.1 CW pulsed 5

8.3.2 W-CDMA 7

9 Test information 9

10 Package outline 10

11 Abbreviations 12

12 Revision history 12

13 Legal information 13

13.1 Data sheet status 13

13.2 Definitions 13

13.3 Disclaimers 13

13.4 Trademarks 14

14 Contact information 14

15 Contents 15

Please be aware that important notices concerning this document and the product(s) described herein, have been included in section 'Legal information'.

© Ampleon The Netherlands B.V. 2015. All rights reserved.

For more information, please visit: <http://www.ampleon.com>
 For sales office addresses, please visit: <http://www.ampleon.com/sales>

Date of release: 1 September 2015

Document identifier: BLD6G22L-50_BLD6G22LS-50#4

Looking for pricing, stock, or lifecycle information?

Click below to explore more details on WIN SOURCE:

- ⊖ [View BLD6G22LS-50,112 on WIN SOURCE](#)
- ⊖ [Ampleon USA Inc. Information](#)

Optimize Your Supply Chain with WIN SOURCE Solutions

- ✓ Global Sourcing Solution
- ✓ Obsolete Management
- ✓ Cost Control Management
- ✓ Shortage Management
- ✓ Alternative Solution
- ✓ Excess Inventory Management