



**THE DATASHEET OF
BLF2045,112**



BLF2045

UHF power LDMOS transistor

Rev. 7 — 1 September 2015

AMPLEON

Product data sheet

IMPORTANT NOTICE

Dear customer,

As of December 7th, 2015 BL RF Power of NXP Semiconductors will operate as an independent company under the new trade name Ampleon, which will be used in future data sheets together with new contact details.

In data sheets, where the previous Philips references is mentioned, please use the new links as shown below.

<http://www.philips.semiconductors.com> use <http://www.ampleon.com>

<http://www.semiconductors.philips.com> use <http://www.ampleon.com> (Internet)

sales.addresses@www.semiconductors.philips.com use
<http://www.ampleon.com/sales>

The copyright notice at the bottom of each page (or elsewhere in the document, depending on the version)

- © Koninklijke Philips Electronics N.V. (year). All rights reserved -
is replaced with:

- © Ampleon B.V. (year). All rights reserved. -

If you have any questions related to the data sheet, please contact our nearest sales office (details via <http://www.ampleon.com/sales>).

Thank you for your cooperation and understanding,

Ampleon

UHF power LDMOS transistor

BLF2045

FEATURES

- Typical 2-tone performance at a supply voltage of 26 V and I_{DQ} of 500 mA
 - Output power = 30 W (PEP)
 - Gain = 12.5 dB
 - Efficiency = 32%
 - $d_{im} = -26$ dBc.
- Easy power control
- Excellent ruggedness
- High power gain
- Excellent thermal stability
- Designed for broadband operation (1800 to 2200 MHz)
- No internal matching for broadband operation.

APPLICATIONS

- RF power amplifiers for GSM, EDGE, CDMA and W-CDMA base stations and multicarrier applications in the 1800 to 2200 MHz frequency range
- Broadcast drivers.

DESCRIPTION

30 W LDMOS power transistor for base station applications at frequencies from 1800 to 2200 MHz.

PINNING

PIN	DESCRIPTION
1	drain
2	gate
3	source, connected to flange

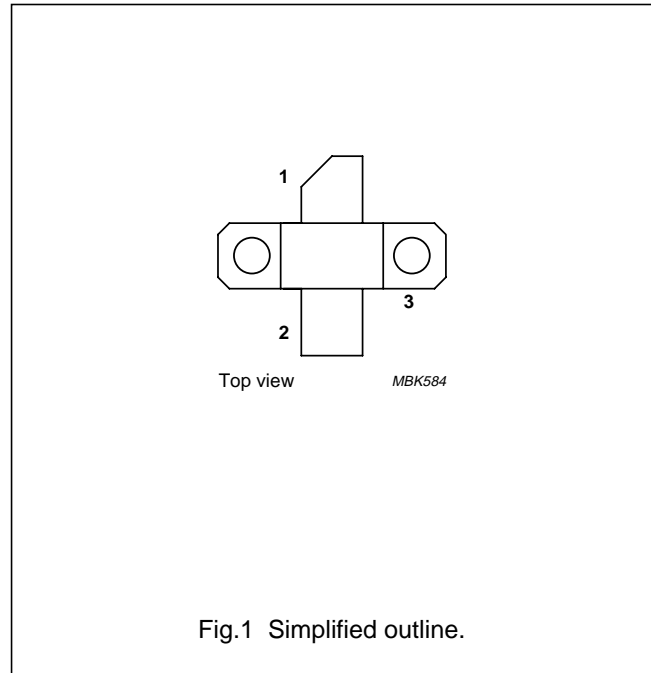

ORDERING INFORMATION

TYPE NUMBER	PACKAGE		
	NAME	DESCRIPTION	VERSION
BLF2045	–	plastic surface mounted package; 3 leads	SOT467C

QUICK REFERENCE DATA

RF performance at $T_h = 25$ °C in a common source test circuit.

MODE OF OPERATION	f (MHz)	V_{DS} (V)	P_L (W)	G_p (dB)	η_D (%)	d_{im} (dBc)
2-tone, class-AB	$f_1 = 2000; f_2 = 2000.1$	26	30 (PEP)	>10	>30	≤ -25

CAUTION

This product is supplied in anti-static packing to prevent damage caused by electrostatic discharge during transport and handling. For further information, refer to Philips specs.: SNW-EQ-608, SNW-FQ-302A and SNW-FQ-302B.

UHF power LDMOS transistor

BLF2045

LIMITING VALUES

In accordance with the Absolute Maximum Rating System (IEC 60134).

SYMBOL	PARAMETER	MIN.	MAX.	UNIT
V_{DS}	drain-source voltage	–	65	V
V_{GS}	gate-source voltage	–	±15	V
I_D	drain current (DC)	–	4.5	A
T_{stg}	storage temperature	–65	+150	°C
T_j	junction temperature	–	200	°C

THERMAL CHARACTERISTICS

SYMBOL	PARAMETER	CONDITIONS	VALUE	UNIT
$R_{th(j-h)}$	thermal resistance from junction to heatsink	$P_{tot} = 87.5 \text{ W}$; $T_h = 25 \text{ °C}$; note 1	2.1	K/W

Note

1. Thermal resistance is determined under specified RF operating conditions.

UHF power LDMOS transistor

BLF2045

CHARACTERISTICS

$T_j = 25\text{ }^\circ\text{C}$ unless otherwise specified.

SYMBOL	PARAMETER	CONDITIONS	MIN.	TYP.	MAX.	UNIT
$V_{(BR)DSS}$	drain-source breakdown voltage	$V_{GS} = 0; I_D = 0.7\text{ mA}$	65	–	–	V
V_{GSth}	gate-source threshold voltage	$V_{DS} = 10\text{ V}; I_D = 70\text{ mA}$	1.5	–	3.5	V
I_{DSS}	drain-source leakage current	$V_{GS} = 0; V_{DS} = 26\text{ V}$	–	–	5	μA
I_{DSX}	drain cut-off current	$V_{GS} = V_{GSth} + 9\text{ V}; V_{DS} = 10\text{ V}$	9	–	–	A
I_{GSS}	gate leakage current	$V_{GS} = \pm 15\text{ V}; V_{DS} = 0$	–	–	125	nA
g_{fs}	forward transconductance	$V_{DS} = 10\text{ V}; I_D = 2.5\text{ A}$	–	2	–	S
R_{DSon}	drain-source on-state resistance	$V_{GS} = V_{GSth} + 9\text{ V}; I_D = 2.5\text{ A}$	–	340	–	$\text{m}\Omega$
C_{iss}	input capacitance	$V_{GS} = 0; V_{DS} = 26\text{ V}; f = 1\text{ MHz}$	–	38	–	pF
C_{oss}	output capacitance	$V_{GS} = 0; V_{DS} = 26\text{ V}; f = 1\text{ MHz}$	–	31	–	pF
C_{rss}	feedback capacitance	$V_{GS} = 0; V_{DS} = 26\text{ V}; f = 1\text{ MHz}$	–	1.7	–	pF

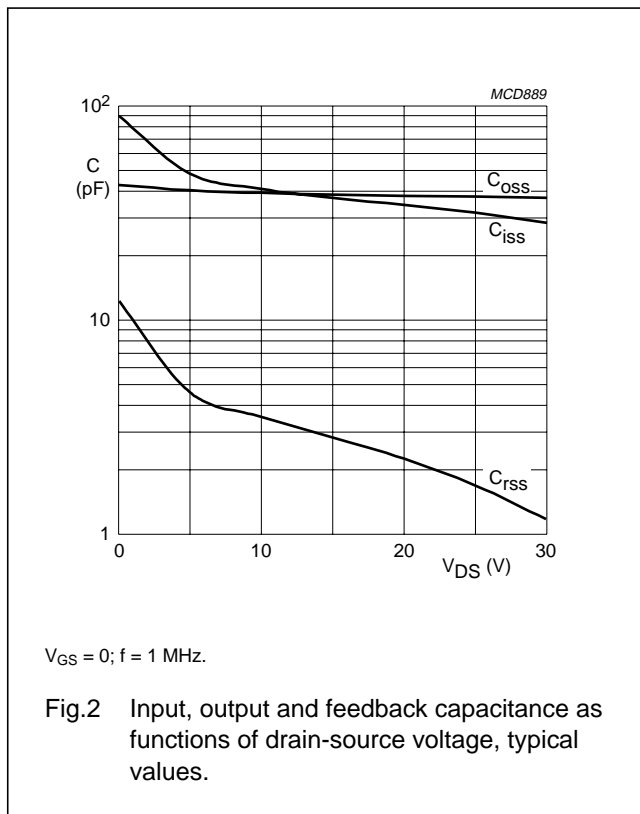

UHF power LDMOS transistor

BLF2045

APPLICATION INFORMATION

RF performance in a common source class-AB circuit. $T_h = 25\text{ }^\circ\text{C}$; $R_{th(mb-h)} = 0.65\text{ K/W}$, unless otherwise specified.

MODE OF OPERATION	f (MHz)	V_{DS} (V)	I_{DQ} (mA)	P_L (W)	G_p (dB)	η_D (%)	d_{im} (dBc)
2-tone, class-AB	$f_1 = 2000$; $f_2 = 2000.1$	26	180	30 (PEP)	>10	>30	≤ -25

Ruggedness in class-AB operation

The BLF2045 is capable of withstanding a load mismatch corresponding to $VSWR = 10 : 1$ through all phases under the following conditions: $V_{DS} = 26\text{ V}$; $P_L = 30\text{ W (CW)}$; $f = 2000\text{ MHz}$.

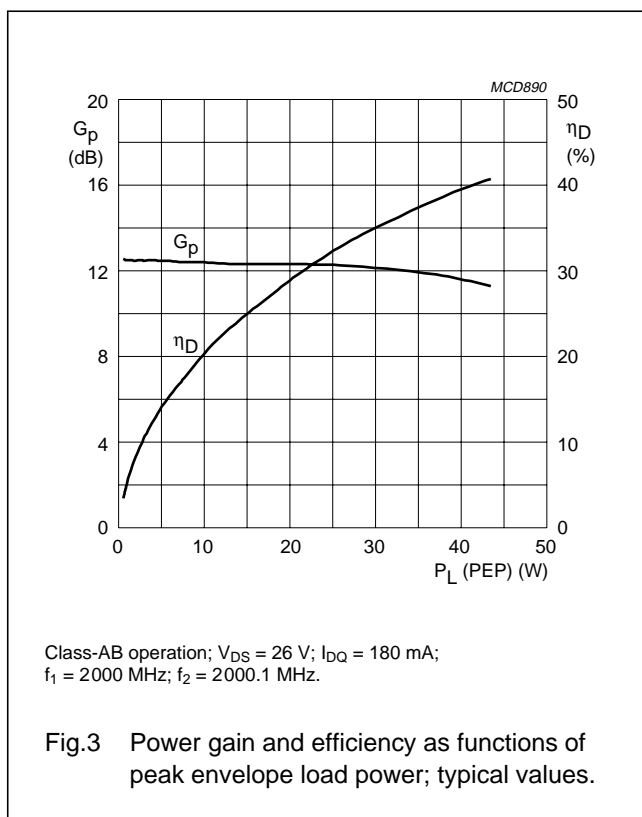

UHF power LDMOS transistor

BLF2045

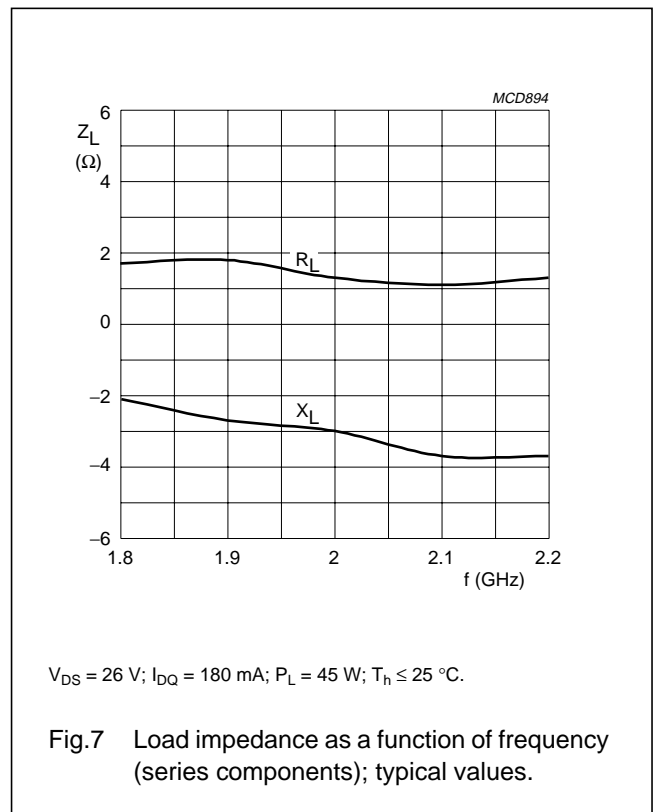
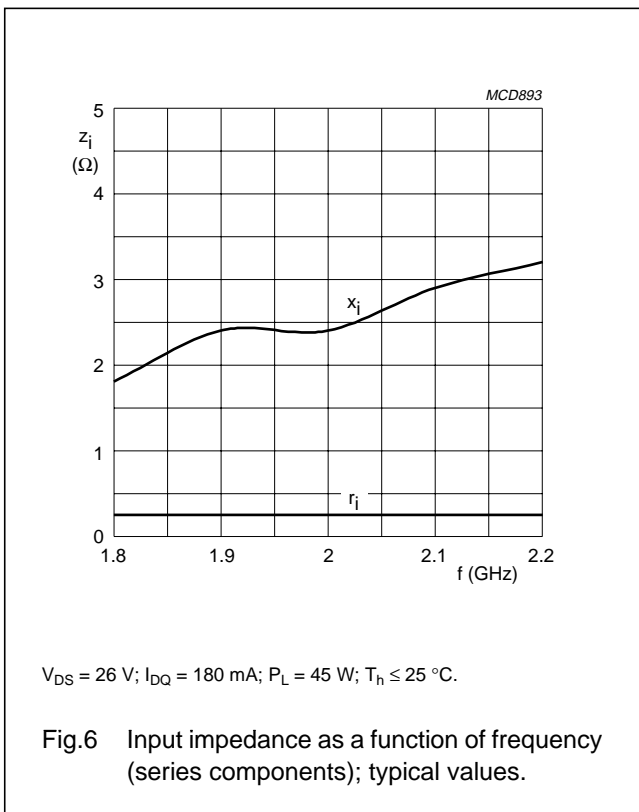
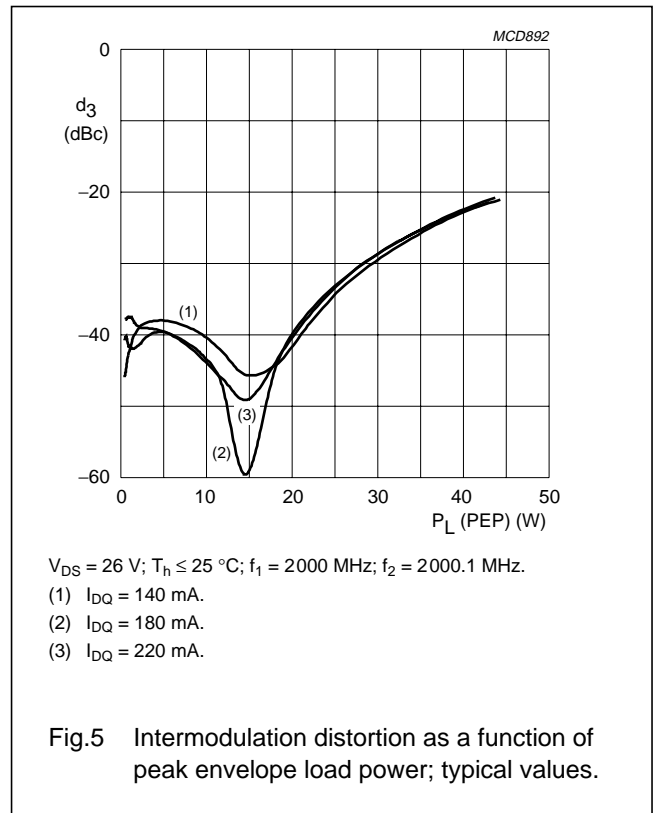
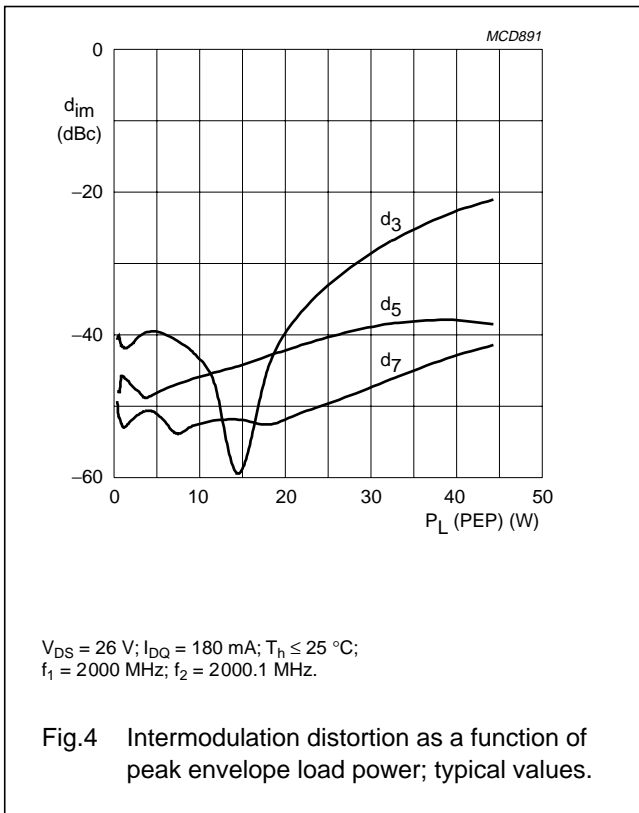

UHF power LDMOS transistor

BLF2045

List of components (see Figs 8 and 9)

COMPONENT	DESCRIPTION	VALUE	DIMENSIONS	CATALOGUE NO.
C2, C4, C7 and C8	Tekelec variable capacitor; type 37281	0.4 to 2.5 pF		
C3	multilayer ceramic chip capacitor; note 1	2.4 pF		
C1, C5, C9 and C10	multilayer ceramic chip capacitor; note 1	11 pF		
C11	multilayer ceramic chip capacitor; note 2	1 nF		
C12	multilayer ceramic chip capacitor	100 nF		2222 581 16641
C6, C13, C14 and C15	tantalum SMD capacitor	4.5 μ F; 50 V		
C16	electrolytic capacitor	100 μ F; 63 V		2222 037 58101
F1	Ferroxcube chip-bead 8DS3/3/8/9-4S2			4330 030 36301
L1	stripline; note 3	50 Ω	13 \times 0.9 mm	
L2	stripline; note 3	50 Ω	2 \times 0.9 mm	
L3	stripline; note 3	34.3 Ω	15 \times 1.7 mm	
L4 and L12	stripline; note 3	50 Ω	37 \times 0.9 mm	
L5	stripline; note 3	34.3 Ω	6 \times 1.7 mm	
L6	stripline; note 3	23.6 Ω	13 \times 2.9 mm	
L7	stripline; note 3	5.6 Ω	6 \times 15.8 mm	
L8	stripline; note 3	3.5 Ω	6 \times 26 mm	
L9	stripline; note 3	31.9 Ω	12 \times 1.9 mm	
L10	stripline; note 3	24.9 Ω	7.4 \times 2.7 mm	
L11	stripline; note 3	50 Ω	3 \times 0.9 mm	
L13	stripline; note 3	50 Ω	4.15 \times 0.9 mm	
L14	stripline; note 3	26.3 Ω	2.5 \times 2.5 mm	
L15	stripline; note 3	50 Ω	2.8 \times 0.9 mm	
L16	stripline; note 3	50 Ω	14 \times 0.9 mm	
R1 and R2	metal film resistor	10 Ω , 0.6 W		2322 156 11009

Notes

1. American Technical Ceramics type 100A or capacitor of same quality.
2. American Technical Ceramics type 100B or capacitor of same quality.
3. The striplines are on a double copper-clad printed-circuit board with Teflon dielectric ($\epsilon_r = 6.15$); thickness 0.64 mm.

UHF power LDMOS transistor

BLF2045



Dimensions in mm.

The components are situated on one side of the copper-clad printed-circuit board with Teflon dielectric ($\epsilon_r = 6.15$), thickness 0.64 mm. The other side is unetched and serves as a ground plane.

Fig.9 Component layout for 2 GHz class-AB test circuit.

UHF power LDMOS transistor

BLF2045

PACKAGE OUTLINE

Flanged LDMOST ceramic package; 2 mounting holes; 2 leads

SOT467C

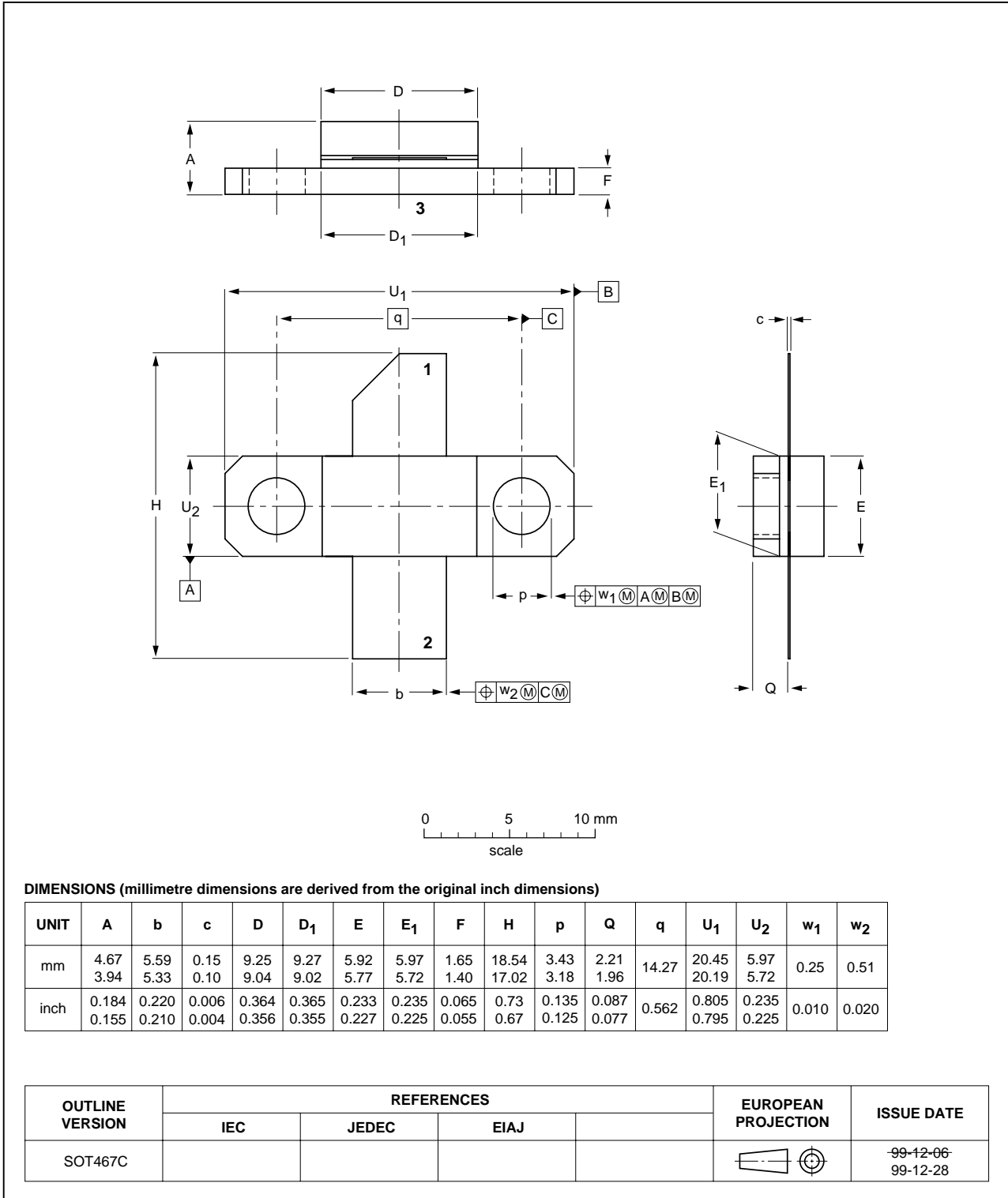

UHF power LDMOS transistor

BLF2045

DATA SHEET STATUS

LEVEL	DATA SHEET STATUS ⁽¹⁾	PRODUCT STATUS ⁽²⁾⁽³⁾	DEFINITION
I	Objective data	Development	This data sheet contains data from the objective specification for product development. Philips Semiconductors reserves the right to change the specification in any manner without notice.
II	Preliminary data	Qualification	This data sheet contains data from the preliminary specification. Supplementary data will be published at a later date. Philips Semiconductors reserves the right to change the specification without notice, in order to improve the design and supply the best possible product.
III	Product data	Production	This data sheet contains data from the product specification. Philips Semiconductors reserves the right to make changes at any time in order to improve the design, manufacturing and supply. Relevant changes will be communicated via a Customer Product/Process Change Notification (CPCN).

Notes

1. Please consult the most recently issued data sheet before initiating or completing a design.
2. The product status of the device(s) described in this data sheet may have changed since this data sheet was published. The latest information is available on the Internet at URL <http://www.semiconductors.philips.com>.
3. For data sheets describing multiple type numbers, the highest-level product status determines the data sheet status.

DEFINITIONS

Short-form specification — The data in a short-form specification is extracted from a full data sheet with the same type number and title. For detailed information see the relevant data sheet or data handbook.

Limiting values definition — Limiting values given are in accordance with the Absolute Maximum Rating System (IEC 60134). Stress above one or more of the limiting values may cause permanent damage to the device. These are stress ratings only and operation of the device at these or at any other conditions above those given in the Characteristics sections of the specification is not implied. Exposure to limiting values for extended periods may affect device reliability.

Application information — Applications that are described herein for any of these products are for illustrative purposes only. Philips Semiconductors make no representation or warranty that such applications will be suitable for the specified use without further testing or modification.

DISCLAIMERS

Life support applications — These products are not designed for use in life support appliances, devices, or systems where malfunction of these products can reasonably be expected to result in personal injury. Philips Semiconductors customers using or selling these products for use in such applications do so at their own risk and agree to fully indemnify Philips Semiconductors for any damages resulting from such application.

Right to make changes — Philips Semiconductors reserves the right to make changes in the products - including circuits, standard cells, and/or software - described or contained herein in order to improve design and/or performance. When the product is in full production (status 'Production'), relevant changes will be communicated via a Customer Product/Process Change Notification (CPCN). Philips Semiconductors assumes no responsibility or liability for the use of any of these products, conveys no licence or title under any patent, copyright, or mask work right to these products, and makes no representations or warranties that these products are free from patent, copyright, or mask work right infringement, unless otherwise specified.

Philips Semiconductors – a worldwide company

Contact information

For additional information please visit <http://www.semiconductors.philips.com>. Fax: +31 40 27 24825

For sales offices addresses send e-mail to: sales.addresses@www.semiconductors.philips.com.

© Koninklijke Philips Electronics N.V. 2004

SCA76

All rights are reserved. Reproduction in whole or in part is prohibited without the prior written consent of the copyright owner.

The information presented in this document does not form part of any quotation or contract, is believed to be accurate and reliable and may be changed without notice. No liability will be accepted by the publisher for any consequence of its use. Publication thereof does not convey nor imply any license under patent- or other industrial or intellectual property rights.

Printed in The Netherlands

R77/06/pp12

Date of release: 2004 Feb 11

Document order number: 9397 750 12539

Let's make things better.

**Philips
Semiconductors**



PHILIPS

Looking for pricing, stock, or lifecycle information?

Click below to explore more details on WIN SOURCE:

-  [View BLF2045,112 on WIN SOURCE](#)
-  [Ampleon USA Inc. Information](#)

Optimize Your Supply Chain with WIN SOURCE Solutions

-  Global Sourcing Solution
-  Obsolete Management
-  Cost Control Management
-  Shortage Management
-  Alternative Solution
-  Excess Inventory Management