



**THE DATASHEET OF
BLF548,112**



IMPORTANT NOTICE

Dear customer,

As of December 7th, 2015 BL RF Power of NXP Semiconductors will operate as an independent company under the new trade name Ampleon, which will be used in future data sheets together with new contact details.

In data sheets, where the previous Philips references is mentioned, please use the new links as shown below.

<http://www.philips.semiconductors.com> use <http://www.ampleon.com>

<http://www.semiconductors.philips.com> use <http://www.ampleon.com> (Internet)

sales.addresses@www.semiconductors.philips.com use
<http://www.ampleon.com/sales>

The copyright notice at the bottom of each page (or elsewhere in the document, depending on the version)

- © Koninklijke Philips Electronics N.V. (year). All rights reserved -
is replaced with:

- © Ampleon B.V. (year). All rights reserved. -

If you have any questions related to the data sheet, please contact our nearest sales office (details via <http://www.ampleon.com/sales>).

Thank you for your cooperation and understanding,

Ampleon

UHF push-pull power MOS transistor

BLF548

FEATURES

- High power gain
- Easy power control
- Good thermal stability
- Gold metallization ensures excellent reliability
- Designed for broadband operation.

DESCRIPTION

Dual push-pull silicon N-channel enhancement mode vertical D-MOS transistor designed for communications transmitter applications in the UHF frequency range.

The transistor is encapsulated in a 4-lead, SOT262A2 balanced flange package, with two ceramic caps. The mounting flange provides the common source connection for the transistors.

PIN CONFIGURATION

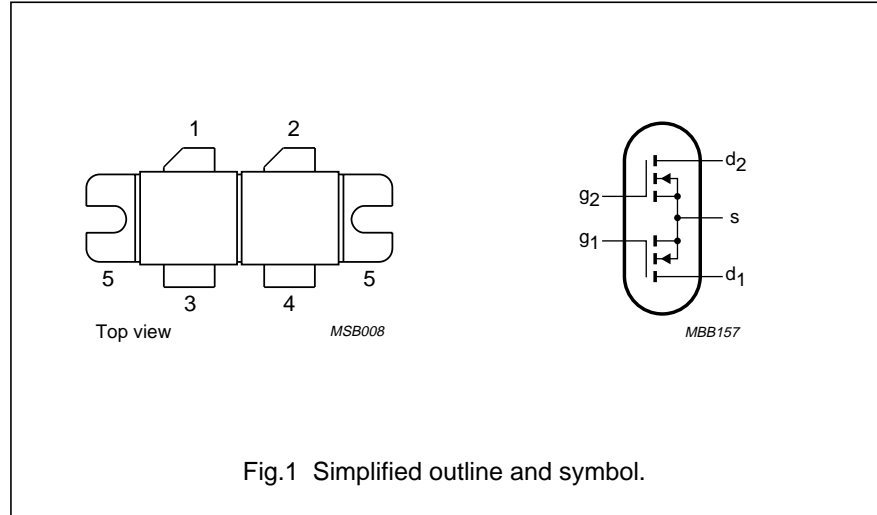

Fig.1 Simplified outline and symbol.

CAUTION

This product is supplied in anti-static packing to prevent damage caused by electrostatic discharge during transport and handling. For further information, refer to Philips specs.: SNW-EQ-608, SNW-FQ-302A, and SNW-FQ-302B.

PINNING - SOT262A2

PIN	DESCRIPTION
1	drain 1
2	drain 2
3	gate 1
4	gate 2
5	source

WARNING

Product and environmental safety - toxic materials

This product contains beryllium oxide. The product is entirely safe provided that the BeO discs are not damaged. All persons who handle, use or dispose of this product should be aware of its nature and of the necessary safety precautions. After use, dispose of as chemical or special waste according to the regulations applying at the location of the user. It must never be thrown out with the general or domestic waste.

QUICK REFERENCE DATA

RF performance at $T_h = 25\text{ }^\circ\text{C}$ in a push-pull common source test circuit.

MODE OF OPERATION	f (MHz)	V_{DS} (V)	P_L (W)	G_p (dB)	η_D (%)
CW, class-B	500	28	150	>10	>50

UHF push-pull power MOS transistor

BLF548

LIMITING VALUES

In accordance with the Absolute Maximum System (IEC 60134).

SYMBOL	PARAMETER	CONDITIONS	MIN.	MAX.	UNIT
Per transistor section unless otherwise specified					
V_{DS}	drain-source voltage		–	65	V
V_{GS}	gate-source voltage		–	± 20	V
I_D	drain current (DC)		–	15	A
P_{tot}	total power dissipation	$T_{mb} \leq 25\text{ }^\circ\text{C}$; total device; both sections equally loaded	–	330	W
T_{stg}	storage temperature		–65	+150	$^\circ\text{C}$
T_j	junction temperature		–	200	$^\circ\text{C}$

THERMAL CHARACTERISTICS

SYMBOL	PARAMETER	CONDITIONS	VALUE	UNIT
$R_{th\ j-mb}$	thermal resistance from junction to mounting base	$T_{mb} = 25\text{ }^\circ\text{C}$; $P_{tot} = 330\text{ W}$; total device; both sections equally loaded	0.5	K/W
$R_{th\ mb-h}$	thermal resistance from mounting base to heatsink	total device; both sections equally loaded	0.15	K/W

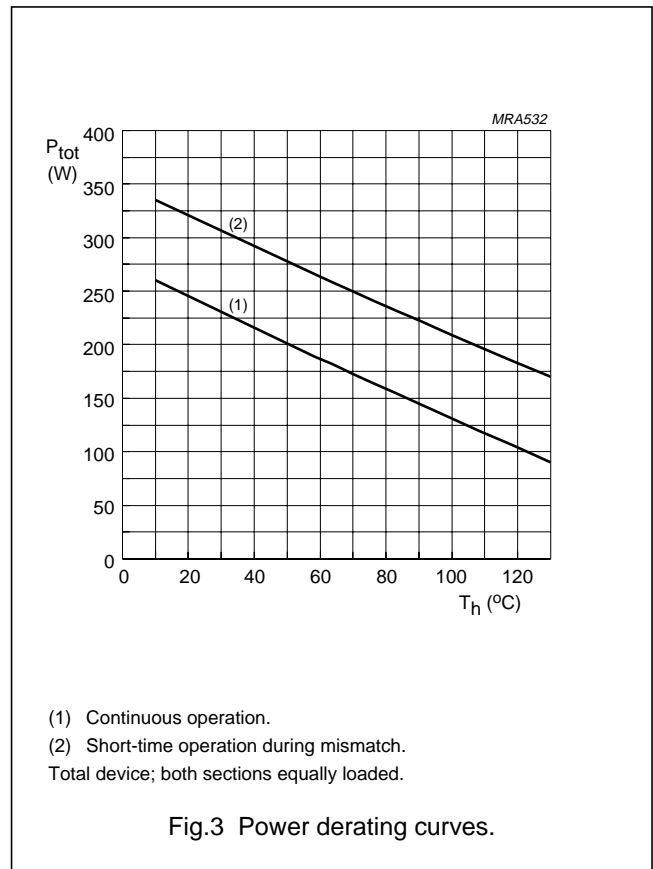
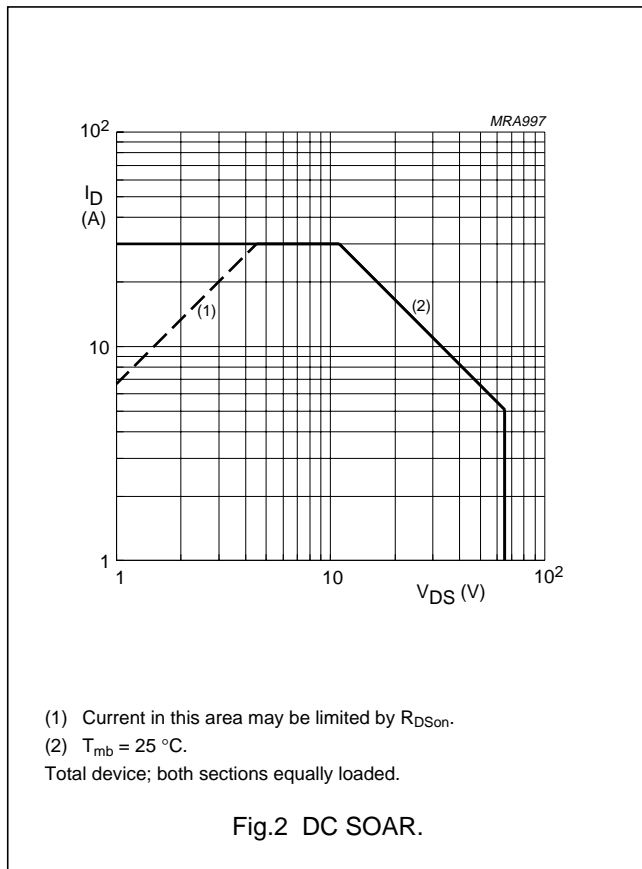

UHF push-pull power MOS transistor

BLF548

CHARACTERISTICS

 $T_j = 25\text{ }^\circ\text{C}$ unless otherwise specified.

SYMBOL	PARAMETER	CONDITIONS	MIN.	TYP.	MAX.	UNIT
Per transistor section						
$V_{(BR)DSS}$	drain-source breakdown voltage	$V_{GS} = 0; I_D = 40\text{ mA}$	65	–	–	V
I_{DSS}	drain-source leakage current	$V_{GS} = 0; V_{DS} = 28\text{ V}$	–	–	0.5	mA
I_{GSS}	gate-source leakage current	$V_{GS} = \pm 20\text{ V}; V_{DS} = 0$	–	–	1	μA
V_{GSth}	gate-source threshold voltage	$I_D = 160\text{ mA}; V_{DS} = 10\text{ V}$	2	–	4	V
g_{fs}	forward transconductance	$I_D = 4.8\text{ A}; V_{DS} = 10\text{ V}$	2.4	3.5	–	S
R_{DSon}	drain-source on-state resistance	$I_D = 4.8\text{ A}; V_{GS} = 10\text{ V}$	–	0.25	0.3	Ω
I_{DSX}	on-state drain current	$V_{GS} = 15\text{ V}; V_{DS} = 10\text{ V}$	16	20	–	A
C_{is}	input capacitance	$V_{GS} = 0; V_{DS} = 28\text{ V}; f = 1\text{ MHz}$	–	105	–	pF
C_{os}	output capacitance	$V_{GS} = 0; V_{DS} = 28\text{ V}; f = 1\text{ MHz}$	–	90	–	pF
C_{rs}	feedback capacitance	$V_{GS} = 0; V_{DS} = 28\text{ V}; f = 1\text{ MHz}$	–	25	–	pF

 V_{GS} group indicator

GROUP	LIMITS (V)		GROUP	LIMITS (V)	
	MIN.	MAX.		MIN.	MAX.
A	2.0	2.1	O	3.3	3.4
B	2.1	2.2	P	3.4	3.5
C	2.2	2.3	Q	3.5	3.6
D	2.3	2.4	R	3.6	3.7
E	2.4	2.5	S	3.7	3.8
F	2.5	2.6	T	3.8	3.9
G	2.6	2.7	U	3.9	4.0
H	2.7	2.8	V	4.0	4.1
J	2.8	2.9	W	4.1	4.2
K	2.9	3.0	X	4.2	4.3
L	3.0	3.1	Y	4.3	4.4
M	3.1	3.2	Z	4.4	4.5
N	3.2	3.3			

UHF push-pull power MOS transistor

BLF548

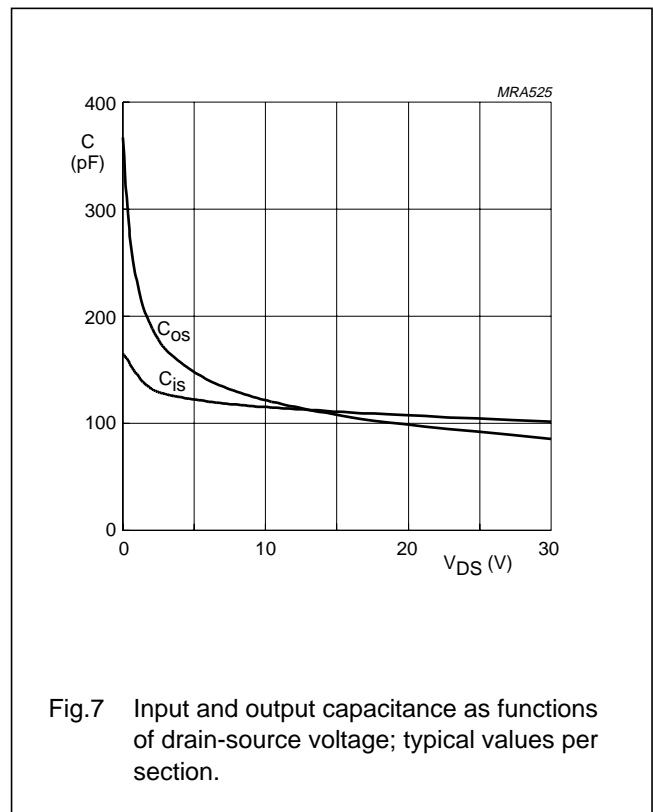
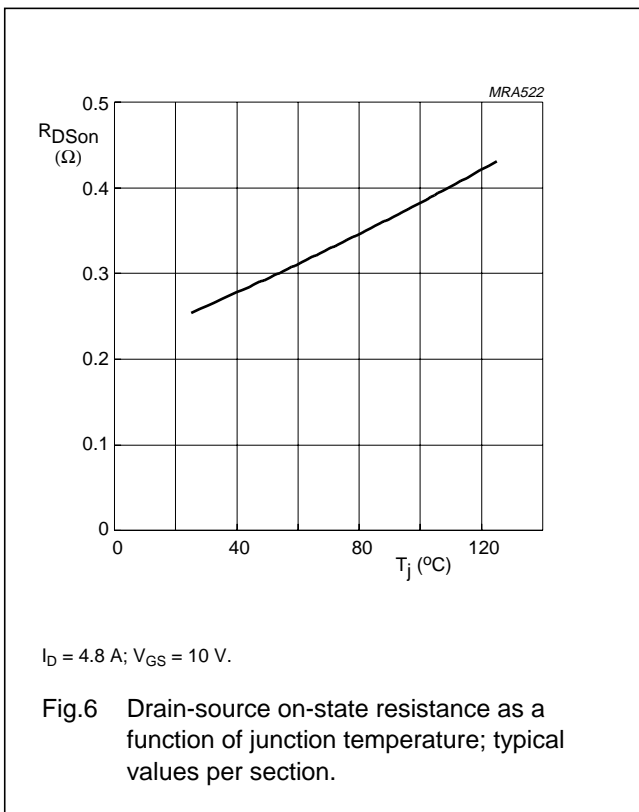
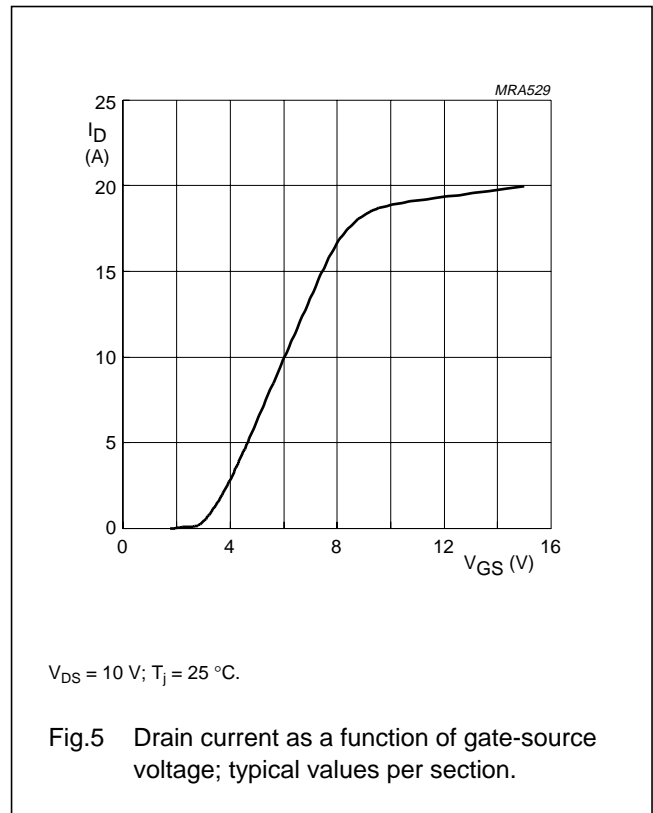
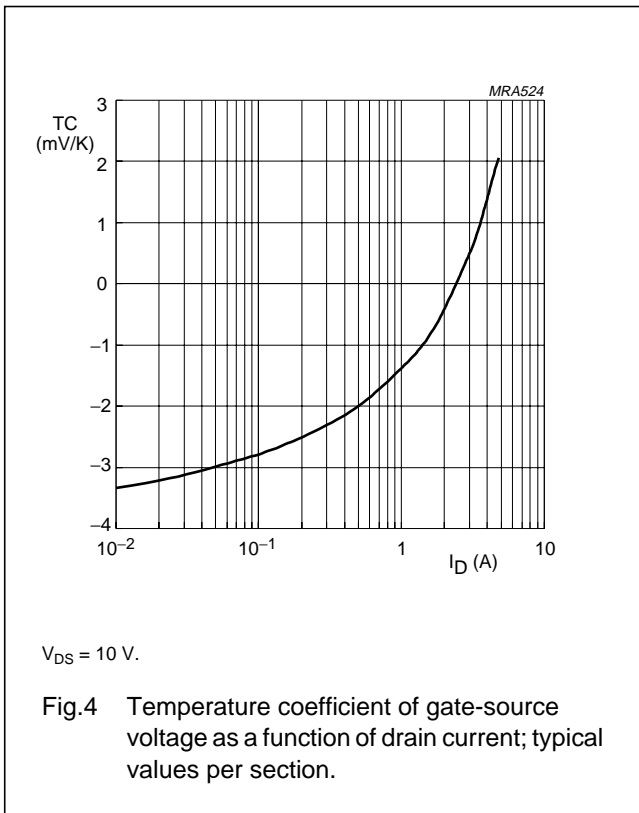

UHF push-pull power MOS transistor

BLF548

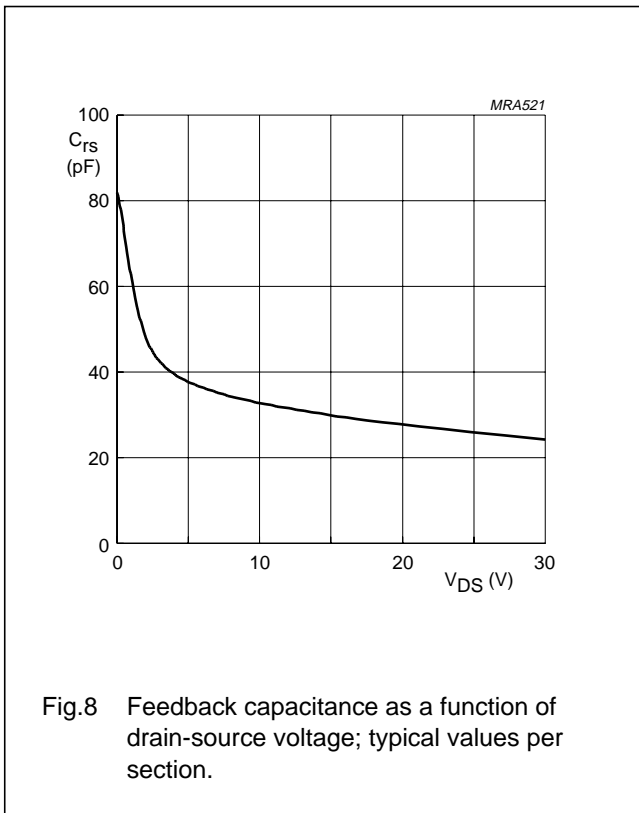

Fig.8 Feedback capacitance as a function of drain-source voltage; typical values per section.

APPLICATION INFORMATION FOR CLASS-B OPERATION

$T_h = 25\text{ }^\circ\text{C}$; $R_{th\text{ mb-h}} = 0.15\text{ K/W}$, unless otherwise specified.

RF performance in a common source, class-B, push-pull test circuit.

MODE OF OPERATION	f (MHz)	V_{DS} (V)	I_{DQ} (mA)	P_L (W)	G_p (dB)	η_D (%)
CW, class-B	500	28	2 x 160	150	>10 typ. 11	>50 typ. 55

Ruggedness in class-B operation

The BLF548 is capable of withstanding a load mismatch corresponding to $V_{SWR} = 10:1$ through all phases under the following conditions: $V_{DS} = 28\text{ V}$; $f = 500\text{ MHz}$ at rated output power.

UHF push-pull power MOS transistor

BLF548

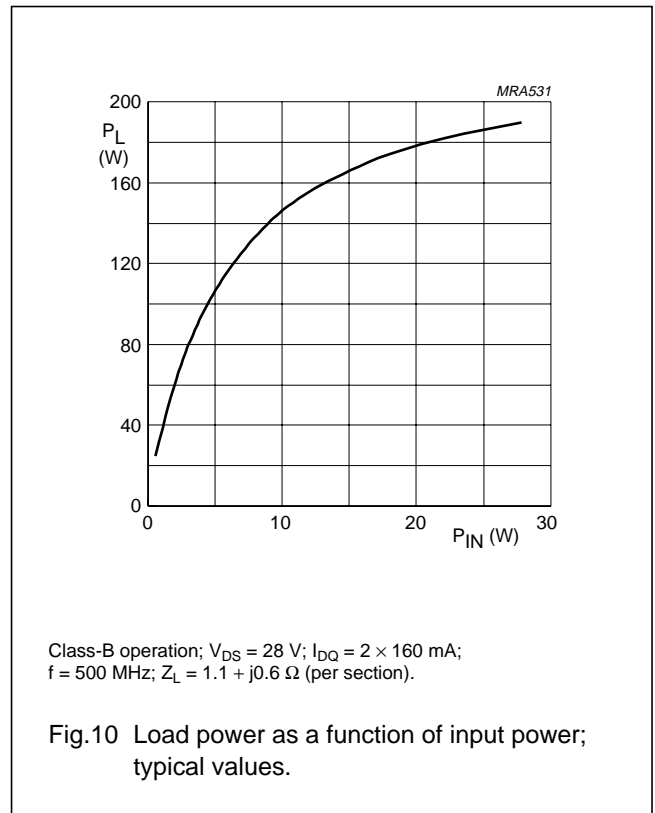
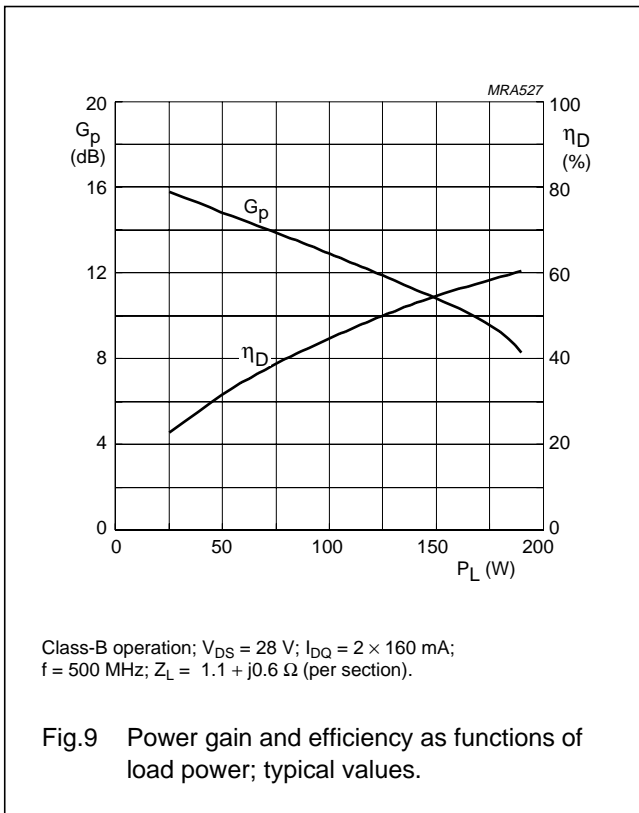

UHF push-pull power MOS transistor

BLF548

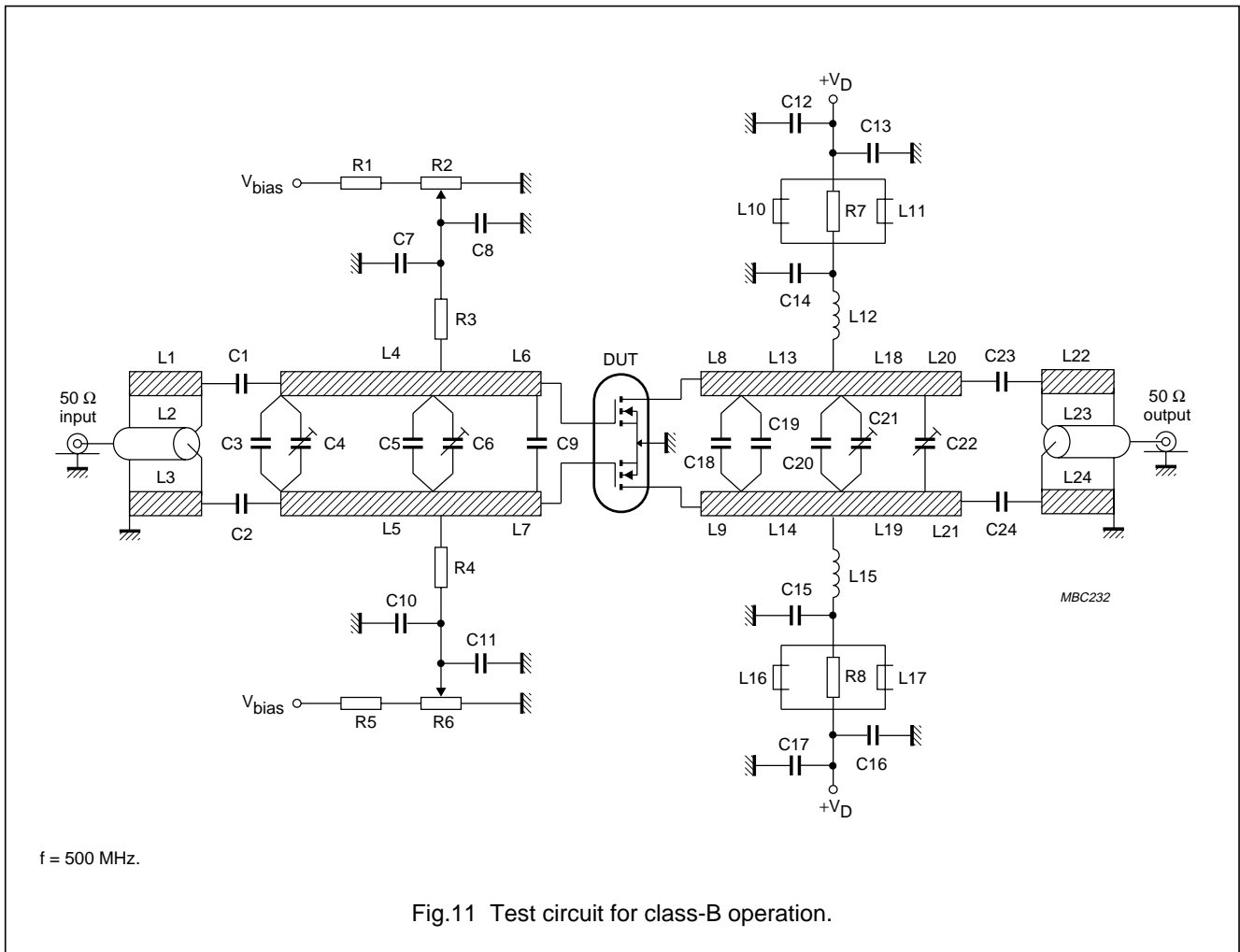

List of components class-B test circuit (see Fig.11)

COMPONENT	DESCRIPTION	VALUE	DIMENSIONS	CATALOGUE NO.
C1, C2	multilayer ceramic chip capacitor; note 1	22 pF		
C3	multilayer ceramic chip capacitor; note 1	16 pF		
C4	film dielectric trimmer	2 to 9 pF		2222 809 09005
C5	multilayer ceramic chip capacitor; note 2	27 pF		
C6, C21, C22	film dielectric trimmer	2 to 18 pF		2222 809 09006
C7, C10, C14, C15	multilayer ceramic chip capacitor; note 1	390 pF		
C8, C11, C12, C17	multilayer ceramic chip capacitor	100 nF		2222 852 47104
C9	multilayer ceramic chip capacitor; note 3	2 × 56 pF in series		

UHF push-pull power MOS transistor

BLF548

COMPONENT	DESCRIPTION	VALUE	DIMENSIONS	CATALOGUE NO.
C13, C16	electrolytic capacitor	10 μ F, 63 V		2222 030 38109
C18	multilayer ceramic chip capacitor; note 2	18 pF		
C19	multilayer ceramic chip capacitor; note 2	12 pF		
C20	multilayer ceramic chip capacitor; note 2	8.2 pF		
C23, C24	multilayer ceramic chip capacitor; note 1	30 pF		
L1, L3, L22, L24	stripline; note 4	34.5 Ω	length 66.5 mm width 4 mm	
L2, L23	semi-rigid cable; note 5	50 Ω	length 66.5 mm width 3.6 mm	
L4, L5	stripline; note 4	22.3 Ω	length 35 mm width 7 mm	
L6, L7	stripline; note 4	22.3 Ω	length 10 mm width 7 mm	
L8, L9	stripline; note 4	22.3 Ω	length 5.5 mm width 7 mm	
L10, L11, L16, L17	grade 3B Ferroxcube wideband RF choke			4312 020 36642
L12, L15	1 turn enamelled 1.5 mm copper wire	17 nH	length 5 mm int. dia. 9 mm leads 2 \times 5 mm	
L13, L14	stripline; note 4	22.3 Ω	length 15 mm width 7 mm	
L18, L19	stripline; note 4	22.3 Ω	length 36 mm width 7 mm	
L20, L21	stripline; note 4	22.3 Ω	length 8.5 mm width 7 mm	
R1, R5	0.4 W metal film resistor	24.7 k Ω		2322 151 72473
R2, R6	10 turn potentiometer	5 k Ω		
R3, R4	0.4 W metal film resistor	10.5 k Ω		2322 151 71053
R7, R8	1 W metal film resistor	10 Ω		2322 151 51009

Notes

- American Technical Ceramics (ATC) capacitor, type 100B or other capacitor of the same quality.
- American Technical Ceramics (ATC) capacitor, type 175B or other capacitor of the same quality.
- American Technical Ceramics (ATC) capacitor, type 100A or other capacitor of the same quality.
- The striplines are on a double copper-clad printed-circuit board, with PTFE fibre-glass dielectric ($\epsilon_r = 2.2$), thickness 0.79 mm.
- Cables L2 and L23 are soldered to striplines L1 and L22 respectively.

UHF push-pull power MOS transistor

BLF548

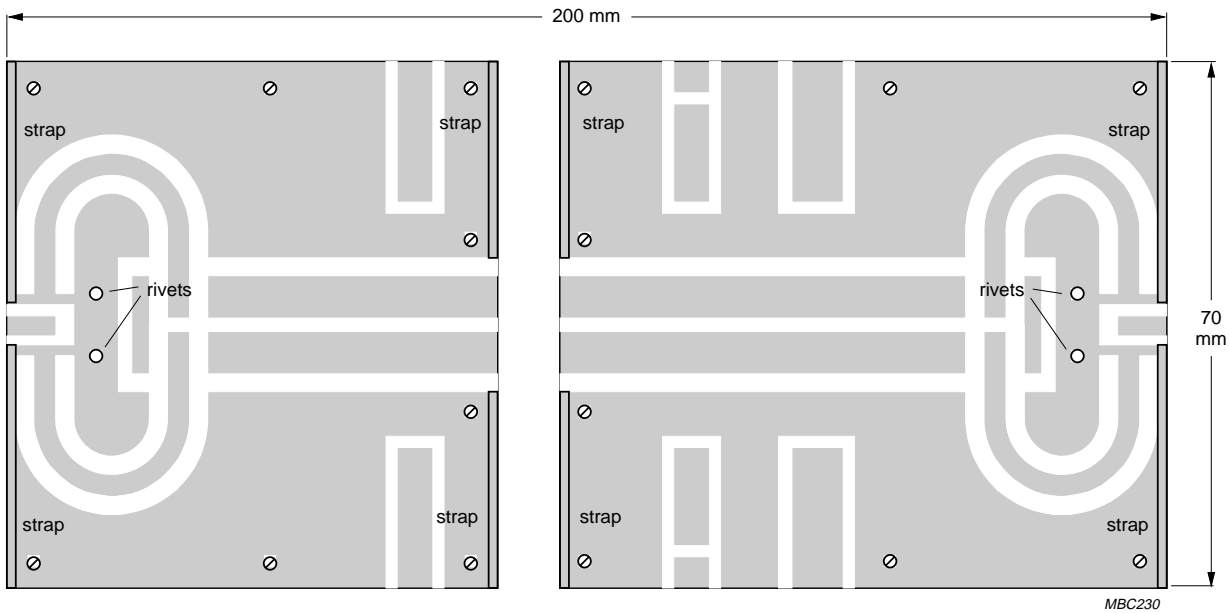
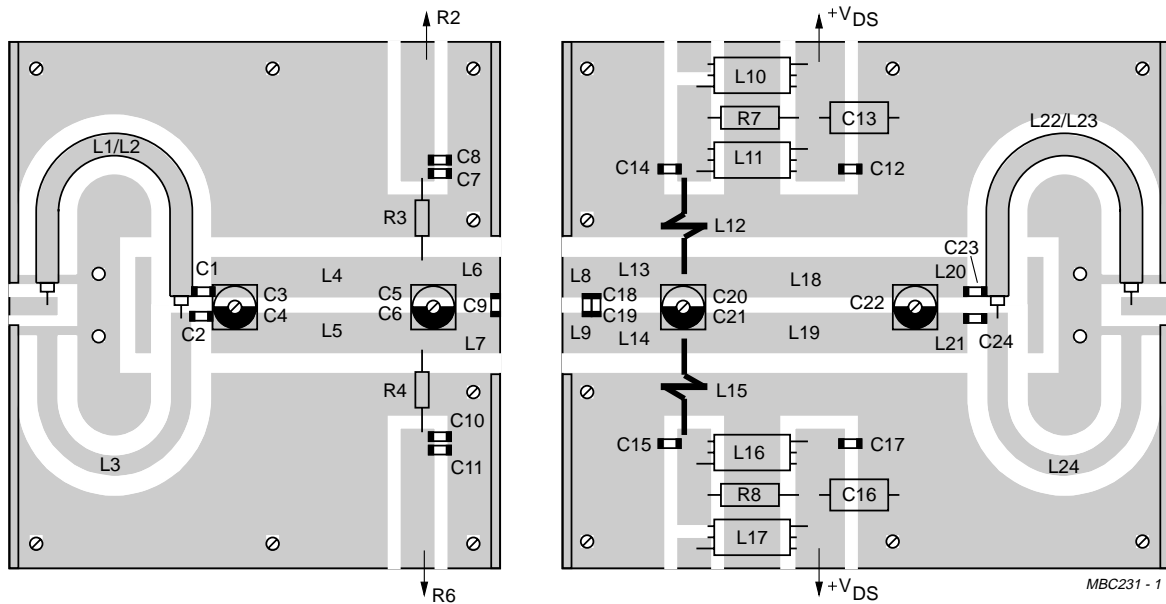

The circuit and components are situated on one side of the PTFE fibre-glass board, the other side being fully metallized to serve as a ground plane. Connections are made by means of copper straps and hollow rivets for a direct contact between upper and lower sheets.

Fig.12 Component layout for 500 MHz class-B test circuit.

UHF push-pull power MOS transistor

BLF548

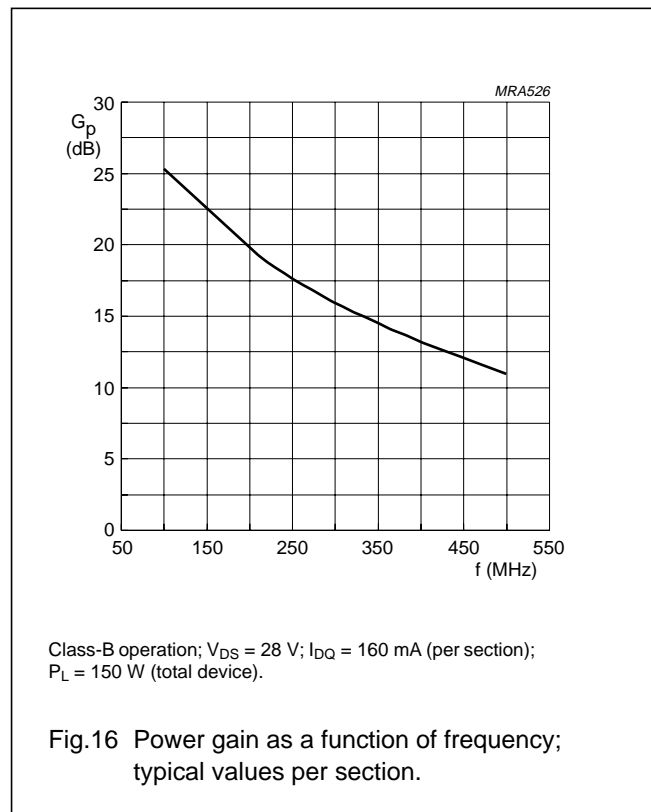
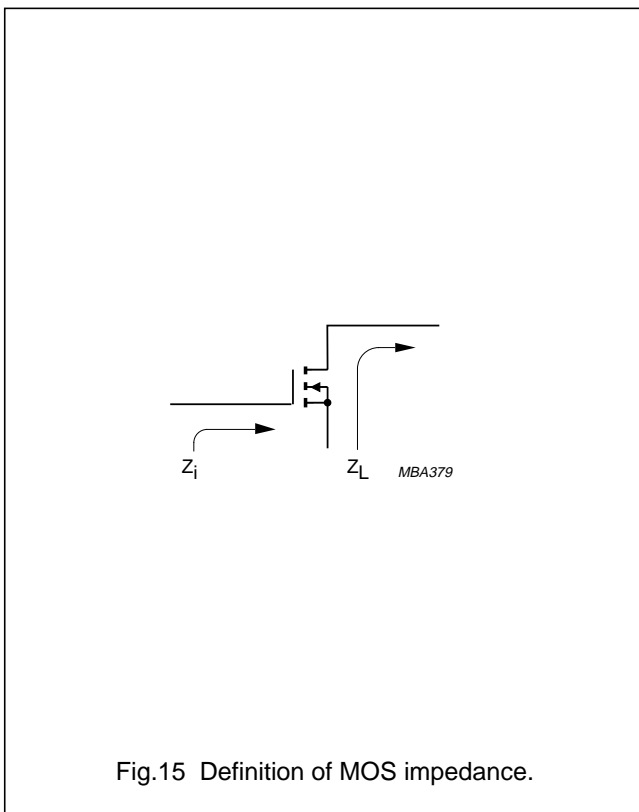
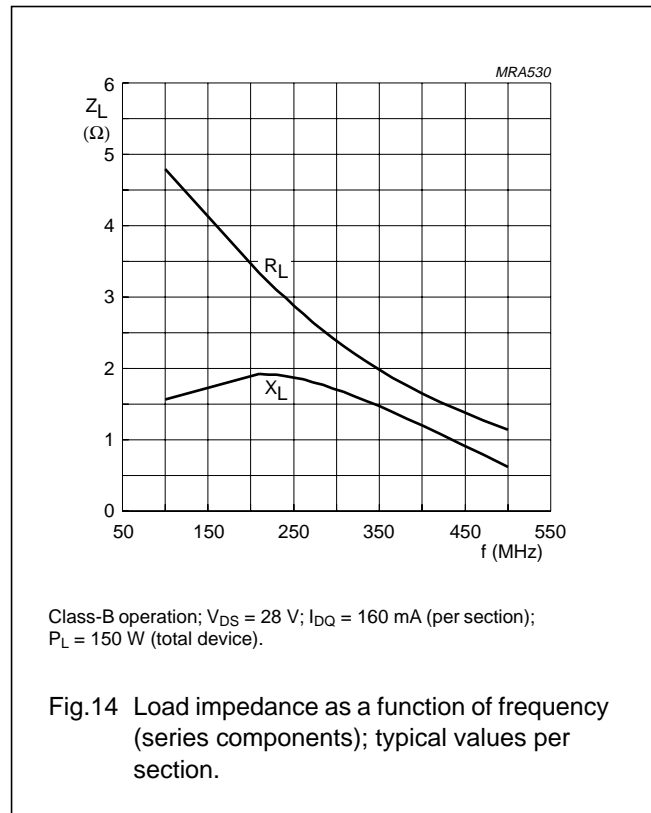
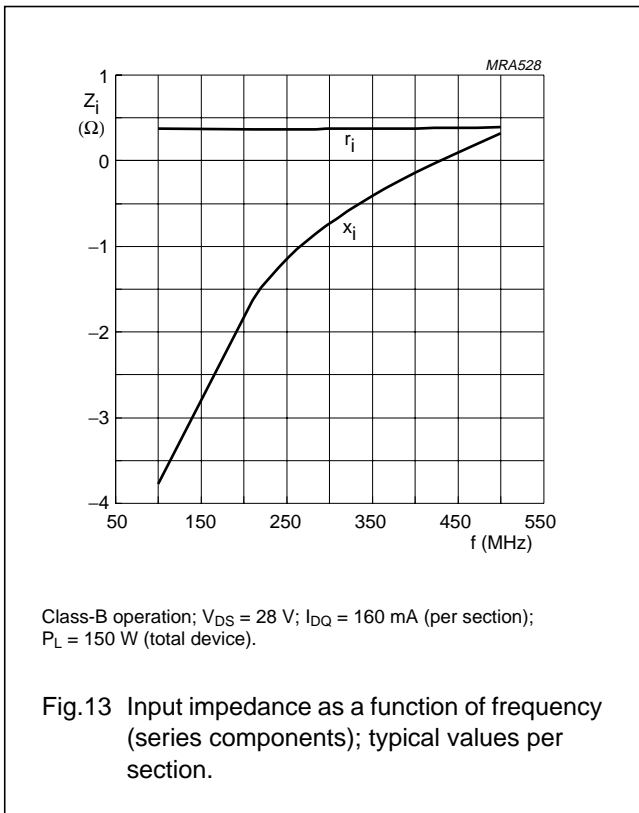

UHF push-pull power MOS transistor

BLF548

BLF548 scattering parameters $V_{DS} = 28\text{ V}$; $I_D = 40\text{ mA}$; note 1

f (MHz)	S ₁₁		S ₂₁		S ₁₂		S ₂₂	
	S ₁₁	∠ Φ	S ₂₁	∠ Φ	S ₁₂	∠ Φ	S ₂₂	∠ Φ
5	0.99	-14.0	13.60	171.0	0.02	81.0	0.89	-12.8
10	0.98	-27.6	13.20	162.0	0.04	72.4	0.87	-25.3
20	0.93	-52.0	11.90	146.0	0.07	57.1	0.82	-48.0
30	0.88	-72.0	10.30	134.0	0.09	44.8	0.77	-66.6
40	0.84	-87.7	8.93	124.0	0.10	35.2	0.72	-81.3
50	0.81	-100.0	7.75	116.0	0.11	27.7	0.68	-93.0
60	0.79	-110.0	6.78	110.0	0.12	21.6	0.66	-102.0
70	0.77	-118.0	6.00	104.0	0.12	16.7	0.64	-109.0
80	0.76	-124.0	5.36	99.8	0.12	12.5	0.63	-115.0
90	0.75	-129.0	4.82	95.9	0.12	8.9	0.62	-120.0
100	0.75	-133.0	4.37	92.3	0.13	5.7	0.61	-124.0
125	0.74	-141.0	3.53	84.7	0.13	-1.1	0.61	-131.0
150	0.74	-147.0	2.94	78.3	0.13	-6.6	0.61	-137.0
175	0.74	-151.0	2.50	72.6	0.12	-11.5	0.62	-140.0
200	0.75	-154.0	2.16	67.5	0.12	-15.8	0.64	-143.0
250	0.77	-159.0	1.67	58.4	0.12	-23.3	0.67	-148.0
300	0.78	-163.0	1.33	50.4	0.11	-29.7	0.70	-151.0
350	0.80	-167.0	1.09	43.1	0.10	-35.3	0.73	-154.0
400	0.82	-169.0	0.91	36.6	0.10	-40.3	0.75	-157.0
450	0.84	-172.0	0.77	30.6	0.09	-44.7	0.78	-160.0
500	0.85	-175.0	0.66	25.1	0.08	-48.6	0.80	-162.0
600	0.89	-179.0	0.50	15.6	0.07	-55.2	0.84	-167.0
700	0.90	177.0	0.39	7.5	0.06	-60.4	0.88	-170.0
800	0.92	173.0	0.32	0.6	0.05	-64.3	0.90	-174.0
900	0.93	169.0	0.26	-5.4	0.04	-67.3	0.92	-177.0
1000	0.94	166.0	0.22	-10.8	0.04	-69.2	0.93	-179.0

Note

- For more extensive s-parameters see internet:
<http://www.semiconductors.philips.com/markets/communications/wirelesscommunications/broadcast>

UHF push-pull power MOS transistor

BLF548

PACKAGE OUTLINE

Flanged double-ended ceramic package; 2 mounting holes; 4 leads

SOT262A2

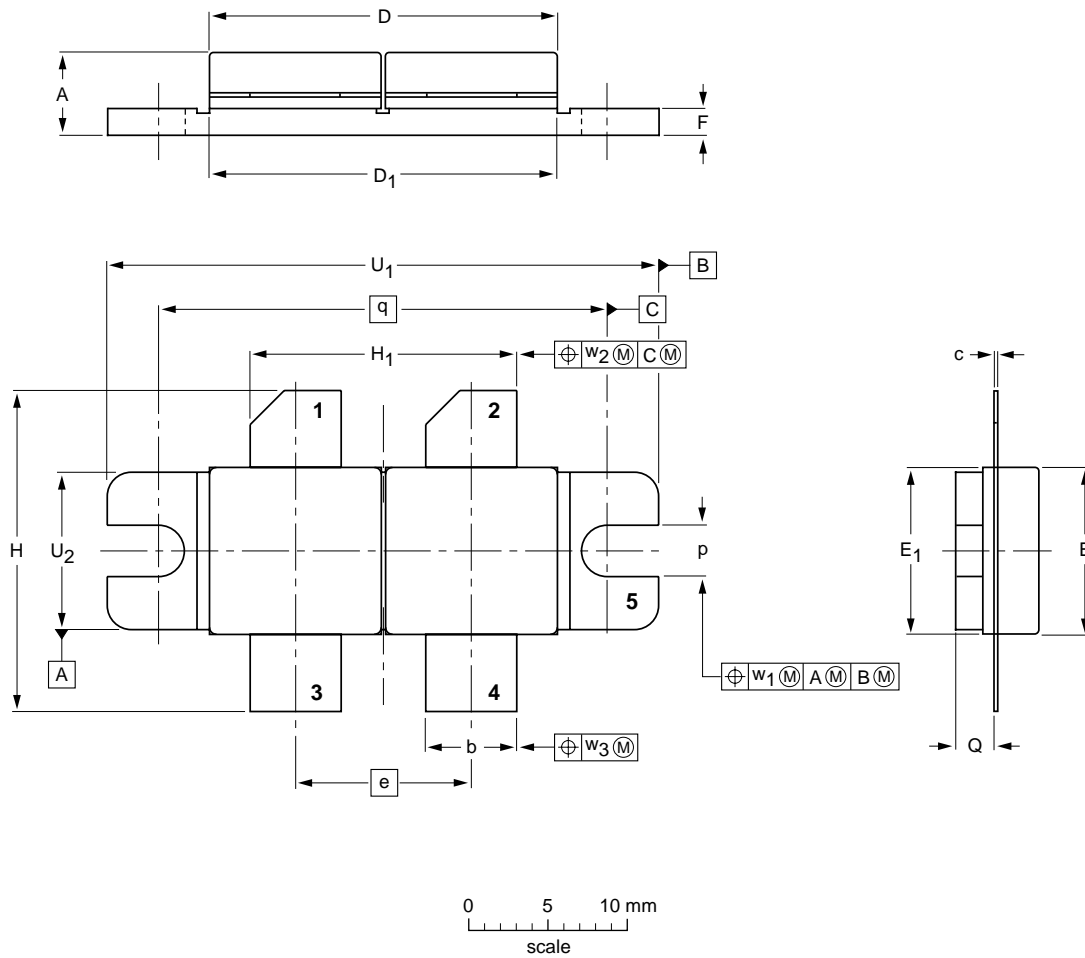

DIMENSIONS (millimetre dimensions are derived from the original inch dimensions)

UNIT	A	b	c	D	D ₁	e	E	E ₁	F	H	H ₁	p	Q	q	U ₁	U ₂	w ₁	w ₂	w ₃
mm	5.39 4.62	5.85 5.58	0.16 0.10	22.17 21.46	21.98 21.71	11.05	10.27 10.05	10.29 10.03	1.78 1.52	21.08 19.56	17.02 16.51	3.28 3.02	2.47 2.20	27.94	34.17 33.90	9.91 9.65	0.25	0.51	0.25
inches	0.212 0.182	0.230 0.220	0.006 0.004	0.873 0.845	0.865 0.855	0.435	0.404 0.396	0.405 0.396	0.070 0.060	0.830 0.770	0.670 0.650	0.129 0.119	0.097 0.087	1.100	1.345 1.335	0.390 0.380	0.010	0.020	0.010

OUTLINE VERSION	REFERENCES				EUROPEAN PROJECTION	ISSUE DATE
	IEC	JEDEC	EIAJ			
SOT262A2						99-03-29

UHF push-pull power MOS transistor

BLF548

DATA SHEET STATUS

LEVEL	DATA SHEET STATUS ⁽¹⁾	PRODUCT STATUS ⁽²⁾⁽³⁾	DEFINITION
I	Objective data	Development	This data sheet contains data from the objective specification for product development. Philips Semiconductors reserves the right to change the specification in any manner without notice.
II	Preliminary data	Qualification	This data sheet contains data from the preliminary specification. Supplementary data will be published at a later date. Philips Semiconductors reserves the right to change the specification without notice, in order to improve the design and supply the best possible product.
III	Product data	Production	This data sheet contains data from the product specification. Philips Semiconductors reserves the right to make changes at any time in order to improve the design, manufacturing and supply. Relevant changes will be communicated via a Customer Product/Process Change Notification (CPCN).

Notes

1. Please consult the most recently issued data sheet before initiating or completing a design.
2. The product status of the device(s) described in this data sheet may have changed since this data sheet was published. The latest information is available on the Internet at URL <http://www.semiconductors.philips.com>.
3. For data sheets describing multiple type numbers, the highest-level product status determines the data sheet status.

DEFINITIONS

Short-form specification — The data in a short-form specification is extracted from a full data sheet with the same type number and title. For detailed information see the relevant data sheet or data handbook.

Limiting values definition — Limiting values given are in accordance with the Absolute Maximum Rating System (IEC 60134). Stress above one or more of the limiting values may cause permanent damage to the device. These are stress ratings only and operation of the device at these or at any other conditions above those given in the Characteristics sections of the specification is not implied. Exposure to limiting values for extended periods may affect device reliability.

Application information — Applications that are described herein for any of these products are for illustrative purposes only. Philips Semiconductors make no representation or warranty that such applications will be suitable for the specified use without further testing or modification.

DISCLAIMERS

Life support applications — These products are not designed for use in life support appliances, devices, or systems where malfunction of these products can reasonably be expected to result in personal injury. Philips Semiconductors customers using or selling these products for use in such applications do so at their own risk and agree to fully indemnify Philips Semiconductors for any damages resulting from such application.

Right to make changes — Philips Semiconductors reserves the right to make changes in the products - including circuits, standard cells, and/or software - described or contained herein in order to improve design and/or performance. When the product is in full production (status 'Production'), relevant changes will be communicated via a Customer Product/Process Change Notification (CPCN). Philips Semiconductors assumes no responsibility or liability for the use of any of these products, conveys no licence or title under any patent, copyright, or mask work right to these products, and makes no representations or warranties that these products are free from patent, copyright, or mask work right infringement, unless otherwise specified.

Philips Semiconductors – a worldwide company

Contact information

For additional information please visit <http://www.semiconductors.philips.com>. Fax: +31 40 27 24825

For sales offices addresses send e-mail to: sales.addresses@www.semiconductors.philips.com.

© Koninklijke Philips Electronics N.V. 2003

SCA75

All rights are reserved. Reproduction in whole or in part is prohibited without the prior written consent of the copyright owner.

The information presented in this document does not form part of any quotation or contract, is believed to be accurate and reliable and may be changed without notice. No liability will be accepted by the publisher for any consequence of its use. Publication thereof does not convey nor imply any license under patent- or other industrial or intellectual property rights.

Printed in The Netherlands

613524/04/pp15

Date of release: 2003 Sep 26

Document order number: 9397 750 11592

Let's make things better.

**Philips
Semiconductors**



PHILIPS

Looking for pricing, stock, or lifecycle information?

Click below to explore more details on WIN SOURCE:

-  [View BLF548,112 on WIN SOURCE](#)
-  [Ampleon USA Inc. Information](#)

Optimize Your Supply Chain with WIN SOURCE Solutions

-  Global Sourcing Solution
-  Obsolete Management
-  Cost Control Management
-  Shortage Management
-  Alternative Solution
-  Excess Inventory Management