



**THE DATASHEET OF
BLF6G27-135,112**



BLF6G27-135; BLF6G27LS-135

WiMAX power LDMOS transistor

Rev. 3 — 1 September 2015

AMPLEON

Product data sheet

1. Product profile

1.1 General description

135 W LDMOS power transistor for base station applications at frequencies from 2500 MHz to 2700 MHz.

Table 1. Typical performance

Typical RF performance at $T_{case} = 25\text{ °C}$ in a class-AB production test circuit.

Mode of operation	f (MHz)	V_{DS} (V)	$P_{L(AV)}$ (W)	$P_{L(p)}$ (W)	G_p (dB)	η_D (%)	ACPR _{885k} (dBc)	ACPR _{1980k} (dBc)
1-carrier N-CDMA ^[1]	2500 to 2700	32	20	200	16	22.5	-52 ^[2]	-67 ^[2]

[1] Single carrier IS-95 with pilot, paging, sync and 6 traffic channels (Walsh codes 8 to 13). PAR = 9.7 dB at 0.01 % probability on the CCDF. Channel bandwidth is 1.2288 MHz.

[2] Measured within 30 kHz bandwidth.

1.2 Features

- Typical 1-carrier N-CDMA performance (Single carrier IS-95 with pilot, paging, sync and 6 traffic channels [Walsh codes 8 to 13]. PAR = 9.7 dB at 0.01 % probability on the CCDF. Channel bandwidth is 1.2288 MHz) at a frequency of 2500 MHz and 2700 MHz, a supply voltage of 32 V and an I_{Dq} of 1200 mA:
 - ◆ Average output power = 20 W
 - ◆ Power gain = 16 dB
 - ◆ Drain efficiency = 22.5 %
 - ◆ ACPR_{885k} = -52.0 dBc in 30 kHz bandwidth
- Easy power control
- Integrated ESD protection
- Excellent ruggedness
- High efficiency
- Excellent thermal stability
- Designed for broadband operation (2500 MHz to 2700 MHz)
- Internally matched for ease of use
- Compliant to Directive 2002/95/EC, regarding Restriction of Hazardous Substances (RoHS)

1.3 Applications

- RF power amplifiers for base stations and multicarrier applications in the 2500 MHz to 2700 MHz frequency range

2. Pinning information

Table 2. Pinning

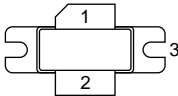
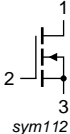
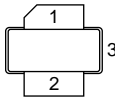
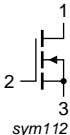
Pin	Description	Simplified outline	Graphic symbol
BLF6G27-135 (SOT502A)			
1	drain		
2	gate		
3	source		
BLF6G27LS-135 (SOT502B)			
1	drain		
2	gate		
3	source		

[1] Connected to flange.

3. Ordering information

Table 3. Ordering information

Type number	Package		
	Name	Description	Version
BLF6G27-135	-	flanged LDMOST ceramic package; 2 mounting holes; 2 leads	SOT502A
BLF6G27LS-135	-	earless flanged LDMOST ceramic package; 2 leads	SOT502B

4. Limiting values

Table 4. Limiting values

In accordance with the Absolute Maximum Rating System (IEC 60134).

Symbol	Parameter	Conditions	Min	Max	Unit
V_{DS}	drain-source voltage		-	65	V
V_{GS}	gate-source voltage		-0.5	+13	V
I_D	drain current		-	34	A
T_{stg}	storage temperature		-65	+150	°C
T_j	junction temperature		-	200	°C

5. Thermal characteristics

Table 5. Thermal characteristics

Symbol	Parameter	Conditions	Type	Typ	Unit
$R_{th(j-case)}$	thermal resistance from junction to case	$T_{case} = 80\text{ °C};$ $P_L = 135\text{ W (CW)}$	BLF6G27-135	0.5	K/W
			BLF6G27LS-135	0.45	K/W

6. Characteristics

Table 6. Characteristics
T_j = 25 °C unless otherwise specified.

Symbol	Parameter	Conditions	Min	Typ	Max	Unit
V _{(BR)DSS}	drain-source breakdown voltage	V _{GS} = 0 V; I _D = 0.5 mA	65	-	-	V
V _{GS(th)}	gate-source threshold voltage	V _{DS} = 10 V; I _D = 216 mA	1.4	2	2.4	V
I _{DSS}	drain leakage current	V _{GS} = 0 V; V _{DS} = 28 V	-	-	4.2	μA
I _{DSX}	drain cut-off current	V _{GS} = V _{GS(th)} + 3.75 V; V _{DS} = 10 V	30.6	34	-	A
I _{GSS}	gate leakage current	V _{GS} = +11 V; V _{DS} = 0 V	-	-	420	nA
g _{fs}	forward transconductance	V _{DS} = 10 V; I _D = 6.3 A	-	12	-	S
R _{DS(on)}	drain-source on-state resistance	V _{GS} = V _{GS(th)} + 3.75 V; I _D = 7.2 A	-	0.085	0.135	Ω
C _{rs}	feedback capacitance	V _{GS} = 0 V; V _{DS} = 28 V; f = 1 MHz	-	3.15	-	pF

7. Application information

Table 7. Application information

Mode of operation: 1-carrier N-CDMA, single carrier IS-95 with pilot, paging, sync and 6 traffic channels (Walsh codes 8 to 13). PAR = 9.7 dB at 0.01 % probability on the CCDF, channel bandwidth is 1.2288 MHz; f₁ = 2500 MHz; f₂ = 2600 MHz; f₃ = 2700 MHz; RF performance at V_{DS} = 32 V; I_{Dq} = 1200 mA; T_{case} = 25 °C; unless otherwise specified, in a class-AB production circuit.

Symbol	Parameter	Conditions	Min	Typ	Max	Unit
G _p	power gain	P _{L(AV)} = 20 W	14	16	-	dB
RL _{in}	input return loss	P _{L(AV)} = 20 W	-	-10	-	dB
η _D	drain efficiency	P _{L(AV)} = 20 W	19.0	22.5	-	%
ACPR _{885k}	adjacent channel power ratio (885 kHz)	P _{L(AV)} = 20 W	[1] -48	-52	-	dBc
ACPR _{1980k}	adjacent channel power ratio (1980 kHz)	P _{L(AV)} = 20 W	[1] -65	-67	-	dBc
P _{L(M)}	peak output power		[2] 185	200	-	W

[1] Measured within 30 kHz bandwidth.

[2] Measured at 2.7 GHz and 3 dB compression of the CCDF at 0.01 % probability.

7.1 Ruggedness in class-AB operation

The BLF6G27-135 and BLF6G27LS-135 are capable of withstanding a load mismatch corresponding to VSWR = 10 : 1 through all phases under the following conditions: V_{DS} = 28 V; I_{Dq} = 1200 mA; P_L = P_{L(1dB)}; f = 2700 MHz.

7.2 Ampleon WiMAX signal

7.2.1 WiMAX signal description

frame duration = 5 ms; bandwidth = 10 MHz; sequency = 1 frame;
 frequency band = WCS; sampling rate = 11.2 MHz; $n = 28 / 25$; $G = T_g / T_b = 1 / 8$;
 FFT = 1024; zone type = PUSC; $\delta = 97.7 \%$; number of symbols = 46;
 number of subchannels = 30; PAR = 9.5 dB.

Preamble: 1 symbol \times 30 subchannels; $P_L = P_{L(nom)} + 3.86$ dB.

Table 8. Frame structure

Frame contents	Modulation technique	Data length
Zone 0 FCH 2 symbols \times 4 subchannels	QPSK1/2	3 bit
Zone 0 data 2 symbols \times 26 subchannels	64QAM3/4	692 bit
Zone 0 data 44 symbols \times 30 subchannels	64QAM3/4	10000 bit

7.2.2 Graphs

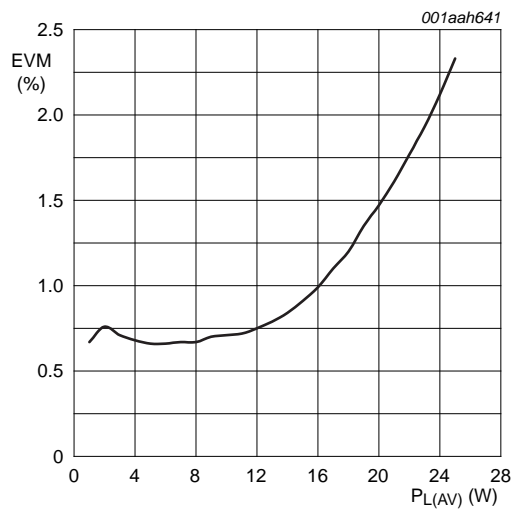

$V_{DS} = 32$ V; $I_{Dq} = 1200$ mA; $f = 2600$ MHz.

Fig 1. EVM as function of average load power; typical values

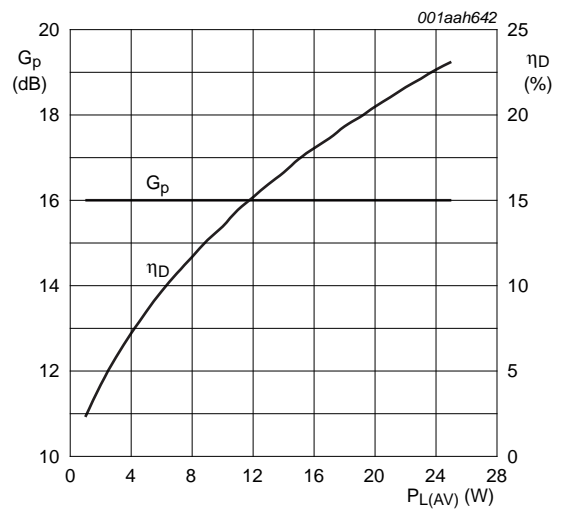

$V_{DS} = 32$ V; $I_{Dq} = 1200$ mA; $f = 2600$ MHz.

Fig 2. Power gain and drain efficiency as functions of average load power; typical values

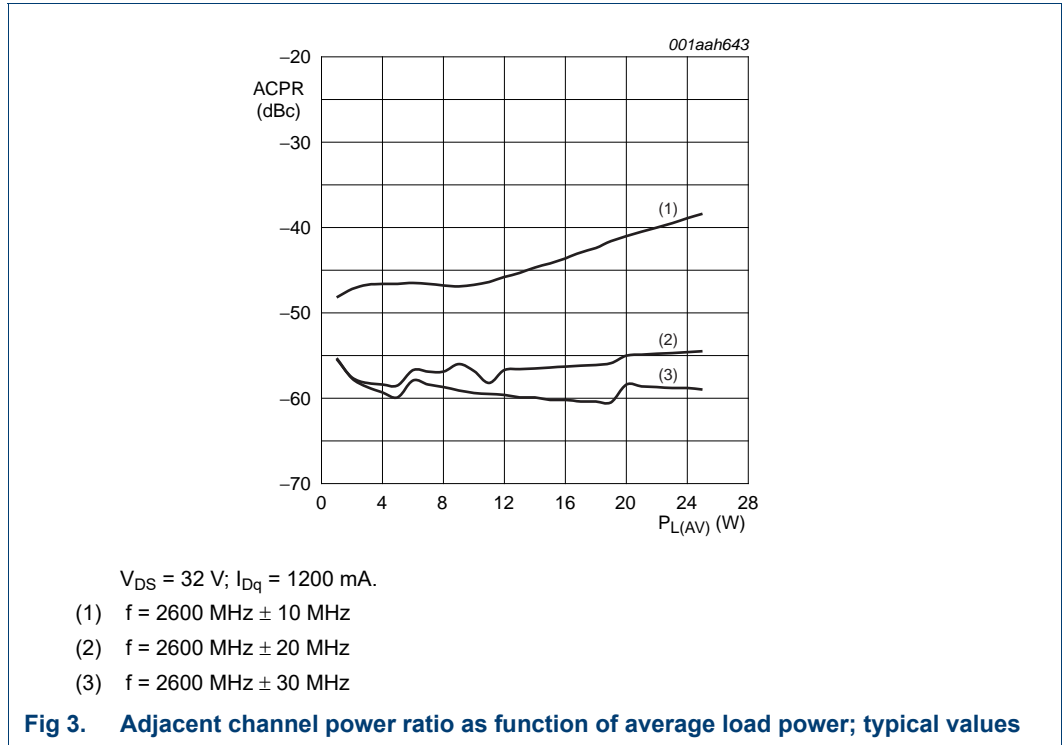

7.3 Single carrier N-CDMA broadband performance at 9 W average

7.3.1 Graphs

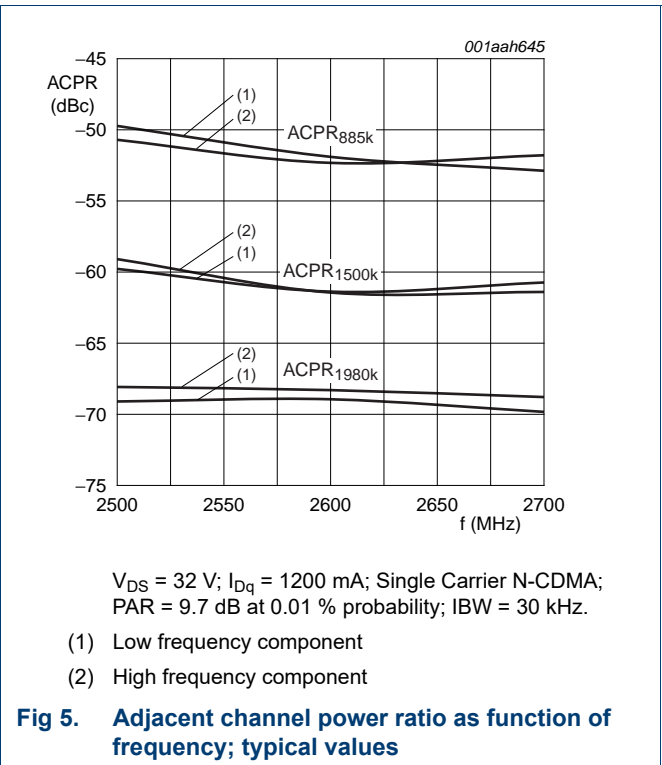
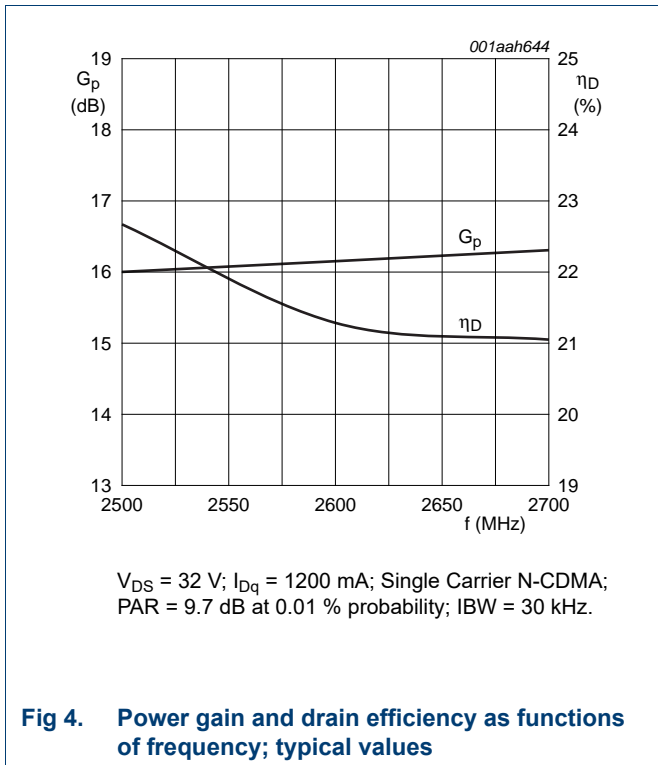

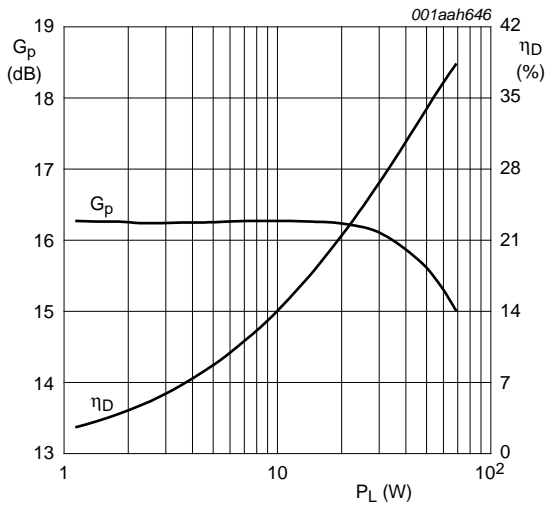

$V_{DS} = 32\text{ V}$; $I_{Dq} = 1200\text{ mA}$; $f = 2600\text{ MHz}$; Single Carrier N-CDMA; PAR = 9.7 dB at 0.01 % probability; Channel Bandwidth = 1.23 MHz; IBW = 30 kHz.

Fig 6. Power gain and drain efficiency as functions of load power; typical values

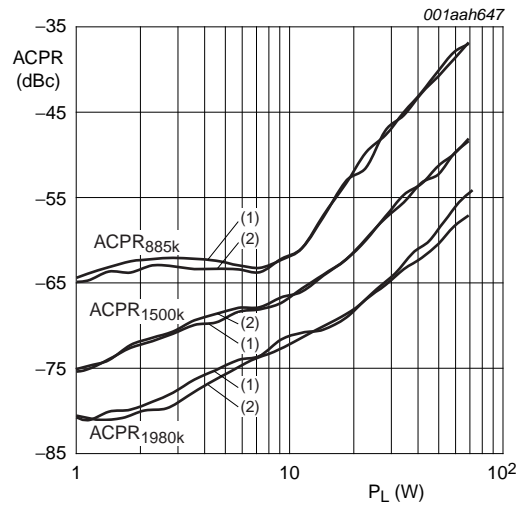

$V_{DS} = 32\text{ V}$; $I_{Dq} = 1200\text{ mA}$; $f = 2600\text{ MHz}$; Single Carrier N-CDMA; PAR = 9.7 dB at 0.01 % probability; Channel Bandwidth = 1.23 MHz; IBW = 30 kHz.

- (1) Low frequency component
- (2) High frequency component

Fig 7. Adjacent channel power ratio as function of load power; typical values

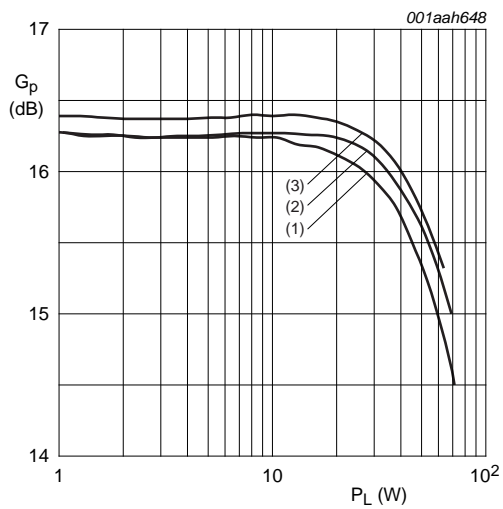

$V_{DS} = 32\text{ V}$; $I_{Dq} = 1200\text{ mA}$; Single Carrier N-CDMA; PAR = 9.7 dB at 0.01 % probability; Channel Bandwidth = 1.23 MHz; IBW = 30 kHz.

- (1) $f = 2500\text{ MHz}$
- (2) $f = 2600\text{ MHz}$
- (3) $f = 2700\text{ MHz}$

Fig 8. Power gain as function of load power; typical values

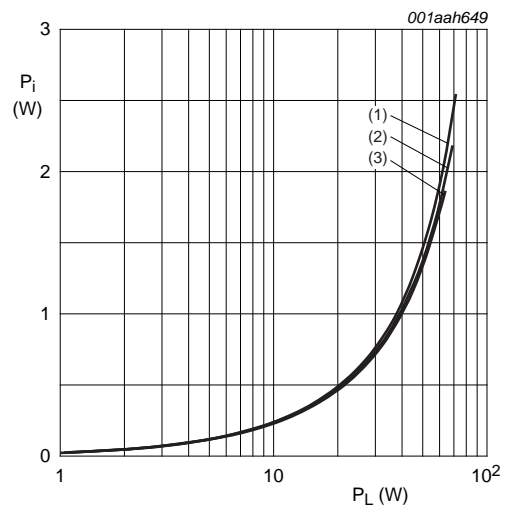

$V_{DS} = 32\text{ V}$; $I_{Dq} = 1200\text{ mA}$; Single Carrier N-CDMA; PAR = 9.7 dB at 0.01 % probability; Channel Bandwidth = 1.23 MHz; IBW = 30 kHz.

- (1) $f = 2500\text{ MHz}$
- (2) $f = 2600\text{ MHz}$
- (3) $f = 2700\text{ MHz}$

Fig 9. Input power as function of load power; typical values

8. Test information

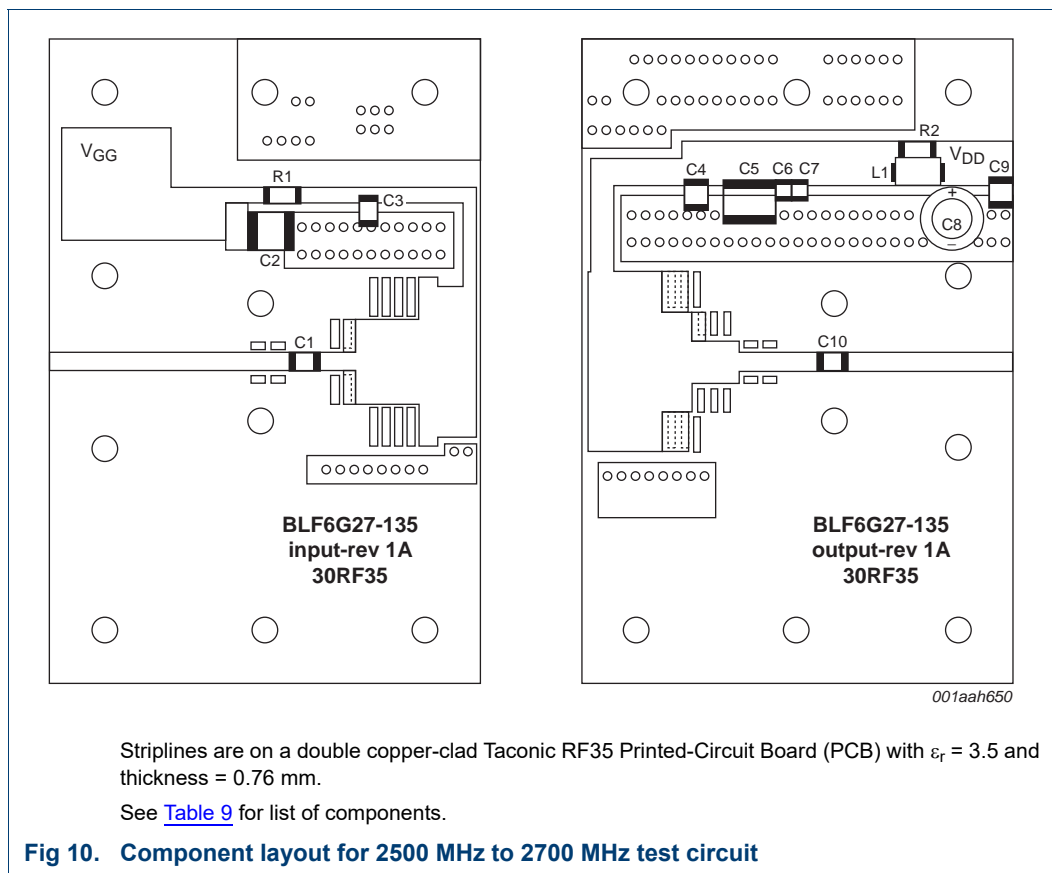

Fig 10. Component layout for 2500 MHz to 2700 MHz test circuit

Table 9. List of components

For test circuit, see Figure 10.

Component	Description	Value	Remarks
C1, C3, C4, C10	multilayer ceramic chip capacitor	8.2 pF	ATC 100B or equivalent
C2	multilayer ceramic chip capacitor	4.7 μF; 50 V	TDK C4532X7R1H475M or equivalent
C5	multilayer ceramic chip capacitor	10 μF; 50 V	TDK C5750X7R1H106M or equivalent
C9	multilayer ceramic chip capacitor	1.5 μF; 50 V	TDK C3225X7R1H155M or equivalent
C6, C7	multilayer ceramic chip capacitor	100 nF	Vishay VJ1206Y104KXB or equivalent
C8	electrolytic capacitor	470 μF; 63 V	ATC 100B or equivalent
L1	ferrite SMD bead	-	Ferroxcube BDS 3/3/4.6-4S2 or equivalent
R1	SMD resistor	5.1 Ω	SMD 1206
R2	SMD resistor	9.1 Ω	SMD 1206

Table 10. Measured test circuit impedances

f (GHz)	Z_i (Ω)	Z_o (Ω)
2.5	1.60 + j1.07	1.44 + j1.86
2.6	1.38 + j2.08	1.17 + j2.80
2.7	1.17 + j2.77	0.97 + j3.41

9. Package outline

Flanged ceramic package; 2 mounting holes; 2 leads

SOT502A

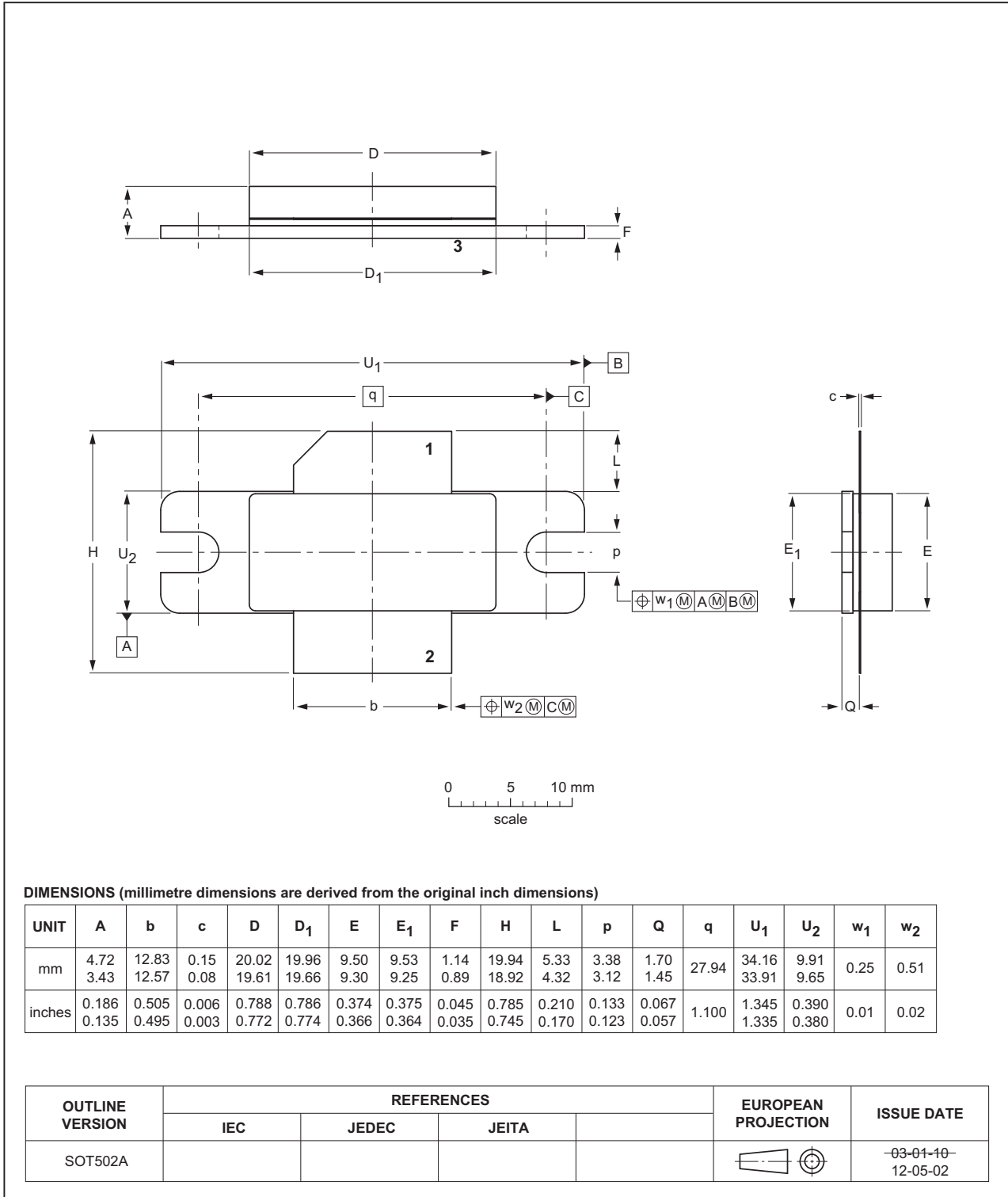

Fig 11. Package outline SOT502A

Earless flanged ceramic package; 2 leads

SOT502B

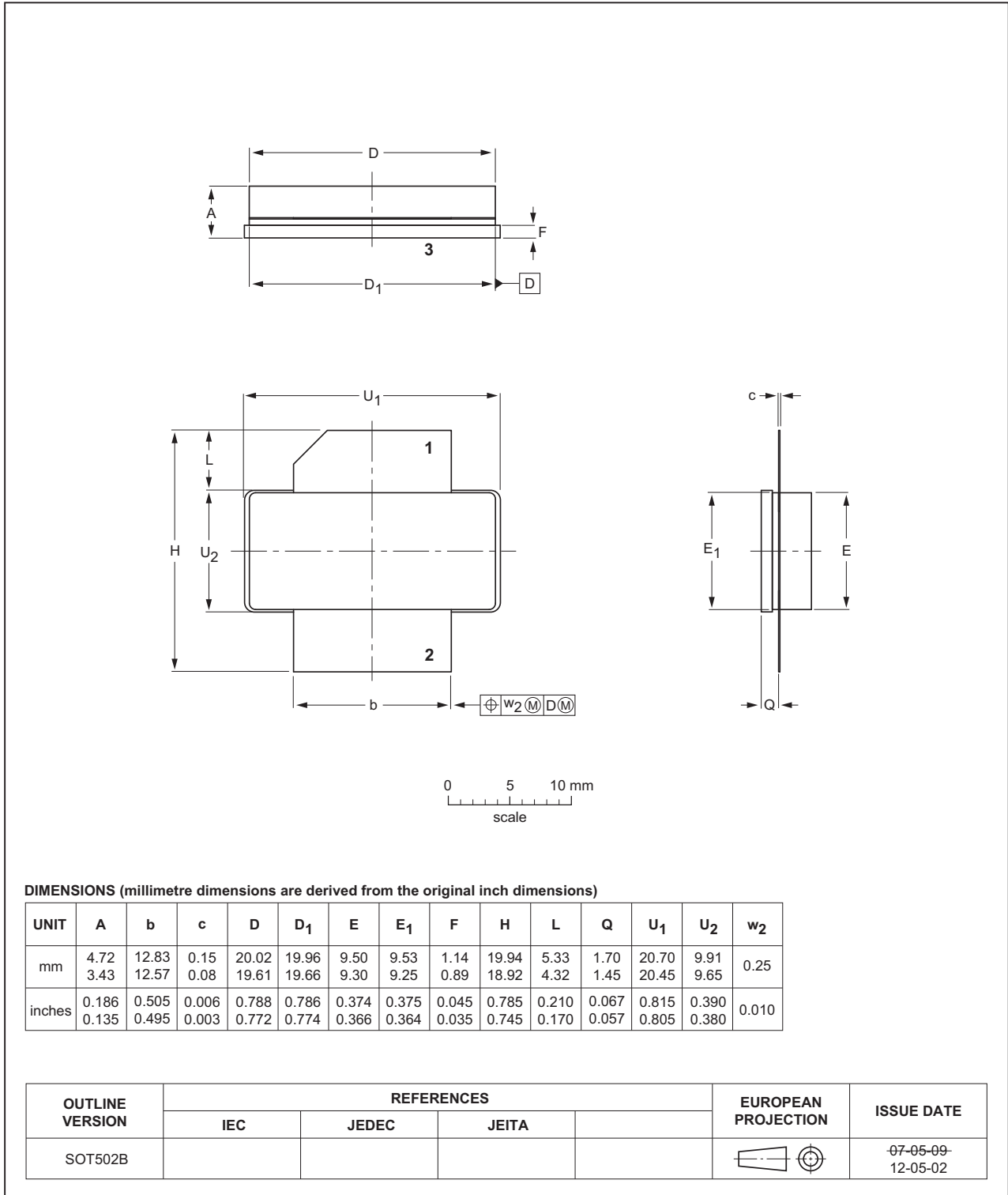

Fig 12. Package outline SOT502B

10. Abbreviations

Table 11. Abbreviations

Acronym	Description
CCDF	Complementary Cumulative Distribution Function
CDMA	Code Division Multiple Access
CW	Continuous Wave
EVM	Error Vector Magnitude
FCH	Frame Control Header
FFT	Fast Fourier Transform
IBW	Instantaneous BandWidth
IS-95	CDMA Interim Standard 95
LDMOS	Laterally Diffused Metal-Oxide Semiconductor
LDMOST	Laterally Diffused Metal-Oxide Semiconductor Transistor
N-CDMA	Narrowband Code Division Multiple Access
PAR	Peak-to-Average power Ratio
PUSC	Partial Usage of SubChannels
RF	Radio Frequency
SMD	Surface Mounted Device
VSWR	Voltage Standing-Wave Ratio
WCS	Wireless Communications Service
WiMAX	Worldwide Interoperability for Microwave Access

11. Revision history

Table 12. Revision history

Document ID	Release date	Data sheet status	Change notice	Supersedes
BLF6G27-135_BLF6G27LS-135#3	20150901	Product data sheet	-	BLF6G27-135_ BLF6G27LS-135_2
Modifications:	<ul style="list-style-type: none"> The format of this document has been redesigned to comply with the new identity guidelines of Ampleon. Legal texts have been adapted to the new company name where appropriate. 			
BLF6G27-135_BLF6G27LS-135_2	20080526	Product data sheet	-	BLF6G27-135_ BLF6G27LS-135_1
BLF6G27-135_BLF6G27LS-135_1	20080221	Preliminary data sheet	-	-

12. Legal information

12.1 Data sheet status

Document status ^{[1][2]}	Product status ^[3]	Definition
Objective [short] data sheet	Development	This document contains data from the objective specification for product development.
Preliminary [short] data sheet	Qualification	This document contains data from the preliminary specification.
Product [short] data sheet	Production	This document contains the product specification.

[1] Please consult the most recently issued document before initiating or completing a design.

[2] The term 'short data sheet' is explained in section "Definitions".

[3] The product status of device(s) described in this document may have changed since this document was published and may differ in case of multiple devices. The latest product status information is available on the Internet at URL <http://www.ampleon.com>.

12.2 Definitions

Draft — The document is a draft version only. The content is still under internal review and subject to formal approval, which may result in modifications or additions. Ampleon does not give any representations or warranties as to the accuracy or completeness of information included herein and shall have no liability for the consequences of use of such information.

Short data sheet — A short data sheet is an extract from a full data sheet with the same product type number(s) and title. A short data sheet is intended for quick reference only and should not be relied upon to contain detailed and full information. For detailed and full information see the relevant full data sheet, which is available on request via the local Ampleon sales office. In case of any inconsistency or conflict with the short data sheet, the full data sheet shall prevail.

Product specification — The information and data provided in a Product data sheet shall define the specification of the product as agreed between Ampleon and its customer, unless Ampleon and customer have explicitly agreed otherwise in writing. In no event however, shall an agreement be valid in which the Ampleon product is deemed to offer functions and qualities beyond those described in the Product data sheet.

12.3 Disclaimers

Limited warranty and liability — Information in this document is believed to be accurate and reliable. However, Ampleon does not give any representations or warranties, expressed or implied, as to the accuracy or completeness of such information and shall have no liability for the consequences of use of such information. Ampleon takes no responsibility for the content in this document if provided by an information source outside of Ampleon.

In no event shall Ampleon be liable for any indirect, incidental, punitive, special or consequential damages (including - without limitation - lost profits, lost savings, business interruption, costs related to the removal or replacement of any products or rework charges) whether or not such damages are based on tort (including negligence), warranty, breach of contract or any other legal theory.

Notwithstanding any damages that customer might incur for any reason whatsoever, Ampleon' aggregate and cumulative liability towards customer for the products described herein shall be limited in accordance with the *Terms and conditions of commercial sale* of Ampleon.

Right to make changes — Ampleon reserves the right to make changes to information published in this document, including without limitation specifications and product descriptions, at any time and without notice. This document supersedes and replaces all information supplied prior to the publication hereof.

Suitability for use — Ampleon products are not designed, authorized or warranted to be suitable for use in life support, life-critical or safety-critical systems or equipment, nor in applications where failure or malfunction of an

Ampleon product can reasonably be expected to result in personal injury, death or severe property or environmental damage. Ampleon and its suppliers accept no liability for inclusion and/or use of Ampleon products in such equipment or applications and therefore such inclusion and/or use is at the customer's own risk.

Applications — Applications that are described herein for any of these products are for illustrative purposes only. Ampleon makes no representation or warranty that such applications will be suitable for the specified use without further testing or modification.

Customers are responsible for the design and operation of their applications and products using Ampleon products, and Ampleon accepts no liability for any assistance with applications or customer product design. It is customer's sole responsibility to determine whether the Ampleon product is suitable and fit for the customer's applications and products planned, as well as for the planned application and use of customer's third party customer(s). Customers should provide appropriate design and operating safeguards to minimize the risks associated with their applications and products.

Ampleon does not accept any liability related to any default, damage, costs or problem which is based on any weakness or default in the customer's applications or products, or the application or use by customer's third party customer(s). Customer is responsible for doing all necessary testing for the customer's applications and products using Ampleon products in order to avoid a default of the applications and the products or of the application or use by customer's third party customer(s). Ampleon does not accept any liability in this respect.

Limiting values — Stress above one or more limiting values (as defined in the Absolute Maximum Ratings System of IEC 60134) will cause permanent damage to the device. Limiting values are stress ratings only and (proper) operation of the device at these or any other conditions above those given in the Recommended operating conditions section (if present) or the Characteristics sections of this document is not warranted. Constant or repeated exposure to limiting values will permanently and irreversibly affect the quality and reliability of the device.

Terms and conditions of commercial sale — Ampleon products are sold subject to the general terms and conditions of commercial sale, as published at <http://www.ampleon.com/terms>, unless otherwise agreed in a valid written individual agreement. In case an individual agreement is concluded only the terms and conditions of the respective agreement shall apply. Ampleon hereby expressly objects to applying the customer's general terms and conditions with regard to the purchase of Ampleon products by customer.

No offer to sell or license — Nothing in this document may be interpreted or construed as an offer to sell products that is open for acceptance or the grant, conveyance or implication of any license under any copyrights, patents or other industrial or intellectual property rights.

Export control — This document as well as the item(s) described herein may be subject to export control regulations. Export might require a prior authorization from competent authorities.

Non-automotive qualified products — Unless this data sheet expressly states that this specific Ampleon product is automotive qualified, the product is not suitable for automotive use. It is neither qualified nor tested in accordance with automotive testing or application requirements. Ampleon accepts no liability for inclusion and/or use of non-automotive qualified products in automotive equipment or applications.

In the event that customer uses the product for design-in and use in automotive applications to automotive specifications and standards, customer (a) shall use the product without Ampleon' warranty of the product for such automotive applications, use and specifications, and (b) whenever customer uses the product for automotive applications beyond Ampleon' specifications such use shall be solely at customer's own risk, and (c) customer fully indemnifies Ampleon for any liability, damages or failed product claims resulting from customer design and use of the product for automotive applications beyond Ampleon' standard warranty and Ampleon' product specifications.

Translations — A non-English (translated) version of a document is for reference only. The English version shall prevail in case of any discrepancy between the translated and English versions.

13. Contact information

For more information, please visit:
<http://www.ampleon.com>

12.4 Trademarks

Notice: All referenced brands, product names, service names and trademarks are the property of their respective owners.

Any reference or use of any 'NXP' trademark in this document or in or on the surface of Ampleon products does not result in any claim, liability or entitlement vis-à-vis the owner of this trademark. Ampleon is no longer part of the NXP group of companies and any reference to or use of the 'NXP' trademarks will be replaced by reference to or use of Ampleon's own Any reference or use of any 'NXP' trademark in this document or in or on the surface of Ampleon products does not result in any claim, liability or entitlement vis-à-vis the owner of this trademark. Ampleon is no longer part of the NXP group of companies and any reference to or use of the 'NXP' trademarks will be replaced by reference to or use of Ampleon's own trademarks.

For sales office addresses, please visit:
<http://www.ampleon.com/sales>

14. Contents

1	Product profile	1
1.1	General description	1
1.2	Features	1
1.3	Applications	1
2	Pinning information	2
3	Ordering information	2
4	Limiting values	2
5	Thermal characteristics	2
6	Characteristics	3
7	Application information	3
7.1	Ruggedness in class-AB operation	3
7.2	Ampleon WiMAX signal	4
7.2.1	WiMAX signal description	4
7.2.2	Graphs	4
7.3	Single carrier N-CDMA broadband performance at 9 W average	5
7.3.1	Graphs	5
8	Test information	7
9	Package outline	9
10	Abbreviations	11
11	Revision history	11
12	Legal information	12
12.1	Data sheet status	12
12.2	Definitions	12
12.3	Disclaimers	12
12.4	Trademarks	13
13	Contact information	13
14	Contents	14

Please be aware that important notices concerning this document and the product(s) described herein, have been included in section 'Legal information'.

© Ampleon The Netherlands B.V. 2015. All rights reserved.

For more information, please visit: <http://www.ampleon.com>
For sales office addresses, please visit: <http://www.ampleon.com/sales>

Date of release: 1 September 2015

Document identifier: BLF6G27-135_BLF6G27LS-135#3

Looking for pricing, stock, or lifecycle information?

Click below to explore more details on WIN SOURCE:

- ⊖ [View BLF6G27-135,112 on WIN SOURCE](#)
- ⊖ [Ampleon USA Inc. Information](#)

Optimize Your Supply Chain with WIN SOURCE Solutions

- ✓ Global Sourcing Solution
- ✓ Obsolete Management
- ✓ Cost Control Management
- ✓ Shortage Management
- ✓ Alternative Solution
- ✓ Excess Inventory Management