



THE DATASHEET OF CDCS502PW



Crystal Oscillator / Clock Generator with optional SSC

FEATURES

- Part of a Family of Easy to use Clock Generator Devices With Optional SSC
- Crystal Oscillator With Integrated Crystal Capacitors, Selectable Output Frequency and Selectable SSC
- SSC Controllable via 2 External Pins
 - $\pm 0\%$, $\pm 0.5\%$, $\pm 1\%$, $\pm 2\%$ Center Spread
- Frequency Multiplication Selectable Between x1 or x4 With one External Control Pin
- Single 3.3V Device Power Supply
- Wide Temperature Range -40°C to 85°C
- Low space Consumption by 8 pin TSSOP Package

APPLICATIONS

- Consumer and Industrial Applications requiring Crystal Oscillator with the possibility of EMI reduction through Spread Spectrum Clocking

PACKAGE

X _{IN}	1	8	X _{OUT}
SSC_SEL 0	2	7	VDD
SSC_SEL 1	3	6	OUT
GND	4	5	FS

BLOCK DIAGRAM

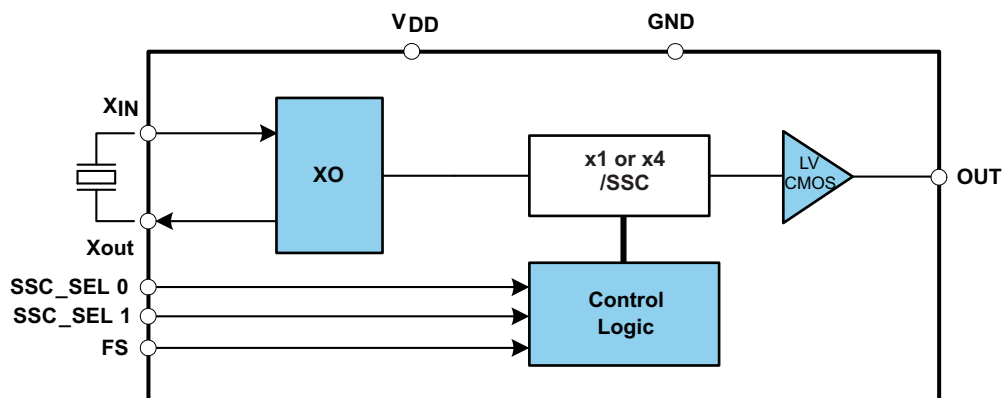

Please be aware that an important notice concerning availability, standard warranty, and use in critical applications of Texas Instruments semiconductor products and disclaimers thereto appears at the end of this data sheet.



These devices have limited built-in ESD protection. The leads should be shorted together or the device placed in conductive foam during storage or handling to prevent electrostatic damage to the MOS gates.

DESCRIPTION

The CDCS502 is a spread spectrum capable, fundamental mode crystal oscillator with selectable frequency multiplication.

It features an advanced gain controlled fundamental mode crystal oscillator stage with a built-in load capacitance of 10pF. This oscillator stage accepts crystals from 8MHz to 32MHz with an ESR of up to 180Ω. The stage can be used with crystals with power dissipation of 50μW and up.

The input signal is processed by a PLL, whose output frequency is either equal to the input frequency or multiplied by the factor of 4.

The PLL is also able to spread the clock signal by ±0%, ±0.5%, ±1% or ±2% centered around the output clock frequency with an triangular modulation.

By this, the device can generate output frequencies between 8MHz and 108MHz with or without SSC from a fundamental mode crystal.

In x1 Mode with an SSC amount of 0%, the device works as a standard crystal oscillator and does not make use of the built in PLL.

The CDCS502 operates in 3.3V environment.

It is characterized for operation from –40°C to 85°C. It is offered in an 8 Pin TSSOP package.

FUNCTION TABLE

FS	SSC_SEL 0	SSC_SEL 1	SSC Amount	f _{OUT} /f _{IN}	f _{OUT} at f _{in} = 27 MHz
0	0	0	±0.00%	1	27 MHz ⁽¹⁾
0	0	1	±0.50%	1	27 MHz
0	1	0	±1.00%	1	27 MHz
0	1	1	±2.00%	1	27 MHz
1	0	0	±0.00%	4	108 MHz
1	0	1	±0.50%	4	108 MHz
1	1	0	±1.00%	4	108 MHz
1	1	1	±2.00%	4	108 MHz

(1) In this mode the signal from the crystal bypasses the internal PLL for maximum performance.

PACKAGE

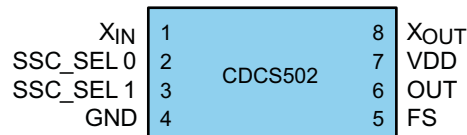

PIN FUNCTIONS

SIGNAL	PIN	TYPE	DESCRIPTION
X _{IN}	1	I	Crystal Input
X _{OUT}	8	O	Crystal Output
OUT	6	O	LVC MOS Clock Output
SSC_SEL 0, 1	2, 3	I	Spread Selection Pins, internal pull-up
FS	5	I	Frequency Multiplication Selection, internal pull-up
V _{DD}	7	Power	3.3V Power Supply
GND	4	Ground	Ground

PACKAGE THERMAL RESISTANCE FOR TSSOP (PW) PACKAGE⁽¹⁾

CDCV304PW 8-PIN TSSOP			THERMAL AIR FLOW (CFM)				UNIT
			0	150	250	500	
R _{θJA}	High K		149	142	138	132	°C/W
R _{θJA}	Low K		230	185	170	150	°C/W
R _{θJC}	High K	65					°C/W
R _{θJC}	High K	69					°C/W

(1) The package thermal impedance is calculated in accordance with JESD 51 and JEDEC2S2P (high-k board).

ABSOLUTE MAXIMUM RATINGS⁽¹⁾

over operating free-air temperature range (unless otherwise noted)

		VALUE	UNIT
V _{DD}	Supply voltage range	-0.5 to 4.6	V
V _{IN}	Input voltage range	-0.5 to 4.6	V
V _{out}	Output voltage range	-0.5 to 4.6	V
I _{IN}	Input current (V _I < 0, V _I > V _{DD})	±20	mA
I _{out}	Continuous output current	±50	mA
T _{ST}	Storage temperature range	-65 to 150	°C
T _J	Maximum junction temperature	125	°C

(1) Stresses beyond those listed under *absolute maximum ratings* may cause permanent damage to the device. These are stress ratings only and functional operation of the device at these or any other conditions beyond those indicated under *recommended operating conditions* is not implied. Exposure to absolute-maximum-rated conditions for extended periods may affect device reliability.

RECOMMENDED OPERATING CONDITIONS

		MIN	NOM	MAX	UNIT
V _{DD}	Supply voltage	3.0		3.6	V
f _{IN}	Input Frequency	8		32	MHz
V _{IL}	Low level input voltage LVCMOS			0.3 V _{DD}	V
V _{IH}	High level input voltage LVCMOS	0.7 V _{DD}			V
V _I	Input Voltage threshold LVCMOS		0.5 V _{DD}		V
C _L	Output Test Load LVCMOS			10	pF
I _{OH} /I _{OL}	Output Current			12	mA
T _A	Operating free-air temperature	-40		85	°C

RECOMMENDED CRYSTAL SPECIFICATIONS⁽¹⁾

PARAMETER	CONDITIONS	MIN	NOM	MAX	UNIT
f _{X-tal}	FS = 0	8		32	MHz
	FS = 1	8		27	
ESR	Effective series resistance ⁽²⁾			180	Ω
C _L	On-chip load capacitance at Xin and Xout		10		pF
T _{X-tal}	Crystal power dissipation	50			μW

(1) For further details on the crystal, see the crystal part in the Applications section

(2) With 5 pF crystal package parallel capacitance

DEVICE CHARACTERISTICS

over operating free-air temperature range (unless otherwise noted)

PARAMETER	CONDITIONS	MIN	TYP	MAX	UNIT	
IDD	Device supply current	f _{out} = 20 MHz; FS = 0, no SSC		8	mA	
		f _{out} = 20 MHz; FS = 0, SSC = 2%		18		
		f _{out} = 70 MHz; FS = 1, SSC = 2%		22		
f _{OUT}	Output frequency	FS = 0		8	32	MHz
		FS = 1		32	108	MHz
I _{IH}	LVC MOS input current	V _I = VDD; VDD = 3.6 V			10	μA
I _{IL}	LVC MOS input current	V _I = 0 V; VDD = 3.6 V			-10	μA
V _{OH}	LVC MOS high-level output voltage	I _{OH} = -0.1 mA		2.9	V	
		I _{OH} = - 8 mA		2.4		
		I _{OH} = -12 mA		2.2		
V _{OL}	LVC MOS low-level output voltage	I _{OL} = 0.1 mA			0.1	V
		I _{OL} = 8 mA			0.5	
		I _{OL} = 12 mA			0.8	
t _{jit(CC)}	Cycle to cycle jitter	f _{out} = 108 MHz; FS = 1, SSC = 1%, 10000 Cycles			100	ps
t _r /t _f	Rise and fall time	20%–80%			0.75	ns
O _{dc}	Output duty cycle	PLL active		45%	55%	
f _{MOD}	Modulation frequency			30		kHz

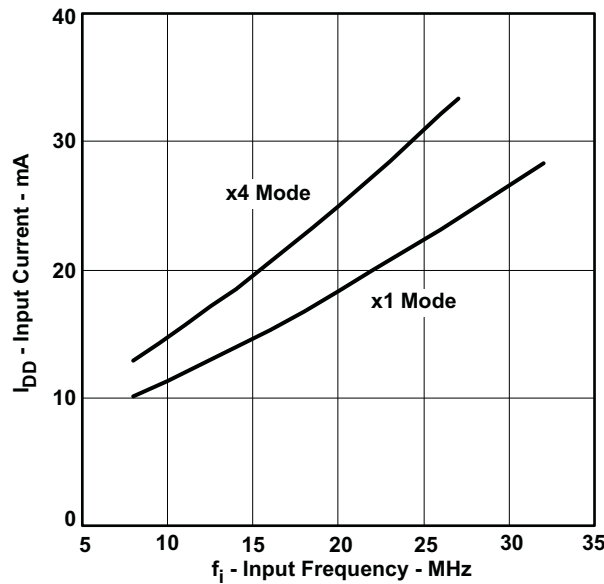

Figure 1. IDD vs Input Frequency, VCC = 3.3V, SSC = 2%

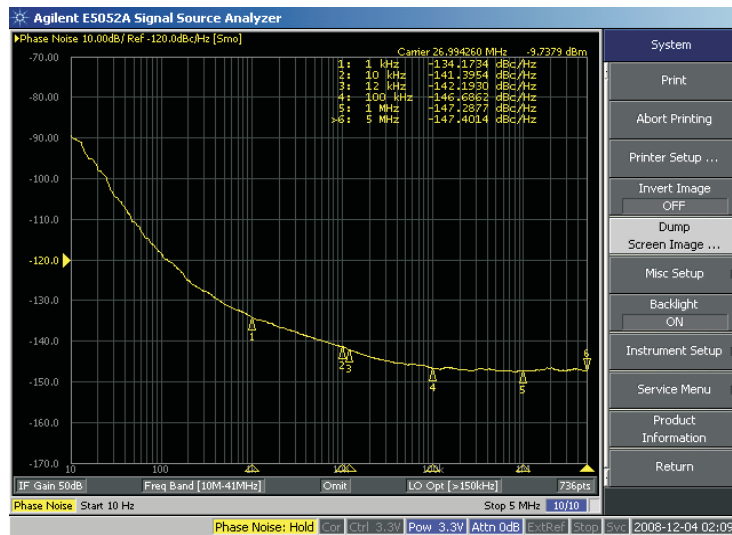

Figure 2. Phase Noise Plot, x1 Mode, 0% SSC, 27 MHz Crystal

APPLICATION INFORMATION

SELECTION OF A CRYSTAL

The CDCS502 requires a crystal with a frequency between 8 and 32 MHz (27MHz in x4 Mode). The crystal stage is designed with an internal load capacitance of 10pF for crystals with this shunt load capacitance. If a slightly bigger capacity than 10pF is needed, small external capacitors can be used to get to this value. This solution however might influence the power-up behavior of the crystal stage, so using a 10pF load capacitance crystal is highly recommended.

For further details on capacitive load calculation, see application report ([SCAA085](#)).

NOTE:

Even though the CDCS502 is characterized down to -40°C , a standard crystal is usually not rated for operation at this low temperature.

SSC MODULATION

The exact implementation of the SSC modulation plays a vital role for the EMI reduction. The CDCS502 uses a triangular modulation scheme implemented in a way that the modulation frequency depends on the VCO frequency of the internal PLL and the spread amount is independent from the VCO frequency.

The modulation frequency can be calculated by using one of the below formulas chosen by frequency multiplication mode.

$$\text{FS} = 0: f_{\text{mod}} = f_{\text{IN}} / 708$$

$$\text{FS} = 1: f_{\text{mod}} = f_{\text{IN}} / 620$$

PARAMETER MEASUREMENT INFORMATION

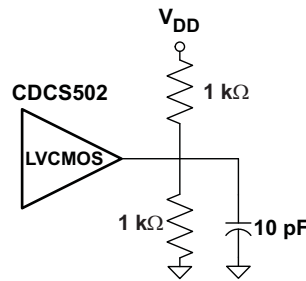

Figure 3. Test Load

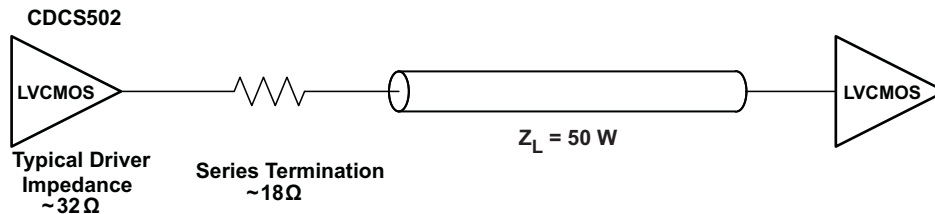

Figure 4. Test Load for 50-Ω Board Environment

PACKAGING INFORMATION

Orderable Device	Status (1)	Package Type	Package Drawing	Pins	Package Qty	Eco Plan (2)	Lead/Ball Finish	MSL Peak Temp (3)	Op Temp (°C)	Top-Side Markings (4)	Samples
CDCS502PW	ACTIVE	TSSOP	PW	8	150	Green (RoHS & no Sb/Br)	CU NIPDAU	Level-1-260C-UNLIM	-40 to 85	CS502	Samples
CDCS502PWR	ACTIVE	TSSOP	PW	8	2000	Green (RoHS & no Sb/Br)	CU NIPDAU	Level-1-260C-UNLIM	-40 to 85	CS502	Samples

(1) The marketing status values are defined as follows:

ACTIVE: Product device recommended for new designs.

LIFEBUY: TI has announced that the device will be discontinued, and a lifetime-buy period is in effect.

NRND: Not recommended for new designs. Device is in production to support existing customers, but TI does not recommend using this part in a new design.

PREVIEW: Device has been announced but is not in production. Samples may or may not be available.

OBSOLETE: TI has discontinued the production of the device.

(2) Eco Plan - The planned eco-friendly classification: Pb-Free (RoHS), Pb-Free (RoHS Exempt), or Green (RoHS & no Sb/Br) - please check <http://www.ti.com/productcontent> for the latest availability information and additional product content details.

TBD: The Pb-Free/Green conversion plan has not been defined.

Pb-Free (RoHS): TI's terms "Lead-Free" or "Pb-Free" mean semiconductor products that are compatible with the current RoHS requirements for all 6 substances, including the requirement that lead not exceed 0.1% by weight in homogeneous materials. Where designed to be soldered at high temperatures, TI Pb-Free products are suitable for use in specified lead-free processes.

Pb-Free (RoHS Exempt): This component has a RoHS exemption for either 1) lead-based flip-chip solder bumps used between the die and package, or 2) lead-based die adhesive used between the die and leadframe. The component is otherwise considered Pb-Free (RoHS compatible) as defined above.

Green (RoHS & no Sb/Br): TI defines "Green" to mean Pb-Free (RoHS compatible), and free of Bromine (Br) and Antimony (Sb) based flame retardants (Br or Sb do not exceed 0.1% by weight in homogeneous material)

(3) MSL, Peak Temp. -- The Moisture Sensitivity Level rating according to the JEDEC industry standard classifications, and peak solder temperature.

(4) Multiple Top-Side Markings will be inside parentheses. Only one Top-Side Marking contained in parentheses and separated by a "~" will appear on a device. If a line is indented then it is a continuation of the previous line and the two combined represent the entire Top-Side Marking for that device.

Important Information and Disclaimer: The information provided on this page represents TI's knowledge and belief as of the date that it is provided. TI bases its knowledge and belief on information provided by third parties, and makes no representation or warranty as to the accuracy of such information. Efforts are underway to better integrate information from third parties. TI has taken and continues to take reasonable steps to provide representative and accurate information but may not have conducted destructive testing or chemical analysis on incoming materials and chemicals. TI and TI suppliers consider certain information to be proprietary, and thus CAS numbers and other limited information may not be available for release.

In no event shall TI's liability arising out of such information exceed the total purchase price of the TI part(s) at issue in this document sold by TI to Customer on an annual basis.

TAPE AND REEL INFORMATION



QUADRANT ASSIGNMENTS FOR PIN 1 ORIENTATION IN TAPE



*All dimensions are nominal

Device	Package Type	Package Drawing	Pins	SPQ	Reel Diameter (mm)	Reel Width W1 (mm)	A0 (mm)	B0 (mm)	K0 (mm)	P1 (mm)	W (mm)	Pin1 Quadrant
CDCS502PWR	TSSOP	PW	8	2000	330.0	12.4	7.0	3.6	1.6	8.0	12.0	Q1

TAPE AND REEL BOX DIMENSIONS



*All dimensions are nominal

Device	Package Type	Package Drawing	Pins	SPQ	Length (mm)	Width (mm)	Height (mm)
CDCS502PWR	TSSOP	PW	8	2000	367.0	367.0	35.0

PW0008A



PACKAGE OUTLINE

TSSOP - 1.2 mm max height

SMALL OUTLINE PACKAGE

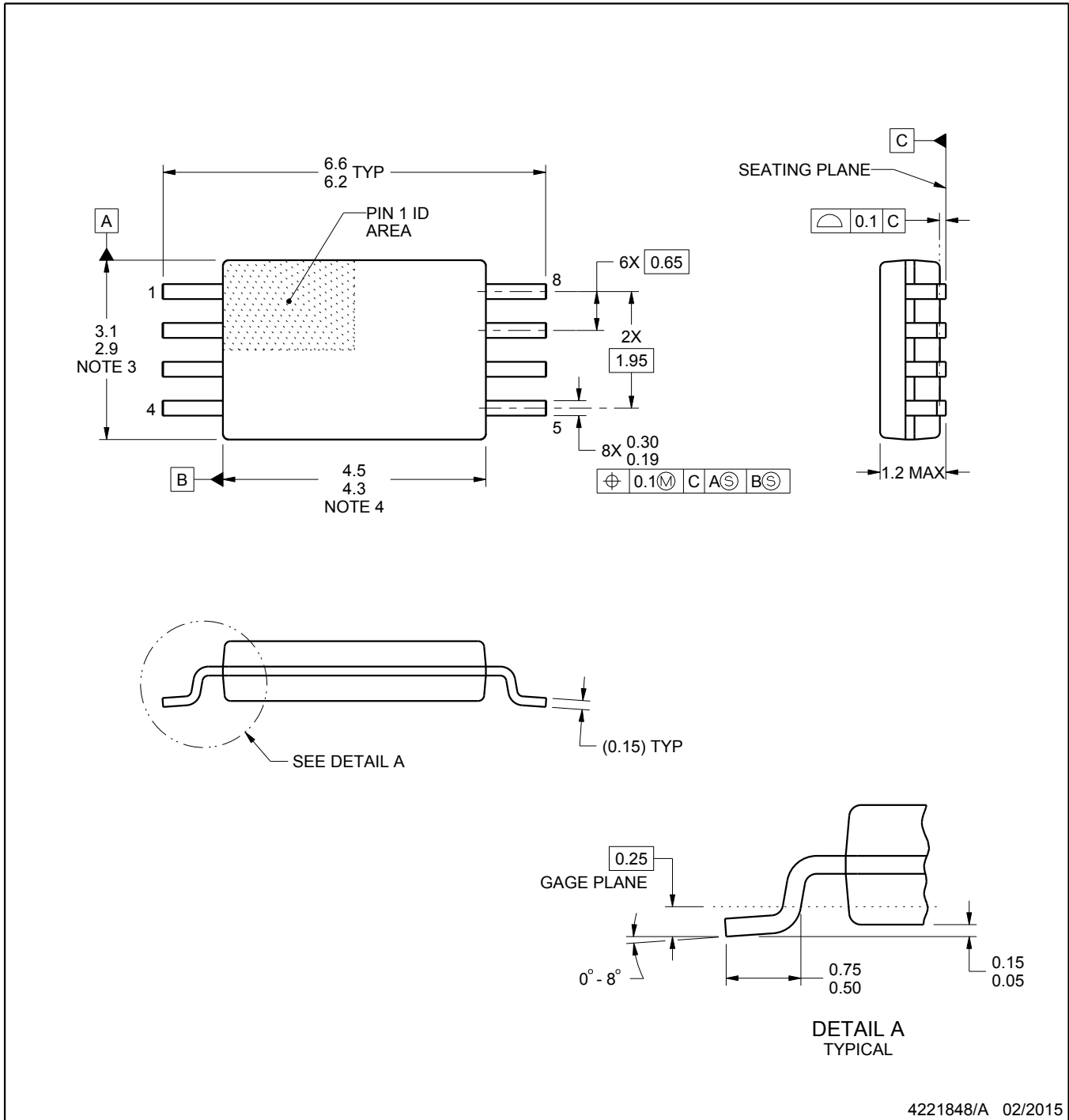

4221848/A 02/2015

NOTES:

1. All linear dimensions are in millimeters. Any dimensions in parenthesis are for reference only. Dimensioning and tolerancing per ASME Y14.5M.
2. This drawing is subject to change without notice.
3. This dimension does not include mold flash, protrusions, or gate burrs. Mold flash, protrusions, or gate burrs shall not exceed 0.15 mm per side.
4. This dimension does not include interlead flash. Interlead flash shall not exceed 0.25 mm per side.
5. Reference JEDEC registration MO-153, variation AA.

EXAMPLE BOARD LAYOUT

PW0008A

TSSOP - 1.2 mm max height

SMALL OUTLINE PACKAGE

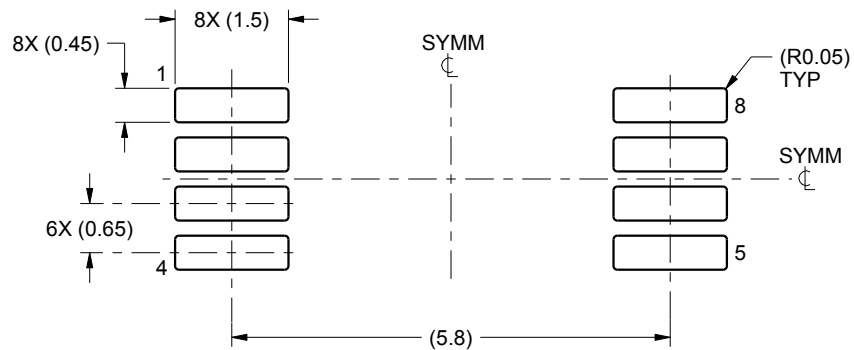

LAND PATTERN EXAMPLE
SCALE:10X

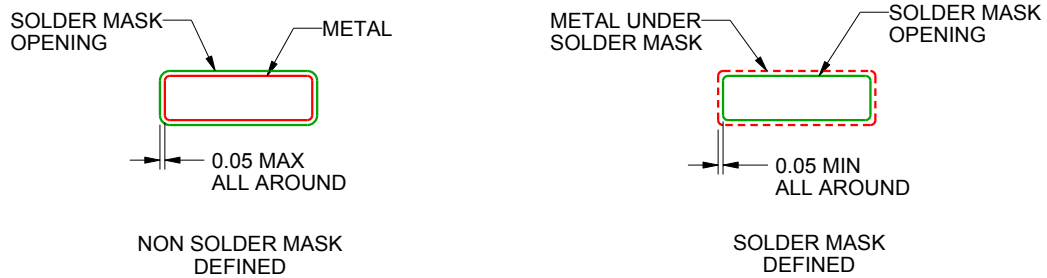

SOLDER MASK DETAILS
NOT TO SCALE

4221848/A 02/2015

NOTES: (continued)

- 6. Publication IPC-7351 may have alternate designs.
- 7. Solder mask tolerances between and around signal pads can vary based on board fabrication site.

EXAMPLE STENCIL DESIGN

PW0008A

TSSOP - 1.2 mm max height

SMALL OUTLINE PACKAGE

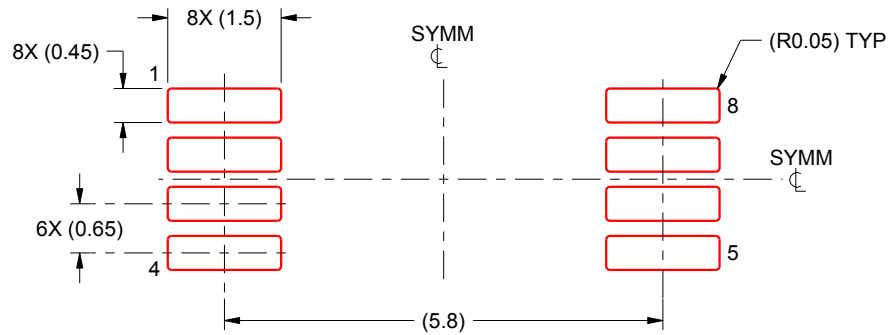

SOLDER PASTE EXAMPLE
BASED ON 0.125 mm THICK STENCIL
SCALE:10X

4221848/A 02/2015

NOTES: (continued)

8. Laser cutting apertures with trapezoidal walls and rounded corners may offer better paste release. IPC-7525 may have alternate design recommendations.
9. Board assembly site may have different recommendations for stencil design.

IMPORTANT NOTICE

Texas Instruments Incorporated and its subsidiaries (TI) reserve the right to make corrections, enhancements, improvements and other changes to its semiconductor products and services per JESD46, latest issue, and to discontinue any product or service per JESD48, latest issue. Buyers should obtain the latest relevant information before placing orders and should verify that such information is current and complete. All semiconductor products (also referred to herein as "components") are sold subject to TI's terms and conditions of sale supplied at the time of order acknowledgment.

TI warrants performance of its components to the specifications applicable at the time of sale, in accordance with the warranty in TI's terms and conditions of sale of semiconductor products. Testing and other quality control techniques are used to the extent TI deems necessary to support this warranty. Except where mandated by applicable law, testing of all parameters of each component is not necessarily performed.

TI assumes no liability for applications assistance or the design of Buyers' products. Buyers are responsible for their products and applications using TI components. To minimize the risks associated with Buyers' products and applications, Buyers should provide adequate design and operating safeguards.

TI does not warrant or represent that any license, either express or implied, is granted under any patent right, copyright, mask work right, or other intellectual property right relating to any combination, machine, or process in which TI components or services are used. Information published by TI regarding third-party products or services does not constitute a license to use such products or services or a warranty or endorsement thereof. Use of such information may require a license from a third party under the patents or other intellectual property of the third party, or a license from TI under the patents or other intellectual property of TI.

Reproduction of significant portions of TI information in TI data books or data sheets is permissible only if reproduction is without alteration and is accompanied by all associated warranties, conditions, limitations, and notices. TI is not responsible or liable for such altered documentation. Information of third parties may be subject to additional restrictions.

Resale of TI components or services with statements different from or beyond the parameters stated by TI for that component or service voids all express and any implied warranties for the associated TI component or service and is an unfair and deceptive business practice. TI is not responsible or liable for any such statements.

Buyer acknowledges and agrees that it is solely responsible for compliance with all legal, regulatory and safety-related requirements concerning its products, and any use of TI components in its applications, notwithstanding any applications-related information or support that may be provided by TI. Buyer represents and agrees that it has all the necessary expertise to create and implement safeguards which anticipate dangerous consequences of failures, monitor failures and their consequences, lessen the likelihood of failures that might cause harm and take appropriate remedial actions. Buyer will fully indemnify TI and its representatives against any damages arising out of the use of any TI components in safety-critical applications.

In some cases, TI components may be promoted specifically to facilitate safety-related applications. With such components, TI's goal is to help enable customers to design and create their own end-product solutions that meet applicable functional safety standards and requirements. Nonetheless, such components are subject to these terms.

No TI components are authorized for use in FDA Class III (or similar life-critical medical equipment) unless authorized officers of the parties have executed a special agreement specifically governing such use.

Only those TI components which TI has specifically designated as military grade or "enhanced plastic" are designed and intended for use in military/aerospace applications or environments. Buyer acknowledges and agrees that any military or aerospace use of TI components which have **not** been so designated is solely at the Buyer's risk, and that Buyer is solely responsible for compliance with all legal and regulatory requirements in connection with such use.

TI has specifically designated certain components as meeting ISO/TS16949 requirements, mainly for automotive use. In any case of use of non-designated products, TI will not be responsible for any failure to meet ISO/TS16949.

Products

Audio	www.ti.com/audio
Amplifiers	amplifier.ti.com
Data Converters	dataconverter.ti.com
DLP® Products	www.dlp.com
DSP	dsp.ti.com
Clocks and Timers	www.ti.com/clocks
Interface	interface.ti.com
Logic	logic.ti.com
Power Mgmt	power.ti.com
Microcontrollers	microcontroller.ti.com
RFID	www.ti-rfid.com
OMAP Applications Processors	www.ti.com/omap
Wireless Connectivity	www.ti.com/wirelessconnectivity

Applications

Automotive and Transportation	www.ti.com/automotive
Communications and Telecom	www.ti.com/communications
Computers and Peripherals	www.ti.com/computers
Consumer Electronics	www.ti.com/consumer-apps
Energy and Lighting	www.ti.com/energy
Industrial	www.ti.com/industrial
Medical	www.ti.com/medical
Security	www.ti.com/security
Space, Avionics and Defense	www.ti.com/space-avionics-defense
Video and Imaging	www.ti.com/video

TI E2E Community

e2e.ti.com

Looking for pricing, stock, or lifecycle information?

Click below to explore more details on WIN SOURCE:

 [View CDCS502PW](#) on WIN SOURCE

 [Texas Instruments](#) Information

Optimize Your Supply Chain with WIN SOURCE Solutions

-  Global Sourcing Solution
-  Obsolete Management
-  Cost Control Management
-  Shortage Management
-  Alternative Solution
-  Excess Inventory Management