



**THE DATASHEET OF
CDRH2D18/HPNP-1R7NC**



SMD Power Inductor CDRH2D18/HP



Halogen Free

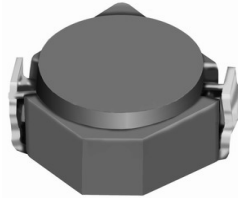

Description

- Ferrite drum core construction.
- Magnetically shielded.
- L × W × H: 3.2 × 3.2 × 2.0 mm Max.
- Product weight: 65mg(Ref.)
- Moisture Sensitivity Level: 1
- RoHS compliance.
- Halogen Free available.

Environmental Data

- Operating temperature range: -40°C~+105°C (including coil's self temperature rise)
- Storage temperature range: -40°C~+105°C
- Solder reflow temperature: 260 °C peak.

Packaging

- Carrier tape and reel packaging
- 7.0" diameter reel
- 1000pcs per reel

Applications

- Ideally used in Mobilephone, PDA, MP3, DSC/DVC, etc. as DC-DC converter inductors.

Dimension - [mm]

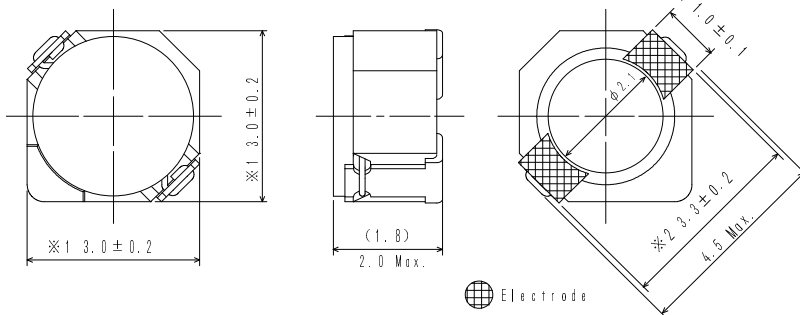

Land pattern and Schematics - [mm]

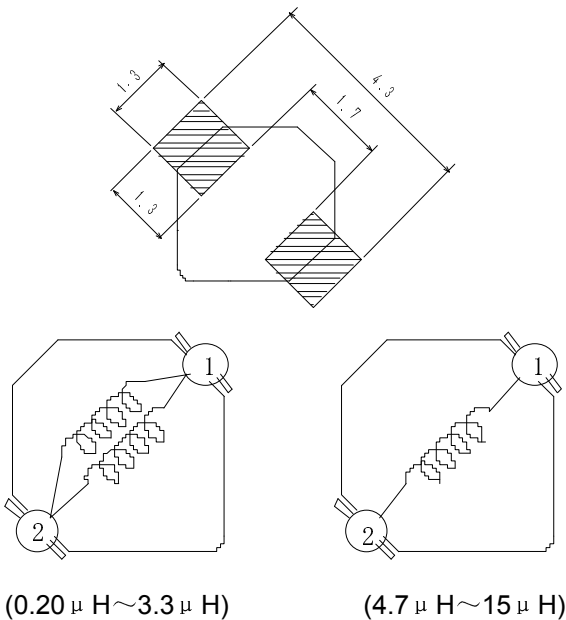

SMD Power Inductor CDRH2D18/HP



Electrical Characteristics

Part Name	Stamp	Inductance (μ H) [within] ※1	D.C.R. (m Ω) Max. (Typ.) (at 20°C)	Saturation Current (A) ※2		Temperature Rise Current (A) ※3
				at 20°C	at 100°C	
CDRH2D18/HPNP-R20NC	N	0.20 \pm 35%	22(17)	5.35	3.55	4.70
CDRH2D18/HPNP-R36NC	P	0.36 \pm 35%	29(22)	4.62	3.00	4.10
CDRH2D18/HPNP-R56NC	Q	0.56 \pm 35%	33(25)	3.75	2.76	3.60
CDRH2D18/HPNP-R82NC	R	0.82 \pm 35%	39(30)	2.91	2.20	3.30
CDRH2D18/HPNP-1R1NC	S	1.10 \pm 35%	43(33)	2.50	1.90	2.90
CDRH2D18/HPNP-1R7NC	A	1.70 \pm 30%	44(35)	1.85	1.36	2.20
CDRH2D18/HPNP-2R2NC	C	2.20 \pm 30%	60(48)	1.60	1.15	1.90
CDRH2D18/HPNP-3R3NC	E	3.30 \pm 30%	86(69)	1.45	1.10	1.55
CDRH2D18/HPNP-4R7NC	G	4.70 \pm 30%	140(110)	1.20	0.90	1.20
CDRH2D18/HPNP-6R3NC	I	6.30 \pm 30%	160(128)	1.05	0.78	1.15
CDRH2D18/HPNP-100NC	K	10.0 \pm 30%	245(195)	0.85	0.65	0.90
CDRH2D18/HPNP-150NC	M	15.0 \pm 30%	345(275)	0.70	0.53	0.64

※1. Inductance measuring condition: 0.20 μ H \sim 1.10 μ H at 7.96MHz ; 1.70 μ H \sim 15.0 μ H at 100kHz

※2. Saturation current: The value of D.C. current when the inductance decreases to 65% of its nominal value.

※3. Temperature rise current: The value of D.C. current when the temperature rise is $\Delta t=40^{\circ}\text{C}$ ($T_a=20^{\circ}\text{C}$).

SMD Power Inductor CDRH2D18/HP



Saturation Current & Temperature Rise Graph

— L (20°C) — L (100°C) — ΔT

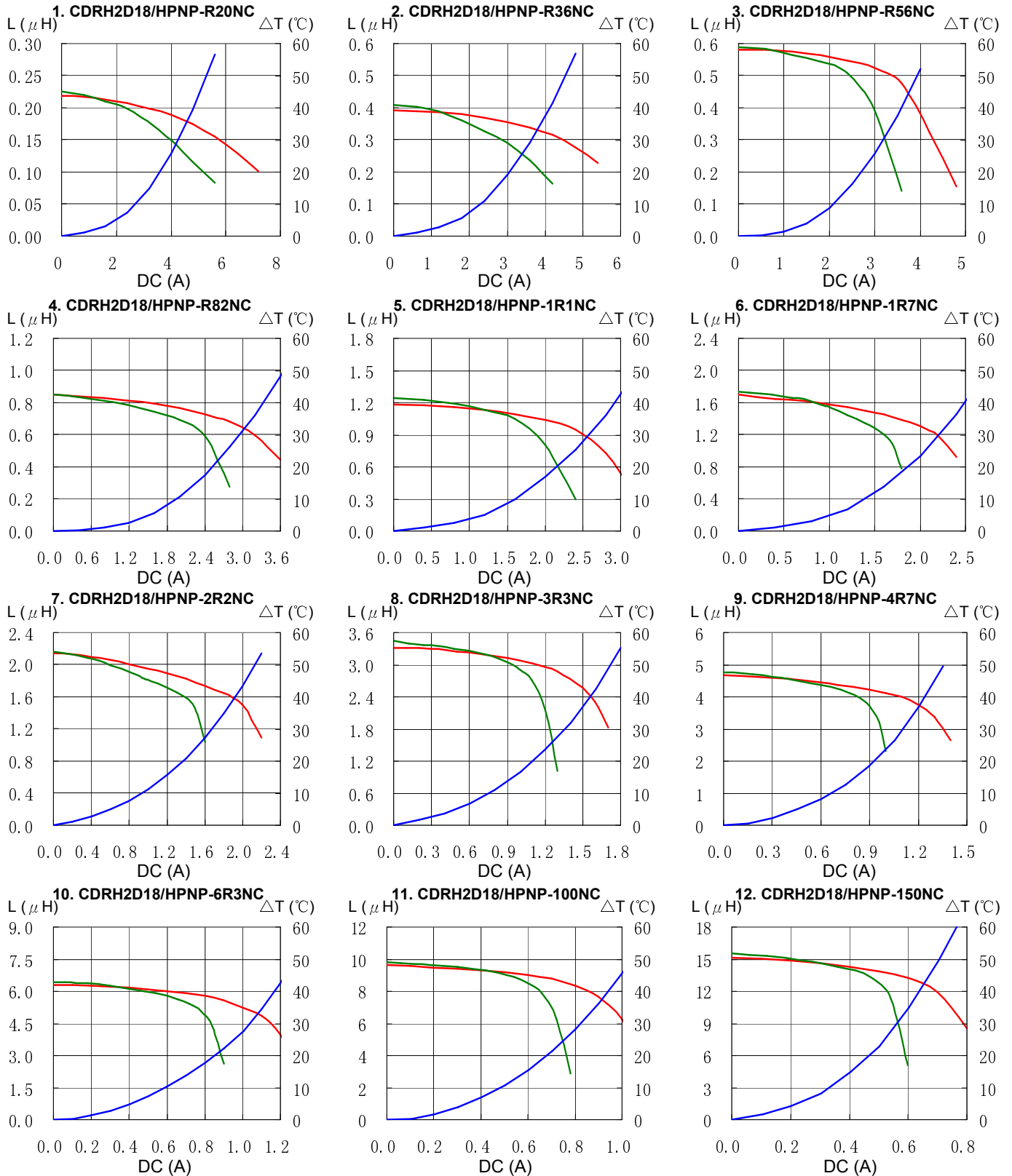

SMD Power Inductor CDRH2D18/HP



Solder Reflow Condition

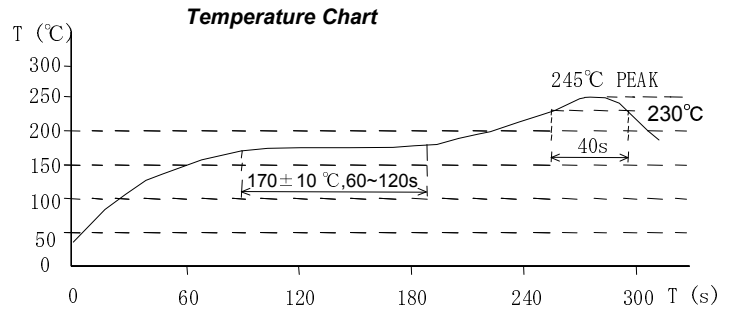
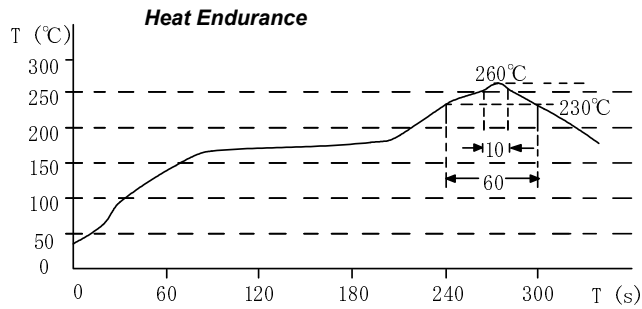

Please refer to the sales offices on our website - <http://www.sumida.com>

Hong Kong

Tel.+852-2880-6781
FAX.+852-2565-9600
sales@hk.sumida.com

Saitama(Japan)

Tel.+81-48-691-7300
FAX.+81-48-691-7340
sales@jp.sumida.com

Chicago

Tel.+1-847-545-6700
FAX. +1-847-545-6720
sales@us.sumida.com

Shanghai

Tel.+86-21-5836-3299
FAX.+86-21-5836-3266
shanghai.sales@cn.sumida.com

Seoul

Tel.+82-2-6237-0777
FAX.+82-2-6237-0778
sales@kr.sumida.com

Oberzell

Tel.+49-8591-937-0
FAX. +49-8591-937-103
contact@eu.sumida.com

Shenzhen

Tel.+86-755-8291-0228
FAX.+86-755-8291-0338
shenzhen.sales@cn.sumida.com

Singapore

Tel.+65-6296-3388
FAX.+65-6841-4426
sales@sg.sumida.com

Neumarkt

Tel.+49-9181-4509-110
FAX. +49-9181-4509-310
infocomp@eu.sumida.com

Taipei

Tel.+886-2-8751-2737
FAX.+886-2-8751-2738
sales@tw.sumida.com

San Jose

Tel.+1-408-321-9660
FAX.+1-408-321-9308
sales@us.sumida.com

Looking for pricing, stock, or lifecycle information?

Click below to explore more details on WIN SOURCE:

- ⊖ [View CDRH2D18/HPNP-1R7NC on WIN SOURCE](#)
- ⊖ [Sumida America Components Inc. Information](#)

Optimize Your Supply Chain with WIN SOURCE Solutions

- ✓ Global Sourcing Solution
- ✓ Obsolete Management
- ✓ Cost Control Management
- ✓ Shortage Management
- ✓ Alternative Solution
- ✓ Excess Inventory Management