



**THE DATASHEET OF
CGH40090PP**



CGH40090PP

90 W, RF Power GaN HEMT

Cree's CGH40090PP is an unmatched, gallium nitride (GaN) high electron mobility transistor (HEMT). The CGH40090PP, operating from a 28 volt rail, offers a general purpose, broadband solution to a variety of RF and microwave applications. GaN HEMTs offer high efficiency, high gain and wide bandwidth capabilities making the CGH40090PP ideal for linear and compressed amplifier circuits. The transistor is available in a 4-lead flange package.

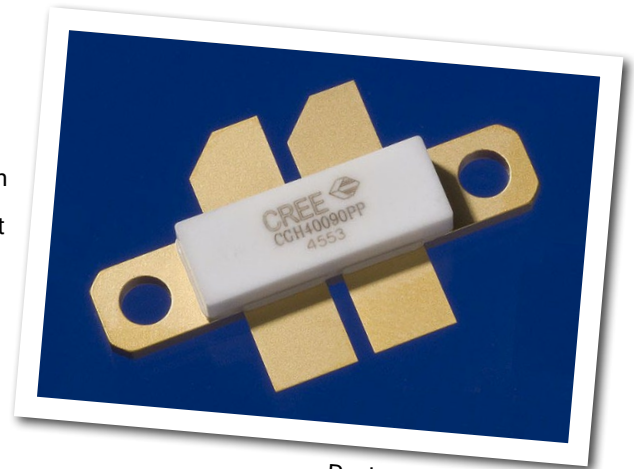

Package Types: 440199
PN: CGH40090PP

Typical Performance Over 500 MHz - 2.5 GHz ($\tau_c = 25^\circ\text{C}$) of Demonstration Amplifier

| Parameter | 500 MHz | 1.0 GHz | 1.5 GHz | 2.0 GHz | 2.5 GHz | Units |
|-------------------------------|---------|---------|---------|---------|---------|-------|
| Small Signal Gain | 17.6 | 15.6 | 14.1 | 12.4 | 12.4 | dB |
| Gain at P_{SAT} | 13.7 | 11.7 | 9.2 | 7.0 | 10.4 | dB |
| Saturated Power | 66.8 | 102.7 | 91.4 | 101.7 | 57.0 | W |
| Drain Efficiency at P_{SAT} | 48.5 | 57.0 | 56.6 | 59.2 | 37.3 | % |
| Input Return Loss | 7.3 | 23.0 | 14.9 | 14.3 | 11.3 | dB |

Features

- Up to 2.5 GHz Operation
- 16 dB Small Signal Gain at 2.0 GHz
- 100 W Typical P_{SAT}
- 55 % Efficiency at P_{SAT}
- 28 V Operation



Large Signal Models Available for ADS and MWO

Absolute Maximum Ratings (not simultaneous) at 25°C Case Temperature

| Parameter | Symbol | Rating | Units | Conditions |
|---|-----------------|-----------|-------|------------|
| Drain-Source Voltage | V_{DSS} | 84 | Volts | 25°C |
| Gate-to-Source Voltage | V_{GS} | -10, +2 | Volts | 25°C |
| Storage Temperature | T_{STG} | -65, +150 | °C | |
| Operating Junction Temperature | T_J | 225 | °C | |
| Maximum Forward Gate Current | I_{GMAX} | 28 | mA | 25°C |
| Maximum Drain Current ¹ | I_{DMAX} | 12 | A | 25°C |
| Soldering Temperature ² | T_S | 245 | °C | |
| Screw Torque | τ | 80 | in-oz | |
| Thermal Resistance, Junction to Case ³ | $R_{\theta JC}$ | 1.45 | °C/W | 85°C |
| Case Operating Temperature ^{3,4} | T_C | -40, +150 | °C | |

Note:

¹ Current limit for long term, reliable operation

² Refer to the Application Note on soldering at www.cree.com/RF/Document-Library

³ Measured for the CGH40090PP at $P_{DISS} = 112W$.

⁴ See also, the Power Dissipation De-rating Curve on Page 6.

Electrical Characteristics ($T_C = 25^\circ C$)

| Characteristics | Symbol | Min. | Typ. | Max. | Units | Conditions |
|---|--------------|------|------|--------|----------|---|
| DC Characteristics¹ | | | | | | |
| Gate Threshold Voltage | $V_{GS(th)}$ | -3.8 | -3.0 | -2.3 | V_{DC} | $V_{DS} = 10 V, I_D = 28.8 mA$ |
| Gate Quiescent Voltage | $V_{GS(Q)}$ | - | -2.7 | - | V_{DC} | $V_{DS} = 28 V, I_D = 1.0 A$ |
| Saturated Drain Current ² | I_{DS} | 23.2 | 28.0 | - | A | $V_{DS} = 6.0 V, V_{GS} = 2.0 V$ |
| Drain-Source Breakdown Voltage | V_{BR} | 120 | - | - | V_{DC} | $V_{GS} = -8 V, I_D = 28.8 mA$ |
| RF Characteristics^{3,4} ($T_C = 25^\circ C, F_0 = 2.0 GHz$ unless otherwise noted) | | | | | | |
| Small Signal Gain | G_{SS} | 12 | 12.5 | - | dB | $V_{DD} = 28 V, I_{DQ} = 1.0 A$ |
| Power Output at Saturation ⁵ | P_{SAT} | 80 | 100 | - | W | $V_{DD} = 28 V, I_{DQ} = 1.0 A$ |
| Drain Efficiency ⁶ | η | 45 | 55 | - | % | $V_{DD} = 28 V, I_{DQ} = 1.0 A, P_{OUT} = P_{SAT}$ |
| Output Mismatch Stress | VSWR | - | - | 10 : 1 | Ψ | No damage at all phase angles, $V_{DD} = 28 V, I_{DQ} = 1.0 A,$ $P_{OUT} = 90 W CW$ |
| Dynamic Characteristics⁷ | | | | | | |
| Input Capacitance | C_{GS} | - | 19.0 | - | pF | $V_{DS} = 28 V, V_{GS} = -8 V, f = 1 MHz$ |
| Output Capacitance | C_{DS} | - | 5.9 | - | pF | $V_{DS} = 28 V, V_{GS} = -8 V, f = 1 MHz$ |
| Feedback Capacitance | C_{GD} | - | 0.8 | - | pF | $V_{DS} = 28 V, V_{GS} = -8 V, f = 1 MHz$ |

Notes:

¹ Measured on wafer prior to packaging.

² Scaled from PCM data.

³ Measured in CGH40090PP-AMP

⁴ I_{DQ} of 1.0 A is by biasing each device at 0.5 A.

⁵ P_{SAT} is defined as: Q1 or Q2 = $I_G = 14 mA$.

⁶ Drain Efficiency = P_{OUT} / P_{DC}

⁷ Capacitance values are for each side of the device.

Typical Performance

**Gain and Efficiency vs Output Power measured in
Broadband Amplifier Circuit CGH40090PP-AMP**
 $V_{DD} = 28\text{ V}$, $I_{DQ} = 1.0\text{ A}$, Freq = 0.5 - 2.5 GHz

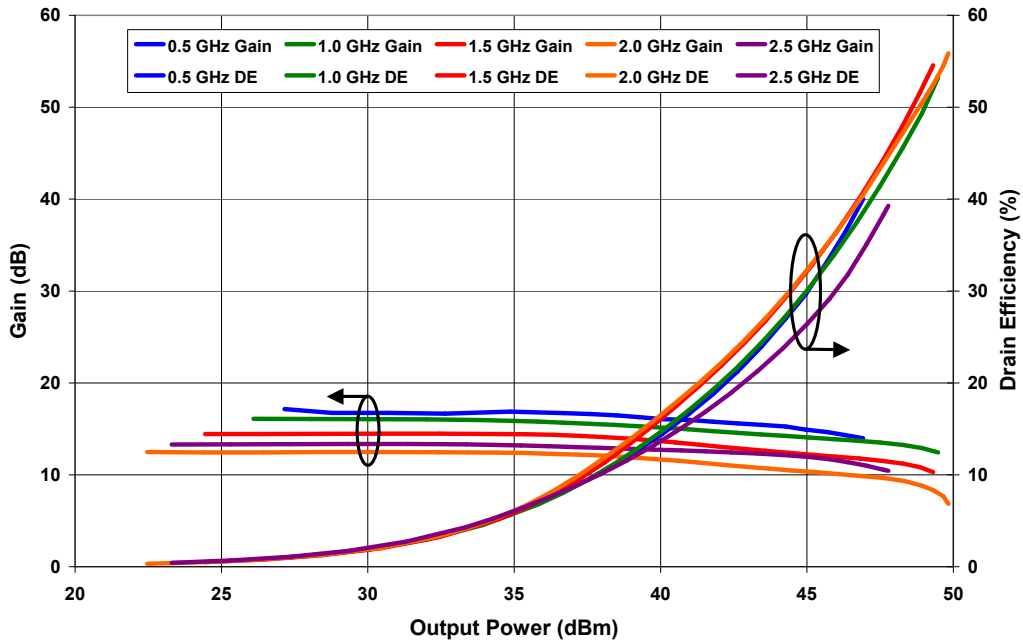

**Output Power and Drain Efficiency vs Frequency
measured in Broadband Amplifier Circuit CGH40090PP-AMP**
 $V_{DD} = 28\text{ V}$, $I_{DQ} = 1.0\text{ A}$

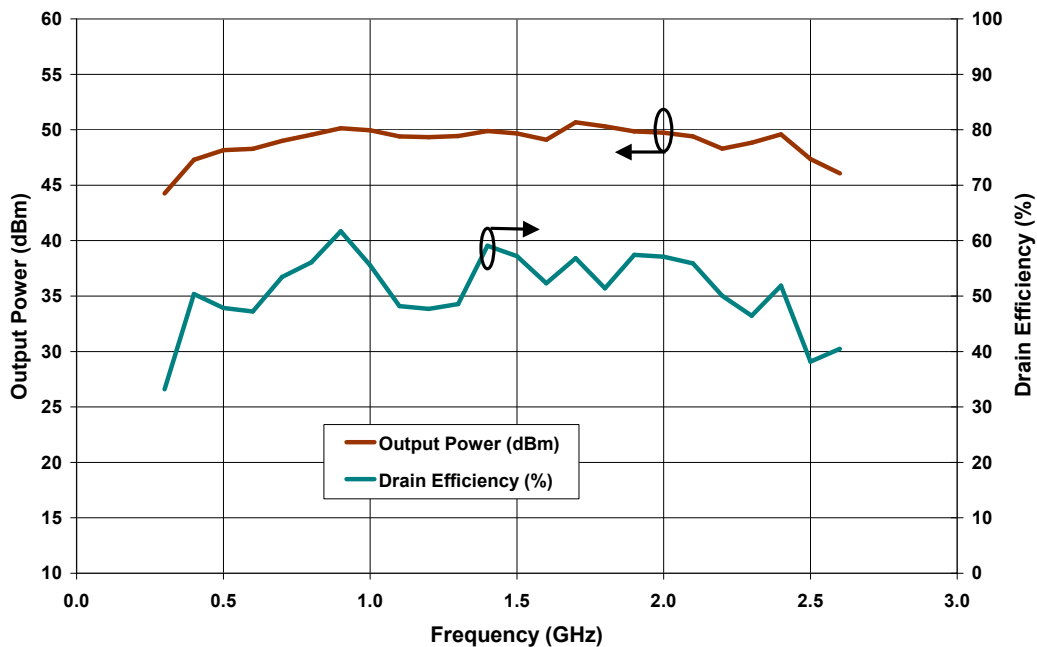

Typical Performance

**Gain and Input Return Loss vs Frequency from 0.5 GHz to 2.5 GHz
in Broadband Amplifier Circuit CGH40090PP-AMP**
 $V_{DD} = 28\text{ V}, I_{DQ} = 1.0\text{ A}$

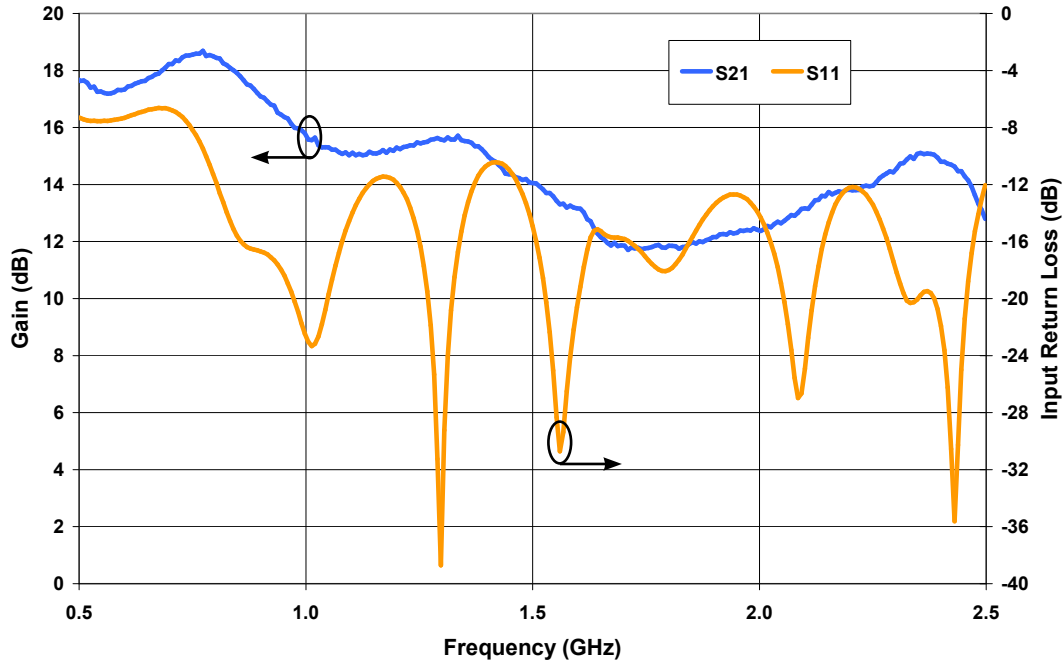

Maximum Available Gain and K Factor of the CGH40090PP
 $V_{DD} = 28\text{ V}, I_{DQ} = 1.0\text{ A}$

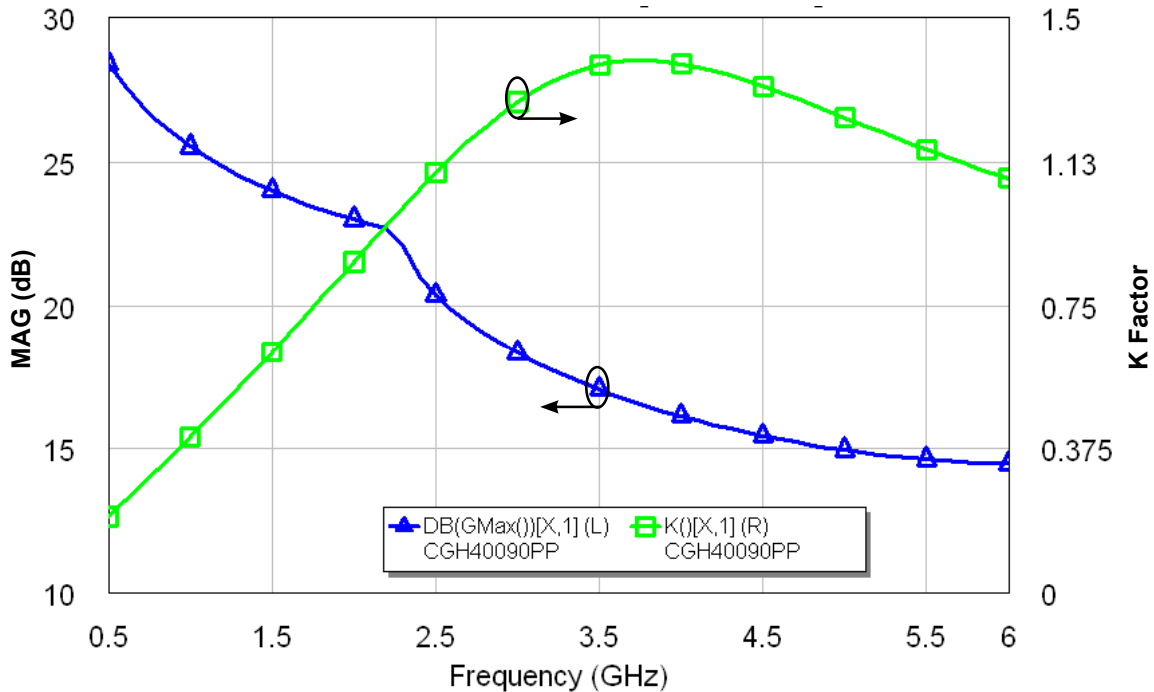

Typical Noise Performance

Simulated Minimum Noise Figure and Noise Resistance vs Frequency of the CGH40090PP
 $V_{DD} = 28\text{ V}$, $I_{DQ} = 500\text{ mA}$ (per side)

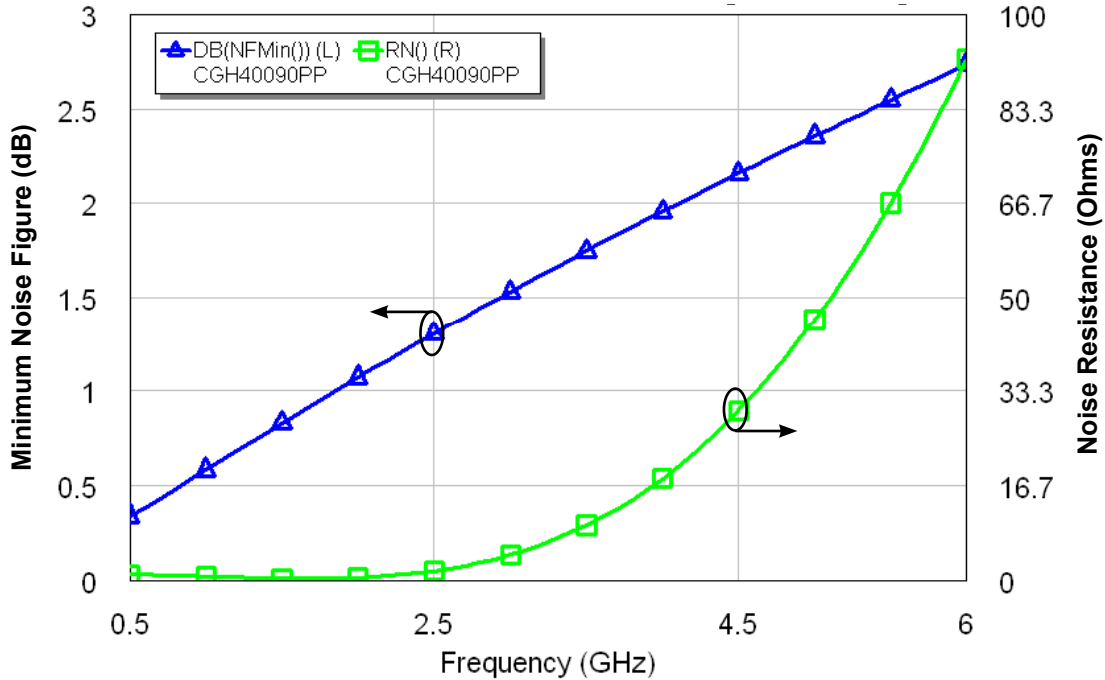

Electrostatic Discharge (ESD) Classifications

| Parameter | Symbol | Class | Test Methodology |
|---------------------|--------|------------|---------------------|
| Human Body Model | HBM | 1A > 250 V | JEDEC JESD22 A114-D |
| Charge Device Model | CDM | 1 < 200 V | JEDEC JESD22 C101-C |

Simulated Source and Load Impedances

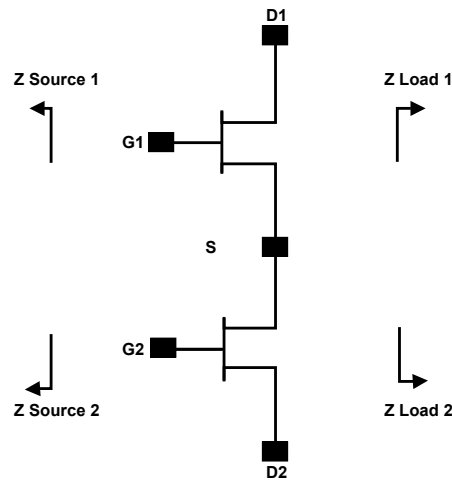

| Frequency (MHz) | Z Source (1,2) | Z Load (1,2) |
|-----------------|----------------|----------------|
| 500 | $4.28 + j6.47$ | $11 + j2.9$ |
| 1500 | $0.95 - j1.1$ | $5.27 + j3$ |
| 2500 | $0.82 - j5.1$ | $3.49 + j0.08$ |

Note 1. $V_{DD} = 28V$, $I_{DQ} = 1.0A$ in the 440199 package.

Note 2. Optimized for power gain, P_{SAT} and PAE.

Note 3. When using this device at low frequency, series resistors should be used to maintain amplifier stability.

CGH40090PP Power Dissipation De-rating Curve

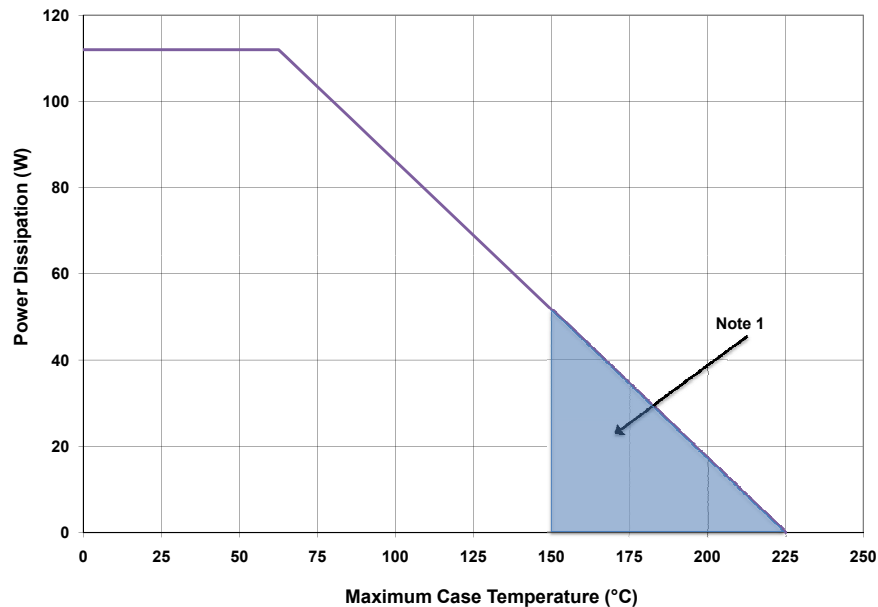

Note 1. Area exceeds Maximum Case Operating Temperature (See Page 2).

CGH40090PP-AMP Demonstration Amplifier Circuit Schematic

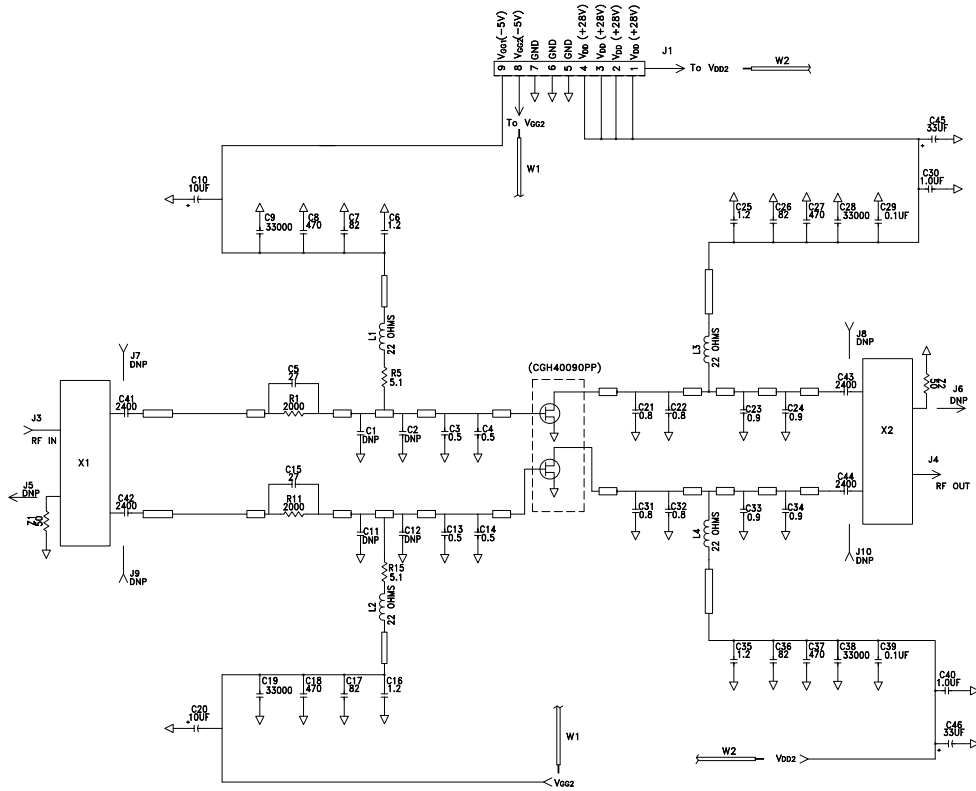

CGH40090PP-AMP Demonstration Amplifier Circuit Outline

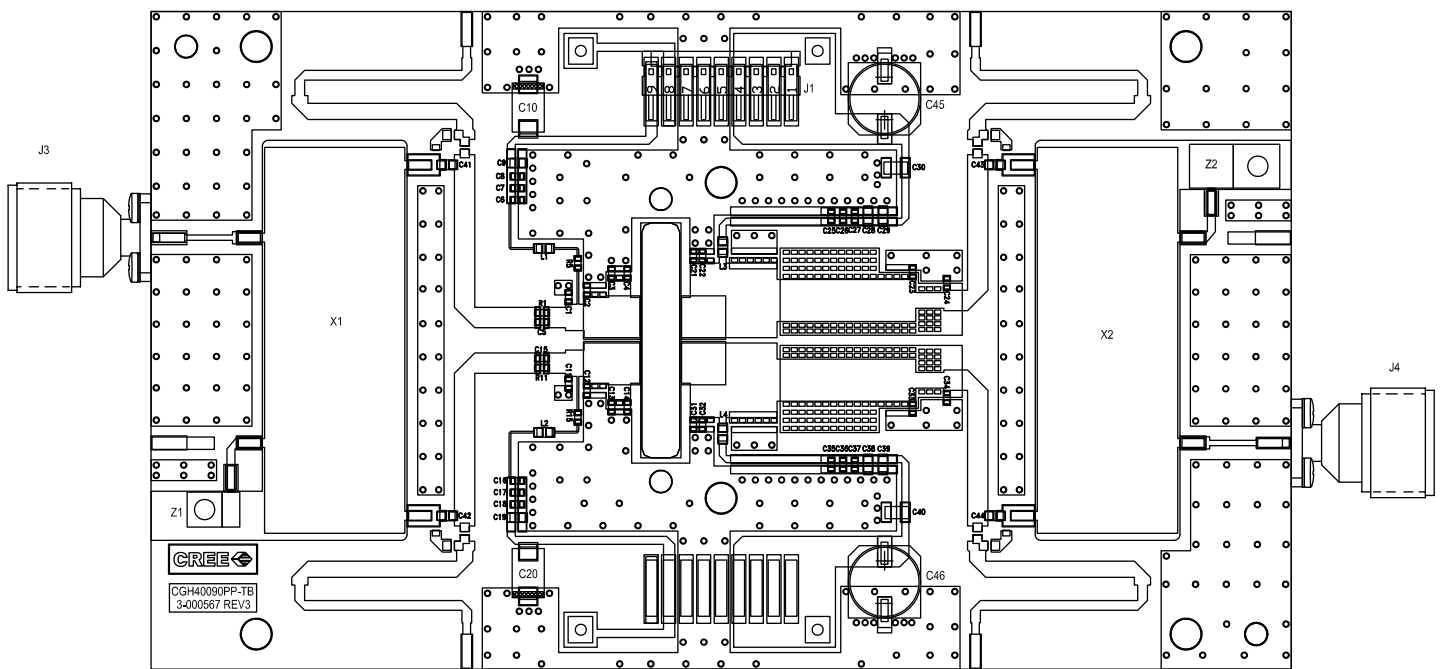

CGH40090PP-AMP Demonstration Amplifier Circuit Bill of Materials

| Designator | Description | Qty |
|--------------------|--|-----|
| C3, C4, C13, C14 | CAP, 0.5 pF, ± 0.05 pF, 0603, ATC 600S | 4 |
| C5, C15 | CAP, 27 pF, $\pm 5\%$, 0603, ATC 600S | 2 |
| C6, C16, C25, C35 | CAP, 1.2 PF ± 0.10 pF, 0603, ATC 600S | 4 |
| C7, C17, C26, C36 | CAP, 82 pF, $\pm 5\%$, 0603, ATC 600S | 4 |
| C8, C18, C27, C37 | CAP, CER, 470 pF, 100V, 10%, X7R, 0603 | 4 |
| C9, C19, C28, C38 | CAP, CER, 33000 pF, 100V, X7R, 0805 | 4 |
| C10, C20 | CAP, TANTALUM, 10UF, 25V, 10%, SMD | 2 |
| C21, C22, C31, C32 | CAP, 0.8 pF, ± 0.1 pF, 0603, ATC 600S | 4 |
| C23, C24, C33, C34 | CAP, 0.9 pF, ± 0.1 pF, 0603, ATC 600S | 4 |
| C29, C39 | CAP, CER, 0.1UF, 50V, 10%, X7R, 0805 | 2 |
| C30, C40 | CAP, 1.0 UF, 100V, 10%, X7R, 1210 | 2 |
| C41, C42, C43, C44 | CAP, DC BLOCK, MULTI-LAYER, 0805, 2400 pF | 4 |
| C45, C46 | CAP, 33 UF, 100V, ELECT, FK, SMD | 2 |
| R1, R11 | RES, 1/16W, 0603, 1%, 2.00K OHMS | 2 |
| R5, R15 | RES, 1/16W, 0603, 1%, 5.1 OHMS | 2 |
| L1, L2, L3, L4 | FERRITE, 22 OHM, 0805, BLM21PG220SN1 | 4 |
| Z1 | 50 OHM, TERMINATION, 30 WATT, HALF FLNG | 1 |
| Z2 | 50 OHM, TERMINATION, 50 WATT, FLANGE | 1 |
| X1, X2 | 1.0 - 2.5 GHZ 50 TO 25 OHM COUPLER, IPP 4011 | 2 |
| J1 | CONN, HEADER, RT>PLZ .1CEN LK 9POS | 1 |
| J3, J4 | CONN, N, FEM, W/.500 SMA FLNG | 2 |
| - | PCB, RO4350B, Er = 3.48, h = 20 mil | 1 |
| Q1 | CGH40090PP | 1 |

CGH40090PP-AMP Demonstration Amplifier Circuit

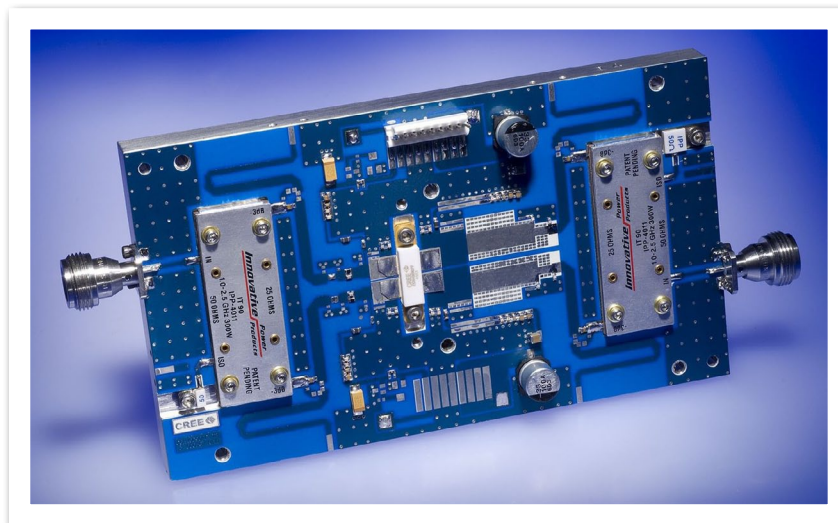

Typical Package S-Parameters for CGH40090PP, Single Side
 (Small Signal, $V_{DS} = 28\text{ V}$, $I_{DQ} = 500\text{ mA}$, angle in degrees)

| Frequency | Mag S11 | Ang S11 | Mag S21 | Ang S21 | Mag S12 | Ang S12 | Mag S22 | Ang S22 |
|-----------|---------|---------|---------|---------|---------|---------|---------|---------|
| 500 MHz | 0.943 | -172.11 | 7.37 | 81.62 | 0.011 | 0.42 | 0.671 | -174.75 |
| 600 MHz | 0.943 | -174.35 | 6.14 | 78.14 | 0.011 | -1.24 | 0.675 | -175.11 |
| 700 MHz | 0.943 | -176.10 | 5.26 | 74.92 | 0.011 | -2.62 | 0.679 | -175.34 |
| 800 MHz | 0.943 | -177.56 | 4.60 | 71.87 | 0.010 | -3.80 | 0.683 | -175.51 |
| 900 MHz | 0.944 | -178.82 | 4.08 | 68.95 | 0.010 | -4.81 | 0.688 | -175.64 |
| 1.0 GHz | 0.944 | -179.94 | 3.67 | 66.12 | 0.010 | -5.69 | 0.693 | -175.76 |
| 1.1 GHz | 0.944 | 179.03 | 3.33 | 63.38 | 0.010 | -6.43 | 0.697 | -175.90 |
| 1.2 GHz | 0.944 | 178.06 | 3.05 | 60.71 | 0.010 | -7.06 | 0.702 | -176.05 |
| 1.3 GHz | 0.945 | 177.15 | 2.82 | 58.09 | 0.010 | -7.58 | 0.707 | -176.22 |
| 1.4 GHz | 0.945 | 176.26 | 2.62 | 55.54 | 0.010 | -7.98 | 0.713 | -176.42 |
| 1.5 GHz | 0.945 | 175.40 | 2.44 | 53.03 | 0.010 | -8.26 | 0.718 | -176.65 |
| 1.6 GHz | 0.945 | 174.56 | 2.29 | 50.57 | 0.010 | -8.43 | 0.723 | -176.92 |
| 1.7 GHz | 0.946 | 173.72 | 2.16 | 48.15 | 0.010 | -8.48 | 0.728 | -177.21 |
| 1.8 GHz | 0.946 | 172.89 | 2.04 | 45.77 | 0.009 | -8.42 | 0.732 | -177.53 |
| 1.9 GHz | 0.946 | 172.05 | 1.94 | 43.43 | 0.009 | -8.24 | 0.737 | -177.88 |
| 2.0 GHz | 0.946 | 171.21 | 1.85 | 41.13 | 0.009 | -7.94 | 0.741 | -178.26 |
| 2.1 GHz | 0.946 | 170.35 | 1.77 | 38.86 | 0.009 | -7.53 | 0.746 | -178.67 |
| 2.2 GHz | 0.945 | 169.49 | 1.70 | 36.61 | 0.009 | -7.02 | 0.750 | -179.11 |
| 2.3 GHz | 0.945 | 168.60 | 1.63 | 34.39 | 0.009 | -6.39 | 0.753 | -179.57 |
| 2.4 GHz | 0.945 | 167.70 | 1.58 | 32.19 | 0.009 | -5.67 | 0.757 | 179.95 |
| 2.5 GHz | 0.945 | 166.78 | 1.52 | 30.01 | 0.009 | -4.86 | 0.760 | 179.44 |
| 2.6 GHz | 0.944 | 165.83 | 1.48 | 27.85 | 0.009 | -3.97 | 0.763 | 178.90 |
| 2.7 GHz | 0.943 | 164.85 | 1.44 | 25.69 | 0.009 | -3.00 | 0.766 | 178.34 |
| 2.8 GHz | 0.943 | 163.83 | 1.40 | 23.55 | 0.009 | -1.98 | 0.768 | 177.76 |
| 2.9 GHz | 0.942 | 162.79 | 1.37 | 21.41 | 0.009 | -0.93 | 0.770 | 177.16 |
| 3.0 GHz | 0.941 | 161.70 | 1.35 | 19.26 | 0.009 | 0.15 | 0.772 | 176.53 |
| 3.2 GHz | 0.938 | 159.38 | 1.31 | 14.96 | 0.010 | 2.31 | 0.774 | 175.21 |
| 3.4 GHz | 0.935 | 156.84 | 1.28 | 10.59 | 0.010 | 4.31 | 0.775 | 173.80 |
| 3.6 GHz | 0.931 | 154.04 | 1.26 | 6.10 | 0.011 | 6.02 | 0.774 | 172.28 |
| 3.8 GHz | 0.926 | 150.90 | 1.26 | 1.46 | 0.012 | 7.28 | 0.772 | 170.66 |
| 4.0 GHz | 0.920 | 147.36 | 1.28 | -3.41 | 0.013 | 7.95 | 0.768 | 168.91 |
| 4.2 GHz | 0.912 | 143.31 | 1.30 | -8.59 | 0.015 | 7.92 | 0.762 | 167.02 |
| 4.4 GHz | 0.902 | 138.62 | 1.35 | -14.16 | 0.017 | 7.08 | 0.754 | 164.97 |
| 4.6 GHz | 0.890 | 133.12 | 1.40 | -20.26 | 0.019 | 5.31 | 0.744 | 162.75 |
| 4.8 GHz | 0.874 | 126.58 | 1.48 | -27.01 | 0.022 | 2.49 | 0.731 | 160.30 |
| 5.0 GHz | 0.854 | 118.69 | 1.58 | -34.60 | 0.026 | -1.53 | 0.714 | 157.61 |
| 5.2 GHz | 0.829 | 109.02 | 1.70 | -43.26 | 0.030 | -6.95 | 0.695 | 154.59 |
| 5.4 GHz | 0.799 | 97.04 | 1.85 | -53.22 | 0.035 | -13.99 | 0.672 | 151.16 |
| 5.6 GHz | 0.765 | 82.06 | 2.01 | -64.77 | 0.041 | -22.88 | 0.645 | 147.15 |
| 5.8 GHz | 0.730 | 63.42 | 2.18 | -78.13 | 0.048 | -33.82 | 0.613 | 142.23 |
| 6.0 GHz | 0.704 | 40.85 | 2.32 | -93.40 | 0.055 | -46.90 | 0.575 | 135.85 |

To download the s-parameters in s2p format, go to the [CGH40090PP Product Page](#) and click on the documentation tab.

Typical Package S-Parameters for CGH40090PP, Single Side
 (Small Signal, $V_{DS} = 28\text{ V}$, $I_{DQ} = 1000\text{ mA}$, angle in degrees)

| Frequency | Mag S11 | Ang S11 | Mag S21 | Ang S21 | Mag S12 | Ang S12 | Mag S22 | Ang S22 |
|-----------|---------|---------|---------|---------|---------|---------|---------|---------|
| 500 MHz | 0.952 | -173.06 | 7.25 | 82.49 | 0.009 | 3.57 | 0.707 | -176.99 |
| 600 MHz | 0.952 | -175.20 | 6.05 | 79.29 | 0.009 | 2.66 | 0.709 | -177.41 |
| 700 MHz | 0.952 | -176.89 | 5.19 | 76.33 | 0.009 | 2.01 | 0.711 | -177.72 |
| 800 MHz | 0.952 | -178.31 | 4.55 | 73.53 | 0.009 | 1.53 | 0.713 | -177.97 |
| 900 MHz | 0.952 | -179.54 | 4.05 | 70.83 | 0.009 | 1.20 | 0.716 | -178.19 |
| 1.0 GHz | 0.952 | 179.35 | 3.65 | 68.21 | 0.009 | 0.99 | 0.718 | -178.39 |
| 1.1 GHz | 0.952 | 178.33 | 3.32 | 65.65 | 0.008 | 0.88 | 0.721 | -178.59 |
| 1.2 GHz | 0.952 | 177.37 | 3.05 | 63.15 | 0.008 | 0.87 | 0.724 | -178.80 |
| 1.3 GHz | 0.952 | 176.46 | 2.82 | 60.70 | 0.008 | 0.95 | 0.727 | -179.02 |
| 1.4 GHz | 0.952 | 175.58 | 2.63 | 58.28 | 0.008 | 1.11 | 0.729 | -179.25 |
| 1.5 GHz | 0.952 | 174.72 | 2.46 | 55.90 | 0.008 | 1.37 | 0.732 | -179.50 |
| 1.6 GHz | 0.951 | 173.87 | 2.32 | 53.56 | 0.008 | 1.70 | 0.735 | -179.77 |
| 1.7 GHz | 0.951 | 173.03 | 2.19 | 51.24 | 0.008 | 2.12 | 0.738 | 179.94 |
| 1.8 GHz | 0.951 | 172.19 | 2.08 | 48.95 | 0.008 | 2.61 | 0.741 | 179.63 |
| 1.9 GHz | 0.951 | 171.35 | 1.98 | 46.68 | 0.008 | 3.17 | 0.743 | 179.30 |
| 2.0 GHz | 0.950 | 170.50 | 1.89 | 44.44 | 0.008 | 3.80 | 0.746 | 178.95 |
| 2.1 GHz | 0.950 | 169.64 | 1.82 | 42.22 | 0.009 | 4.48 | 0.748 | 178.57 |
| 2.2 GHz | 0.950 | 168.77 | 1.75 | 40.01 | 0.009 | 5.21 | 0.750 | 178.17 |
| 2.3 GHz | 0.949 | 167.89 | 1.69 | 37.82 | 0.009 | 5.99 | 0.752 | 177.75 |
| 2.4 GHz | 0.948 | 166.98 | 1.63 | 35.63 | 0.009 | 6.79 | 0.754 | 177.31 |
| 2.5 GHz | 0.948 | 166.05 | 1.59 | 33.46 | 0.009 | 7.62 | 0.756 | 176.85 |
| 2.6 GHz | 0.947 | 165.09 | 1.54 | 31.29 | 0.009 | 8.45 | 0.757 | 176.36 |
| 2.7 GHz | 0.946 | 164.10 | 1.51 | 29.13 | 0.009 | 9.28 | 0.758 | 175.85 |
| 2.8 GHz | 0.945 | 163.08 | 1.47 | 26.96 | 0.009 | 10.09 | 0.759 | 175.32 |
| 2.9 GHz | 0.944 | 162.02 | 1.44 | 24.80 | 0.010 | 10.87 | 0.760 | 174.77 |
| 3.0 GHz | 0.943 | 160.92 | 1.42 | 22.62 | 0.010 | 11.60 | 0.760 | 174.19 |
| 3.2 GHz | 0.940 | 158.58 | 1.38 | 18.22 | 0.011 | 12.89 | 0.760 | 172.97 |
| 3.4 GHz | 0.936 | 156.01 | 1.36 | 13.73 | 0.011 | 13.85 | 0.759 | 171.64 |
| 3.6 GHz | 0.931 | 153.17 | 1.35 | 9.11 | 0.013 | 14.40 | 0.756 | 170.22 |
| 3.8 GHz | 0.926 | 149.99 | 1.36 | 4.29 | 0.014 | 14.44 | 0.752 | 168.68 |
| 4.0 GHz | 0.919 | 146.39 | 1.37 | -0.77 | 0.015 | 13.91 | 0.745 | 167.02 |
| 4.2 GHz | 0.910 | 142.27 | 1.41 | -6.16 | 0.017 | 12.71 | 0.737 | 165.22 |
| 4.4 GHz | 0.899 | 137.51 | 1.46 | -11.97 | 0.019 | 10.77 | 0.727 | 163.26 |
| 4.6 GHz | 0.885 | 131.91 | 1.52 | -18.32 | 0.022 | 7.99 | 0.714 | 161.14 |
| 4.8 GHz | 0.868 | 125.25 | 1.61 | -25.36 | 0.025 | 4.22 | 0.698 | 158.82 |
| 5.0 GHz | 0.846 | 117.21 | 1.72 | -33.26 | 0.029 | -0.67 | 0.679 | 156.28 |
| 5.2 GHz | 0.820 | 107.37 | 1.85 | -42.24 | 0.034 | -6.89 | 0.656 | 153.46 |
| 5.4 GHz | 0.788 | 95.18 | 2.00 | -52.53 | 0.040 | -14.64 | 0.630 | 150.27 |
| 5.6 GHz | 0.752 | 79.98 | 2.17 | -64.39 | 0.046 | -24.17 | 0.601 | 146.53 |
| 5.8 GHz | 0.717 | 61.12 | 2.33 | -78.01 | 0.053 | -35.65 | 0.567 | 141.88 |
| 6.0 GHz | 0.692 | 38.42 | 2.48 | -93.47 | 0.060 | -49.14 | 0.527 | 135.72 |

To download the s-parameters in s2p format, go to the [CGH40090PP Product Page](#) and click on the documentation tab.

Product Dimensions CGH40090PP (Package Type – 440199)

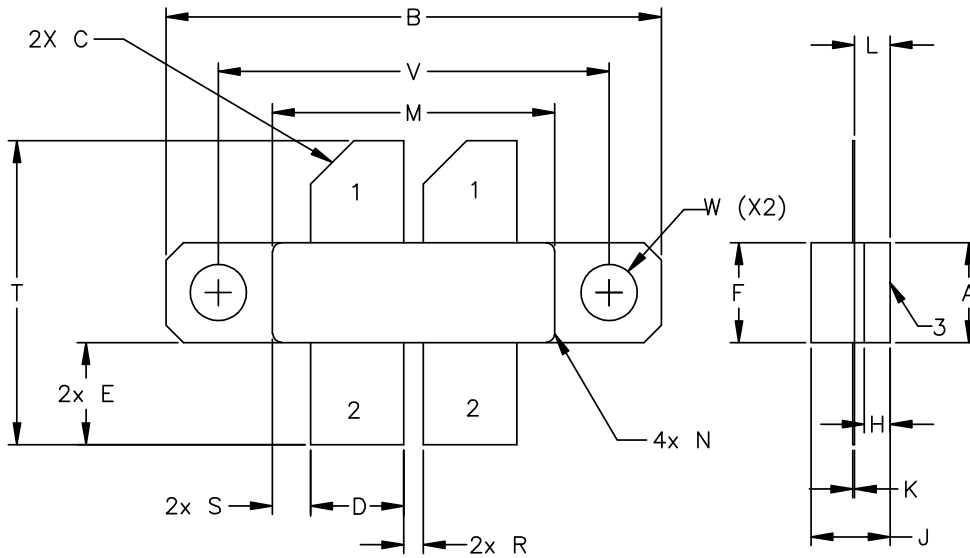



STYLE 1:
 PIN 1. GATE
 2. DRAIN
 3. SOURCE

NOTES:

1. DIMENSIONING AND TOLERANCING PER ANSI Y14.5M, 1982.
2. CONTROLLING DIMENSION: INCH.
3. ADHESIVE FROM LID MAY EXTEND A MAXIMUM OF 0.020" BEYOND EDGE OF LID.
4. LID MAY BE MISALIGNED TO THE BODY OF PACKAGE BY A MAXIMUM OF 0.008" IN ANY DIRECTION.

| DIM | INCHES | | MILLIMETERS | |
|-----|-----------|---------|-------------|---------|
| | MIN | MAX | MIN | MAX |
| A | 0.225 | 0.235 | 5.72 | 5.97 |
| B | 1.135 | 1.145 | 28.83 | 29.00 |
| C | 0.10 | 45° REF | 2.54 | 45° REF |
| D | 0.210 | 0.220 | 5.33 | 5.59 |
| E | 0.230 | 0.240 | 5.84 | 6.00 |
| F | 0.225 | 0.235 | 5.71 | 5.97 |
| H | 0.055 | 0.065 | 1.40 | 1.65 |
| J | 0.151 | 0.171 | 3.84 | 4.34 |
| K | 0.003 | 0.006 | 0.08 | 0.15 |
| L | 0.075 | 0.085 | 1.91 | 2.16 |
| M | 0.643 | 0.657 | 16.30 | 16.70 |
| N | R.020 REF | | R0.51 REF | |
| R | 0.040 | 0.050 | 1.00 | 1.27 |
| S | 0.083 | 0.093 | 2.10 | 2.36 |
| T | 0.680 | 0.720 | 17.30 | 18.30 |
| V | 0.895 | 0.905 | 22.70 | 22.98 |
| W | ø.130 | | ø 3.30 | |

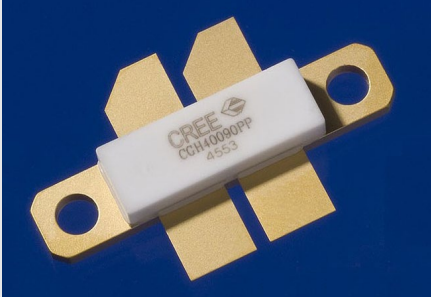
Product Ordering Information

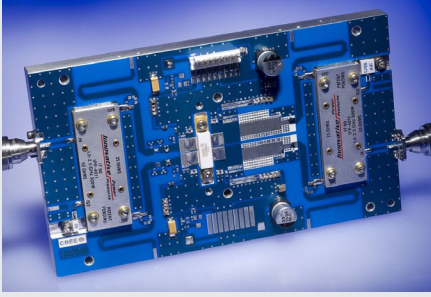
| Order Number | Description | Unit of Measure | Image |
|----------------|------------------------------------|-----------------|---|
| CGH40090PP | GaN HEMT | Each |  |
| CGH40090PP-TB | Test board without GaN HEMT | Each |  |
| CGH40090PP-AMP | Test board with GaN HEMT installed | Each |  |



Disclaimer

Specifications are subject to change without notice. Cree, Inc. believes the information contained within this data sheet to be accurate and reliable. However, no responsibility is assumed by Cree for any infringement of patents or other rights of third parties which may result from its use. No license is granted by implication or otherwise under any patent or patent rights of Cree. Cree makes no warranty, representation or guarantee regarding the suitability of its products for any particular purpose. "Typical" parameters are the average values expected by Cree in large quantities and are provided for information purposes only. These values can and do vary in different applications and actual performance can vary over time. All operating parameters should be validated by customer's technical experts for each application. Cree products are not designed, intended or authorized for use as components in applications intended for surgical implant into the body or to support or sustain life, in applications in which the failure of the Cree product could result in personal injury or death or in applications for planning, construction, maintenance or direct operation of a nuclear facility.

For more information, please contact:

Cree, Inc.
4600 Silicon Drive
Durham, North Carolina, USA 27703
www.cree.com/RF

Sarah Miller
Marketing
Cree, RF Components
1.919.407.5302

Ryan Baker
Marketing & Sales
Cree, RF Components
1.919.407.7816

Tom Dekker
Sales Director
Cree, RF Components
1.919.407.5639

Looking for pricing, stock, or lifecycle information?

Click below to explore more details on WIN SOURCE:

 [View CGH40090PP on WIN SOURCE](#)

 [Cree/Wolfspeed Information](#)

Optimize Your Supply Chain with WIN SOURCE Solutions

-  Global Sourcing Solution
-  Obsolete Management
-  Cost Control Management
-  Shortage Management
-  Alternative Solution
-  Excess Inventory Management