

CNY171, CNY172, CNY173, CNY174, CNY17F1, CNY17F2, CNY17F3, CNY17F4, MOC8101, MOC8102, MOC8103, MOC8104, MOC8105, MOC8106, MOC8107, MOC8108 Phototransistor Optocouplers

Features

- CNY171/2/3/4 and CNY17F1/2/3/4 are also available in white package by specifying M suffix (eg. CNY17F2M)
- UL recognized (File # E90700)
- VDE recognized
 - Add option V for white package (e.g., CNY17F2VM)
 - File #102497
 - Add option '300' for black package (e.g., CNY17F2300)
 - File #94766
- Current transfer ratio in select groups
- High BV_{CEO} —70V minimum (CNY17X/M, CNY17FX/M, MOC8106/7/8)
- Closely matched current transfer ratio (CTR) minimizes unit-to-unit variation.
- Very low coupled capacitance along with no chip to pin 6 base connection for minimum noise susceptibility (CNY17FX/M, MOC810X)

Applications

- Power supply regulators
- Digital logic inputs
- Microprocessor inputs
- Appliance sensor systems
- Industrial controls

Description

The CNY17, CNY17F and MOC810X devices consist of a Gallium Arsenide IRED coupled with an NPN phototransistor in a dual in-line package.

White Package (-M Suffix)



Black Package (No -M Suffix)



Schematic



Absolute Maximum Ratings

Parameters	Symbol	Device	Value	Units
TOTAL DEVICE				
Storage Temperature	T_{STG}	M	-40 to +150	°C
		non M	-55 to +150	
Operating Temperature	T_{OPR}	M	-40 to +100	°C
		non M	-55 to +100	
Lead Solder Temperature	T_{SOL}	All	260 for 10 sec	°C
Total Device Power Dissipation @ 25°C (LED plus detector)	P_D	M	250	mW
Derate Linearly From 25°C		non M	250	
		M	2.94	mW/°C
		non M	3.30	
EMITTER				
Continuous Forward Current	I_F	M	60	mA
		non M	100	
Reverse Voltage	V_R	All	6	V
Forward Current - Peak (1 μ s pulse, 300 pps)	I_F (pk)	M	1.5	A
		non M	1.0	
LED Power Dissipation 25°C Ambient	P_D	M	120	mW
Derate Linearly From 25°C		non M	150	
		M	1.41	mW/°C
		non M	1.8	
DETECTOR				
Continuous Collector Current	I_C	All	50	mA
Collector-Emitter Voltage	V_{CEO}	CNY17X/M, CNY17FX/M, MOC8106/7/8	70	V
		MOC8101/2/3/4/5	30	V
Emitter Collector Voltage	V_{ECO}	All	7	V
Detector Power Dissipation @ 25°C	P_D	M	150	mW
Derate Linearly from 25°C		non M	150	
		M	1.76	mW/°C
		non M	2.0	

Electrical Characteristics ($T_A = 25^\circ\text{C}$ Unless otherwise specified.)⁽¹⁾

Individual Component Characteristics

Parameters	Test Conditions	Symbol	Device	Min	Typ	Max	Units
EMITTER							
Input Forward Voltage	$I_F = 60$ mA	V_F	CNY17FX/M CNY17X/M	1.0	1.35	1.65	V
	$I_F = 10$ mA		MOC810X	1.0	1.15	1.50	
Capacitance	$V_F = 0$ V, $f = 1.0$ MHz	C_J	All		18		pF
Reverse Leakage Current	$V_R = 6$ V	I_R	All		0.001	10	μ A

Individual Component Characteristics (Continued)

Parameters	Test Conditions	Symbol	Device	Min	Typ	Max	Units
DETECTOR							
Breakdown Voltage Collector to Emitter	$I_C = 1.0 \text{ mA}, I_F = 0$	BV_{CEO}	MOC8101/2/3/4/5	30	100		V
			MOC8106/7/8 CNY17F1/2/3/4/M CNY171/2/3/4/M	70	100		
Collector to Base	$I_C = 10 \text{ } \mu\text{A}, I_F = 0$	BV_{CBO}	CNY171/2/3/4/M	70	120		
Emitter to Collector	$I_E = 100 \text{ } \mu\text{A}, I_F = 0$	BV_{ECO}	All	7	10		
Leakage Current Collector to Emitter	$V_{CE} = 10 \text{ V}, I_F = 0$	I_{CEO}	All		1	50	nA
Collector to Base	$V_{CB} = 10 \text{ V}, I_F = 0$	I_{CBO}	CNY171/2/3/4/M			20	nA
Capacitance Collector to Emitter	$V_{CE} = 0, f = 1 \text{ MHz}$	C_{CE}	All		8		pF
Collector to Base	$V_{CB} = 0, f = 1 \text{ MHz}$	C_{CB}	CNY171/2/3/4/M		20		pF
Emitter to Base	$V_{EB} = 0, f = 1 \text{ MHz}$	C_{EB}	CNY171/2/3/4/M		10		pF

Isolation Characteristics

Characteristic	Test Conditions	Symbol	Device	Min	Typ**	Max	Units
Input-Output Isolation Voltage	$f = 60 \text{ Hz}, t = 1 \text{ min. (4)}$	V_{ISO}	Black Package	5300			Vac(rms)*
	$f = 60 \text{ Hz}, t = 1 \text{ sec. (4)}$		'M' White Package	7500			Vac(pk)
Isolation Resistance	$V_{I-O} = 500 \text{ VDC (4)}$	R_{ISO}	All	10^{11}			Ω
Isolation Capacitance	$V_{I-O} = \emptyset, f = 1 \text{ MHz (4)}$	C_{ISO}	Black Package		0.5		pF
			'M' White Package		0.2		

Note

* 5300 Vac(rms) for 1 minute equates to approximately 9000 Vac (pk) for 1 second

** Typical values at $T_A = 25^\circ\text{C}$

Transfer Characteristics ($T_A = 25^\circ\text{C}$ Unless otherwise specified.)⁽¹⁾

DC Characteristics		Test Conditions	Symbol	Min	Typ	Max	Units
Coupled							
Output Collector Current	MOC8101	$(I_F = 10 \text{ mA}, V_{CE} = 10 \text{ V})$	$(CTR)^{(2)}$	50	—	80	%
	MOC8102			73	—	117	
	MOC8103			108	—	173	
	MOC8104			160	—	256	
	MOC8105			65	—	133	
	MOC8106			50	—	150	
	MOC8107			100	—	300	
	MOC8108			250	—	600	
	CNY17F1/1M	$(I_F = 10 \text{ mA}, V_{CE} = 5 \text{ V})$		40	—	80	
	CNY17F2/2M			63	—	125	
	CNY17F3/3M			100	—	200	
	CNY17F4/4M			160	—	320	
	CNY171/1M			40	—	80	
	CNY172/2M			63	—	125	
	CNY173/3M			100	—	200	
	CNY174/4M	160	—	320			
	Collector-Emitter Saturation Voltage	CNY17XM/FXM	$(I_C = 2.5 \text{ mA}, I_F = 10 \text{ mA})$	$V_{CE(sat)}$	—	—	0.4
MOC8101/2/3/4/5/6/7/8		$(I_C = 500 \mu\text{A}, I_F = 5.0 \text{ mA})$	—		—	0.3	V
CNY17X/FX		$(I_F = 10 \text{ mA}, I_C = 2.5 \text{ mA})$	—		—	0.3	V

AC Characteristics ⁽³⁾		Test Conditions	Symbol	Min	Typ*	Max	Units
Non-Saturated Switching Time							
Turn-On Time	MOC8101/2/3/4/5	$(I_C = 2.0 \text{ mA}, V_{CC} = 10 \text{ V}, R_L = 100 \Omega)$	t_{on}	—	2	20	μs
	MOC8106/7/8					—	
	CNY17X/FX					10	
Turn-Off Time	MOC8101/2/3/4/5	$(I_C = 2.0 \text{ mA}, V_{CC} = 10 \text{ V}, R_L = 100 \Omega)$	t_{off}	—	3	20	μs
	MOC8106/7/8					—	
	CNY17X/FX					10	
Delay Time	CNY17XM/FXM	$(I_F = 10 \text{ mA}, V_{CC} = 5 \text{ V}, R_L = 75 \Omega)$	t_d	—	—	5.6	μs
Rise Time	All Devices	$(I_C = 2.0 \text{ mA}, V_{CC} = 10 \text{ V}, R_L = 100 \Omega)$	t_r	—	1	—	μs
	CNY17XM/FXM	$(I_F = 10 \text{ mA}, V_{CC} = 5 \text{ V}, R_L = 75 \Omega)$				—	
Storage Time	CNY17XM/FXM	$(I_F = 10 \text{ mA}, V_{CC} = 5 \text{ V}, R_L = 75 \Omega)$	t_s	—	—	4.1	μs
Fall Time	All Devices	$(I_C = 2.0 \text{ mA}, V_{CC} = 10 \text{ V}, R_L = 100 \Omega)$	t_f	—	2	—	μs
	CNY17XM/FXM	$(I_F = 10 \text{ mA}, V_{CC} = 5 \text{ V}, R_L = 75 \Omega)$				—	

Transfer Characteristics (continued) ($T_A = 25^\circ\text{C}$ Unless otherwise specified.)⁽¹⁾

AC Characteristics ⁽³⁾		Test Conditions	Symbol	Min	Typ	Max	Units			
Saturated Switching Times										
Turn-on Time	CNY171/F1	($I_F = 20\text{ mA}, V_{CE} = 0.4\text{ V}$)	t_{on}	—	—	5.5	μs			
	CNY172/F2 CNY173/F3 CNY174/F4	($I_F = 10\text{ mA}, V_{CE} = 0.4\text{ V}$)		—	—	8.0				
	Rise Time	CNY171/F1	($I_F = 20\text{ mA}, V_{CE} = 0.4\text{ V}$)	t_r	—	—	4.0	μs		
		CNY172/F1 CNY173/F3 CNY174/F4	($I_F = 10\text{ mA}, V_{CE} = 0.4\text{ V}$)		—	—	6.0			
CNY171M/F1M		($I_F = 20\text{ mA}, V_{CC} = 5\text{ V}, R_L = 1\text{ K}\Omega$)	—		—	4.0				
CNY172M/3M/4M CNY17F2M/F3M/F4M		($I_F = 10\text{ mA}, V_{CC} = 5\text{ V}, R_L = 1\text{ K}\Omega$)	—		—	6.0				
Delay Time		CNY171M/F1M	($I_F = 20\text{ mA}, V_{CC} = 5\text{ V}, R_L = 1\text{ K}\Omega$)		t_d	—	—		5.5	μs
CNY172M/3M/4M CNY17F2M/F3M/F4M	($I_F = 10\text{ mA}, V_{CC} = 5\text{ V}, R_L = 1\text{ K}\Omega$)	—	—	8.0						
Turn-off Time	CNY171/F1	($I_F = 20\text{ mA}, V_{CE} = 0.4\text{ V}$)	t_{off}	—	—	34	μs			
	CNY172/F2 CNY173/F3 CNY174/F4	($I_F = 10\text{ mA}, V_{CE} = 0.4\text{ V}$)		—	—	39				
	Fall Time	CNY171/F1		($I_F = 20\text{ mA}, V_{CE} = 0.4\text{ V}$)	t_f	—		—	20	μs
		CNY172/F2 CNY173/F3 CNY174/F4		($I_F = 10\text{ mA}, V_{CE} = 0.4\text{ V}$)		—		—	24	
CNY171M/F1M		($I_F = 20\text{ mA}, V_{CC} = 5\text{ V}, R_L = 1\text{ K}\Omega$)	—	—		20.0				
CNY172M/3M/4M CNY17F2M/F3M/F4M		($I_F = 10\text{ mA}, V_{CC} = 5\text{ V}, R_L = 1\text{ K}\Omega$)	—	—		24.0				
Storage Time		CNY171M/F1M	($I_F = 20\text{ mA}, V_{CC} = 5\text{ V}, R_L = 1\text{ K}\Omega$)	t_s		—	—	34.0	μs	
CNY172M/3M/4M CNY17F2M/F3M/F4M	($I_F = 10\text{ mA}, V_{CC} = 5\text{ V}, R_L = 1\text{ K}\Omega$)	—	—		39.0					

** All typicals at $T_A = 25^\circ\text{C}$

Notes:

1. Always design to the specified minimum/maximum electrical limits (where applicable).
2. Current Transfer Ratio (CTR) = $I_C/I_F \times 100\%$.
3. For test circuit setup and waveforms, refer to Figures 20.
4. For this test, Pins 1 and 2 are common, and Pins 4 and 5 are common.

Fig.1 Normalized CTR vs. Forward Current (Black Package)

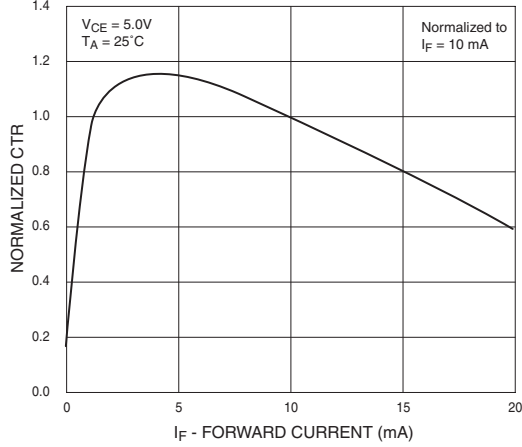

Fig.2 Normalized CTR vs. Forward Current (White Package)

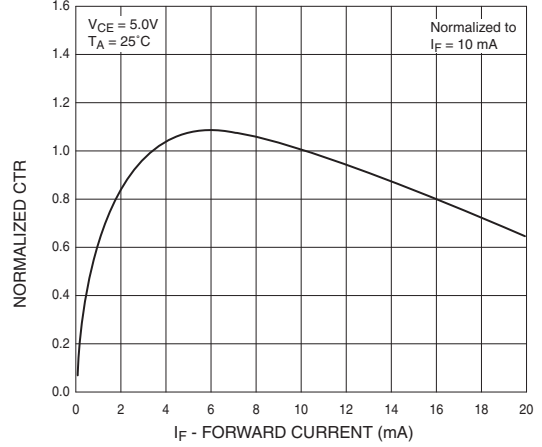

Fig. 3 Normalized CTR vs. Ambient Temperature (Black Package)

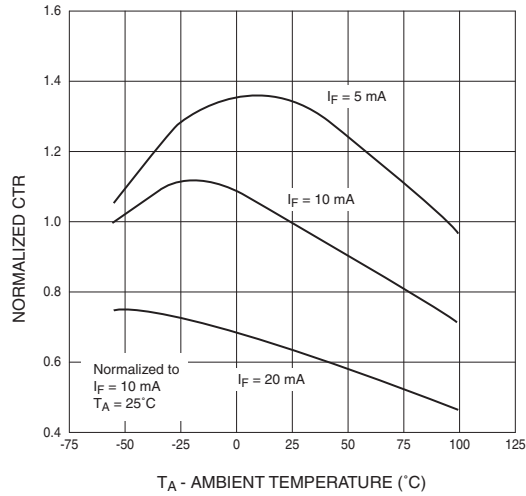

Fig. 4 Normalized CTR vs. Ambient Temperature (White Package)

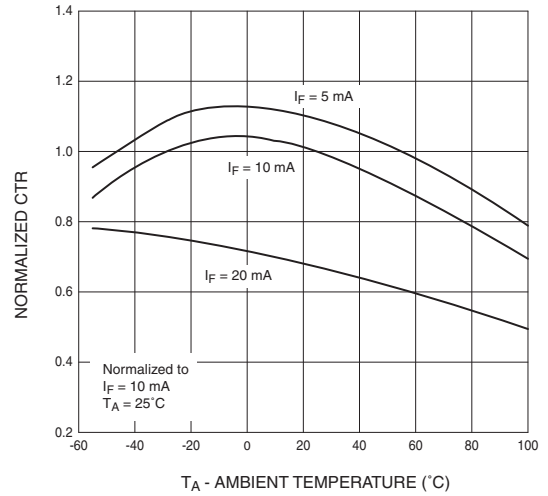
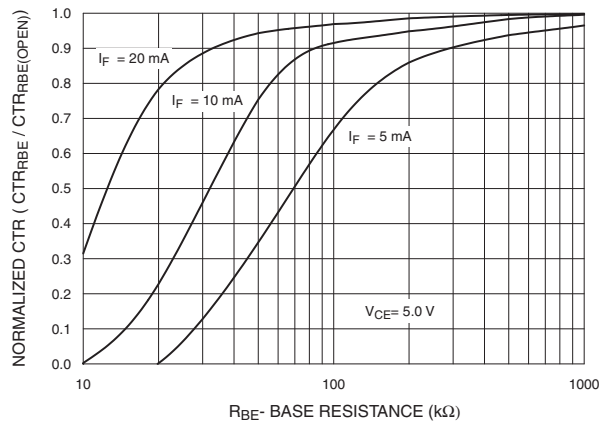

Fig. 5 CTR vs. RBE (Unsatrated) (Black Package)



Fig. 6 CTR vs. RBE (Unsatrated) (White Package)



**Fig. 7 CTR vs. RBE (Saturated)
(Black Package)**



**Fig. 8 CTR vs. RBE (Saturated)
(White Package)**



**Fig. 9 Switching Speed vs. Load Resistor
(Black Package)**



**Fig. 10 Switching Speed vs. Load Resistor
(White Package)**



**Fig. 11 Normalized t_on vs. RBE
(Black Package)**



**Fig. 12 Normalized t_on vs. RBE
(White Package)**



Fig. 13 Normalized t_{off} vs. R_{BE} (Black Package)



Fig. 14 Normalized t_{off} vs. R_{BE} (White Package)



Fig. 15 LED Forward Voltage vs. Forward Current (Black Package)



Fig. 16 LED Forward Voltage vs. Forward Current (White Package)



Fig. 17 Collector-Emitter Saturation Voltage vs. Collector Current (Black Package)



Fig. 18 Collector-Emitter Saturation Voltage vs. Collector Current (White Package)



Fig. 19 Dark Current vs. Ambient Temperature (Black Package)

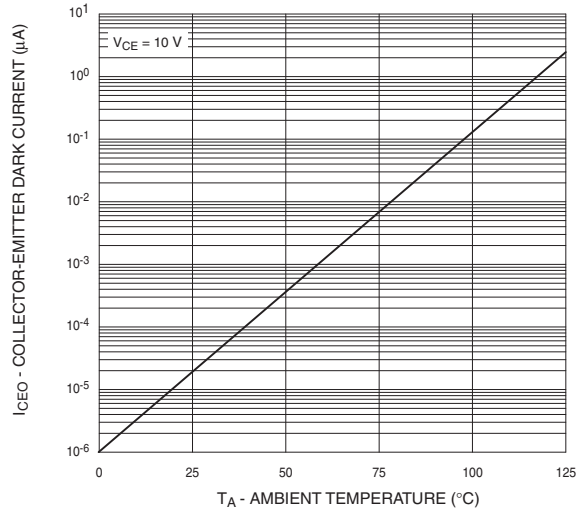

Figure 20. Switching Time Test Circuit



Figure 21. Switching Time Test Circuit

Black Package (No -M Suffix)

Package Dimensions (Through Hole)

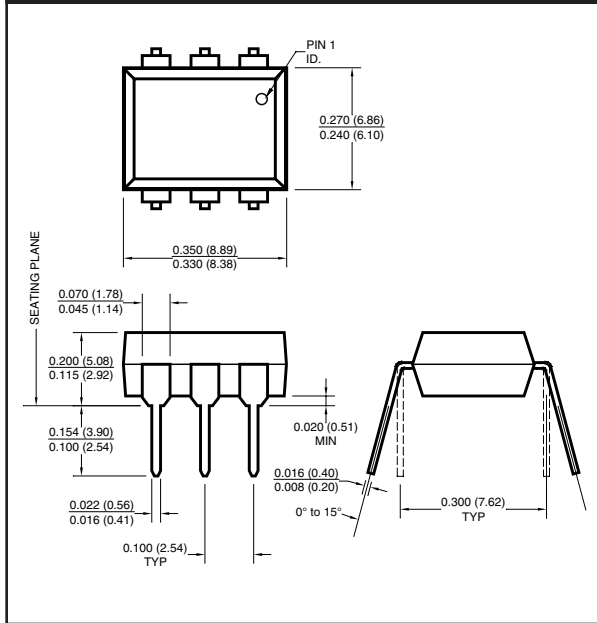

Package Dimensions (Surface Mount)

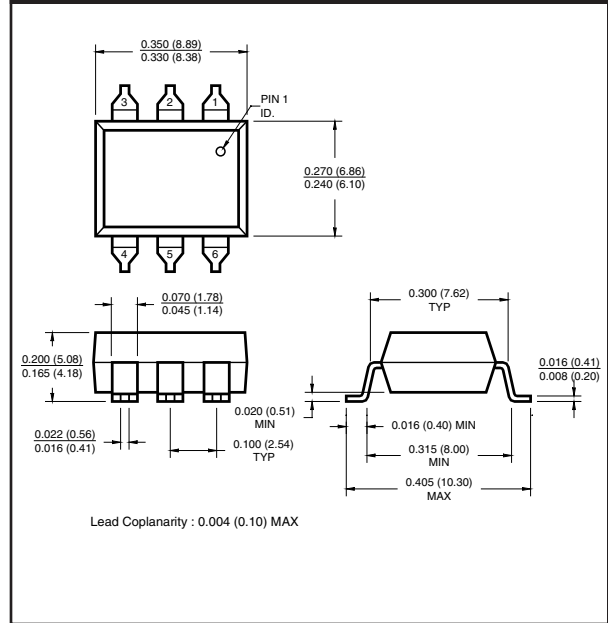

Package Dimensions (0.4" Lead Spacing)

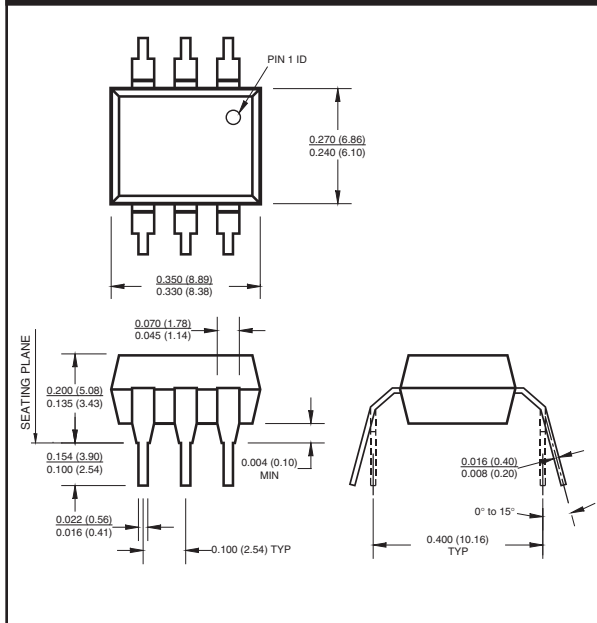

Recommended Pad Layout for Surface Mount Leadform (Black Package Only)

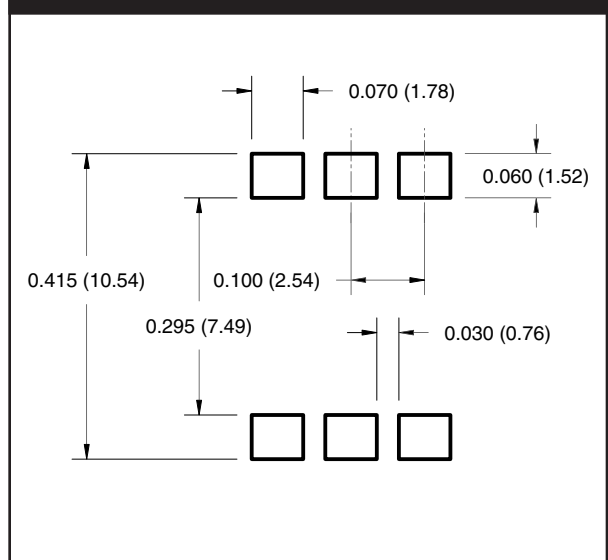

NOTE

All dimensions are in inches (millimeters)

White Package (-M Suffix)

Package Dimensions (Through Hole)

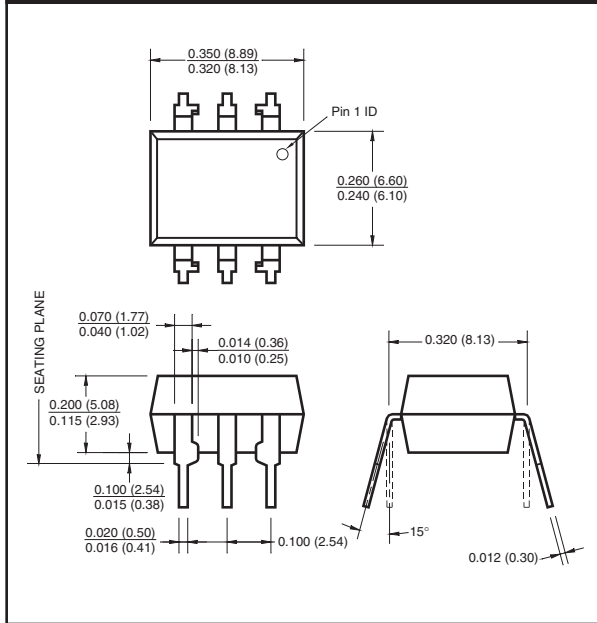

Package Dimensions (Surface Mount)

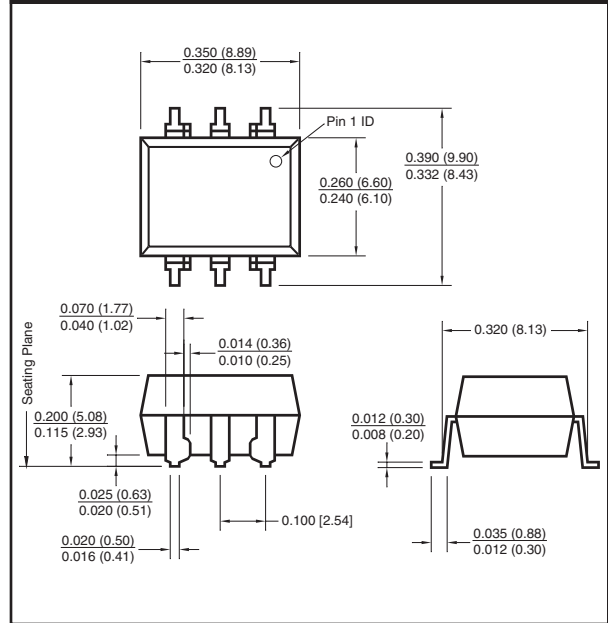

Package Dimensions (0.4" Lead Spacing)

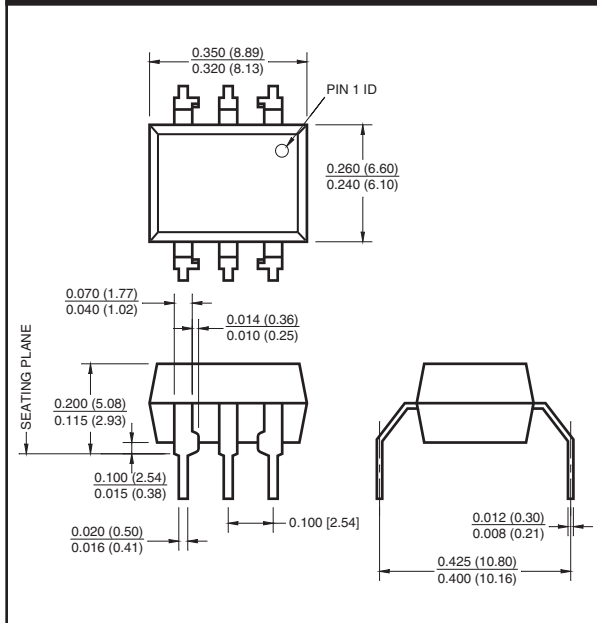

Recommended Pad Layout for Surface Mount Leadform (White Package Only)

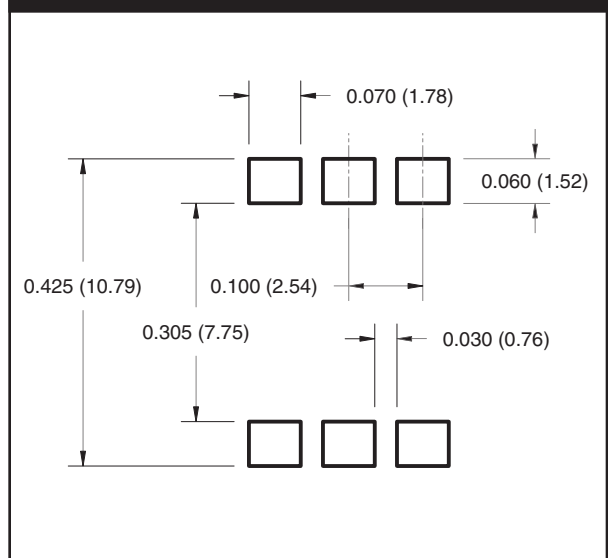

NOTE

All dimensions are in inches (millimeters)

Ordering Information

Black Package Part Number Example (No Suffix)	White Package Part Number Example (M Suffix)	Description
CNY171S	CNY171SM	Surface Mount Lead Bend
CNY171SD	CNY171SR2M	Surface Mount; Tape and reel
CNY171W	CNY171TM	0.4" Lead Spacing
CNY171300	CNY171VM	VDE Approved
CNY171300W	CNY171TVM	VDE Approved, 0.4" Lead Spacing
CNY1713S	CNY171SVM	VDE Approved, Surface Mount
CNY1713SD	CNY171SR2VM	VDE Approved, Surface Mount, Tape & Reel

Carrier Tape Specifications (Black Package, No Suffix)



Carrier Tape Specifications (White Package, M Suffix)



Marking Information (Black package non 'M' suffix)



Definitions	
1	Fairchild logo
2	Device number
3	VDE mark (Note: Only appears on parts ordered with VDE option – See order entry table)
4	Two digits year code, e.g., '03'; One digit year code for 'M' version, e.g. '5'
5	Two digit work week ranging from '01' to '53'
6	Assembly package code

Reflow Profile (Black Package, No Suffix)

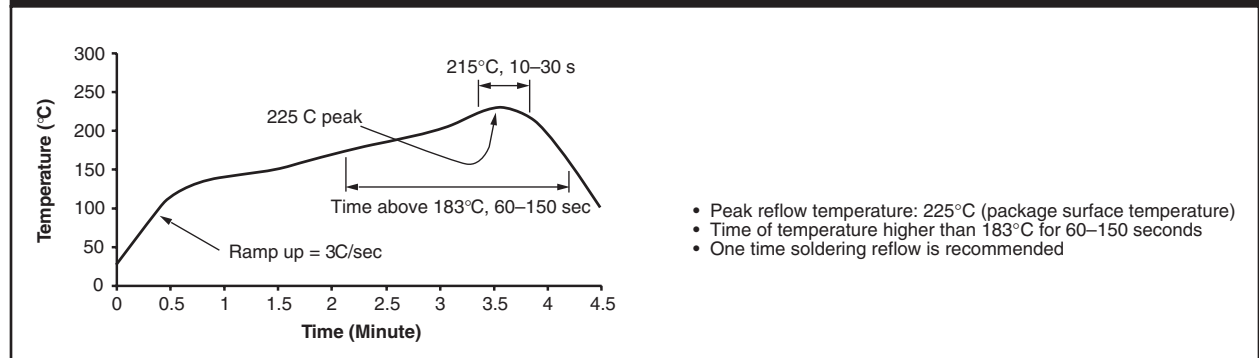

Marking Information (White package M suffix)



Definitions	
1	Fairchild logo
2	Device number
3	VDE mark (Note: Only appears on parts ordered with VDE option – See order entry table)
4	Single digit year code, e.g. '5'
5	Two digit work week ranging from '01' to '53'
6	Assembly package code

Reflow Profile (White Package, M Suffix)



TRADEMARKS

The following are registered and unregistered trademarks Fairchild Semiconductor owns or is authorized to use and is not intended to be an exhaustive list of all such trademarks.

ACEx™	FAST®	ISOPLANAR™	PowerSaver™	SuperSOT™-8
ActiveArray™	FASTr™	LittleFET™	PowerTrench®	SyncFET™
Bottomless™	FPS™	MICROCOUPLER™	QFET®	TinyLogic®
Build it Now™	FRFET™	MicroFET™	QS™	TINYOPTO™
CoolFET™	GlobalOptoisolator™	MicroPak™	QT Optoelectronics™	TruTranslation™
CROSSVOLT™	GTO™	MICROWIRE™	Quiet Series™	UHC™
DOMET™	HiSeC™	MSX™	RapidConfigure™	UltraFET®
EcoSPARK™	I ² C™	MSXPro™	RapidConnect™	UniFET™
E ² CMOS™	i-Lo™	OCX™	μSerDes™	VCX™
EnSigna™	ImpliedDisconnect™	OCXPro™	SILENT SWITCHER®	Wire™
FACT™	IntelliMAX™	OPTOLOGIC®	SMART START™	
FACT Quiet Series™		OPTOPLANAR™	SPM™	
Across the board. Around the world.™		PACMAN™	Stealth™	
The Power Franchise®		POP™	SuperFET™	
Programmable Active Droop™		Power247™	SuperSOT™-3	
		PowerEdge™	SuperSOT™-6	

DISCLAIMER

FAIRCHILD SEMICONDUCTOR RESERVES THE RIGHT TO MAKE CHANGES WITHOUT FURTHER NOTICE TO ANY PRODUCTS HEREIN TO IMPROVE RELIABILITY, FUNCTION OR DESIGN. FAIRCHILD DOES NOT ASSUME ANY LIABILITY ARISING OUT OF THE APPLICATION OR USE OF ANY PRODUCT OR CIRCUIT DESCRIBED HEREIN; NEITHER DOES IT CONVEY ANY LICENSE UNDER ITS PATENT RIGHTS, NOR THE RIGHTS OF OTHERS.

LIFE SUPPORT POLICY

FAIRCHILD'S PRODUCTS ARE NOT AUTHORIZED FOR USE AS CRITICAL COMPONENTS IN LIFE SUPPORT DEVICES OR SYSTEMS WITHOUT THE EXPRESS WRITTEN APPROVAL OF FAIRCHILD SEMICONDUCTOR CORPORATION. As used herein:

1. Life support devices or systems are devices or systems which, (a) are intended for surgical implant into the body, or (b) support or sustain life, or (c) whose failure to perform when properly used in accordance with instructions for use provided in the labeling, can be reasonably expected to result in significant injury to the user.
2. A critical component is any component of a life support device or system whose failure to perform can be reasonably expected to cause the failure of the life support device or system, or to affect its safety or effectiveness.

PRODUCT STATUS DEFINITIONS

Definition of Terms

Datasheet Identification	Product Status	Definition
Advance Information	Formative or In Design	This datasheet contains the design specifications for product development. Specifications may change in any manner without notice.
Preliminary	First Production	This datasheet contains preliminary data, and supplementary data will be published at a later date. Fairchild Semiconductor reserves the right to make changes at any time without notice in order to improve design.
No Identification Needed	Full Production	This datasheet contains final specifications. Fairchild Semiconductor reserves the right to make changes at any time without notice in order to improve design.
Obsolete	Not In Production	This datasheet contains specifications on a product that has been discontinued by Fairchild semiconductor. The datasheet is printed for reference information only.

Rev. 116

Looking for pricing, stock, or lifecycle information?

Click below to explore more details on WIN SOURCE:

- ⊖ [View CNY17F1300W on WIN SOURCE](#)
- ⊖ [Fairchild/ON Semiconductor Information](#)

Optimize Your Supply Chain with WIN SOURCE Solutions

- ✓ Global Sourcing Solution
- ✓ Obsolete Management
- ✓ Cost Control Management
- ✓ Shortage Management
- ✓ Alternative Solution
- ✓ Excess Inventory Management