



**THE DATASHEET OF
DG412CY+T**





Improved, Quad, SPST Analog Switches

DG411/DG412/DG413

General Description

Maxim's redesigned DG411/DG412/DG413 analog switches now feature low on-resistance matching between switches (3Ω max) and guaranteed on-resistance flatness over the signal range ($\Delta 4\Omega$ max). These low on-resistance switches conduct equally well in either direction. They guarantee low charge injection, low power consumption, and an ESD tolerance of 2000V minimum per Method 3015.7. The new design offers lower off-leakage current over temperature (less than 5nA at +85°C).

The DG411/DG412/DG413 are quad, single-pole/single-throw (SPST) analog switches. The DG411 is normally closed (NC), and the DG412 is normally open (NO). The DG413 has two NC switches and two NO switches. Switching times are less than 150ns max for t_{ON} and less than 100ns max for t_{OFF} . These devices operate from a single +10V to +30V supply, or bipolar $\pm 4.5V$ to $\pm 20V$ supplies. Maxim's improved DG411/DG412/DG413 are fabricated with a 44V silicon-gate process.

Applications

- | | |
|----------------------------|--------------------------|
| Sample-and-Hold Circuits | Communication Systems |
| Test Equipment | Battery-Operated Systems |
| Heads-Up Displays | PBX, PABX |
| Guidance & Control Systems | Audio Signal Routing |
| Military Radios | |

New Features

- ◆ Plug-In Upgrade for Industry-Standard DG411/DG412/DG413
- ◆ Improved $R_{DS(ON)}$ Match Between Channels (3Ω max)
- ◆ Guaranteed $R_{FLAT(ON)}$ Over Signal Range ($\Delta 4\Omega$)
- ◆ Improved Charge Injection (10pC max)
- ◆ Improved Off-Leakage Current Over Temperature (< 5nA at +85°C)
- ◆ Withstand Electrostatic Discharge (2000V min) per Method 3015.7

Existing Features

- ◆ Low $R_{DS(ON)}$ (35Ω max)
- ◆ Single-Supply Operation +10V to +30V
- ◆ Bipolar-Supply Operation $\pm 4.5V$ to $\pm 20V$
- ◆ Low Power Consumption ($35\mu W$ max)
- ◆ Rail-to-Rail Signal Handling
- ◆ TTL/CMOS-Logic Compatible

Ordering Information

PART	TEMP RANGE	PIN-PACKAGE
DG411CJ	0°C to +70°C	16 Plastic DIP
DG411CUE	0°C to +70°C	16 TSSOP
DG411EUE	-40°C to +85°C	16 TSSOP
DG411CY	0°C to +70°C	16 Narrow SO
DG411C/D	0°C to +70°C	Dice†

Ordering Information continued at end of data sheet.

†Contact factory for dice specifications.

Pin Configurations/Functional Diagrams/Truth Tables

TOP VIEW

DIP/SO/TSSOP
DG411

LOGIC	SWITCH
0	ON
1	OFF

DIP/SO/TSSOP
DG412

LOGIC	SWITCH
0	OFF
1	ON

DIP/SO/TSSOP
DG413

LOGIC	SWITCHES 1, 4	SWITCHES 2, 3
0	OFF	ON
1	ON	OFF

SWITCHES SHOWN FOR LOGIC "0" INPUT

Pin Configurations and Functional Diagrams continued at end of data sheet.

Improved, Quad, SPST Analog Switches

ABSOLUTE MAXIMUM RATINGS

(All Voltages Referenced to V-.)

V+44V
GND25V
V _L(GND -0.3V) to (V+ +0.3V)
Digital Inputs, V _S , V _D (Note 1)(V- -2V) to (V+ +2V) or 30mA (whichever occurs first)
Continuous Current (any terminal)30mA
Peak Current (pulsed at 1ms, 10% duty cycle max)100mA

Continuous Power Dissipation (T_A = +70°C)

16-Pin Plastic DIP (derate 10.53mW/°C above +70°C)	.842mW
16-Pin Narrow SO (derate 8.70mW/°C above +70°C)	...696mW
16-Pin CERDIP (derate 10.00mW/°C above +70°C)800mW
16-Pin TSSOP (derate 6.7mW/°C above +70°C)457mW
16-Pin QFN (derate 19.2mW/°C above +70°C)1538mW

Operating Temperature Ranges

DG41_C0°C to +70°C
DG41_D-40°C to +85°C
DG41_AK-55°C to +125°C
Storage Temperature Range-65°C to +150°C
Lead Temperature (soldering, 10s)+300°C

Note 1: Signals on S, D, or IN exceeding V+ or V- are clamped by internal diodes. Limit forward current to maximum current rating.

Stresses beyond those listed under "Absolute Maximum Ratings" may cause permanent damage to the device. These are stress ratings only, and functional operation of the device at these or any other conditions beyond those indicated in the operational sections of the specifications is not implied. Exposure to absolute maximum rating conditions for extended periods may affect device reliability.

ELECTRICAL CHARACTERISTICS—Dual Supplies

(V+ = 15V, V- = -15V, V_L = 5V, V_{GND} = 0V, V_{INH} = 2.4V, V_{INL} = 0.8V, T_A = T_{MIN} to T_{MAX}, unless otherwise noted.)

PARAMETER	SYMBOL	CONDITIONS		MIN	TYP (Note 2)	MAX	UNITS	
SWITCH								
Analog Signal Range	V _{ANALOG}	(Note 3)		-15		15	V	
Drain-Source On-Resistance	R _{DS(ON)}	V+ = 13.5V, V- = -13.5V, V _D = ±8.5V, I _S = -10mA	T _A = +25°C	C, D	17	45	Ω	
				A	17	30		
			T _A = T _{MIN} to T _{MAX}			45		
On-Resistance Match Between Channels (Note 4)	ΔR _{DS(ON)}	V+ = 15V, V- = -15V, V _D = ±10V, I _S = -10mA	T _A = +25°C			3	Ω	
				T _A = T _{MIN} to T _{MAX}		5		
On-Resistance Flatness (Note 4)	R _{FLAT(ON)}	V+ = 15V, V- = -15V, V _D = ±5V, 0V, I _S = -10mA	T _A = +25°C			4	Ω	
				T _A = T _{MIN} to T _{MAX}		6		
Source Off-Leakage Current (Note 7)	I _{S(OFF)}	V+ = 16.5V, V- = -16.5V, V _D = ±15.5V, V _S = ±15.5V	T _A = +25°C	C, D, A	-0.25	-0.10	0.25	nA
				C, D	-5		5	
				A	-10		10	
Drain Off-Leakage Current (Note 7)	I _{D(OFF)}	V+ = 16.5V, V- = -16.5V, V _D = ±15.5V, V _S = ±15.5V	T _A = +25°C	C, D, A	-0.25	-0.10	0.25	nA
				C, D	-5		5	
				A	-10		10	
Drain On-Leakage Current (Note 7)	I _{D(ON)} + I _{S(ON)}	V+ = 16.5V, V- = -16.5V, V _D = ±15.5V, V _S = ±15.5V	T _A = +25°C	C, D, A	-0.4	-0.1	0.4	nA
				C, D	-20		20	
				A	-40		40	

Improved, Quad, SPST Analog Switches

DG411/DG412/DG413

ELECTRICAL CHARACTERISTICS—Dual Supplies (continued)

(V+ = 15V, V- = -15V, VL = 5V, VGND = 0V, VINH = 2.4V, VINL = 0.8V, TA = TMIN to TMAX, unless otherwise noted.)

PARAMETER	SYMBOL	CONDITIONS	MIN	TYP (Note 2)	MAX	UNITS	
INPUT							
Input Current with Input Voltage High	I _{INH}	IN = 2.4V, all others = 0.8V	-0.500	0.005	0.500	μA	
Input Current with Input Voltage Low	I _{INL}	IN = 0.8V, all others = 2.4V	-0.500	0.005	0.500	μA	
SUPPLY							
Power-Supply Range			±4.5		±20.0	V	
Positive Supply Current	I+	All channels on or off, V+ = 16.5V, V- = -16.5V, VIN = 0V or 5V	TA = +25°C	-1	0.0001	1	μA
			TA = TMIN to TMAX	-5		5	
Negative Supply Current	I-	All channels on or off, V+ = 16.5V, V- = -16.5V, VIN = 0V or 5V	TA = +25°C	-1	-0.0001	1	μA
			TA = TMIN to TMAX	-5		5	
Logic Supply Current	IL	All channels on or off, V+ = 16.5V, V- = -16.5V, VIN = 0V or 5V	TA = +25°C	-1	0.0001	1	μA
			TA = TMIN to TMAX	-5		5	
Ground Current	IGND	All channels on or off, V+ = 16.5V, V- = -16.5V, VIN = 0V or 5V	TA = +25°C	-1	-0.0001	1	μA
			TA = TMIN to TMAX	-5		5	
DYNAMIC							
Turn-On Time	t _{ON}	VD = ±10V, Figure 2	TA = +25°C	110	175	ns	
			TA = TMIN to TMAX		220		
Turn-Off Time	t _{OFF}	VD = ±10V, Figure 2	TA = +25°C	100	145	ns	
			TA = TMIN to TMAX		160		
Break-Before-Make Time Delay	t _D	DG413 only, RL = 300Ω, CL = 35pF, Figure 3	TA = +25°C	25		ns	
Charge Injection (Note 3)	Q	CL = 1.0nF, VGEN = 0V, RGEN = 0Ω, Figure 4	TA = +25°C	5	10	pC	
Off-Isolation (Note 5)	OIRR	RL = 50Ω, CL = 5pF, f = 1MHz, Figure 5	TA = +25°C	68		dB	
Crosstalk (Note 6)		RL = 50Ω, CL = 5pF, f = 1MHz, Figure 6	TA = +25°C	85		dB	
Source Off-Capacitance	CS(OFF)	f = 1MHz, Figure 7	TA = +25°C	9		pF	
Drain Off-Capacitance	CD(OFF)	f = 1MHz, Figure 7	TA = +25°C	9		pF	
Drain On-Capacitance	CD(ON) + CS(ON)	f = 1MHz, Figure 8	TA = +25°C	35		pF	

Improved, Quad, SPST Analog Switches

ELECTRICAL CHARACTERISTICS—Single Supply

(V+ = 12V, V- = 0V, VL = 5V, VGND = 0V, VINH = 2.4V, VINL = 0.8V, TA = TMIN to TMAX, unless otherwise noted.)

PARAMETER	SYMBOL	CONDITIONS		MIN	TYP (Note 2)	MAX	UNITS
SWITCH							
Analog Signal Range	VANALOG	(Note 3)		0		12	V
Drain-Source On-Resistance	RDS(ON)	V+ = 10.8V, VD = 3.8V, IS = -10mA	TA = +25°C		40	80	Ω
			TA = TMIN to TMAX			100	
SUPPLY							
Positive Supply Current	I+	All channels on or off, V+ = 13.2V, VIN = 0V or 5V	TA = +25°C	-1	0.0001	1	μA
			TA = TMAX	-5		5	
Negative Supply Current	I-	All channels on or off, V+ = 13.2V, VIN = 0V or 5V	TA = +25°C	-1	0.0001	1	μA
			TA = TMAX	-5		5	
Logic Supply Current	IL	All channels on or off, VL = 5.25V, VIN = 0V or 5V	TA = +25°C	-1	0.0001	1	μA
			TA = TMAX	-5		5	
Ground Current	IGND	All channels on or off, VL = 5.25V, VIN = 0V or 5V	TA = +25°C	-1	-0.0001	1	μA
			TA = TMAX	-5		5	
DYNAMIC							
Turn-On Time	tON	VS = 8V, Figure 2	TA = +25°C		175	250	ns
			TA = TMIN to TMAX			315	
Turn-Off Time	tOFF	VS = 8V, Figure 2	TA = +25°C		95	125	ns
			TA = TMIN to TMAX			140	
Break-Before-Make Time Delay	tD	DG413 only, RL = 300Ω, CL = 35pF, Figure 3	TA = +25°C		25		ns
Charge Injection (Note 3)	Q	CL = 1.0nF, VGEN = 0V, RGEN = 0V, Figure 4	TA = +25°C		5	10	pC

Note 2: The algebraic convention, where the most negative value is a minimum and the most positive value a maximum, is used in this data sheet.

Note 3: Guaranteed by design.

Note 4: $\Delta R_{ON} = \Delta R_{ON\ max} - \Delta R_{ON\ min}$. On-resistance match between channels and flatness are guaranteed only with bipolar-supply operation. Flatness is defined as the difference between the maximum and minimum value of on-resistance as measured at the extremes of the specified analog signal range.

Note 5: Off-Isolation = $20\log(V_D/V_S)$, VD = output, VS = input to off switch. See Figure 5.

Note 6: Between any two switches. See Figure 6.

Note 7: Leakage parameters IS(OFF), ID(OFF), and ID(ON) are 100% tested at the maximum-rated hot temperature and guaranteed by correlation at +25°C.

Improved, Quad, SPST Analog Switches

Typical Operating Characteristics

($T_A = +25^\circ\text{C}$, unless otherwise noted.)

DG411/DG412/DG413

ON-RESISTANCE vs. V_D AND POWER-SUPPLY VOLTAGE



ON-RESISTANCE vs. V_D AND TEMPERATURE

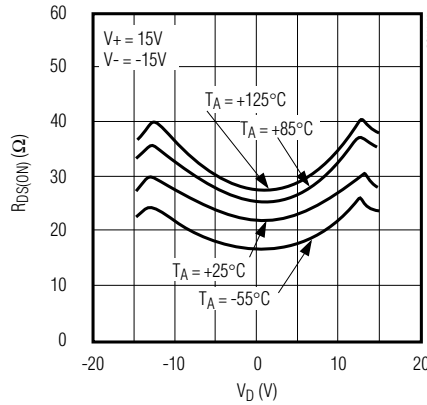

ON-RESISTANCE vs. V_D AND TEMPERATURE (SINGLE SUPPLY)



ON-RESISTANCE vs. V_D (SINGLE SUPPLY)



OFF-LEAKAGE CURRENTS vs. TEMPERATURE



ON-LEAKAGE CURRENTS vs. TEMPERATURE

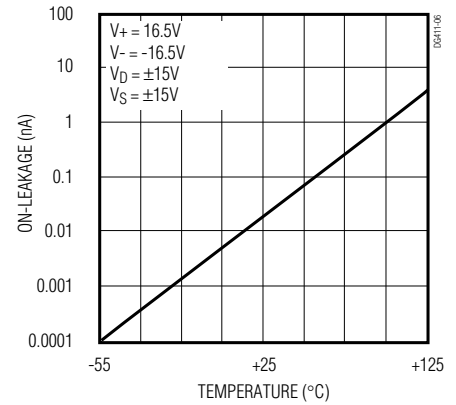

CHARGE INJECTION vs. ANALOG VOLTAGE



SUPPLY CURRENT vs. TEMPERATURE



Improved, Quad, SPST Analog Switches

Pin Description

PIN		NAME	FUNCTION
DIP/SO/TSSOP	QFN		
1, 16, 9, 8	15, 14, 7, 6	IN1–IN4	Input
2, 15, 10, 7	16, 13, 8, 5	D1–D4	Analog Switch Drain Terminal
3, 14, 11, 6	1, 12, 9, 4	S1–S4	Analog Switch Source Terminal
4	2	V-	Negative-Supply Voltage Input
5	3	GND	Ground
12	10	V _L	Logic Supply Voltage
13	11	V+	Positive-Supply Voltage Input—Connected to Substrate
—	—	EP	Exposed Paddle (QFN Only). Connect EP to V+.

Applications Information

Operation with Supply Voltages Other Than 15V

Using supply voltages other than 15V will reduce the analog signal range. The DG411/DG412/DG413 switches operate with $\pm 4.5\text{V}$ to $\pm 20\text{V}$ bipolar supplies or with a +10V to +30V single supply; connect V- to 0V when operating with a single supply. Also, all device types can operate with unbalanced supplies such as +24V and -5V. V_L must be connected to +5V to be TTL compatible, or to V+ for CMOS-logic level inputs. The *Typical Operating Characteristics* graphs show typical on-resistance with $\pm 15\text{V}$, $\pm 10\text{V}$, and $\pm 5\text{V}$ supplies. (Switching times increase by a factor of two or more for operation at $\pm 5\text{V}$.)

Overvoltage Protection

Proper power-supply sequencing is recommended for all CMOS devices. Do not exceed the absolute maximum ratings because stresses beyond the listed ratings may cause permanent damage to the devices. Always sequence V+ on first, followed by V_L, V-, and logic inputs. If power-supply sequencing is not possible, add two small, external signal diodes in series with supply pins for overvoltage protection (Figure 1).

Adding diodes reduces the analog signal range to 1V below V+ and 1V below V-, without affecting low switch resistance and low leakage characteristics. Device operation is unchanged, and the difference between V+ and V- should not exceed +44V.

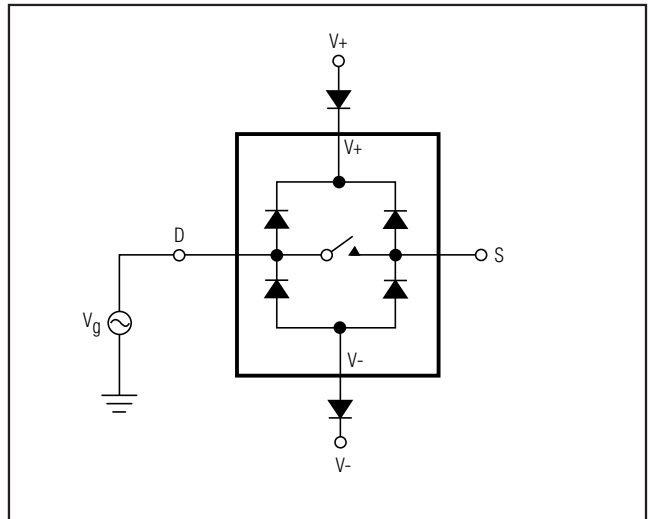

Figure 1. Overvoltage Protection Using External Blocking Diodes

Improved, Quad, SPST Analog Switches

Timing Diagrams/Test Circuits

DG411/DG412/DG413

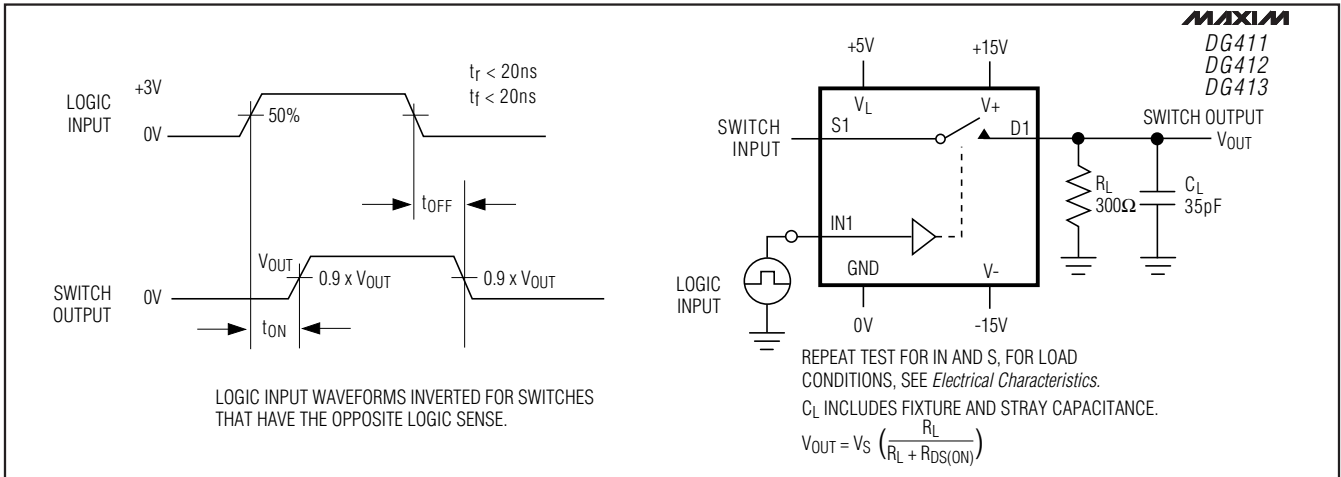

Figure 2. Switching-Time

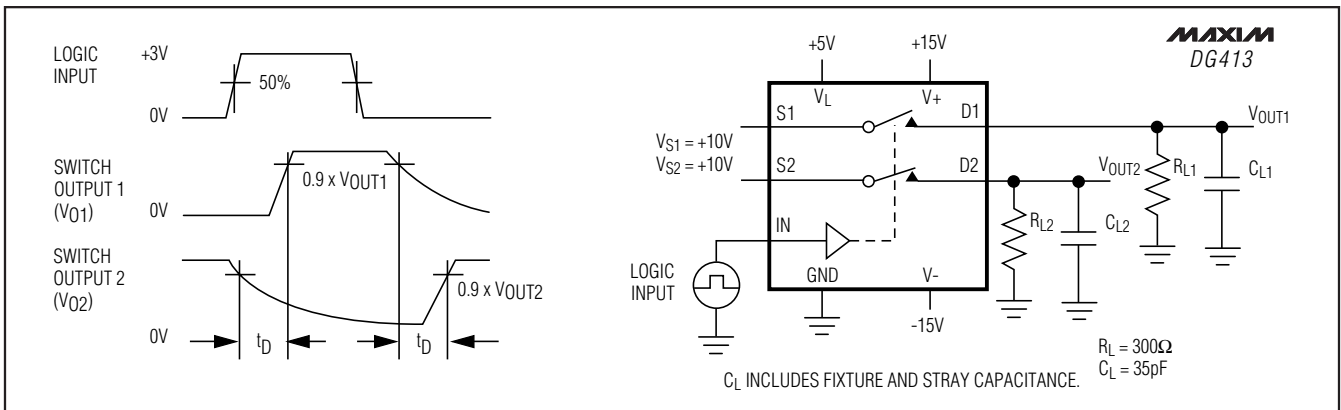

Figure 3. DG413 Break-Before-Make

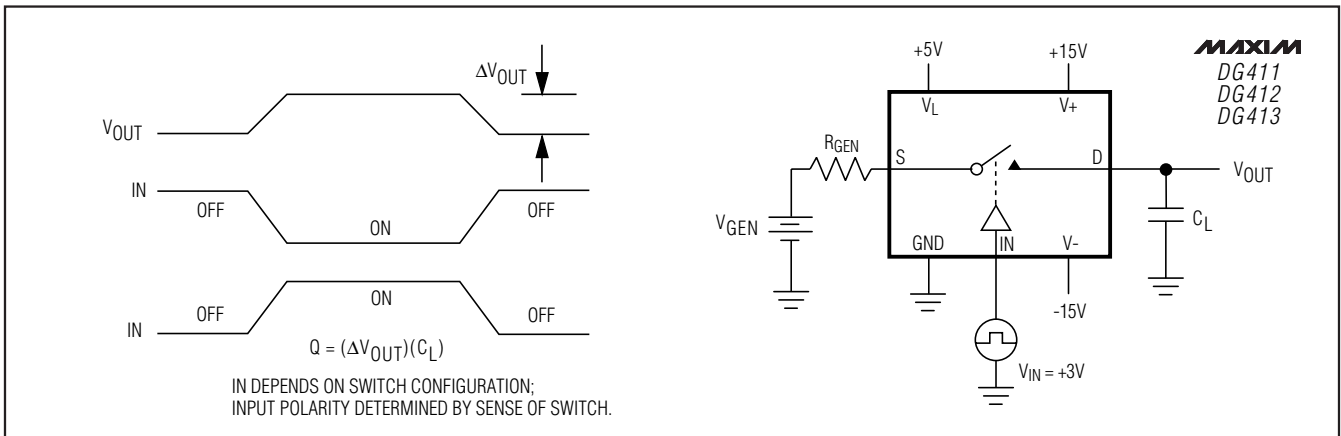

Figure 4. Charge-Injection

Improved, Quad, SPST Analog Switches

Timing Diagrams/Test Circuits (continued)

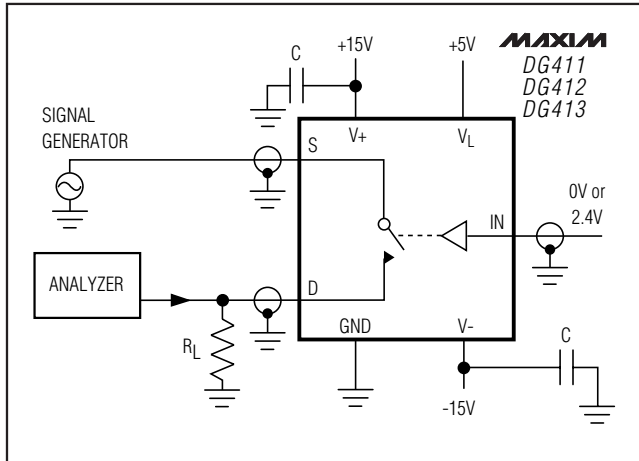

Figure 5. Off-Isolation

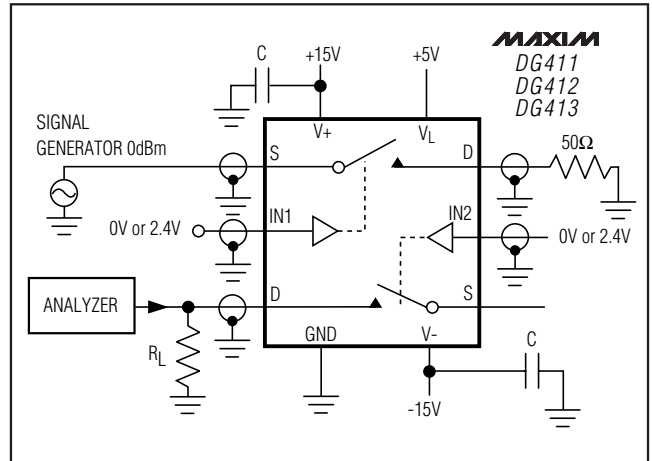

Figure 6. Crosstalk

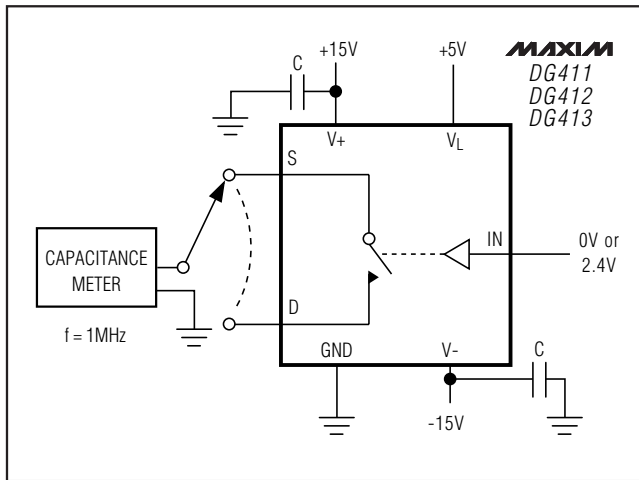

Figure 7. Channel Off-Capacitance

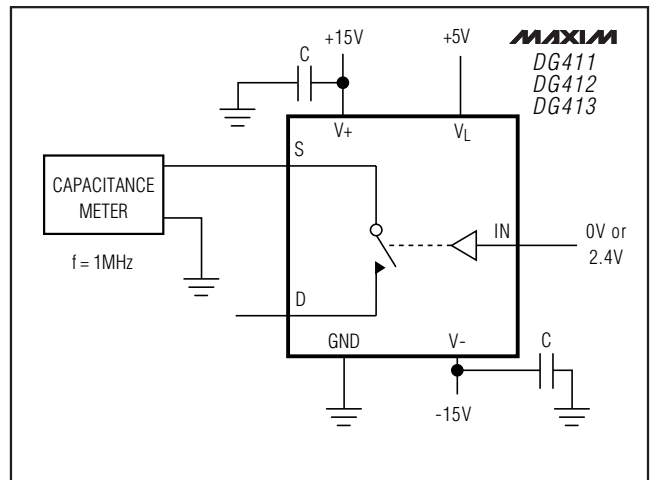

Figure 8. Channel On-Capacitance

Improved, Quad, SPST Analog Switches

DG411/DG412/DG413

Ordering Information (continued)

PART	TEMP RANGE	PIN-PACKAGE
DG411EGE	-40°C to +85°C	16 QFN-EP*
DG411DJ	-40°C to +85°C	16 Plastic DIP
DG411DY	-40°C to +85°C	16 Narrow SO
DG411DK	-40°C to +85°C	16 CERDIP
DG411AK	-55°C to +125°C	16 CERDIP**
DG411MY/PR	-55°C to +125°C	16 SO***
DG411MY/PR-T	-55°C to +125°C	16 SO***
DG412CJ	0°C to +70°C	16 Plastic DIP
DG412CUE	0°C to +70°C	16 TSSOP
DG412EUE	-40°C to +85°C	16 TSSOP
DG412CY	0°C to +70°C	16 Narrow SO
DG412C/D	0°C to +70°C	Dice†
DG412DJ	-40°C to +85°C	16 Plastic DIP
DG412EGE	-40°C to +85°C	16 QFN-EP*
DG412DY	-40°C to +85°C	16 Narrow SO
DG412DK	-40°C to +85°C	16 CERDIP
DG412AK	-55°C to +125°C	16 CERDIP**
DG412MY/PR	-55°C to +125°C	16 SO***
DG412MY/PR-T	-55°C to +125°C	16 SO***
DG413CJ	0°C to +70°C	16 Plastic DIP
DG413CUE	0°C to +70°C	16 TSSOP
DG413EUE	-40°C to +85°C	16 TSSOP
DG413CY	0°C to +70°C	16 Narrow SO
DG413C/D	0°C to +70°C	Dice†
DG413EGE	-40°C to +85°C	16 QFN-EP*
DG413DJ	-40°C to +85°C	16 Plastic DIP
DG413DY	-40°C to +85°C	16 Narrow SO
DG413DK	-40°C to +85°C	16 CERDIP
DG413AK	-55°C to +125°C	16 CERDIP**

†Contact factory for dice specifications.

*EP = Exposed pad.

**Contact factory for availability and processing to MIL-STD-883B.

***Contact factory for availability.

Chip Topography



Improved, Quad, SPST Analog Switches

Pin Configurations/Functional Diagrams (continued)



Improved, Quad, SPST Analog Switches

Package Information

For the latest package outline information and land patterns, go to www.maxim-ic.com/packages.

PACKAGE TYPE	PACKAGE CODE	DOCUMENT NO.
16 QFN-EP	G1655-3	21-0091
16 Plastic DIP	P16-1	21-0043
16 TSSOP	U16-2	21-0066
16 CERDIP	J16-3	21-0045
16 Narrow SO	S16-1	21-0041
16 SO	S16-1	21-0041

DG411/DG412/DG413

Improved, Quad, SPST Analog Switches

Revision History

REVISION NUMBER	REVISION DATE	DESCRIPTION	PAGES CHANGED
6	9/07	Addition of exposed pad information	1, 6, 9, 14, 15
7	9/08	Addition of rugged plastic information	1, 9

Maxim cannot assume responsibility for use of any circuitry other than circuitry entirely embodied in a Maxim product. No circuit patent licenses are implied. Maxim reserves the right to change the circuitry and specifications without notice at any time.

12 **Maxim Integrated Products, 120 San Gabriel Drive, Sunnyvale, CA 94086 408-737-7600**

Looking for pricing, stock, or lifecycle information?

Click below to explore more details on WIN SOURCE:

 [View DG412CY+T on WIN SOURCE](#)

 [Maxim Integrated](#) Information

Optimize Your Supply Chain with WIN SOURCE Solutions

-  Global Sourcing Solution
-  Obsolete Management
-  Cost Control Management
-  Shortage Management
-  Alternative Solution
-  Excess Inventory Management