

## dsPIC30F Flash Programming Specification

### 1.0 OVERVIEW AND SCOPE

This document defines the programming specification for the dsPIC30F family of Digital Signal Controllers (DSCs). The programming specification is required only for the developers of third-party tools that are used to program dsPIC30F devices. Customers using dsPIC30F devices should use development tools that already provide support for device programming.

This document includes programming specifications for the following devices:

- dsPIC30F2010/2011/2012
- dsPIC30F3010/3011/3012/3013/ 3014
- dsPIC30F4011/4012/4013
- dsPIC30F5011/5013/5015/5016
- dsPIC30F6010/6011/6012/6013/6014/6015
- dsPIC30F6010A/6011A/6012A/6013A/6014A

### 2.0 PROGRAMMING OVERVIEW OF THE dsPIC30F

The dsPIC30F family of DSCs contains a region of on-chip memory used to simplify device programming. This region of memory can store a programming executive, which allows the dsPIC30F to be programmed faster than the traditional means. Once the programming executive is stored to memory by an external programmer (such as Microchip's MPLAB<sup>®</sup> ICD 2, MPLAB PM3, PRO MATE<sup>®</sup> II, or MPLAB REAL ICE<sup>™</sup>), it can then interact with the external programmer to efficiently program devices.

The programmer and programming executive have a master-slave relationship, where the programmer is the master programming device and the programming executive is the slave, as illustrated in [Figure 2-1](#).

**FIGURE 2-1: OVERVIEW OF dsPIC30F PROGRAMMING**



Two different methods are used to program the chip in the user's system. One method uses the Enhanced In-Circuit Serial Programming<sup>™</sup> (Enhanced ICSP<sup>™</sup>) protocol and works with the programming executive. The other method uses In-Circuit Serial Programming (ICSP) protocol and does not use the programming executive.

The Enhanced ICSP protocol uses the faster, high-voltage method that takes advantage of the programming executive. The programming executive provides all the necessary functionality to erase, program and verify the chip through a small command set. The command set allows the programmer to program the dsPIC30F without having to deal with the low-level programming protocols of the chip.

The ICSP programming method does not use the programming executive. It provides native, low-level programming capability to erase, program and verify the chip. This method is significantly slower because it uses control codes to serially execute instructions on the dsPIC30F device.

This specification describes the ICSP and Enhanced ICSP programming methods. [Section 3.0 "Programming Executive Application"](#) describes the programming executive application and [Section 5.0 "Device Programming"](#) describes its application programmer's interface for the host programmer. [Section 11.0 "ICSP<sup>™</sup> Mode"](#) describes the ICSP programming method.

#### 2.1 Hardware Requirements

In ICSP or Enhanced ICSP mode, the dsPIC30F requires two programmable power supplies: one for V<sub>DD</sub> and one for MCLR. For Bulk Erase programming, which is required for erasing code protection bits, V<sub>DD</sub> must be greater than 4.5 volts. Refer to [Section 13.0 "AC/DC Characteristics and Timing Requirements"](#) for additional hardware parameters.

# dsPIC30F Flash Programming Specification

## 2.2 Pins Used During Programming

The pins identified in [Table 2-1](#) are used for device programming. Refer to the appropriate device data sheet for complete pin descriptions.

**TABLE 2-1: dsPIC30F PIN DESCRIPTIONS DURING PROGRAMMING**

Pin Name	Pin Type	Pin Description
MCLR/VPP	P	Programming Enable
VDD	P	Power Supply
VSS	P	Ground
PGC	I	Serial Clock
PGD	I/O	Serial Data

**Legend:** I = Input, O = Output, P = Power

## 2.3 Program Memory Map

The program memory space extends from 0x0 to 0xFFFFFE. Code storage is located at the base of the memory map and supports up to 144 Kbytes (48K instruction words). Code is stored in three, 48 Kbyte memory panels that reside on-chip. [Table 2-2](#) shows the location and program memory size of each device.

Locations 0x800000 through 0x8005BE are reserved for executive code memory. This region stores either the programming executive or debugging executive. The programming executive is used for device programming, while the debug executive is used for in-circuit debugging. This region of memory cannot be used to store user code.

Locations 0xF80000 through 0xF8000E are reserved for the Configuration registers. The bits in these registers may be set to select various device options, and are described in [Section 5.7 “Configuration Bits Programming”](#).

Locations 0xFF0000 and 0xFF0002 are reserved for the Device ID registers. These bits can be used by the programmer to identify what device type is being programmed and are described in [Section 10.0 “Device ID”](#). The device ID reads out normally, even after code protection is applied.

[Figure 2-2](#) illustrates the memory map for the dsPIC30F devices.

## 2.4 Data EEPROM Memory

The Data EEPROM array supports up to 4 Kbytes of data and is located in one memory panel. It is mapped in program memory space, residing at the end of User Memory Space (see [Figure 2-2](#)). [Table 2-2](#) shows the location and size of data EEPROM in each device.

**TABLE 2-2: CODE MEMORY AND DATA EEPROM MAP AND SIZE**

Device	Code Memory map (Size in Instruction Words)	Data EEPROM Memory Map (Size in Bytes)
dsPIC30F2010	0x000000-0x001FFE (4K)	0x7FFC00-0x7FFFFE (1K)
dsPIC30F2011	0x000000-0x001FFE (4K)	None (0K)
dsPIC30F2012	0x000000-0x001FFE (4K)	None (0K)
dsPIC30F3010	0x000000-0x003FFE (8K)	0x7FFC00-0x7FFFFE (1K)
dsPIC30F3011	0x000000-0x003FFE (8K)	0x7FFC00-0x7FFFFE (1K)
dsPIC30F3012	0x000000-0x003FFE (8K)	0x7FFC00-0x7FFFFE (1K)
dsPIC30F3013	0x000000-0x003FFE (8K)	0x7FFC00-0x7FFFFE (1K)
dsPIC30F3014	0x000000-0x003FFE (8K)	0x7FFC00-0x7FFFFE (1K)
dsPIC30F4011	0x000000-0x007FFE (16K)	0x7FFC00-0x7FFFFE (1K)
dsPIC30F4012	0x000000-0x007FFE (16K)	0x7FFC00-0x7FFFFE (1K)
dsPIC30F4013	0x000000-0x007FFE (16K)	0x7FFC00-0x7FFFFE (1K)
dsPIC30F5011	0x000000-0x00AFFE (22K)	0x7FFC00-0x7FFFFE (1K)
dsPIC30F5013	0x000000-0x00AFFE (22K)	0x7FFC00-0x7FFFFE (1K)
dsPIC30F5015	0x000000-0x00AFFE (22K)	0x7FFC00-0x7FFFFE (1K)
dsPIC30F5016	0x000000-0x00AFFE (22K)	0x7FFC00-0x7FFFFE (1K)
dsPIC30F6010	0x000000-0x017FFE (48K)	0x7FF000-0x7FFFFE (4K)
dsPIC30F6010A	0x000000-0x017FFE (48K)	0x7FF000-0x7FFFFF (4K)
dsPIC30F6011	0x000000-0x015FFE (44K)	0x7FF800-0x7FFFFE (2K)
dsPIC30F6011A	0x000000-0x015FFE (44K)	0x7FF800-0x7FFFFE (2K)
dsPIC30F6012	0x000000-0x017FFE (48K)	0x7FF000-0x7FFFFE (4K)
dsPIC30F6012A	0x000000-0x017FFE (48K)	0x7FF000-0x7FFFFE (4K)
dsPIC30F6013	0x000000-0x015FFE (44K)	0x7FF800-0x7FFFFE (2K)
dsPIC30F6013A	0x000000-0x015FFE (44K)	0x7FF800-0x7FFFFE (2K)
dsPIC30F6014	0x000000-0x017FFE (48K)	0x7FF000-0x7FFFFE (4K)
dsPIC30F6014A	0x000000-0x017FFE (48K)	0x7FF000-0x7FFFFE (4K)
dsPIC30F6015	0x000000-0x017FFE (48K)	0x7FF000-0x7FFFFE (4K)

# dsPIC30F Flash Programming Specification

FIGURE 2-2: PROGRAM MEMORY MAP



# dsPIC30F Flash Programming Specification

## 3.0 PROGRAMMING EXECUTIVE APPLICATION

### 3.1 Programming Executive Overview

The programming executive resides in executive memory and is executed when Enhanced ICSP Programming mode is entered. The programming executive provides the mechanism for the programmer (host device) to program and verify the dsPIC30F, using a simple command set and communication protocol.

The following capabilities are provided by the programming executive:

- Read memory
  - Code memory and data EEPROM
  - Configuration registers
  - Device ID
- Erase memory
  - Bulk Erase by segment
  - Code memory (by row)
  - Data EEPROM (by row)
- Program memory
  - Code memory
  - Data EEPROM
  - Configuration registers
- Query
  - Blank Device
  - Programming executive software version

The programming executive performs the low-level tasks required for erasing and programming. This allows the programmer to program the device by issuing the appropriate commands and data.

The programming procedure is outlined in [Section 5.0 “Device Programming”](#).

### 3.2 Programming Executive Code Memory

The programming executive is stored in executive code memory and executes from this reserved region of memory. It requires no resources from user code memory or data EEPROM.

### 3.3 Programming Executive Data RAM

The programming executive uses the device’s data RAM for variable storage and program execution. Once the programming executive has run, no assumptions should be made about the contents of data RAM.

## 4.0 CONFIRMING THE CONTENTS OF EXECUTIVE MEMORY

Before programming can begin, the programmer must confirm that the programming executive is stored in executive memory. The procedure for this task is illustrated in [Figure 4-1](#).

First, ICSP mode is entered. The unique application ID word stored in executive memory is then read. If the programming executive is resident, the application ID word is 0xBB, which means programming can resume as normal. However, if the application ID word is not 0xBB, the programming executive must be programmed to Executive Code memory using the method described in [Section 12.0 “Programming the Programming Executive to Memory”](#).

[Section 11.0 “ICSP™ Mode”](#) describes the process for the ICSP programming method. [Section 11.13 “Reading the Application ID Word”](#) describes the procedure for reading the application ID word in ICSP mode.

**FIGURE 4-1: CONFIRMING PRESENCE OF THE PROGRAMMING EXECUTIVE**



# dsPIC30F Flash Programming Specification

## 5.0 DEVICE PROGRAMMING

### 5.1 Overview of the Programming Process

Once the programming executive has been verified in memory (or loaded if not present), the dsPIC30F can be programmed using the command set shown in Table 5-1. A detailed description for each command is provided in Section 8.0 “Programming Executive Commands”.

TABLE 5-1: COMMAND SET SUMMARY

Command	Description
SCHECK	Sanity check
READD	Read data EEPROM, Configuration registers and device ID
READP	Read code memory
PROGD	Program one row of data EEPROM and verify
PROGP	Program one row of code memory and verify
PROGC	Program Configuration bits and verify
ERASEB	Bulk Erase, or erase by segment
ERASED	Erase data EEPROM
ERASEP	Erase code memory
QBLANK	Query if the code memory and data EEPROM are blank
QVER	Query the software version

A high-level overview of the programming process is illustrated in Figure 5-1. The process begins by entering Enhanced ICSP mode. The chip is then bulk erased, which clears all memory to ‘1’ and allows the device to be programmed. The Chip Erase is verified before programming begins. Next, the code memory, data Flash and Configuration bits are programmed. As these memories are programmed, they are each verified to ensure that programming was successful. If no errors are detected, the programming is complete and Enhanced ICSP mode is exited. If any of the verifications fail, the procedure should be repeated, starting from the Chip Erase.

If Advanced Security features are enabled, then individual Segment Erase operations need to be performed, based on user selections (i.e., based on the specific needs of the user application). The specific operations that are used typically depend on the order in which various segments need to be programmed for a given application or system.

Section 5.2 “Entering Enhanced ICSP Mode” through Section 5.8 “Exiting Enhanced ICSP Mode” describe the programming process in detail.

FIGURE 5-1: PROGRAMMING FLOW



# dsPIC30F Flash Programming Specification

## 5.2 Entering Enhanced ICSP Mode

The Enhanced ICSP mode is entered by holding PGC and PGD high, and then raising MCLR/VPP to VIH (high voltage), as illustrated in Figure 5-2. In this mode, the code memory, data EEPROM and Configuration bits can be efficiently programmed using the programming executive commands that are serially transferred using PGC and PGD.

**FIGURE 5-2: ENTERING ENHANCED ICSP™ MODE**



**Note 1:** The sequence that places the device into Enhanced ICSP mode places all unused I/Os in the high-impedance state.

**2:** Before entering Enhanced ICSP mode, clock switching must be disabled using ICSP, by programming the FCKSM<1:0> bits in the FOSC Configuration register to '11' or '10'.

**3:** When in Enhanced ICSP mode, the SPI output pin (SDO1) will toggle while the device is being programmed.

## 5.3 Chip Erase

Before a chip can be programmed, it must be erased. The Bulk Erase command (ERASEB) is used to perform this task. Executing this command with the MS command field set to 0x3 erases all code memory, data EEPROM and code-protect Configuration bits. The Chip Erase process sets all bits in these three memory regions to '1'.

Since non-code-protect Configuration bits cannot be erased, they must be manually set to '1' using multiple PROGC commands. One PROGC command must be sent for each Configuration register (see Section 5.7 "Configuration Bits Programming").

If Advanced Security features are enabled, then individual Segment Erase operations would need to be performed, depending on which segment needs to be programmed at a given stage of system programming. The user should have the flexibility to select specific segments for programming.

**Note:** The Device ID registers cannot be erased. These registers remain intact after a Chip Erase is performed.

## 5.4 Blank Check

The term "Blank Check" means to verify that the device has been successfully erased and has no programmed memory cells. A blank or erased memory cell reads as '1'. The following memories must be blank checked:

- All implemented code memory
- All implemented data EEPROM
- All Configuration bits (for their default value)

The Device ID registers (0xFF0000:0xFF0002) can be ignored by the Blank Check since this region stores device information that cannot be erased. Additionally, all unimplemented memory space should be ignored from the Blank Check.

The QBLANK command is used for the Blank Check. It determines if the code memory and data EEPROM are erased by testing these memory regions. A 'BLANK' or 'NOT BLANK' response is returned. The READD command is used to read the Configuration registers. If it is determined that the device is not blank, it must be erased (see Section 5.3 "Chip Erase") before attempting to program the chip.

# dsPIC30F Flash Programming Specification

## 5.5 Code Memory Programming

### 5.5.1 OVERVIEW

The Flash code memory array consists of 512 rows of thirty-two, 24-bit instructions. Each panel stores 16K instruction words, and each dsPIC30F device has either 1, 2 or 3 memory panels (see [Table 5-2](#)).

**TABLE 5-2: DEVICE CODE MEMORY SIZE**

Device	Code Size (24-bit Words)	Number of Rows	Number of Panels
dsPIC30F2010	4K	128	1
dsPIC30F2011	4K	128	1
dsPIC30F2012	4K	128	1
dsPIC30F3010	8K	256	1
dsPIC30F3011	8K	256	1
dsPIC30F3012	8K	256	1
dsPIC30F3013	8K	256	1
dsPIC30F3014	8K	256	1
dsPIC30F4011	16K	512	1
dsPIC30F4012	16K	512	1
dsPIC30F4013	16K	512	1
dsPIC30F5011	22K	704	2
dsPIC30F5013	22K	704	2
dsPIC30F5015	22K	704	2
dsPIC30F5016	22K	704	2
dsPIC30F6010	48K	1536	3
dsPIC30F6010A	48K	1536	3
dsPIC30F6011	44K	1408	3
dsPIC30F6011A	44K	1408	3
dsPIC30F6012	48K	1536	3
dsPIC30F6012A	48K	1536	3
dsPIC30F6013	44K	1408	3
dsPIC30F6013A	44K	1408	3
dsPIC30F6014	48K	1536	3
dsPIC30F6014A	48K	1536	3
dsPIC30F6015	48K	1536	3

### 5.5.2 PROGRAMMING METHODOLOGY

Code memory is programmed with the `PROGP` command. `PROGP` programs one row of code memory to the memory address specified in the command. The number of `PROGP` commands required to program a device depends on the number of rows that must be programmed in the device.

A flowchart for programming of code memory is illustrated in [Figure 5-3](#). In this example, all 48K instruction words of a dsPIC30F6014A device are programmed. First, the number of commands to send (called 'RemainingCmds' in the flowchart) is set to 1536 and the destination address (called 'BaseAddress') is set to '0'.

Next, one row in the device is programmed with a `PROGP` command. Each `PROGP` command contains data for one row of code memory of the dsPIC30F6014A. After the first command is processed successfully, 'RemainingCmds' is decremented by 1 and compared to 0. Since there are more `PROGP` commands to send, 'BaseAddress' is incremented by 0x40 to point to the next row of memory.

On the second `PROGP` command, the second row of each memory panel is programmed. This process is repeated until the entire device is programmed. No special handling must be performed when a panel boundary is crossed.

**FIGURE 5-3: FLOWCHART FOR PROGRAMMING dsPIC30F6014A CODE MEMORY**



# dsPIC30F Flash Programming Specification

## 5.5.3 PROGRAMMING VERIFICATION

Once code memory is programmed, the contents of memory can be verified to ensure that programming was successful. Verification requires code memory to be read back and compared against the copy held in the programmer's buffer.

The `READP` command can be used to read back all the programmed code memory.

Alternatively, you can have the programmer perform the verification once the entire device is programmed using a checksum computation, as described in [Section 6.8 "Checksum Computation"](#).

## 5.6 Data EEPROM Programming

### 5.6.1 OVERVIEW

The panel architecture for the data EEPROM memory array consists of 128 rows of sixteen 16-bit data words. Each panel stores 2K words. All devices have either one or no memory panels. Devices with data EEPROM provide either 512 words, 1024 words or 2048 words of memory on the one panel (see [Table 5-3](#)).

**TABLE 5-3: DATA EEPROM SIZE**

Device	Data EEPROM Size (Words)	Number of Rows
dsPIC30F2010	512	32
dsPIC30F2011	0	0
dsPIC30F2012	0	0
dsPIC30F3010	512	32
dsPIC30F3011	512	32
dsPIC30F3012	512	32
dsPIC30F3013	512	32
dsPIC30F3014	512	32
dsPIC30F4011	512	32
dsPIC30F4012	512	32
dsPIC30F4013	512	32
dsPIC30F5011	512	32
dsPIC30F5013	512	32
dsPIC30F5015	512	32
dsPIC30F5016	512	32
dsPIC30F6010	2048	128
dsPIC30F6010A	2048	128
dsPIC30F6011	1024	64
dsPIC30F6011A	1024	64
dsPIC30F6012	2048	128
dsPIC30F6012A	2048	128
dsPIC30F6013	1024	64
dsPIC30F6013A	1024	64
dsPIC30F6014	2048	128
dsPIC30F6014A	2048	128
dsPIC30F6015	2048	128

## 5.6.2 PROGRAMMING METHODOLOGY

The programming executive uses the `PROGD` command to program the data EEPROM. [Figure 5-4](#) illustrates the flowchart of the process. Firstly, the number of rows to program (`RemainingRows`) is based on the device size, and the destination address (`DestAddress`) is set to '0'. In this example, 128 rows (2048 words) of data EEPROM will be programmed.

The first `PROGD` command programs the first row of data EEPROM. Once the command completes successfully, '`RemainingRows`' is decremented by 1 and compared with 0. Since there are 127 more rows to program, '`BaseAddress`' is incremented by `0x20` to point to the next row of data EEPROM. This process is then repeated until all 128 rows of data EEPROM are programmed.

**FIGURE 5-4: FLOWCHART FOR PROGRAMMING dsPIC30F6014A DATA EEPROM**

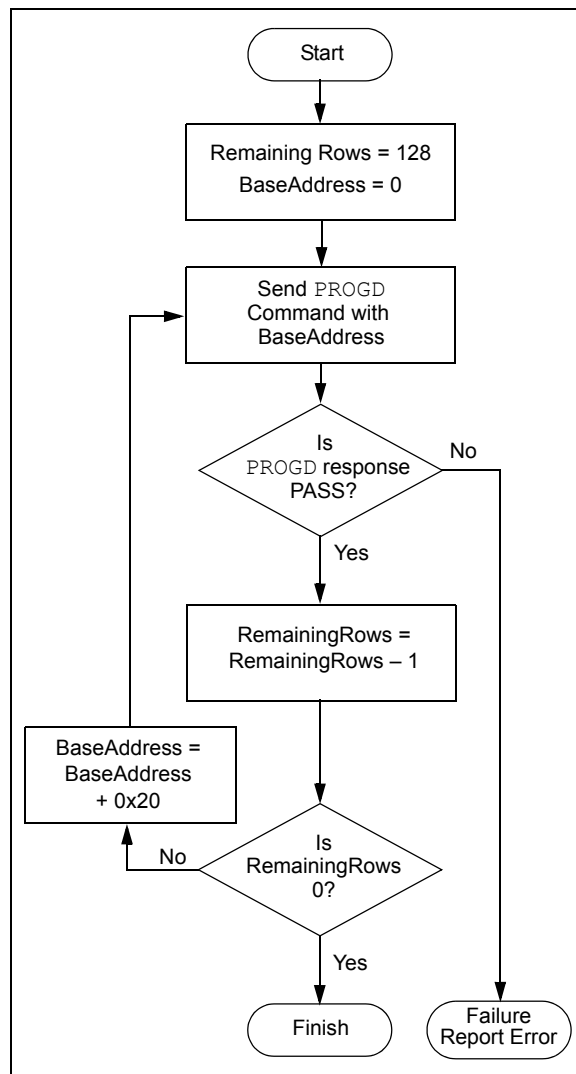

# dsPIC30F Flash Programming Specification

## 5.6.3 PROGRAMMING VERIFICATION

Once the data EEPROM is programmed, the contents of memory can be verified to ensure that the programming was successful. Verification requires the data EEPROM to be read back and compared against the copy held in the programmer's buffer. The READD command reads back the programmed data EEPROM.

Alternatively, the programmer can perform the verification once the entire device is programmed using a checksum computation, as described in [Section 6.8 "Checksum Computation"](#).

**Note:** TBLRDL instructions executed within a REPEAT loop must not be used to read from Data EEPROM. Instead, it is recommended to use PSV access.

## 5.7 Configuration Bits Programming

### 5.7.1 OVERVIEW

The dsPIC30F has Configuration bits stored in seven 16-bit registers. These bits can be set or cleared to select various device configurations. There are two types of Configuration bits: system-operation bits and code-protect bits. The system-operation bits determine the power-on settings for system-level components such as the oscillator and Watchdog Timer. The code-protect bits prevent program memory from being read and written.

The FOSC Configuration register has three different register descriptions, based on the device. The FOSC Configuration register description for the dsPIC30F2010 and dsPIC30F6010/6011/6012/6013/6014 devices are shown in [Table 5-4](#).

**Note:** If user software performs an erase operation on the configuration fuse, it must be followed by a write operation to this fuse with the desired value, even if the desired value is the same as the state of the erased fuse.

The FOSC Configuration register description for the dsPIC30F4011/4012 and dsPIC30F5011/5013 devices is shown in [Table 5-5](#).

The FOSC Configuration register description for all remaining devices (dsPIC30F2011/2012, dsPIC30F3010/3011/3012/3013, dsPIC30F3014/4013, dsPIC30F5015 and dsPIC30F6011A/6012A/6013A/6014A) is shown in [Table 5-6](#). Always use the correct register descriptions for your target processor.

The FWDT, FBORPOR, FBS, FSS, FGS and FICD Configuration registers are not device-dependent. The register descriptions for these Configuration registers are shown in [Table 5-7](#).

The Device Configuration register maps are shown in [Table 5-8](#) through [Table 5-11](#).

**TABLE 5-4: FOSC CONFIGURATION BITS DESCRIPTION FOR dsPIC30F2010 AND dsPIC30F6010/6011/6012/6013/6014**

Bit Field	Register	Description
FCKSM<1:0>	FOSC	<b>Clock Switching Mode</b> 1x = Clock switching is disabled, Fail-Safe Clock Monitor is disabled 01 = Clock switching is enabled, Fail-Safe Clock Monitor is disabled 00 = Clock switching is enabled, Fail-Safe Clock Monitor is enabled
FOS<1:0>	FOSC	<b>Oscillator Source Selection on POR</b> 11 = Primary Oscillator 10 = Internal Low-Power RC Oscillator 01 = Internal Fast RC Oscillator 00 = Low-Power 32 kHz Oscillator (Timer1 Oscillator)
FPR<3:0>	FOSC	<b>Primary Oscillator Mode</b> 1111 = ECIO w/PLL 16X – External Clock mode with 16X PLL. OSC2 pin is I/O 1110 = ECIO w/PLL 8X – External Clock mode with 8X PLL. OSC2 pin is I/O 1101 = ECIO w/PLL 4X – External Clock mode with 4X PLL. OSC2 pin is I/O 1100 = ECIO – External Clock mode. OSC2 pin is I/O 1011 = EC – External Clock mode. OSC2 pin is system clock output (Fosc/4) 1010 = Reserved (do not use) 1001 = ERC – External RC Oscillator mode. OSC2 pin is system clock output (Fosc/4) 1000 = ERCIO – External RC Oscillator mode. OSC2 pin is I/O 0111 = XT w/PLL 16X – XT Crystal Oscillator mode with 16X PLL 0110 = XT w/PLL 8X – XT Crystal Oscillator mode with 8X PLL 0101 = XT w/PLL 4X – XT Crystal Oscillator mode with 4X PLL 0100 = XT – XT Crystal Oscillator mode (4 MHz-10 MHz crystal) 001x = HS – HS Crystal Oscillator mode (10 MHz-25 MHz crystal) 000x = XTL – XTL Crystal Oscillator mode (200 kHz-4 MHz crystal)

# dsPIC30F Flash Programming Specification

**TABLE 5-5: FOSC CONFIGURATION BITS DESCRIPTION FOR dsPIC30F4011/4012 AND dsPIC30F5011/5013**

Bit Field	Register	Description
FCKSM<1:0>	FOSC	<b>Clock Switching Mode</b> 1x = Clock switching is disabled, Fail-Safe Clock Monitor is disabled 01 = Clock switching is enabled, Fail-Safe Clock Monitor is disabled 00 = Clock switching is enabled, Fail-Safe Clock Monitor is enabled
FOS<1:0>	FOSC	<b>Oscillator Source Selection on POR</b> 11 = Primary Oscillator 10 = Internal Low-Power RC Oscillator 01 = Internal Fast RC Oscillator 00 = Low-Power 32 kHz Oscillator (Timer1 Oscillator)
FPR<3:0>	FOSC	<b>Primary Oscillator Mode</b> 1111 = ECIO w/PLL 16X – External Clock mode with 16X PLL. OSC2 pin is I/O 1110 = ECIO w/PLL 8X – External Clock mode with 8X PLL. OSC2 pin is I/O 1101 = ECIO w/PLL 4X – External Clock mode with 4X PLL. OSC2 pin is I/O 1100 = ECIO – External Clock mode. OSC2 pin is I/O 1011 = EC – External Clock mode. OSC2 pin is system clock output (Fosc/4) 1010 = FRC w/PLL 8x – Internal fast RC oscillator with 8x PLL. OSC2 pin is I/O 1001 = ERC – External RC Oscillator mode. OSC2 pin is system clock output (Fosc/4) 1000 = ERCIO – External RC Oscillator mode. OSC2 pin is I/O 0111 = XT w/PLL 16X – XT Crystal Oscillator mode with 16X PLL 0110 = XT w/PLL 8X – XT Crystal Oscillator mode with 8X PLL 0101 = XT w/PLL 4X – XT Crystal Oscillator mode with 4X PLL 0100 = XT – XT Crystal Oscillator mode (4 MHz-10 MHz crystal) 0011 = FRC w/PLL 16x – Internal fast RC oscillator with 16x PLL. OSC2 pin is I/O 0010 = HS – HS Crystal Oscillator mode (10 MHz-25 MHz crystal) 0001 = FRC w/PLL 4x – Internal fast RC oscillator with 4x PLL. OSC2 pin is I/O 0000 = XTL – XTL Crystal Oscillator mode (200 kHz-4 MHz crystal)

# dsPIC30F Flash Programming Specification

**TABLE 5-6: FOSC CONFIGURATION BITS DESCRIPTION FOR dsPIC30F2011/2012, dsPIC30F3010/3011/3012/3013/3014, dsPIC30F4013, dsPIC30F5015/5016, dsPIC30F6010A/6011A/6012A/6013A/6014A AND dsPIC30F6015**

Bit Field	Register	Description
FCKSM<1:0>	FOSC	<b>Clock Switching Mode</b> 1x = Clock switching is disabled, Fail-Safe Clock Monitor is disabled 01 = Clock switching is enabled, Fail-Safe Clock Monitor is disabled 00 = Clock switching is enabled, Fail-Safe Clock Monitor is enabled
FOS<2:0>	FOSC	<b>Oscillator Source Selection on POR</b> 111 = Primary Oscillator 110 = Reserved 101 = Reserved 100 = Reserved 011 = Reserved 010 = Internal Low-Power RC Oscillator 001 = Internal Fast RC Oscillator (no PLL) 000 = Low-Power 32 kHz Oscillator (Timer1 Oscillator)
FPR<4:0>	FOSC	<b>Primary Oscillator Mode (when FOS&lt;2:0&gt; = 111b)</b> 11xxx = Reserved (do not use) 10111 = HS/3 w/PLL 16X – HS/3 crystal oscillator with 16X PLL (10 MHz-25 MHz crystal) 10110 = HS/3 w/PLL 8X – HS/3 crystal oscillator with 8X PLL (10 MHz-25 MHz crystal) 10101 = HS/3 w/PLL 4X – HS/3 crystal oscillator with 4X PLL (10 MHz-25 MHz crystal) 10100 = Reserved (do not use) 10011 = HS/2 w/PLL 16X – HS/2 crystal oscillator with 16X PLL (10 MHz-25 MHz crystal) 10010 = HS/2 w/PLL 8X – HS/2 crystal oscillator with 8X PLL (10 MHz-25 MHz crystal) 10001 = HS/2 w/PLL 4X – HS/2 crystal oscillator with 4X PLL (10 MHz-25 MHz crystal) 10000 = Reserved (do not use) 01111 = ECIO w/PLL 16x – External clock with 16x PLL. OSC2 pin is I/O 01110 = ECIO w/PLL 8x – External clock with 8x PLL. OSC2 pin is I/O 01101 = ECIO w/PLL 4x – External clock with 4x PLL. OSC2 pin is I/O 01100 = Reserved (do not use) 01011 = Reserved (do not use) 01010 = FRC w/PLL 8x – Internal fast RC oscillator with 8x PLL. OSC2 pin is I/O 01001 = Reserved (do not use) 01000 = Reserved (do not use) 00111 = XT w/PLL 16X – XT crystal oscillator with 16X PLL 00110 = XT w/PLL 8X – XT crystal oscillator with 8X PLL 00101 = XT w/PLL 4X – XT crystal oscillator with 4X PLL 00100 = Reserved (do not use) 00011 = FRC w/PLL 16x – Internal fast RC oscillator with 8x PLL. OSC2 pin is I/O 00010 = Reserved (do not use) 00001 = FRC w/PLL 4x – Internal fast RC oscillator with 4x PLL. OSC2 pin is I/O 00000 = Reserved (do not use)

# dsPIC30F Flash Programming Specification

**TABLE 5-6: FOSC CONFIGURATION BITS DESCRIPTION FOR dsPIC30F2011/2012, dsPIC30F3010/3011/3012/3013/3014, dsPIC30F4013, dsPIC30F5015/5016, dsPIC30F6010A/6011A/6012A/6013A/6014A AND dsPIC30F6015 (CONTINUED)**

Bit Field	Register	Description
FPR<4:0>	FOSC	<b>Alternate Oscillator Mode (when FOS&lt;2:0&gt; = 011b)</b> 1xxxx = Reserved (do not use) 0111x = Reserved (do not use) 01101 = Reserved (do not use) 01100 = ECIO – External clock. OSC2 pin is I/O 01011 = EC – External clock. OSC2 pin is system clock output (Fosc/4) 01010 = Reserved (do not use) 01001 = ERC – External RC oscillator. OSC2 pin is system clock output (Fosc/4) 01000 = ERCIO – External RC oscillator. OSC2 pin is I/O 00111 = Reserved (do not use) 00110 = Reserved (do not use) 00101 = Reserved (do not use) 00100 = XT – XT crystal oscillator (4 MHz-10 MHz crystal) 00010 = HS – HS crystal oscillator (10 MHz-25 MHz crystal) 00001 = Reserved (do not use) 00000 = XTL – XTL crystal oscillator (200 kHz-4 MHz crystal)

# dsPIC30F Flash Programming Specification

**TABLE 5-7: CONFIGURATION BITS DESCRIPTION**

Bit Field	Register	Description
FWPSA<1:0>	FWDT	<b>Watchdog Timer Prescaler A</b> 11 = 1:512 10 = 1:64 01 = 1:8 00 = 1:1
FWPSB<3:0>	FWDT	<b>Watchdog Timer Prescaler B</b> 1111 = 1:16 1110 = 1:15 . . . 0001 = 1:2 0000 = 1:1
FWDTEN	FWDT	<b>Watchdog Enable</b> 1 = Watchdog enabled (LPRC oscillator cannot be disabled. Clearing the SWDTEN bit in the RCON register will have no effect) 0 = Watchdog disabled (LPRC oscillator can be disabled by clearing the SWDTEN bit in the RCON register)
MCLREN	FBORPOR	<b>Master Clear Enable</b> 1 = Master Clear pin (MCLR) is enabled 0 = MCLR pin is disabled
PWMPIN	FBORPOR	<b>Motor Control PWM Module Pin Mode</b> 1 = PWM module pins controlled by PORT register at device Reset (tri-stated) 0 = PWM module pins controlled by PWM module at device Reset (configured as output pins)
HPOL	FBORPOR	<b>Motor Control PWM Module High-Side Polarity</b> 1 = PWM module high-side output pins have active-high output polarity 0 = PWM module high-side output pins have active-low output polarity
LPOL	FBORPOR	<b>Motor Control PWM Module Low-Side Polarity</b> 1 = PWM module low-side output pins have active-high output polarity 0 = PWM module low-side output pins have active-low output polarity
BOREN	FBORPOR	<b>PBOR Enable</b> 1 = PBOR enabled 0 = PBOR disabled
BORV<1:0>	FBORPOR	<b>Brown-out Voltage Select</b> 11 = 2.0V (not a valid operating selection) 10 = 2.7V 01 = 4.2V 00 = 4.5V
FPWRT<1:0>	FBORPOR	<b>Power-on Reset Timer Value Select</b> 11 = PWRT = 64 ms 10 = PWRT = 16 ms 01 = PWRT = 4 ms 00 = Power-up Timer disabled
RBS<1:0>	FBS	<b>Boot Segment Data RAM Code Protection (only present in dsPIC30F5011/5013/6010A/6011A/6012A/6013A/6014A/6015)</b> 11 = No Data RAM is reserved for Boot Segment 10 = Small-sized Boot RAM [128 bytes of RAM are reserved for Boot Segment] 01 = Medium-sized Boot RAM [256 bytes of RAM are reserved for Boot Segment] 00 = Large-sized Boot RAM [512 bytes of RAM are reserved for Boot Segment in dsPIC30F5011/5013, and 1024 bytes in dsPIC30F6010A/6011A/6012A/6013A/6014A/6015]

# dsPIC30F Flash Programming Specification

**TABLE 5-7: CONFIGURATION BITS DESCRIPTION (CONTINUED)**

Bit Field	Register	Description
EBS	FBS	<p><b>Boot Segment Data EEPROM Code Protection (only present in dsPIC30F5011/5013/6010A/6011A/6012A/6013A/6014A/6015)</b></p> <p>1 = No Data EEPROM is reserved for Boot Segment            0 = 128 bytes of Data EEPROM are reserved for Boot Segment in dsPIC30F5011/5013, and 256 bytes in dsPIC30F6010A/6011A/6012A/6013A/6014A/6015</p>
BSS<2:0>	FBS	<p><b>Boot Segment Program Memory Code Protection (only present in dsPIC30F5011/5013/6010A/6011A/6012A/6013A/6014A/6015)</b></p> <p>111 = No Boot Segment            110 = Standard security; Small-sized Boot Program Flash            [Boot Segment starts after BS and ends at 0x0003FF]            101 = Standard security; Medium-sized Boot Program Flash            [Boot Segment starts after BS and ends at 0x000FFF]            100 = Standard security; Large-sized Boot Program Flash            [Boot Segment starts after BS and ends at 0x001FFF]            011 = No Boot Segment            010 = High security; Small-sized Boot Program Flash            [Boot Segment starts after BS and ends at 0x0003FF]            001 = High security; Medium-sized Boot Program Flash            [Boot Segment starts after BS and ends at 0x000FFF]            000 = High security; Large-sized Boot Program Flash            [Boot Segment starts after BS and ends at 0x001FFF]</p>
BWRP	FBS	<p><b>Boot Segment Program Memory Write Protection (only present in dsPIC30F5011/5013/6010A/6011A/6012A/6013A/6014A/6015)</b></p> <p>1 = Boot Segment program memory is not write-protected            0 = Boot Segment program memory is write-protected</p>
RSS<1:0>	FSS	<p><b>Secure Segment Data RAM Code Protection (only present in dsPIC30F5011/5013/6010A/6011A/6012A/6013A/6014A/6015)</b></p> <p>11 = No Data RAM is reserved for Secure Segment            10 = Small-sized Secure RAM            [(256 – N) bytes of RAM are reserved for Secure Segment]            01 = Medium-sized Secure RAM            [(768 – N) bytes of RAM are reserved for Secure Segment in dsPIC30F5011/5013, and (2048 – N) bytes in dsPIC30F6010A/6011A/6012A/6013A/6014A/6015]            00 = Large-sized Secure RAM            [(1024 – N) bytes of RAM are reserved for Secure Segment in dsPIC30F5011/5013, and (4096 – N) bytes in dsPIC30F6010A/6011A/6012A/6013A/6014A/6015]            where N = Number of bytes of RAM reserved for Boot Sector.</p>
ESS<1:0>	FSS	<p><b>Secure Segment Data EEPROM Code Protection (only present in dsPIC30F5011/5013/6010A/6011A/6012A/6013A/6014A/6015)</b></p> <p>11 = No Data EEPROM is reserved for Secure Segment            10 = Small-sized Secure Data EEPROM            [(128 – N) bytes of Data EEPROM are reserved for Secure Segment in dsPIC30F5011/5013, and (256 – N) bytes in dsPIC30F6010A/6011A/6012A/6013A/6014A/6015]            01 = Medium-sized Secure Data EEPROM            [(256 – N) bytes of Data EEPROM are reserved for Secure Segment in dsPIC30F5011/5013, and (512 – N) bytes in dsPIC30F6010A/6011A/6012A/6013A/6014A/6015]            00 = Large-sized Secure Data EEPROM            [(512 – N) bytes of Data EEPROM are reserved for Secure Segment in dsPIC30F5011/5013, (1024 – N) bytes in dsPIC30F6011A/6013A, and (2048 – N) bytes in dsPIC30F6010A/6012A/6014A/6015]            where N = Number of bytes of Data EEPROM reserved for Boot Sector.</p>

# dsPIC30F Flash Programming Specification

**TABLE 5-7: CONFIGURATION BITS DESCRIPTION (CONTINUED)**

Bit Field	Register	Description
SSS<2:0>	FSS	<b>Secure Segment Program Memory Code Protection (only present in dsPIC30F5011/5013/6010A/6011A/6012A/6013A/6014A/6015)</b> 111 = No Secure Segment 110 = Standard security; Small-sized Secure Program Flash [Secure Segment starts after BS and ends at 0x001FFF] 101 = Standard security; Medium-sized Secure Program Flash [Secure Segment starts after BS and ends at 0x003FFF] 100 = Standard security; Large-sized Secure Program Flash [Secure Segment starts after BS and ends at 0x007FFF] 011 = No Secure Segment 010 = High security; Small-sized Secure Program Flash [Secure Segment starts after BS and ends at 0x001FFF] 001 = High security; Medium-sized Secure Program Flash [Secure Segment starts after BS and ends at 0x003FFF] 000 = High security; Large-sized Secure Program Flash [Secure Segment starts after BS and ends at 0x007FFF]
SWRP	FSS	<b>Secure Segment Program Memory Write Protection (only present in dsPIC30F5011/5013/6010A/6011A/6012A/6013A/6014A/6015)</b> 1 = Secure Segment program memory is not write-protected 0 = Secure program memory is write-protected
GSS<1:0>	FGS	<b>General Segment Program Memory Code Protection (only present in dsPIC30F5011/5013/6010A/6011A/6012A/6013A/6014A/6015)</b> 11 = Code protection is disabled 10 = Standard security code protection is enabled 0x = High security code protection is enabled
GCP	FGS	<b>General Segment Program Memory Code Protection (present in all devices except dsPIC30F5011/5013/6010A/6011A/6012A/6013A/6014A/6015)</b> 1 = General Segment program memory is not code-protected 0 = General Segment program memory is code-protected
GWRP	FGS	<b>General Segment Program Memory Write Protection</b> 1 = General Segment program memory is not write-protected 0 = General Segment program memory is write-protected
BKBUG	FICD	<b>Debugger/Emulator Enable</b> 1 = Device will reset into Operational mode 0 = Device will reset into Debug/Emulation mode
COE	FICD	<b>Debugger/Emulator Enable</b> 1 = Device will reset into Operational mode 0 = Device will reset into Clip-on Emulation mode
ICS<1:0>	FICD	<b>ICD Communication Channel Select</b> 11 = Communicate on PGC/EMUC and PGD/EMUD 10 = Communicate on EMUC1 and EMUD1 01 = Communicate on EMUC2 and EMUD2 00 = Communicate on EMUC3 and EMUD3
RESERVED	FBS, FSS, FGS	<b>Reserved (read as '1', write as '1')</b>
—	All	<b>Unimplemented (read as '0', write as '0')</b>

**TABLE 5-8: dsPIC30F CONFIGURATION REGISTERS (FOR dsPIC30F2010, dsPIC30F4011/4012 AND dsPIC30F6016014)**

Address	Name	Bit 15	Bit 14	Bit 13	Bit 12	Bit 11	Bit 10	Bit 9	Bit 8	Bit 7	Bit 6	Bit 5	Bit 4	Bit 3
0xF80000	FOSC	FCKSM<1:0>		—	—	—	—	FOS<1:0>	—	—	—	—	—	—
0xF80002	FWDTE	FWDTEN	—	—	—	—	—	—	—	—	—	FWPSA<1:0>		
0xF80004	FBORPOR	MCLREN	—	—	—	—	PWMPIN <sup>(1)</sup>	HPOL <sup>(1)</sup>	LPOL <sup>(1)</sup>	BOREN	—	BORV<1:0>		
0xF80006	FBS	—	—	Reserved <sup>(2)</sup>	—	—	—	—	Reserved <sup>(2)</sup>	—	—	—		
0xF80008	FSS	—	—	Reserved <sup>(2)</sup>	—	—	—	Reserved <sup>(2)</sup>	—	—	—	—		
0xF8000A	FGS	—	—	—	—	—	—	—	—	—	—	—		
0xF8000C	FICD	BKBUG	COE	—	—	—	—	—	—	—	—	—		

**Note 1:** On the 6011, 6012, 6013 and 6014, these bits are reserved (read as '1' and must be programmed as '1').

**2:** Reserved bits read as '1' and must be programmed as '1'.

**TABLE 5-9: dsPIC30F CONFIGURATION REGISTERS (FOR dsPIC30F5011/5013)**

Address	Name	Bit 15	Bit 14	Bit 13	Bit 12	Bit 11	Bit 10	Bit 9	Bit 8	Bit 7	Bit 6	Bit 5	Bit 4	Bit 3
0xF80000	FOSC	FCKSM<1:0>		—	—	—	—	FOS<1:0>	—	—	—	—	—	—
0xF80002	FWDTE	FWDTEN	—	—	—	—	—	—	—	—	—	FWPSA<1:0>		
0xF80004	FBORPOR	MCLREN	—	—	—	—	—	Reserved <sup>(1)</sup>	—	BOREN	—	BORV<1:0>		
0xF80006	FBS	—	—	RBS<1:0>	—	—	—	—	EBS	—	—	—		
0xF80008	FSS	—	—	RSS<1:0>	—	—	—	ESS<1:0>	—	—	—	—		
0xF8000A	FGS	—	—	—	—	—	—	—	—	—	—	—		
0xF8000C	FICD	BKBUG	COE	—	—	—	—	—	—	—	—	—		

**Note 1:** Reserved bits read as '1' and must be programmed as '1'.

**TABLE 5-10: dsPIC30F CONFIGURATION REGISTERS (FOR dsPIC30F2011/2012, dsPIC30F3010/3011/3012/3013/3016)  
dsPIC30F5015/5016)**

Address	Name	Bit 15	Bit 14	Bit 13	Bit 12	Bit 11	Bit 10	Bit 9	Bit 8	Bit 7	Bit 6	Bit 5	Bit 4	Bit 3
0xF80000	FOSC	FCKSM<1:0>		—	—	—	FOS<2:0>		—	—	—	—	—	—
0xF80002	FWDT	FWDTEN	—	—	—	—	—	—	—	—	—	FWPSA<1:0>		
0xF80004	FBORPOR	MCLREN	—	—	—	PWMPIN(1)	HPOL(1)	HPOL(1)	LPOL(1)	BOREN	—	BORV<1:0>		
0xF80006	FBS	—	—	Reserved(2)	—	—	—	—	Reserved(2)	—	—	—		
0xF80008	FSS	—	—	Reserved(2)	—	—	—	Reserved(2)	—	—	—	—		
0xF8000A	FGS	—	—	—	—	—	—	—	—	—	—	—		
0xF8000C	FICD	BKBUG	COE	—	—	—	—	—	—	—	—	—		

**Note 1:** On the 2011, 2012, 3012, 3013, 3014 and 4013, these bits are reserved (read as '1' and must be programmed as '1').

**2:** Reserved bits read as '1' and must be programmed as '1'.

**3:** The FGS<2> bit is a read-only copy of the GCP bit (FGS<1>).

**TABLE 5-11: dsPIC30F CONFIGURATION REGISTERS (FOR dsPIC30F6010A/6011A/6012A/6013A/6014A AND dsPIC30F6015A/6016A)**

Address	Name	Bit 15	Bit 14	Bit 13	Bit 12	Bit 11	Bit 10	Bit 9	Bit 8	Bit 7	Bit 6	Bit 5	Bit 4	Bit 3
0xF80000	FOSC	FCKSM<1:0>		—	—	—	FOS<2:0>		—	—	—	—	—	—
0xF80002	FWDT	FWDTEN	—	—	—	—	—	—	—	—	—	FWPSA<1:0>		
0xF80004	FBORPOR	MCLREN	—	—	—	PWMPIN(1)	HPOL(1)	HPOL(1)	LPOL(1)	BOREN	—	BORV<1:0>		
0xF80006	FBS	—	—	RBS<1:0>	—	—	—	—	EBS	—	—	—		
0xF80008	FSS	—	—	RSS<1:0>	—	—	—	ESS<1:0>	—	—	—	—		
0xF8000A	FGS	—	—	—	—	—	—	—	—	—	—	—		
0xF8000C	FICD	BKBUG	COE	—	—	—	—	—	—	—	—	—		

**Note 1:** On the 6011A, 6012A, 6013A and 6014A, these bits are reserved (read as '1' and must be programmed as '1').

# dsPIC30F Flash Programming Specification

## 5.7.2 PROGRAMMING METHODOLOGY

System operation Configuration bits are inherently different than all other memory cells. Unlike code memory, data EEPROM and code-protect Configuration bits, the system operation bits cannot be erased. If the chip is erased with the `ERASEB` command, the system-operation bits retain their previous value. Consequently, you should make no assumption about the value of the system operation bits. They should always be programmed to their desired setting.

Configuration bits are programmed as a single word at a time using the `PROGC` command. The `PROGC` command specifies the configuration data and Configuration register address. When Configuration bits are programmed, any unimplemented bits must be programmed with a '0', and any reserved bits must be programmed with a '1'.

Four `PROGC` commands are required to program all the Configuration bits. [Figure 5-5](#) illustrates the flowchart of Configuration bit programming.

**Note:** If the General Code Segment Code Protect (GCP) bit is programmed to '0', code memory is code-protected and cannot be read. Code memory must be verified before enabling read protection. See [Section 5.7.4 "Code-Protect Configuration Bits"](#) for more information about code-protect Configuration bits.

## 5.7.3 PROGRAMMING VERIFICATION

Once the Configuration bits are programmed, the contents of memory should be verified to ensure that the programming was successful. Verification requires the Configuration bits to be read back and compared against the copy held in the programmer's buffer. The `READD` command reads back the programmed Configuration bits and verifies whether the programming was successful.

Any unimplemented Configuration bits are read-only and read as '0'.

## 5.7.4 CODE-PROTECT CONFIGURATION BITS

The FBS, FSS and FGS Configuration registers are special Configuration registers that control the size and level of code protection for the Boot Segment, Secure Segment and General Segment, respectively. For each segment, two main forms of code protection are provided. One form prevents code memory from being written (write protection), while the other prevents code memory from being read (read protection).

The BWRP, SWRP and GWRP bits control write protection; and BSS<2:0>, SSS<2:0> and GSS<1:0> bits control read protection. The Chip Erase `ERASEB` command sets all the code protection bits to '1', which allows the device to be programmed.

When write protection is enabled, any programming operation to code memory will fail. When read protection is enabled, any read from code memory will cause a '0x0' to be read, regardless of the actual contents of code memory. Since the programming executive always verifies what it programs, attempting to program code memory with read protection enabled will also result in failure.

It is imperative that all code protection bits are '1' while the device is being programmed and verified. Only after the device is programmed and verified should any of the above bits be programmed to '0' (see [Section 5.7 "Configuration Bits Programming"](#)).

In addition to code memory protection, parts of data EEPROM and/or data RAM can be configured to be accessible only by code resident in the Boot Segment and/or Secure Segment. The sizes of these "reserved" sections are user-configurable, using the EBS, RBS<1:0>, ESS<1:0> and RSS<1:0> bits.

**Note 1:** All bits in the FBS, FSS and FGS Configuration registers can only be programmed to a value of '0'. `ERASEB` is the only way to reprogram code-protect bits from ON ('0') to OFF ('1').

**2:** If any of the code-protect bits in FBS, FSS, or FGS are clear, the entire device must be erased before it can be reprogrammed.

# dsPIC30F Flash Programming Specification

## 5.8 Exiting Enhanced ICSP Mode

The Enhanced ICSP mode is exited by removing power from the device or bringing MCLR to VIL. When normal user mode is next entered, the program that was stored using Enhanced ICSP will execute.

FIGURE 5-5: CONFIGURATION BIT PROGRAMMING FLOW



# dsPIC30F Flash Programming Specification

## 6.0 OTHER PROGRAMMING FEATURES

### 6.1 Erasing Memory

Memory is erased by using an `ERASEB`, `ERASED` or `ERASEP` command, as detailed in [Section 8.5 “Command Descriptions”](#). Code memory can be erased by row using `ERASEP`. Data EEPROM can be erased by row using `ERASED`. When memory is erased, the affected memory locations are set to ‘1’s.

`ERASEB` provides several Bulk Erase options. Performing a Chip Erase with the `ERASEB` command clears all code memory, data EEPROM and code protection registers. Alternatively, `ERASEB` can be used to selectively erase either all code memory or data EEPROM. Erase options are summarized in [Table 6-1](#).

**TABLE 6-1: ERASE OPTIONS**

Command	Affected Region
<code>ERASEB</code>	Entire chip <sup>(1)</sup> or all code memory or all data EEPROM, or erase by segment
<code>ERASED</code>	Specified rows of data EEPROM
<code>ERASEP</code> <sup>(2)</sup>	Specified rows of code memory

- Note 1:** The system operation Configuration registers and device ID registers are not erasable.
- 2:** `ERASEP` cannot be used to erase code-protect Configuration bits. These bits must be erased using `ERASEB`.

### 6.2 Modifying Memory

Instead of bulk-erasing the device before programming, it is possible that you may want to modify only a section of an already programmed device. In this situation, Chip Erase is not a realistic option.

Instead, you can erase selective rows of code memory and data EEPROM using `ERASEP` and `ERASED`, respectively. You can then reprogram the modified rows with the `PROGP` and `PROGD` command pairs. In these cases, when code memory is programmed, single-panel programming must be specified in the `PROGP` command.

For modification of Advanced Code Protection bits for a particular segment, the entire chip must first be erased with the `ERASEB` command. Alternatively, on devices that support Advanced Security, individual segments (code and/or data EEPROM) may be erased, by suitably changing the MS (Memory Select)

field in the `ERASEB` command. The code-protect Configuration bits can then be reprogrammed using the `PROGC` command.

**Note:** If read or write code protection is enabled for a segment, no modifications can be made to that segment until code protection is disabled. Code protection can only be disabled by performing a Chip Erase or by performing a Segment Erase operation for the required segment.

### 6.3 Reading Memory

The `READD` command reads the data EEPROM, Configuration bits and device ID of the device. This command only returns 16-bit data and operates on 16-bit registers. `READD` can be used to return the entire contents of data EEPROM.

The `READP` command reads the code memory of the device. This command only returns 24-bit data packed as described in [Section 8.3 “Packed Data Format”](#). `READP` can be used to read up to 32K instruction words of code memory.

**Note:** Reading an unimplemented memory location causes the programming executive to reset. All `READD` and `READP` commands **must** specify only valid memory locations.

### 6.4 Programming Executive Software Version

At times, it may be necessary to determine the version of programming executive stored in executive memory. The `QVER` command performs this function. See [Section 8.5.11 “QVER Command”](#) for more details about this command.

### 6.5 Data EEPROM Information in the Hexadecimal File

To allow portability of code, the programmer must read the data EEPROM information from the hexadecimal file. If data EEPROM information is not present, a simple warning message should be issued by the programmer. Similarly, when saving a hexadecimal file, all data EEPROM information must be included. An option to not include the data EEPROM information can be provided.

Microchip Technology Inc. believes that this feature is important for the benefit of the end customer.

# dsPIC30F Flash Programming Specification

## 6.6 Configuration Information in the Hexadecimal File

To allow portability of code, the programmer must read the Configuration register locations from the hexadecimal file. If configuration information is not present in the hexadecimal file, a simple warning message should be issued by the programmer. Similarly, while saving a hexadecimal file, all configuration information must be included. An option to not include the configuration information can be provided.

Microchip Technology Inc. feels strongly that this feature is important for the benefit of the end customer.

## 6.7 Unit ID

The dsPIC30F devices contain 32 instructions of Unit ID. These are located at addresses 0x8005C0 through 0x8005FF. The Unit ID can be used for storing product information such as serial numbers, system manufacturing dates, manufacturing lot numbers and other such application-specific information.

A Bulk Erase does not erase the Unit ID locations. Instead, erase all executive memory using steps 1-4 as shown in [Table 12-1](#), and program the Unit ID along with the programming executive. Alternately, use a Row Erase to erase the row containing the Unit ID locations.

## 6.8 Checksum Computation

Checksums for the dsPIC30F are 16 bits in size. The checksum is to total sum of the following:

- Contents of code memory locations
- Contents of Configuration registers

[Table A-1](#) describes how to calculate the checksum for each device. All memory locations are summed one byte at a time, using only their native data size. More specifically, Configuration and device ID registers are summed by adding the lower two bytes of these locations (the upper byte is ignored), while code memory is summed by adding all three bytes of code memory.

**Note:** The checksum calculation differs depending on the code-protect setting. [Table A-1](#) describes how to compute the checksum for an unprotected device and a read-protected device. Regardless of the code-protect setting, the Configuration registers can always be read.

## 7.0 PROGRAMMER – PROGRAMMING EXECUTIVE COMMUNICATION

### 7.1 Communication Overview

The programmer and programming executive have a master-slave relationship, where the programmer is the master programming device and the programming executive is the slave.

All communication is initiated by the programmer in the form of a command. Only one command at a time can be sent to the programming executive. In turn, the programming executive only sends one response to the programmer after receiving and processing a command. The programming executive command set is described in [Section 8.0 “Programming Executive Commands”](#). The response set is described in [Section 9.0 “Programming Executive Responses”](#).

### 7.2 Communication Interface and Protocol

The Enhanced ICSP interface is a 2-wire SPI interface implemented using the PGC and PGD pins. The PGC pin is used as a clock input pin, and the clock source must be provided by the programmer. The PGD pin is used for sending command data to, and receiving response data from, the programming executive. All serial data is transmitted on the falling edge of PGC and latched on the rising edge of PGD. All data transmissions are sent Most Significant bit (MSb) first, using 16-bit mode (see [Figure 7-1](#)).

**FIGURE 7-1: PROGRAMMING EXECUTIVE SERIAL TIMING**



Since a 2-wire SPI interface is used, and data transmissions are bidirectional, a simple protocol is used to control the direction of PGD. When the programmer completes a command transmission, it releases the PGD line and allows the programming executive to drive this line high. The programming executive keeps the PGD line high to indicate that it is processing the command.

After the programming executive has processed the command, it brings PGD low for 15  $\mu$ sec to indicate to the programmer that the response is available to be

# dsPIC30F Flash Programming Specification

clocked out. The programmer can begin to clock out the response 20  $\mu$ sec after PGD is brought low, and it must provide the necessary amount of clock pulses to receive the entire response from the programming executive.

Once the entire response is clocked out, the programmer should terminate the clock on PGC until it is time to send another command to the programming executive. This protocol is illustrated in Figure 7-2.

## 7.3 SPI Rate

In Enhanced ICSP mode, the dsPIC30F operates from the fast internal RC oscillator, which has a nominal frequency of 7.37 MHz. This oscillator frequency yields an effective system clock frequency of 1.84 MHz. Since the SPI module operates in Slave mode, the programmer must limit the SPI clock rate to a frequency no greater than 1 MHz.

**Note:** If the programmer provides the SPI with a clock faster than 1 MHz, the behavior of the programming executive will be unpredictable.

## 7.4 Time Outs

The programming executive uses no Watchdog Timer or time out for transmitting responses to the programmer. If the programmer does not follow the flow control mechanism using PGC, as described in Section 7.2 “Communication Interface and Protocol”, it is possible that the programming executive will behave unexpectedly while trying to send a response to the programmer. Since the programming executive has no time out, it is imperative that the programmer correctly follow the described communication protocol.

As a safety measure, the programmer should use the command time outs identified in Table 8-1. If the command time out expires, the programmer should reset the programming executive and start programming the device again.

**FIGURE 7-2: PROGRAMMING EXECUTIVE – PROGRAMMER COMMUNICATION PROTOCOL**



# dsPIC30F Flash Programming Specification

## 8.0 PROGRAMMING EXECUTIVE COMMANDS

### 8.1 Command Set

The programming executive command set is shown in [Table 8-1](#). This table contains the opcode, mnemonic, length, time out and description for each command. Functional details on each command are provided in the command descriptions (see [Section 8.5 “Command Descriptions”](#)).

### 8.2 Command Format

All programming executive commands have a general format consisting of a 16-bit header and any required data for the command (see [Figure 8-1](#)). The 16-bit header consists of a 4-bit opcode field, which is used to identify the command, followed by a 12-bit command length field.

**FIGURE 8-1: COMMAND FORMAT**

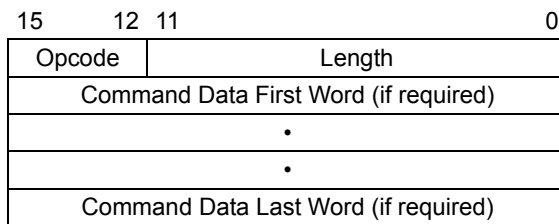

The command opcode must match one of those in the command set. Any command that is received which does not match the list in [Table 8-1](#) will return a “NACK” response (see [Section 9.2.1 “Opcode Field”](#)).

The command length is represented in 16-bit words since the SPI operates in 16-bit mode. The programming executive uses the Command Length field to determine the number of words to read from the SPI port. If the value of this field is incorrect, the command will not be properly received by the programming executive.

### 8.3 Packed Data Format

When 24-bit instruction words are transferred across the 16-bit SPI interface, they are packed to conserve space using the format shown in [Figure 8-2](#). This format minimizes traffic over the SPI and provides the programming executive with data that is properly aligned for performing table write operations.

**FIGURE 8-2: PACKED INSTRUCTION WORD FORMAT**

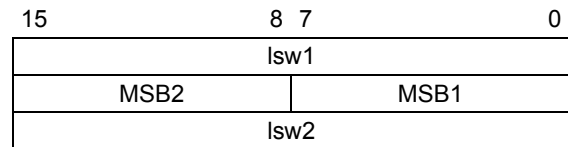

lswx: Least significant 16 bits of instruction word  
MSBx: Most Significant Byte of instruction word

**Note:** When the number of instruction words transferred is odd, MSB2 is zero and lsw2 cannot be transmitted.

### 8.4 Programming Executive Error Handling

The programming executive will “NACK” all unsupported commands. Additionally, due to the memory constraints of the programming executive, no checking is performed on the data contained in the Programmer command. It is the responsibility of the programmer to command the programming executive with valid command arguments, or the programming operation may fail. Additional information on error handling is provided in [Section 9.2.3 “QE\\_Code Field”](#).

# dsPIC30F Flash Programming Specification

**TABLE 8-1: PROGRAMMING EXECUTIVE COMMAND SET**

Opcode	Mnemonic	Length (16-bit words)	Time Out	Description
0x0	SCHECK	1	1 ms	Sanity check.
0x1	READD	4	1 ms/row	Read N 16-bit words of data EEPROM, Configuration registers or device ID starting from specified address.
0x2	READP	4	1 ms/row	Read N 24-bit instruction words of code memory starting from specified address.
0x3	Reserved	N/A	N/A	This command is reserved. It will return a NACK.
0x4	PROGD <sup>(2)</sup>	19	5 ms	Program one row of data EEPROM at the specified address, then verify.
0x5	PROGP <sup>(1)</sup>	51	5 ms	Program one row of code memory at the specified address, then verify.
0x6	PROGC	4	5 ms	Write byte or 16-bit word to specified Configuration register.
0x7	ERASEB	2	5 ms	Bulk Erase (entire code memory or data EEPROM), or erase by segment.
0x8	ERASED <sup>(2)</sup>	3	5 ms/row	Erase rows of data EEPROM from specified address.
0x9	ERASEP <sup>(1)</sup>	3	5 ms/row	Erase rows of code memory from specified address.
0xA	QBLANK	3	300 ms	Query if the code memory and data EEPROM are blank.
0xB	QVER	1	1 ms	Query the programming executive software version.

- Note 1:** One row of code memory consists of (32) 24-bit words. Refer to [Table 5-2](#) for device-specific information.  
**Note 2:** One row of data EEPROM consists of (16) 16-bit words. Refer to [Table 5-3](#) for device-specific information.

# dsPIC30F Flash Programming Specification

## 8.5 Command Descriptions

All commands that are supported by the programming executive are described in [Section 8.5.1 “SCHECK Command”](#) through [Section 8.5.11 “QVER Command”](#).

### 8.5.1 SCHECK COMMAND



Field	Description
Opcode	0x0
Length	0x1

The `SCHECK` command instructs the programming executive to do nothing, but generate a response. This command is used as a “sanity check” to verify that the programming executive is operational.

**Expected Response (2 words):**

0x1000  
0x0002

**Note:** This instruction is not required for programming, but is provided for development purposes only.

### 8.5.2 READD COMMAND



Field	Description
Opcode	0x1
Length	0x4
Reserved0	0x0
N	Number of 16-bit words to read (max of 2048)
Reserved1	0x0
Addr_MSB	MSB of 24-bit source address
Addr_LS	LS 16 bits of 24-bit source address

The `READD` command instructs the programming executive to read N 16-bit words of memory starting from the 24-bit address specified by `Addr_MSB` and `Addr_LS`. This command can only be used to read 16-bit data. It can be used to read data EEPROM, Configuration registers and the device ID.

**Expected Response (2+N words):**

0x1100  
N + 2  
Data word 1  
...  
Data word N

**Note:** Reading unimplemented memory will cause the programming executive to reset.

# dsPIC30F Flash Programming Specification

## 8.5.3 READP COMMAND

15	12	11	8	7	0
Opcode		Length			
N					
Reserved			Addr_MSB		
Addr_LS					

Field	Description
Opcode	0x2
Length	0x4
N	Number of 24-bit instructions to read (max of 32768)
Reserved	0x0
Addr_MSB	MSB of 24-bit source address
Addr_LS	LS 16 bits of 24-bit source address

The READP command instructs the programming executive to read N 24-bit words of code memory starting from the 24-bit address specified by Addr\_MSB and Addr\_LS. This command can only be used to read 24-bit data. All data returned in response to this command uses the packed data format described in [Section 8.3 “Packed Data Format”](#).

### Expected Response (2 + 3 \* N/2 words for N even):

0x1200  
 2 + 3 \* N/2  
 Least significant program memory word 1  
 ...  
 Least significant data word N

### Expected Response (4 + 3 \* (N - 1)/2 words for N odd):

0x1200  
 4 + 3 \* (N - 1)/2  
 Least significant program memory word 1  
 ...  
 MSB of program memory word N (zero padded)

**Note:** Reading unimplemented memory will cause the programming executive to reset.

## 8.5.4 PROGD COMMAND

15	12	11	8	7	0
Opcode		Length			
Reserved			Addr_MSB		
Addr_LS					
D_1					
D_2					
...					
D_16					

Field	Description
Opcode	0x4
Length	0x13
Reserved	0x0
Addr_MSB	MSB of 24-bit destination address
Addr_LS	LS 16 bits of 24-bit destination address
D_1	16-bit data word 1
D_2	16-bit data word 2
...	16-bit data words 3 through 15
D_16	16-bit data word 16

The PROGD command instructs the programming executive to program one row of data EEPROM. The data to be programmed is specified by the 16 data words (D\_1, D\_2, ..., D\_16) and is programmed to the destination address specified by Addr\_MSB and Addr\_LSB. The destination address should be a multiple of 0x20.

Once the row of data EEPROM has been programmed, the programming executive verifies the programmed data against the data in the command.

### Expected Response (2 words):

0x1400  
 0x0002

**Note:** Refer to [Table 5-3](#) for data EEPROM size information.

# dsPIC30F Flash Programming Specification

## 8.5.5 PROGP COMMAND

15	12	11	8	7	0
Opcode		Length			
Reserved		Addr_MSB			
Addr_LS					
D_1					
D_2					
...					
D_N					

Field	Description
Opcode	0x5
Length	0x33
Reserved	0x0
Addr_MSB	MSB of 24-bit destination address
Addr_LS	LS 16 bits of 24-bit destination address
D_1	16-bit data word 1
D_2	16-bit data word 2
...	16-bit data word 3 through 47
D_48	16-bit data word 48

The `PROGP` command instructs the programming executive to program one row of code memory (32 instruction words) to the specified memory address. Programming begins with the row address specified in the command. The destination address should be a multiple of 0x40.

The data to program to memory, located in command words D\_1 through D\_48, must be arranged using the packed instruction word format shown in [Figure 8-2](#).

After all data has been programmed to code memory, the programming executive verifies the programmed data against the data in the command.

### Expected Response (2 words):

0x1500  
0x0002

**Note:** Refer to [Table 5-2](#) for code memory size information.

## 8.5.6 PROGC COMMAND

15	12	11	8	7	0
Opcode		Length			
Reserved		Addr_MSB			
Addr_LS					
Data					

Field	Description
Opcode	0x6
Length	0x4
Reserved	0x0
Addr_MSB	MSB of 24-bit destination address
Addr_LS	LS 16 bits of 24-bit destination address
Data	Data to program

The `PROGC` command programs data to the specified Configuration register and verifies the programming. Configuration registers are 16 bits wide, and this command allows one Configuration register to be programmed.

### Expected Response (2 words):

0x1600  
0x0002

**Note:** This command can only be used for programming Configuration registers.

# dsPIC30F Flash Programming Specification

## 8.5.7 ERASEB COMMAND

15 12 11 2 0

Opcode	Length
Reserved	
MS	

Field	Description
Opcode	0x7
Length	0x2
Reserved	0x0
MS	Select memory to erase: 0x0 = All Code in General Segment 0x1 = All Data EEPROM in General Segment 0x2 = All Code and Data EEPROM in General Segment, interrupt vectors and FGS Configuration register 0x3 = Full Chip Erase 0x4 = All Code and Data EEPROM in Boot, Secure and General Segments, and FBS, FSS and FGS Configuration registers 0x5 = All Code and Data EEPROM in Secure and General Segments, and FSS and FGS Configuration registers 0x6 = All Data EEPROM in Boot Segment 0x7 = All Data EEPROM in Secure Segment

The **ERASEB** command performs a Bulk Erase. The MS field selects the memory to be bulk erased, with options for erasing Code and/or Data EEPROM in individual memory segments.

When Full Chip Erase is selected, the following memory regions are erased:

- All code memory (even if code-protected)
- All data EEPROM
- All code-protect Configuration registers

Only the executive code memory, Unit ID, device ID and Configuration registers that are not code-protected remain intact after a Chip Erase.

### Expected Response (2 words):

0x1700  
0x0002

**Note:** A Full Chip Erase cannot be performed in low-voltage programming systems (VDD less than 4.5 volts). **ERASED** and **ERASEP** must be used to erase code memory, executive memory and data memory. Alternatively, individual Segment Erase operations may be performed.

## 8.5.8 ERASED COMMAND

15 12 11 8 7 0

Opcode	Length
Num_Rows	Addr_MSB
Addr_LS	

Field	Description
Opcode	0x8
Length	0x3
Num_Rows	Number of rows to erase (max of 128)
Addr_MSB	MSB of 24-bit base address
Addr_LS	LS 16 bits of 24-bit base address

The **ERASED** command erases the specified number of rows of data EEPROM from the specified base address. The specified base address must be a multiple of 0x20. Since the data EEPROM is mapped to program space, a 24-bit base address must be specified.

After the erase is performed, all targeted bytes of data EEPROM will contain 0xFF.

### Expected Response (2 words):

0x1800  
0x0002

**Note:** The **ERASED** command cannot be used to erase the Configuration registers or device ID. Code-protect Configuration registers can only be erased with the **ERASEB** command, while the device ID is read-only.

# dsPIC30F Flash Programming Specification

## 8.5.9 ERASEP COMMAND

15	12	11	8	7	0
Opcode		Length			
Num_Rows			Addr_MSB		
Addr_LS					

Field	Description
Opcode	0x9
Length	0x3
Num_Rows	Number of rows to erase
Addr_MSB	MSB of 24-bit base address
Addr_LS	LS 16 bits of 24-bit base address

The `ERASEP` command erases the specified number of rows of code memory from the specified base address. The specified base address must be a multiple of 0x40.

Once the erase is performed, all targeted words of code memory contain 0xFFFFFFFF.

### Expected Response (2 words):

0x1900  
0x0002

**Note:** The `ERASEP` command cannot be used to erase the Configuration registers or device ID. Code-protect Configuration registers can only be erased with the `ERASEB` command, while the device ID is read-only.

## 8.5.10 QBLANK COMMAND

15	12	11	0
Opcode		Length	
PSize			
Reserved		DSize	

Field	Description
Opcode	0xA
Length	0x3
PSize	Length of program memory to check (in 24-bit words), max of 49152
Reserved	0x0
DSize	Length of data memory to check (in 16-bit words), max of 2048

The `QBLANK` command queries the programming executive to determine if the contents of code memory and data EEPROM are blank (contains all '1's). The size of code memory and data EEPROM to check must be specified in the command.

The Blank Check for code memory begins at 0x0 and advances toward larger addresses for the specified number of instruction words. The Blank Check for data EEPROM begins at 0x7FFFFE and advances toward smaller addresses for the specified number of data words.

`QBLANK` returns a `QE_Code` of 0xF0 if the specified code memory and data EEPROM are blank. Otherwise, `QBLANK` returns a `QE_Code` of 0x0F.

### Expected Response (2 words for blank device):

0x1AF0  
0x0002

### Expected Response (2 words for non-blank device):

0x1A0F  
0x0002

**Note:** The `QBLANK` command does not check the system Configuration registers. The `READD` command must be used to determine the state of the Configuration registers.

# dsPIC30F Flash Programming Specification

## 8.5.11 QVER COMMAND

15	12	11	0
Opcode		Length	

Field	Description
Opcode	0xB
Length	0x1

The QVER command queries the version of the programming executive software stored in test memory. The “version.revision” information is returned in the response’s QE\_Code using a single byte with the following format: main version in upper nibble and revision in the lower nibble (i.e., 0x23 is version 2.3 of programming executive software).

### Expected Response (2 words):

0x1BMN (where “MN” stands for version M.N)  
0x0002

## 9.0 PROGRAMMING EXECUTIVE RESPONSES

### 9.1 Overview

The programming executive sends a response to the programmer for each command that it receives. The response indicates if the command was processed correctly, and includes any required response or error data.

The programming executive response set is shown in Table 9-1. This table contains the opcode, mnemonic and description for each response. The response format is described in Section 9.2 “Response Format”.

**TABLE 9-1: PROGRAMMING EXECUTIVE RESPONSE SET**

Opcode	Mnemonic	Description
0x1	PASS	Command successfully processed.
0x2	FAIL	Command unsuccessfully processed.
0x3	NACK	Command not known.

## 9.2 Response Format

As shown in Example 9-1, all programming executive responses have a general format consisting of a two word header and any required data for the command. Table 9-2 lists the fields and their descriptions.

**EXAMPLE 9-1: FORMAT**

15	12	11	8	7	0
Opcode		Last_Cmd		QE_Code	
Length					
D_1 (if applicable)					
...					
D_N (if applicable)					

**TABLE 9-2: FIELDS AND DESCRIPTIONS**

Field	Description
Opcode	Response opcode.
Last_Cmd	Programmer command that generated the response.
QE_Code	Query code or Error code.
Length	Response length in 16-bit words (includes 2 header words.)
D_1	First 16-bit data word (if applicable).
D_N	Last 16-bit data word (if applicable).

### 9.2.1 Opcode FIELD

The Opcode is a 4-bit field in the first word of the response. The Opcode indicates how the command was processed (see Table 9-1). If the command is processed successfully, the response opcode is PASS. If there is an error in processing the command, the response opcode is FAIL, and the QE\_Code indicates the reason for the failure. If the command sent to the programming executive is not identified, the programming executive returns a NACK response.

### 9.2.2 Last\_Cmd FIELD

The Last\_Cmd is a 4-bit field in the first word of the response and indicates the command that the programming executive processed. Since the programming executive can only process one command at a time, this field is technically not required. However, it can be used to verify whether the programming executive correctly received the command that the programmer transmitted.

# dsPIC30F Flash Programming Specification

## 9.2.3 QE\_Code FIELD

The QE\_Code is a byte in the first word of the response. This byte is used to return data for query commands, and error codes for all other commands.

When the programming executive processes one of the two query commands (QBLANK or QVER), the returned opcode is always PASS and the QE\_Code holds the query response data. The format of the QE\_Code for both queries is shown in [Table 9-3](#).

**TABLE 9-3: QE\_Code FOR QUERIES**

Query	QE_Code
QBLANK	0x0F = Code memory and data EEPROM are NOT blank 0xF0 = Code memory and data EEPROM are blank
QVER	0xMN, where programming executive software version = M.N (i.e., 0x32 means software version 3.2)

When the programming executive processes any command other than a Query, the QE\_Code represents an error code. Supported error codes are shown in [Table 9-4](#). If a command is successfully processed, the returned QE\_Code is set to 0x0, which indicates that there was no error in the command processing. If the verify of the programming for the PROG, PROGPG or PROGCG command fails, the QE\_Code is set to 0x1. For all other programming executive errors, the QE\_Code is 0x2.

**TABLE 9-4: QE\_Code FOR NON-QUERY COMMANDS**

QE_Code	Description
0x0	No error
0x1	Verify failed
0x2	Other error

## 9.2.4 RESPONSE LENGTH

The response length indicates the length of the programming executive's response in 16-bit words. This field includes the 2 words of the response header.

With the exception of the response for the READD and READP commands, the length of each response is only 2 words.

The response to the READD command is  $N + 2$  words, where N is the number of words specified in the READD command.

The response to the READP command uses the packed instruction word format described in [Section 8.3 "Packed Data Format"](#). When reading an odd number of program memory words (N odd), the response to the READP command is  $(3 \cdot (N + 1)/2 + 2)$  words. When reading an even number of program memory words (N even), the response to the READP command is  $(3 \cdot N/2 + 2)$  words.

# dsPIC30F Flash Programming Specification

## 10.0 DEVICE ID

The device ID region is 2 x 16 bits and can be read using the `READD` command. This region of memory is read-only and can also be read when code protection is enabled.

Table 10-1 shows the device ID for each device, Table 10-2 shows the device ID registers and Table 10-3 describes the bit field of each register.

**TABLE 10-1: DEVICE IDS**

Device	DEVID	Silicon Revision							
		A0	A1	A2	A3	A4	B0	B1	B2
dsPIC30F2010	0x0040	0x1000	0x1001	0x1002	0x1003	0x1004	—	—	—
dsPIC30F2011	0x0240	—	0x1001	—	—	—	—	—	—
dsPIC30F2012	0x0241	—	0x1001	—	—	—	—	—	—
dsPIC30F3010	0x01C0	0x1000	0x1001	0x1002	—	—	—	—	—
dsPIC30F3011	0x01C1	0x1000	0x1001	0x1002	—	—	—	—	—
dsPIC30F3012	0x00C1	—	—	—	—	—	0x1040	0x1041	—
dsPIC30F3013	0x00C3	—	—	—	—	—	0x1040	0x1041	—
dsPIC30F3014	0x0160	—	0x1001	0x1002	—	—	—	—	—
dsPIC30F4011	0x0101	—	0x1001	0x1002	0x1003	0x1003	—	—	—
dsPIC30F4012	0x0100	—	0x1001	0x1002	0x1003	0x1003	—	—	—
dsPIC30F4013	0x0141	—	0x1001	0x1002	—	—	—	—	—
dsPIC30F5011	0x0080	—	0x1001	0x1002	0x1003	0x1003	—	—	—
dsPIC30F5013	0x0081	—	0x1001	0x1002	0x1003	0x1003	—	—	—
dsPIC30F5015	0x0200	0x1000	—	—	—	—	—	—	—
dsPIC30F5016	0x0201	0x1000	—	—	—	—	—	—	—
dsPIC30F6010	0x0188	—	—	—	—	—	—	0x1040	0x1042
dsPIC30F6010A	0x0281	—	—	0x1002	0x1003	0x1004	—	—	—
dsPIC30F6011	0x0192	—	—	—	0x1003	—	—	0x1040	0x1042
dsPIC30F6011A	0x02C0	—	—	0x1002	—	—	0x1040	0x1041	—
dsPIC30F6012	0x0193	—	—	—	0x1003	—	—	0x1040	0x1042
dsPIC30F6012A	0x02C2	—	—	0x1002	—	—	0x1040	0x1041	—
dsPIC30F6013	0x0197	—	—	—	0x1003	—	—	0x1040	0x1042
dsPIC30F6013A	0x02C1	—	—	0x1002	—	—	0x1040	0x1041	—
dsPIC30F6014	0x0198	—	—	—	0x1003	—	—	0x1040	0x1042
dsPIC30F6014A	0x02C3	—	—	0x1002	—	—	0x1040	0x1041	—
dsPIC30F6015	0x0280	—	—	0x1002	0x1003	0x1004	—	—	—

**TABLE 10-2: dsPIC30F DEVICE ID REGISTERS**

Address	Name	Bit													
		15	14	13	12	11	10	9	8	7	6	5	4	3	2
0xFF0000	DEVID	DEVID<15:0>													
0xFF0002	DEVREV	PROC<3:0>			REV<5:0>					DOT<5:0>					

# dsPIC30F Flash Programming Specification

**TABLE 10-3: DEVICE ID BITS DESCRIPTION**

Bit Field	Register	Description
DEVID<15:0>	DEVID	Encodes the device ID.
PROC<3:0>	DEVREV	Encodes the process of the device (always read as 0x001).
REV<5:0>	DEVREV	Encodes the major revision number of the device. 000000 = A 000001 = B 000010 = C
DOT<5:0>	DEVREV	Encodes the minor revision number of the device. 000000 = 0 000001 = 1 000010 = 2 000011 = 3

Examples:

Rev A.1 = 0000 0000 0000 0001  
Rev A.2 = 0000 0000 0000 0010  
Rev B.0 = 0000 0000 0100 0000

This formula applies to all dsPIC30F devices, with the exception of the following:

- dsPIC30F6010
- dsPIC30F6011
- dsPIC30F6012
- dsPIC30F6013
- dsPIC30F6014

Refer to [Table 10-1](#) for the actual revision IDs.

# dsPIC30F Flash Programming Specification

## 11.0 ICSP™ MODE

### 11.1 ICSP Mode

ICSP mode is a special programming protocol that allows you to read and write to the dsPIC30F programming executive. The ICSP mode is the second (and slower) method used to program the device. This mode also has the ability to read the contents of executive memory to determine whether the programming executive is present. This capability is accomplished by applying control codes and instructions serially to the device using pins PGC and PGD.

In ICSP mode, the system clock is taken from the PGC pin, regardless of the device's oscillator Configuration bits. All instructions are first shifted serially into an internal buffer, then loaded into the Instruction register and executed. No program fetching occurs from internal memory. Instructions are fed in 24 bits at a time. PGD is used to shift data in and PGC is used as both the serial shift clock and the CPU execution clock.

Data is transmitted on the rising edge and latched on the falling edge of PGC. For all data transmissions, the Least Significant bit (LSb) is transmitted first.

**Note 1:** During ICSP operation, the operating frequency of PGC must not exceed 5 MHz.

**2:** Because ICSP is slower, it is recommended that only Enhanced ICSP (E-ICSP) mode be used for device programming, as described in [Section 5.1 “Overview of the Programming Process”](#).

### 11.2 ICSP Operation

Upon entry into ICSP mode, the CPU is idle. Execution of the CPU is governed by an internal state machine. A 4-bit control code is clocked in using PGC and PGD, and this control code is used to command the CPU (see [Table 11-1](#)).

The SIX control code is used to send instructions to the CPU for execution, while the REGOUT control code is used to read data out of the device via the VISI register. The operation details of ICSP mode are provided in [Section 11.2.1 “SIX Serial Instruction Execution”](#) and [Section 11.2.2 “REGOUT Serial Instruction Execution”](#).

TABLE 11-1: CPU CONTROL CODES IN ICSP™ MODE

4-bit Control Code	Mnemonic	Description
0000b	SIX	Shift in 24-bit instruction and execute.
0001b	REGOUT	Shift out the VISI register.
0010b-1111b	N/A	Reserved.

#### 11.2.1 SIX SERIAL INSTRUCTION EXECUTION

The SIX control code allows execution of dsPIC30F assembly instructions. When the SIX code is received, the CPU is suspended for 24 clock cycles as the instruction is then clocked into the internal buffer. Once the instruction is shifted in, the state machine allows it to be executed over the next four clock cycles. While the received instruction is executed, the state machine simultaneously shifts in the next 4-bit command (see [Figure 11-2](#)).

**Note 1:** Coming out of the ICSP entry sequence, the first 4-bit control code is always forced to SIX and a forced NOP instruction is executed by the CPU. Five additional PGC clocks are needed on start-up, thereby resulting in a 9-bit SIX command instead of the normal 4-bit SIX command. After the forced SIX is clocked in, ICSP operation resumes as normal (the next 24 clock cycles load the first instruction word to the CPU). See [Figure 11-1](#) for details.

**2:** TBLRDH, TBLRDL, TBLWTH and TBLWTL instructions must be followed by a NOP instruction.

# dsPIC30F Flash Programming Specification

## 11.2.2 REGOUT SERIAL INSTRUCTION EXECUTION

The REGOUT control code allows for data to be extracted from the device in ICSP mode. It is used to clock the contents of the VISI register out of the device over the PGD pin. Once the REGOUT control code is received, eight clock cycles are required to process the command. During this time, the CPU is held idle. After these eight cycles, an additional 16 cycles are required to clock the data out (see Figure 11-3).

The REGOUT instruction is unique because the PGD pin is an input when the control code is transmitted to the device. However, once the control code is processed, the PGD pin becomes an output as the VISI register is shifted out. After the contents of the VISI are shifted out, PGD becomes an input again as the state machine holds the CPU idle until the next 4-bit control code is shifted in.

**Note:** Once the contents of VISI are shifted out, the dsPIC® DSC device maintains PGD as an output until the first rising edge of the next clock is received.

**FIGURE 11-1: PROGRAM ENTRY AFTER RESET**



**FIGURE 11-2: SIX SERIAL EXECUTION**



**FIGURE 11-3: REGOUT SERIAL EXECUTION**

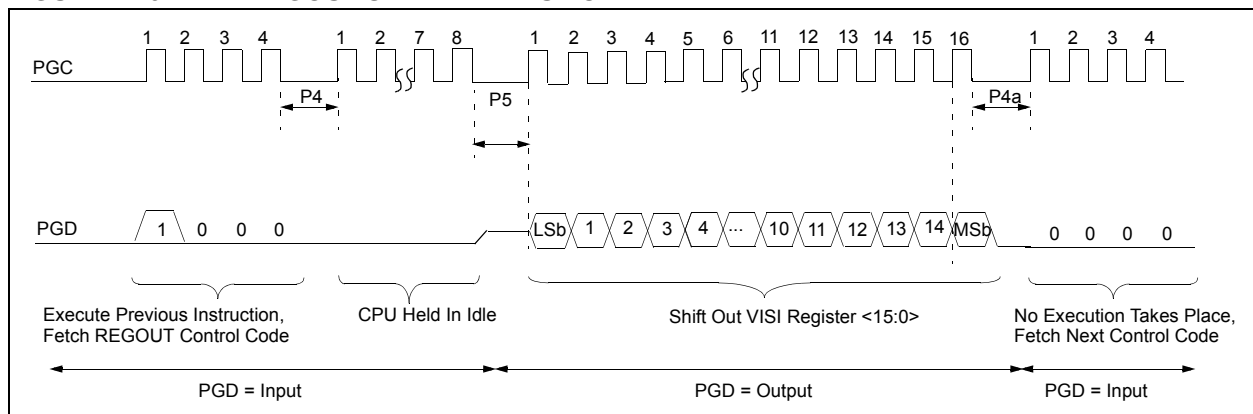

# dsPIC30F Flash Programming Specification

## 11.3 Entering ICSP Mode

The ICSP mode is entered by holding PGC and PGD low, raising MCLR/VPP to VIH (high voltage), and then performing additional steps as illustrated in Figure 11-4.

- Note 1:** The sequence that places the device into ICSP mode places all unused I/O pins to the high-impedance state.
- 2:** Once ICSP mode is entered, the PC is set to 0x0 (the Reset vector).
- 3:** Before leaving the Reset vector, execute two GOTO instructions, followed by a single NOP instruction must be executed.

**FIGURE 11-4: ENTERING ICSP™ MODE**

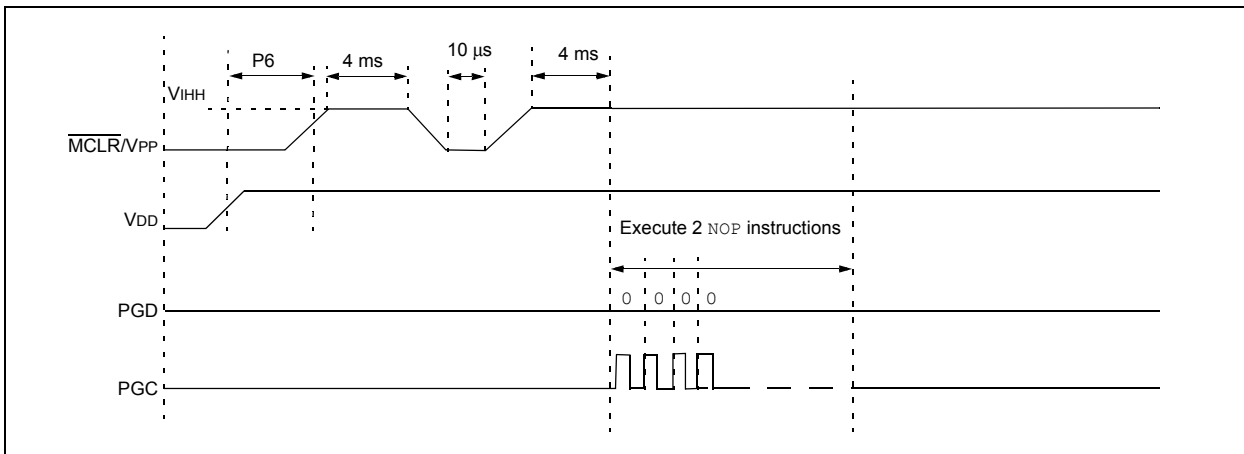

# dsPIC30F Flash Programming Specification

## 11.4 Flash Memory Programming in ICSP Mode

Programming in ICSP mode is described in [Section 11.4.1 “Programming Operations”](#) through [Section 11.4.3 “Starting and Stopping a Programming Cycle”](#). Step-by-step procedures are described in [Section 11.5 “Erasing Program Memory in Normal-Voltage Systems”](#) through [Section 11.13 “Reading the Application ID Word”](#). All programming operations must use serial execution, as described in [Section 11.2 “ICSP Operation”](#).

### 11.4.1 PROGRAMMING OPERATIONS

Flash memory write and erase operations are controlled by the NVMCON register. Programming is performed by setting NVMCON to select the type of erase operation ([Table 11-2](#)) or write operation ([Table 11-3](#)), writing a key sequence to enable the programming and initiating the programming by setting the WR control bit, NVMCON<15>.

In ICSP mode, all programming operations are externally timed. An external 2 ms delay must be used between setting the WR control bit and clearing the WR control bit to complete the programming operation.

**TABLE 11-2: NVMCON ERASE OPERATIONS**

NVMCON Value	Erase Operation
0x407F	Erase all code memory, data memory (does not erase UNIT ID).
0x4075	Erase 1 row (16 words) of data EEPROM.
0x4074	Erase 1 word of data EEPROM.
0x4072	Erase all executive memory.
0x4071	Erase 1 row (32 instruction words) from 1 panel of code memory.
0x406E	Erase Boot Secure and General Segments, then erase FBS, FSS and FGS configuration registers.
0x4066	Erase all Data EEPROM allocated to Boot Segment.
0x405E	Erase Secure and General Segments, then erase FSS and FGS configuration registers.
0x4056	Erase all Data EEPROM allocated to Secure Segment.
0x404E	Erase General Segment, then erase FGS configuration register.
0x4046	Erase all Data EEPROM allocated to General Segment.

**TABLE 11-3: NVMCON WRITE OPERATIONS**

NVMCON Value	Write Operation
0x4008	Write 1 word to configuration memory.
0x4005	Write 1 row (16 words) to data memory.
0x4004	Write 1 word to data memory.
0x4001	Write 1 row (32 instruction words) into 1 panel of program memory.

### 11.4.2 UNLOCKING NVMCON FOR PROGRAMMING

Writes to the WR bit (NVMCON<15>) are locked to prevent accidental programming from taking place. Writing a key sequence to the NVMKEY register unlocks the WR bit and allows it to be written to. The unlock sequence is performed as follows:

```
MOV    #0x55, W8
MOV    W8, NVMKEY
MOV    #0xAA, W9
MOV    W9, NVMKEY
```

**Note:** Any working register, or working register pair, can be used to write the unlock sequence.

### 11.4.3 STARTING AND STOPPING A PROGRAMMING CYCLE

Once the unlock key sequence has been written to the NVMKEY register, the WR bit (NVMCON<15>) is used to start and stop an erase or write cycle. Setting the WR bit initiates the programming cycle. Clearing the WR bit terminates the programming cycle.

All erase and write cycles must be externally timed. An external delay must be used between setting and clearing the WR bit. Starting and stopping a programming cycle is performed as follows:

```
BSET   NVMCON, #WR
<Wait 2 ms>
BCLR   NVMCON, #WR
```

## 11.5 Erasing Program Memory in Normal-Voltage Systems

The procedure for erasing program memory (all code memory, data memory, executive memory and code-protect bits) consists of setting NVMCON to 0x407F, unlocking NVMCON for erasing and then executing the programming cycle. This method of bulk erasing program memory only works for systems where VDD is between 4.5 volts and 5.5 volts. The method for erasing program memory for systems with a lower VDD (3.0 volts–4.5 volts) is described in [Section 6.1 “Erasing Memory”](#).

# dsPIC30F Flash Programming Specification

Table 11-4 shows the ICSP programming process for bulk-erasing program memory. This process includes the ICSP command code, which must be transmitted (for each instruction) to the Least Significant bit first using the PGC and PGD pins (see Figure 11-2).

If an individual Segment Erase operation is required, the NVMCON value must be replaced by the value for the corresponding Segment Erase operation.

**Note:** Program memory must be erased before writing any data to program memory.

**TABLE 11-4: SERIAL INSTRUCTION EXECUTION FOR BULK ERASING PROGRAM MEMORY (ONLY IN NORMAL-VOLTAGE SYSTEMS)**

Command (Binary)	Data (Hexadecimal)	Description
<b>Step 1: Exit the Reset vector.</b>		
0000	040100	GOTO 0x100
0000	040100	GOTO 0x100
0000	000000	NOP
<b>Step 2: Set NVMCON to program the FBS Configuration register.<sup>(1)</sup></b>		
0000	24008A	MOV #0x4008, W10
0000	883B0A	MOV W10, NVMCON
<b>Step 3: Initialize the TBLPAG and write pointer (W7) for TBLWT instruction for Configuration register.<sup>(1)</sup></b>		
0000	200F80	MOV #0xF8, W0
0000	880190	MOV W0, TBLPAG
0000	200067	MOV #0x6, W7
<b>Step 4: Load the Configuration Register data to W6.<sup>(1)</sup></b>		
0000	EB0300	CLR W6
0000	000000	NOP
<b>Step 5: Load the Configuration Register write latch. Advance W7 to point to next Configuration register.<sup>(1)</sup></b>		
0000	BB1B86	TBLWTL W6, [W7++]
<b>Step 6: Unlock the NVMCON for programming the Configuration register.<sup>(1)</sup></b>		
0000	200558	MOV #0x55, W8
0000	200AA9	MOV #0xAA, W9
0000	883B38	MOV W8, NVMKEY
0000	883B39	MOV W9, NVMKEY
<b>Step 7: Initiate the programming cycle.<sup>(1)</sup></b>		
0000	A8E761	BSET NVMCON, #WR
0000	000000	NOP
0000	000000	NOP
—	—	Externally time 2 ms
0000	000000	NOP
0000	000000	NOP
0000	A9E761	BCLR NVMCON, #WR
0000	000000	NOP
0000	000000	NOP
<b>Step 8: Repeat steps 5-7 one time to program 0x0000 to RESERVED2 Configuration register.<sup>(1)</sup></b>		
<b>Step 9: Set the NVMCON to erase all Program Memory.</b>		
00000	2407FA	MOV #0x407F, W10
0000	883B0A	MOV W10, NVMCON
<b>Step 10: Unlock the NVMCON for programming.</b>		

**Note 1:** Steps 2-8 are only required for the dsPIC30F5011/5013 devices. These steps may be skipped for all other devices in the dsPIC30F family.

# dsPIC30F Flash Programming Specification

**TABLE 11-4: SERIAL INSTRUCTION EXECUTION FOR BULK ERASING PROGRAM MEMORY (ONLY IN NORMAL-VOLTAGE SYSTEMS) (CONTINUED)**

Command (Binary)	Data (Hexadecimal)	Description
0000	200558	MOV #0x55, W8
0000	883B38	MOV W8, NVMKEY
0000	200AA9	MOV #0xAA, W9
0000	883B39	MOV W9, NVMKEY
<b>Step 11: Initiate the erase cycle.</b>		
0000	A8E761	BSET NVMCON, #WR
0000	000000	NOP
0000	000000	NOP
—	—	Externally time 'P13a' ms (see <a href="#">Section 13.0 “AC/DC Characteristics and Timing Requirements”</a> )
0000	000000	NOP
0000	000000	NOP
0000	A9E761	BCLR NVMCON, #WR
0000	000000	NOP
0000	000000	NOP

**Note 1:** Steps 2-8 are only required for the dsPIC30F5011/5013 devices. These steps may be skipped for all other devices in the dsPIC30F family.

# dsPIC30F Flash Programming Specification

## 11.6 Erasing Program Memory in Low-Voltage Systems

The procedure for erasing program memory (all code memory and data memory) in low-voltage systems (with VDD between 2.5 volts and 4.5 volts) is quite different than the procedure for erasing program memory in normal-voltage systems. Instead of using a Bulk Erase operation, each region of memory must be individually erased by row. Namely, all of the code memory, executive memory and data memory must be erased one row at a time. This procedure is detailed in [Table 11-5](#).

Due to security restrictions, the FBS, FSS and FGS register cannot be erased in low-voltage systems. Once any bits in the FGS register are programmed to '0', they can only be set back to '1' by performing a Bulk Erase in a normal-voltage system. Alternatively, a Segment Erase operation can be performed instead of a Bulk Erase.

Normal-voltage systems can also be used to erase program memory as shown in [Table 11-5](#). However, since this method is more time-consuming and does not clear the code-protect bits, it is not recommended.

**Note:** Program memory must be erased before writing any data to program memory.

**TABLE 11-5: SERIAL INSTRUCTION EXECUTION FOR ERASING PROGRAM MEMORY (EITHER IN LOW-VOLTAGE OR NORMAL-VOLTAGE SYSTEMS)**

Command (Binary)	Data (Hexadecimal)	Description
<b>Step 1: Exit the Reset vector.</b>		
0000	040100	GOTO 0x100
0000	040100	GOTO 0x100
0000	000000	NOP
<b>Step 2: Initialize NVMADR and NVMADRU to erase code memory and initialize W7 for row address updates.</b>		
0000	EB0300	CLR W6
0000	883B16	MOV W6, NVMADR
0000	883B26	MOV W6, NVMADRU
0000	200407	MOV #0x40, W7
<b>Step 3: Set NVMCON to erase 1 row of code memory.</b>		
0000	24071A	MOV #0x4071, W10
0000	883B0A	MOV W10, NVMCON
<b>Step 4: Unlock the NVMCON to erase 1 row of code memory.</b>		
0000	200558	MOV #0x55, W8
0000	883B38	MOV W8, NVMKEY
0000	200AA9	MOV #0xAA, W9
0000	883B39	MOV W9, NVMKEY
<b>Step 5: Initiate the erase cycle.</b>		
0000	A8E761	BSET NVMCON, #WR
0000	000000	NOP
0000	000000	NOP
—	—	Externally time 'P13a' ms (see <a href="#">Section 13.0 "AC/DC Characteristics and Timing Requirements"</a> )
0000	000000	NOP
0000	000000	NOP
0000	A9E761	BCLR NVMCON, #WR
0000	000000	NOP
0000	000000	NOP

# dsPIC30F Flash Programming Specification

**TABLE 11-5: SERIAL INSTRUCTION EXECUTION FOR ERASING PROGRAM MEMORY (EITHER IN LOW-VOLTAGE OR NORMAL-VOLTAGE SYSTEMS) (CONTINUED)**

Command (Binary)	Data (Hexadecimal)	Description
<b>Step 6:</b> Update the row address stored in NVMADRU:NVMADR. When W6 rolls over to 0x0, NVMADRU must be incremented.		
0000	430307	ADD W6, W7, W6
0000	AF0042	BTSC SR, #C
0000	EC2764	INC NVMADRU
0000	883B16	MOV W6, NVMADR
<b>Step 7:</b> Reset device internal PC.		
0000	040100	GOTO 0x100
0000	000000	NOP
<b>Step 8:</b> Repeat Steps 3-7 until all rows of code memory are erased.		
<b>Step 9:</b> Initialize NVMADR and NVMADRU to erase executive memory and initialize W7 for row address updates.		
0000	EB0300	CLR W6
0000	883B16	MOV W6, NVMADR
0000	200807	MOV #0x80, W7
0000	883B27	MOV W7, NVMADRU
0000	200407	MOV #0x40, W7
<b>Step 10:</b> Set NVMCON to erase 1 row of executive memory.		
0000	24071A	MOV #0x4071, W10
0000	883B0A	MOV W10, NVMCON
<b>Step 11:</b> Unlock the NVMCON to erase 1 row of executive memory.		
0000	200558	MOV #0x55, W8
0000	883B38	MOV W8, NVMKEY
0000	200AA9	MOV #0xAA, W9
0000	883B39	MOV W9, NVMKEY
<b>Step 12:</b> Initiate the erase cycle.		
0000	A8E761	BSET NVMCON, #WR
0000	000000	NOP
0000	000000	NOP
—	—	Externally time 'P13a' ms (see <a href="#">Section 13.0 "AC/DC Characteristics and Timing Requirements"</a> )
0000	000000	NOP
0000	000000	NOP
0000	A9E761	BCLR NVMCON, #WR
0000	000000	NOP
0000	000000	NOP
<b>Step 13:</b> Update the row address stored in NVMADR.		
0000	430307	ADD W6, W7, W6
0000	883B16	MOV W6, NVMADR
<b>Step 14:</b> Reset device internal PC.		
0000	040100	GOTO 0x100
0000	000000	NOP
<b>Step 15:</b> Repeat Steps 10-14 until all 24 rows of executive memory are erased.		
<b>Step 16:</b> Initialize NVMADR and NVMADRU to erase data memory and initialize W7 for row address updates.		
0000	2XXXX6	MOV #<lower 16-bits of starting Data EEPROM address>, W6
0000	883B16	MOV W6, NVMADR
0000	2007F6	MOV #0x7F, W6
0000	883B16	MOV W6, NVMADRU
0000	200207	MOV #0x20, W7
<b>Step 17:</b> Set NVMCON to erase 1 row of data memory.		
0000	24075A	MOV #0x4075, W10
0000	883B0A	MOV W10, NVMCON

# dsPIC30F Flash Programming Specification

**TABLE 11-5: SERIAL INSTRUCTION EXECUTION FOR ERASING PROGRAM MEMORY (EITHER IN LOW-VOLTAGE OR NORMAL-VOLTAGE SYSTEMS) (CONTINUED)**

Command (Binary)	Data (Hexadecimal)	Description
<b>Step 18: Unlock the NVMCON to erase 1 row of data memory.</b>		
0000	200558	MOV #0x55, W8
0000	883B38	MOV W8, NVMKEY
0000	200AA9	MOV #0xAA, W9
0000	883B39	MOV W9, NVMKEY
<b>Step 19: Initiate the erase cycle.</b>		
0000	A8E761	BSET NVMCON, #WR
0000	000000	NOP
0000	000000	NOP
—	—	Externally time 'P13a' ms (see <a href="#">Section 13.0 “AC/DC Characteristics and Timing Requirements”</a> )
0000	000000	NOP
0000	000000	NOP
0000	A9E761	BCLR NVMCON, #WR
0000	000000	NOP
0000	000000	NOP
<b>Step 20: Update the row address stored in NVMADR.</b>		
0000	430307	ADD W6, W7, W6
0000	883B16	MOV W6, NVMADR
<b>Step 21: Reset device internal PC.</b>		
0000	040100	GOTO 0x100
0000	000000	NOP
<b>Step 22: Repeat Steps 17-21 until all rows of data memory are erased.</b>		

# dsPIC30F Flash Programming Specification

## 11.7 Writing Configuration Memory

The FOSC, FWDT, FBORPOR and FICD registers are not erasable. It is recommended that all Configuration registers be set to a default value after erasing program memory. The FWDT, FBORPOR and FICD registers can be set to a default all '1's value by programming 0xFFFF to each register. Since these registers contain unimplemented bits that read as '0' the default values shown in [Table 11-6](#) will be read instead of 0xFFFF. The recommended default FOSC value is 0xC100, which selects the FRC clock oscillator setting.

The FGS, FBS and FSS Configuration registers are special since they enable code protection for the device. For security purposes, once any bit in these registers is programmed to '0' (to enable some code protection feature), it can only be set back to '1' by performing a Bulk Erase or Segment Erase as described in [Section 11.5 "Erasing Program Memory in Normal-Voltage Systems"](#). Programming these bits from a '0' to '1' is not possible, but they may be programmed from a '1' to a '0' to enable code protection.

[Table 11-7](#) shows the ICSP programming details for clearing the Configuration registers. In Step 1, the Reset vector is exited. In Step 2, the write pointer (W7) is loaded with 0x0000, which is the original destination address (in TBLPAG 0xF8 of program memory). In Step 3, the NVMCON is set to program one Configura-

tion register. In Step 4, the TBLPAG register is initialized, to 0xF8, for writing to the Configuration registers. In Step 5, the value to write to the each Configuration register (0xFFFF) is loaded to W6. In Step 6, the Configuration register data is written to the write latch using the TBLWTL instruction. In Steps 7 and 8, the NVMCON is unlocked for programming and the programming cycle is initiated, as described in [Section 11.4 "Flash Memory Programming in ICSP Mode"](#). In Step 9, the internal PC is set to 0x100 as a safety measure to prevent the PC from incrementing into unimplemented memory. Lastly, Steps 3-9 are repeated six times until all seven Configuration registers are cleared.

**TABLE 11-6: DEFAULT CONFIGURATION REGISTER VALUES**

Address	Register	Default Value
0xF80000	FOSC	0xC100
0xF80002	FWDT	0x803F
0xF80004	FBORPOR	0x87B3
0xF80006	FBS	0x310F
0xF80008	FSS	0x330F
0xF8000A	FGS	0x0007
0xF8000C	FICD	0xC003

**TABLE 11-7: SERIAL INSTRUCTION EXECUTION FOR WRITING CONFIGURATION REGISTERS**

Command (Binary)	Data (Hexadecimal)	Description
<b>Step 1: Exit the Reset vector.</b>		
0000	040100	GOTO 0x100
0000	040100	GOTO 0x100
0000	000000	NOP
<b>Step 2: Initialize the write pointer (W7) for the TBLWT instruction.</b>		
0000	200007	MOV #0x0000, W7
<b>Step 3: Set the NVMCON to program 1 Configuration register.</b>		
0000	24008A	MOV #0x4008, W10
0000	883B0A	MOV W10, NVMCON
<b>Step 4: Initialize the TBLPAG register.</b>		
0000	200F80	MOV #0xF8, W0
0000	880190	MOV W0, TBLPAG
<b>Step 5: Load the Configuration register data to W6.</b>		
0000	2xxxx0	MOV #<CONFIG_VALUE>, W0
0000	000000	NOP

# dsPIC30F Flash Programming Specification

**TABLE 11-7: SERIAL INSTRUCTION EXECUTION FOR WRITING CONFIGURATION REGISTERS (CONTINUED)**

Command (Binary)	Data (Hexadecimal)	Description
<b>Step 6: Write the Configuration register data to the write latch and increment the write pointer.</b>		
0000	BB1B96	TBLWTL W6, [W7++]
0000	000000	NOP
0000	000000	NOP
<b>Step 7: Unlock the NVMCON for programming.</b>		
0000	200558	MOV #0x55, W8
0000	883B38	MOV W8, NVMKEY
0000	200AA9	MOV #0xAA, W9
0000	883B39	MOV W9, NVMKEY
<b>Step 8: Initiate the write cycle.</b>		
0000	A8E761	BSET NVMCON, #WR
0000	000000	NOP
0000	000000	NOP
–	–	Externally time 'P12a' ms (see <a href="#">Section 13.0 “AC/DC Characteristics and Timing Requirements”</a> )
0000	000000	NOP
0000	000000	NOP
0000	A9E761	BCLR NVMCON, #WR
0000	000000	NOP
0000	000000	NOP
<b>Step 9: Reset device internal PC.</b>		
0000	040100	GOTO 0x100
0000	000000	NOP
<b>Step 10: Repeat steps 3-9 until all 7 Configuration registers are cleared.</b>		

# dsPIC30F Flash Programming Specification

## 11.8 Writing Code Memory

The procedure for writing code memory is similar to the procedure for clearing the Configuration registers, except that 32 instruction words are programmed at a time. To facilitate this operation, working registers W0:W5 are used as temporary holding registers for the data to be programmed.

Table 11-8 shows the ICSP programming details, including the serial pattern with the ICSP command code, which must be transmitted Least Significant bit first using the PGC and PGD pins (see Figure 11-2). In Step 1, the Reset vector is exited. In Step 2, the NVMCON register is initialized for single-panel programming of code memory. In Step 3, the 24-bit starting destination address for programming is loaded into the TBLPAG register and W7 register. The upper byte of the starting destination address is stored to TBLPAG, while the lower 16 bits of the destination address are stored to W7.

To minimize the programming time, the same packed instruction format that the programming executive uses is utilized (Figure 8-2). In Step 4, four packed instruction words are stored to working registers W0:W5 using the MOV instruction and the read pointer W6 is initialized. The contents of W0:W5 holding the packed instruction word data is shown in Figure 11-4.

In Step 5, eight TBLWT instructions are used to copy the data from W0:W5 to the write latches of code memory. Since code memory is programmed 32 instruction words at a time, Steps 4 and 5 are repeated eight times to load all the write latches (Step 6).

After the write latches are loaded, programming is initiated by writing to the NVMKEY and NVMCON registers in Steps 7 and 8. In Step 9, the internal PC is reset to 0x100. This is a precautionary measure to prevent the PC from incrementing into unimplemented memory when large devices are being programmed. Lastly, in Step 10, Steps 2-9 are repeated until all of code memory is programmed.

**FIGURE 11-5: PACKED INSTRUCTION WORDS IN W0:W5**

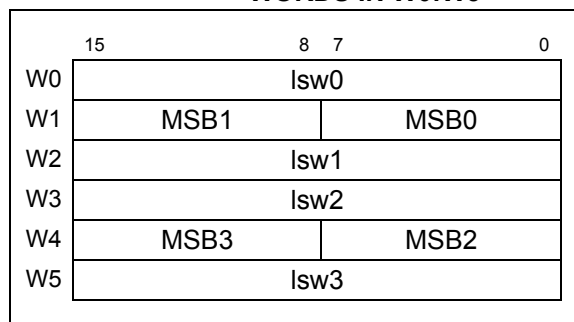

**TABLE 11-8: SERIAL INSTRUCTION EXECUTION FOR WRITING CODE MEMORY**

Command (Binary)	Data (Hexadecimal)	Description
<b>Step 1: Exit the Reset vector.</b>		
0000	040100	GOTO 0x100
0000	040100	GOTO 0x100
0000	000000	NOF
<b>Step 2: Set the NVMCON to program 32 instruction words.</b>		
0000	24001A	MOV #0x4001, W10
0000	883B0A	MOV W10, NVMCON
<b>Step 3: Initialize the write pointer (W7) for TBLWT instruction.</b>		
0000	200xx0	MOV #<DestinationAddress23:16>, W0
0000	880190	MOV W0, TBLPAG
0000	2xxxx7	MOV #<DestinationAddress15:0>, W7
<b>Step 4: Initialize the read pointer (W6) and load W0:W5 with the next 4 instruction words to program.</b>		
0000	2xxxx0	MOV #<LSW0>, W0
0000	2xxxx1	MOV #<MSB1:MSB0>, W1
0000	2xxxx2	MOV #<LSW1>, W2
0000	2xxxx3	MOV #<LSW2>, W3
0000	2xxxx4	MOV #<MSB3:MSB2>, W4
0000	2xxxx5	MOV #<LSW3>, W5

# dsPIC30F Flash Programming Specification

**TABLE 11-8: SERIAL INSTRUCTION EXECUTION FOR WRITING CODE MEMORY (CONTINUED)**

Command (Binary)	Data (Hexadecimal)	Description
<b>Step 5: Set the read pointer (W6) and load the (next set of) write latches.</b>		
0000	EB0300	CLR W6
0000	000000	NOP
0000	BB0BB6	TBLWTL [W6++], [W7]
0000	000000	NOP
0000	000000	NOP
0000	BBDBB6	TBLWTH.B [W6++], [W7++]
0000	000000	NOP
0000	000000	NOP
0000	BBEBB6	TBLWTH.B [W6++], [++W7]
0000	000000	NOP
0000	000000	NOP
0000	BB1BB6	TBLWTL [W6++], [W7++]
0000	000000	NOP
0000	000000	NOP
0000	BB0BB6	TBLWTL [W6++], [W7]
0000	000000	NOP
0000	000000	NOP
0000	BBDBB6	TBLWTH.B [W6++], [W7++]
0000	000000	NOP
0000	000000	NOP
0000	BBEBB6	TBLWTH.B [W6++], [++W7]
0000	000000	NOP
0000	000000	NOP
0000	BB1BB6	TBLWTL [W6++], [W7++]
0000	000000	NOP
0000	000000	NOP
<b>Step 6: Repeat steps 4-5 eight times to load the write latches for 32 instructions.</b>		
<b>Step 7: Unlock the NVMCON for writing.</b>		
0000	200558	MOV #0x55, W8
0000	883B38	MOV W8, NVMKEY
0000	200AA9	MOV #0xAA, W9
0000	883B39	MOV W9, NVMKEY
<b>Step 8: Initiate the write cycle.</b>		
0000	A8E761	BSET NVMCON, #WR
0000	000000	NOP
0000	000000	NOP
—	—	Externally time 'P12a' ms (see <a href="#">Section 13.0 “AC/DC Characteristics and Timing Requirements”</a> )
0000	000000	NOP
0000	000000	NOP
0000	A9E761	BCLR NVMCON, #WR
0000	000000	NOP
0000	000000	NOP
<b>Step 9: Reset device internal PC.</b>		
0000	040100	GOTO 0x100
0000	000000	NOP
<b>Step 10: Repeat steps 2-9 until all code memory is programmed.</b>		

# dsPIC30F Flash Programming Specification

## 11.9 Writing Data EEPROM

The procedure for writing data EEPROM is very similar to the procedure for writing code memory, except that fewer words are programmed in each operation. When writing data EEPROM, one row of data EEPROM is programmed at a time. Each row consists of sixteen 16-bit data words. Since fewer words are programmed

during each operation, only working registers W0:W3 are used as temporary holding registers for the data to be programmed.

Table 11-9 shows the ICSP programming details for writing data EEPROM. Note that a different NVMCON value is required to write to data EEPROM, and that the TBLPAG register is hard-coded to 0x7F (the upper byte address of all locations of data EEPROM).

**TABLE 11-9: SERIAL INSTRUCTION EXECUTION FOR WRITING DATA EEPROM**

Command (Binary)	Data (Hexadecimal)	Description
<b>Step 1: Exit the Reset vector.</b>		
0000	040100	GOTO 0x100
0000	040100	GOTO 0x100
0000	000000	NOP
<b>Step 2: Set the NVMCON to write 16 data words.</b>		
0000	24005A	MOV #0x4005, W10
0000	883B0A	MOV W10, NVMCON
<b>Step 3: Initialize the write pointer (W7) for TBLWT instruction.</b>		
0000	2007F0	MOV #0x7F, W0
0000	880190	MOV W0, TBLPAG
0000	2xxxx7	MOV #<DestinationAddress15:0>, W7
<b>Step 4: Load W0:W3 with the next 4 data words to program.</b>		
0000	2xxxx0	MOV #<WORD0>, W0
0000	2xxxx1	MOV #<WORD1>, W1
0000	2xxxx2	MOV #<WORD2>, W2
0000	2xxxx3	MOV #<WORD3>, W3
<b>Step 5: Set the read pointer (W6) and load the (next set of) write latches.</b>		
0000	EB0300	CLR W6
0000	000000	NOP
0000	BB1BB6	TBLWTL [W6++], [W7++]
0000	000000	NOP
0000	000000	NOP
0000	BB1BB6	TBLWTL [W6++], [W7++]
0000	000000	NOP
0000	000000	NOP
0000	BB1BB6	TBLWTL [W6++], [W7++]
0000	000000	NOP
0000	000000	NOP
0000	BB1BB6	TBLWTL [W6++], [W7++]
0000	000000	NOP
0000	000000	NOP
<b>Step 6: Repeat steps 4-5 four times to load the write latches for 16 data words.</b>		

# dsPIC30F Flash Programming Specification

**TABLE 11-9: SERIAL INSTRUCTION EXECUTION FOR WRITING DATA EEPROM (CONTINUED)**

Command (Binary)	Data (Hexadecimal)	Description
<b>Step 7: Unlock the NVMCON for writing.</b>		
0000	200558	MOV #0x55, W8
0000	883B38	MOV W8, NVMKEY
0000	200AA9	MOV #0xAA, W9
0000	883B39	MOV W9, NVMKEY
<b>Step 8: Initiate the write cycle.</b>		
0000	A8E761	BSET NVMCON, #WR
0000	000000	NOP
0000	000000	NOP
—	—	Externally time 'P12a' ms (see <a href="#">Section 13.0 “AC/DC Characteristics and Timing Requirements”</a> )
0000	000000	NOP
0000	000000	NOP
0000	A9E761	BCLR NVMCON, #WR
0000	000000	NOP
0000	000000	NOP
<b>Step 9: Reset device internal PC.</b>		
0000	040100	GOTO 0x100
0000	000000	NOP
<b>Step 10: Repeat steps 2-9 until all data memory is programmed.</b>		

# dsPIC30F Flash Programming Specification

## 11.10 Reading Code Memory

Reading from code memory is performed by executing a series of TBLRD instructions and clocking out the data using the REGOUT command. To ensure efficient execution and facilitate verification on the programmer, four instruction words are read from the device at a time.

Table 11-10 shows the ICSP programming details for reading code memory. In Step 1, the Reset vector is exited. In Step 2, the 24-bit starting source address for reading is loaded into the TBLPAG and W6 registers. The upper byte of the starting source address is stored to TBLPAG, while the lower 16 bits of the source address are stored to W6.

To minimize the reading time, the packed instruction word format that was utilized for writing is also used for reading (see Figure 11-5). In Step 3, the write pointer W7 is initialized, and four instruction words are read from code memory and stored to working registers W0:W5. In Step 4, the four instruction words are clocked out of the device from the VISI register using the REGOUT command. In Step 5, the internal PC is reset to 0x100, as a precautionary measure, to prevent the PC from incrementing into unimplemented memory when large devices are being read. Lastly, in Step 6, Steps 3-5 are repeated until the desired amount of code memory is read.

**TABLE 11-10: SERIAL INSTRUCTION EXECUTION FOR READING CODE MEMORY**

Command (Binary)	Data (Hexadecimal)	Description
<b>Step 1: Exit the Reset vector.</b>		
0000	040100	GOTO 0x100
0000	040100	GOTO 0x100
0000	000000	NOP
<b>Step 2: Initialize TBLPAG and the read pointer (W6) for TBLRD instruction.</b>		
0000	200xx0	MOV #<SourceAddress23:16>, W0
0000	880190	MOV W0, TBLPAG
0000	2xxxx6	MOV #<SourceAddress15:0>, W6
<b>Step 3: Initialize the write pointer (W7) and store the next four locations of code memory to W0:W5.</b>		
0000	EB0380	CLR W7
0000	000000	NOP
0000	BA1B96	TBLRDL [W6], [W7++]
0000	000000	NOP
0000	000000	NOP
0000	BADBB6	TBLRDH.B [W6++], [W7++]
0000	000000	NOP
0000	000000	NOP
0000	BADBD6	TBLRDH.B [++W6], [W7++]
0000	000000	NOP
0000	000000	NOP
0000	BA1BB6	TBLRDL [W6++], [W7++]
0000	000000	NOP
0000	000000	NOP
0000	BA1B96	TBLRDL [W6], [W7++]
0000	000000	NOP
0000	000000	NOP
0000	BADBB6	TBLRDH.B [W6++], [W7++]
0000	000000	NOP
0000	000000	NOP
0000	BADBD6	TBLRDH.B [++W6], [W7++]
0000	000000	NOP
0000	000000	NOP
0000	BA0BB6	TBLRDL [W6++], [W7]
0000	000000	NOP
0000	000000	NOP

# dsPIC30F Flash Programming Specification

**TABLE 11-10: SERIAL INSTRUCTION EXECUTION FOR READING CODE MEMORY (CONTINUED)**

Command (Binary)	Data (Hexadecimal)	Description
<b>Step 4: Output W0:W5 using the VISI register and REGOUT command.</b>		
0000	883C20	MOV W0, VISI
0000	000000	NOP
0001	<VISI>	Clock out contents of VISI register
0000	000000	NOP
0000	883C21	MOV W1, VISI
0000	000000	NOP
0001	<VISI>	Clock out contents of VISI register
0000	000000	NOP
0000	883C22	MOV W2, VISI
0000	000000	NOP
0001	<VISI>	Clock out contents of VISI register
0000	000000	NOP
0000	883C23	MOV W3, VISI
0000	000000	NOP
0001	<VISI>	Clock out contents of VISI register
0000	000000	NOP
0000	883C24	MOV W4, VISI
0000	000000	NOP
0001	<VISI>	Clock out contents of VISI register
0000	000000	NOP
0000	883C25	MOV W5, VISI
0000	000000	NOP
0001	<VISI>	Clock out contents of VISI register
0000	000000	NOP
<b>Step 5: Reset the device internal PC.</b>		
0000	040100	GOTO 0x100
0000	000000	NOP
<b>Step 6: Repeat steps 3-5 until all desired code memory is read.</b>		

# dsPIC30F Flash Programming Specification

## 11.11 Reading Configuration Memory

The procedure for reading configuration memory is similar to the procedure for reading code memory, except that 16-bit data words are read instead of 24-bit words. Since there are seven Configuration registers, they are read one register at a time.

Table 11-11 shows the ICSP programming details for reading all of the configuration memory. Note that the TBLPAG register is hard-coded to 0xF8 (the upper byte address of configuration memory), and the read pointer W6 is initialized to 0x0000.

**TABLE 11-11: SERIAL INSTRUCTION EXECUTION FOR READING ALL CONFIGURATION MEMORY**

Command (Binary)	Data (Hexadecimal)	Description
<b>Step 1: Exit the Reset vector.</b>		
0000	040100	GOTO 0x100
0000	040100	GOTO 0x100
0000	000000	NOP
<b>Step 2: Initialize TBLPAG, and the read pointer (W6) and the write pointer (W7) for TBLRD instruction.</b>		
0000	200F80	MOV #0xF8, W0
0000	880190	MOV W0, TBLPAG
0000	EB0300	CLR W6
0000	EB0380	CLR W7
0000	000000	NOP
<b>Step 3: Read the Configuration register and write it to the VISI register (located at 0x784).</b>		
0000	BA0BB6	TBLRDL [W6++], [W7]
0000	000000	NOP
0000	000000	NOP
0000	883C20	MOV W0, VISI
0000	000000	NOP
<b>Step 4: Output the VISI register using the REGOUT command.</b>		
0001	<VISI>	Clock out contents of VISI register
0000	000000	NOP
<b>Step 5: Reset device internal PC.</b>		
0000	040100	GOTO 0x100
0000	000000	NOP
<b>Step 6: Repeat steps 3-5 six times to read all of configuration memory.</b>		

# dsPIC30F Flash Programming Specification

## 11.12 Reading Data Memory

The procedure for reading data memory is similar to that of reading code memory, except that 16-bit data words are read instead of 24-bit words. Since less data is read in each operation, only working registers W0:W3 are used as temporary holding registers for the data to be read.

Table 11-12 shows the ICSP programming details for reading data memory. Note that the TBLPAG register is hard-coded to 0x7F (the upper byte address of all locations of data memory).

**TABLE 11-12: SERIAL INSTRUCTION EXECUTION FOR READING DATA MEMORY**

Command (Binary)	Data (Hexadecimal)	Description
<b>Step 1: Exit the Reset vector.</b>		
0000	040100	GOTO 0x100
0000	040100	GOTO 0x100
0000	000000	NOP
<b>Step 2: Initialize TBLPAG and the read pointer (W6) for TBLRD instruction.</b>		
0000	2007F0	MOV #0x7F, W0
0000	880190	MOV W0, TBLPAG
0000	2xxxx6	MOV #<SourceAddress15:0>, W6
<b>Step 3: Initialize the write pointer (W7) and store the next four locations of code memory to W0:W5.</b>		
0000	EB0380	CLR W7
0000	000000	NOP
0000	BA1BB6	TBLRD [W6++], [W7++]
0000	000000	NOP
0000	000000	NOP
0000	BA1BB6	TBLRD [W6++], [W7++]
0000	000000	NOP
0000	000000	NOP
0000	BA1BB6	TBLRD [W6++], [W7++]
0000	000000	NOP
0000	000000	NOP
0000	BA1BB6	TBLRD [W6++], [W7++]
0000	000000	NOP
0000	000000	NOP
<b>Step 4: Output W0:W5 using the VISI register and REGOUT command.</b>		
0000	883C20	MOV W0, VISI
0000	000000	NOP
0001	<VISI>	Clock out contents of VISI register
0000	000000	NOP
0000	883C21	MOV W1, VISI
0000	000000	NOP
0001	<VISI>	Clock out contents of VISI register
0000	000000	NOP
0000	883C22	MOV W2, VISI
0000	000000	NOP
0001	<VISI>	Clock out contents of VISI register
0000	000000	NOP
0000	883C23	MOV W3, VISI
0000	000000	NOP
0001	<VISI>	Clock out contents of VISI register
0000	000000	NOP
<b>Step 5: Reset device internal PC.</b>		
0000	040100	GOTO 0x100
0000	000000	NOP
<b>Step 6: Repeat steps 3-5 until all desired data memory is read.</b>		

# dsPIC30F Flash Programming Specification

## 11.13 Reading the Application ID Word

The application ID word is stored at address 0x8005BE in executive code memory. To read this memory location, you must use the SIX control code to move this program memory location to the VISI register. The REGOUT control code must then be used to clock the contents of the VISI register out of the device. The corresponding control and instruction codes that must be serially transmitted to the device to perform this operation are shown in [Table 11-13](#).

Once the programmer has clocked-out the application ID word, it must be inspected. If the application ID has the value 0xBB, the programming executive is resident in memory and the device can be programmed using the mechanism described in [Section 5.0 “Device Programming”](#). However, if the application ID has any other value, the programming executive is not resident in memory. It must be loaded to memory before the device can be programmed. The procedure for loading the programming executive to the memory is described in [Section 12.0 “Programming the Programming Executive to Memory”](#).

## 11.14 Exiting ICSP Mode

After confirming that the programming executive is resident in memory, or loading the programming executive, ICSP mode is exited by removing power to the device or bringing MCLR to VIL. Programming can then take place by following the procedure outlined in [Section 5.0 “Device Programming”](#).

**TABLE 11-13: SERIAL INSTRUCTION EXECUTION FOR READING THE APPLICATION ID WORD**

Command (Binary)	Data (Hexadecimal)	Description
<b>Step 1: Exit the Reset vector.</b>		
0000	040100	GOTO 0x100
0000	040100	GOTO 0x100
0000	000000	NOP
<b>Step 2: Initialize TBLPAG and the read pointer (W0) for TBLRD instruction.</b>		
0000	200800	MOV #0x80, W0
0000	880190	MOV W0, TBLPAG
0000	205BE0	MOV #0x5BE, W0
0000	207841	MOV VISI, W1
0000	000000	NOP
0000	BA0890	TBLRD [W0], [W1]
0000	000000	NOP
0000	000000	NOP
<b>Step 3: Output the VISI register using the REGOUT command.</b>		
0001	<VISI>	Clock out contents of the VISI register
0000	000000	NOP

# dsPIC30F Flash Programming Specification

## 12.0 PROGRAMMING THE PROGRAMMING EXECUTIVE TO MEMORY

Storing the programming executive to executive memory is similar to normal programming of code memory. The executive memory must first be erased, and then the programming executive must be programmed 32 words at a time. This control flow is summarized in [Table 12-1](#).

### 12.1 Overview

If it is determined that the programming executive does not reside in executive memory (as described in [Section 4.0 “Confirming the Contents of Executive Memory”](#)), it must be programmed into executive memory using ICSP and the techniques described in [Section 11.0 “ICSP™ Mode”](#).

**TABLE 12-1: PROGRAMMING THE PROGRAMMING EXECUTIVE**

Command (Binary)	Data (Hexadecimal)	Description
<b>Step 1: Exit the Reset vector and erase executive memory.</b>		
0000	040100	GOTO 0x100
0000	040100	GOTO 0x100
0000	000000	NOP
<b>Step 2: Initialize the NVMCON to erase executive memory.</b>		
0000	24072A	MOV #0x4072, W10
0000	883B0A	MOV W10, NVMCON
<b>Step 3: Unlock the NVMCON for programming.</b>		
0000	200558	MOV #0x55, W8
0000	883B38	MOV W8, NVMKEY
0000	200AA9	MOV #0xAA, W9
0000	883B39	MOV W9, NVMKEY
<b>Step 4: Initiate the erase cycle.</b>		
0000	A8E761	BSET NVMCON, #15
0000	000000	NOP
0000	000000	NOP
—	—	Externally time 'P13a' ms (see <a href="#">Section 13.0 “AC/DC Characteristics and Timing Requirements”</a> )
0000	000000	NOP
0000	000000	NOP
0000	A9E761	BCLR NVMCON, #15
0000	000000	NOP
0000	000000	NOP
<b>Step 5: Initialize the TBLPAG and the write pointer (W7).</b>		
0000	200800	MOV #0x80, W0
0000	880190	MOV W0, TBLPAG
0000	EB0380	CLR W7
0000	000000	NOP
0000	000000	NOP
<b>Step 6: Initialize the NVMCON to program 32 instruction words.</b>		
0000	24001A	MOV #0x4001, W10
0000	883B0A	MOV W10, NVMCON
<b>Step 7: Load W0:W5 with the next 4 words of packed programming executive code and initialize W6 for programming. Programming starts from the base of executive memory (0x800000) using W6 as a read pointer and W7 as a write pointer.</b>		
0000	2<LSW0>0	MOV #<LSW0>, W0
0000	2<MSB1:MSB0>1	MOV #<MSB1:MSB0>, W1
0000	2<LSW1>2	MOV #<LSW1>, W2
0000	2<LSW2>3	MOV #<LSW2>, W3
0000	2<MSB3:MSB2>4	MOV #<MSB3:MSB2>, W4
0000	2<LSW3>5	MOV #<LSW3>, W5

# dsPIC30F Flash Programming Specification

**TABLE 12-1: PROGRAMMING THE PROGRAMMING EXECUTIVE (CONTINUED)**

Command (Binary)	Data (Hexadecimal)	Description
<b>Step 8: Set the read pointer (W6) and load the (next four write) latches.</b>		
0000	EB0300	CLR W6
0000	000000	NOP
0000	BB0BB6	TBLWTL [W6++], [W7]
0000	000000	NOP
0000	000000	NOP
0000	BBDBB6	TBLWTH.B [W6++], [W7++]
0000	000000	NOP
0000	000000	NOP
0000	BEBBB6	TBLWTH.B [W6++], [++W7]
0000	000000	NOP
0000	000000	NOP
0000	BB1BB6	TBLWTL [W6++], [W7++]
0000	000000	NOP
0000	000000	NOP
0000	BB0BB6	TBLWTL [W6++], [W7]
0000	000000	NOP
0000	000000	NOP
0000	BBDBB6	TBLWTH.B [W6++], [W7++]
0000	000000	NOP
0000	000000	NOP
0000	BEBBB6	TBLWTH.B [W6++], [++W7]
0000	000000	NOP
0000	000000	NOP
0000	BB1BB6	TBLWTL [W6++], [W7++]
0000	000000	NOP
0000	000000	NOP
<b>Step 9: Repeat Steps 7-8 eight times to load the write latches for the 32 instructions.</b>		
<b>Step 10: Unlock the NVMCON for programming.</b>		
0000	200558	MOV #0x55, W8
0000	883B38	MOV W8, NVMKEY
0000	200AA9	MOV #0xAA, W9
0000	883B39	MOV W9, NVMKEY
<b>Step 11: Initiate the programming cycle.</b>		
0000	A8E761	BSET NVMCON, #15
0000	000000	NOP
0000	000000	NOP
—	—	Externally time 'P12a' ms (see <a href="#">Section 13.0 “AC/DC Characteristics and Timing Requirements”</a> )
0000	000000	NOP
0000	000000	NOP
0000	A9E761	BCLR NVMCON, #15
0000	000000	NOP
0000	000000	NOP
<b>Step 12: Reset the device internal PC.</b>		
0000	040100	GOTO 0x100
0000	000000	NOP
<b>Step 13: Repeat Steps 7-12 until all 23 rows of executive memory are programmed.</b>		

# dsPIC30F Flash Programming Specification

## 12.2 Programming Verification

After the programming executive has been programmed to executive memory using ICSP, it must be verified. Verification is performed by reading out the contents of executive memory and comparing it with the image of the programming executive stored in the programmer.

Reading the contents of executive memory can be performed using the same technique described in [Section 11.10 “Reading Code Memory”](#). A procedure for reading executive memory is shown in [Table 12-2](#). Note that in Step 2, the TBLPAG register is set to 0x80 such that executive memory may be read.

**TABLE 12-2: READING EXECUTIVE MEMORY**

Command (Binary)	Data (Hexadecimal)	Description
<b>Step 1: Exit the Reset vector.</b>		
0000	040100	GOTO 0x100
0000	040100	GOTO 0x100
0000	000000	NOP
<b>Step 2: Initialize TBLPAG and the read pointer (W6) for TBLRD instruction.</b>		
0000	200800	MOV #0x80, W0
0000	880190	MOV W0, TBLPAG
0000	EB0300	CLR W6
<b>Step 3: Initialize the write pointer (W7), and store the next four locations of executive memory to W0:W5.</b>		
0000	EB0380	CLR W7
0000	000000	NOP
0000	BA1B96	TBLRDL [W6], [W7++]
0000	000000	NOP
0000	000000	NOP
0000	BADBB6	TBLRDH.B [W6++], [W7++]
0000	000000	NOP
0000	000000	NOP
0000	BADBD6	TBLRDH.B [++W6], [W7++]
0000	000000	NOP
0000	000000	NOP
0000	BA1BB6	TBLRDL [W6++], [W7++]
0000	000000	NOP
0000	000000	NOP
0000	BA1B96	TBLRDL [W6], [W7++]
0000	000000	NOP
0000	000000	NOP
0000	BADBB6	TBLRDH.B [W6++], [W7++]
0000	000000	NOP
0000	000000	NOP
0000	BADBD6	TBLRDH.B [++W6], [W7++]
0000	000000	NOP
0000	000000	NOP
0000	BA1BB6	TBLRDL [W6++], [W7]
0000	000000	NOP
0000	000000	NOP

# dsPIC30F Flash Programming Specification

**TABLE 12-2: READING EXECUTIVE MEMORY (CONTINUED)**

Command (Binary)	Data (Hexadecimal)	Description
<b>Step 4: Output W0:W5 using the VISI register and REGOUT command.</b>		
0000	883C20	MOV W0, VISI
0000	000000	NOP
0001	—	Clock out contents of VISI register
0000	883C21	MOV W1, VISI
0000	000000	NOP
0001	—	Clock out contents of VISI register
0000	883C22	MOV W2, VISI
0000	000000	NOP
0001	—	Clock out contents of VISI register
0000	883C23	MOV W3, VISI
0000	000000	NOP
0001	—	Clock out contents of VISI register
0000	883C24	MOV W4, VISI
0000	000000	NOP
0001	—	Clock out contents of VISI register
0000	883C25	MOV W5, VISI
0000	000000	NOP
0001	—	Clock out contents of VISI register
<b>Step 5: Reset the device internal PC.</b>		
0000	040100	GOTO 0x100
0000	000000	NOP
<b>Step 6: Repeat Steps 3-5 until all 736 instruction words of executive memory are read.</b>		

# dsPIC30F Flash Programming Specification

## 13.0 AC/DC CHARACTERISTICS AND TIMING REQUIREMENTS

TABLE 13-1: AC/DC CHARACTERISTICS

AC/DC CHARACTERISTICS			Standard Operating Conditions (unless otherwise stated) Operating Temperature: 25° C is recommended			
Param. No.	Sym	Characteristic	Min	Max	Units	Conditions
D110	VIHH	High Programming Voltage on $\overline{\text{MCLR}}/\text{VPP}$	9.00	13.25	V	—
D112	IPP	Programming Current on $\overline{\text{MCLR}}/\text{VPP}$	—	300	$\mu\text{A}$	—
D113	IDDP	Supply Current during programming	—	30	mA	Row Erase Program memory
			—	30	mA	Row Erase Data EEPROM
			—	30	mA	Bulk Erase
D001	VDD	Supply voltage	2.5	5.5	V	—
D002	VDDBULK	Supply voltage for Bulk Erase programming	4.5	5.5	V	—
D031	VIL	Input Low Voltage	VSS	0.2 VSS	V	—
D041	VIH	Input High Voltage	0.8 VDD	VDD	V	—
D080	VOL	Output Low Voltage	—	0.6	V	IO <sub>L</sub> = 8.5 mA
D090	VOH	Output High Voltage	VDD - 0.7	—	V	IO <sub>H</sub> = -3.0 mA
D012	CIO	Capacitive Loading on I/O Pin (PGD)	—	50	pF	To meet AC specifications
P1	TSCLK	Serial Clock (PGC) period	50	—	ns	ICSP™ mode
			1	—	$\mu\text{s}$	Enhanced ICSP mode
P1a	TSCLKL	Serial Clock (PGC) low time	20	—	ns	ICSP mode
			400	—	ns	Enhanced ICSP mode
P1b	TSCLKH	Serial Clock (PGC) high time	20	—	ns	ICSP mode
			400	—	ns	Enhanced ICSP mode
P2	TSET1	Input Data Setup Timer to PGC ↓	15	—	ns	—
P3	THLD1	Input Data Hold Time from PGC ↓	15	—	ns	—
P4	TDLY1	Delay between 4-bit command and command operand	20	—	ns	—
P4a	TDLY1a	Delay between 4-bit command operand and next 4-bit command	20	—	ns	—
P5	TDLY2	Delay between last PGC ↓ of command to first PGC ↑ of VISI output	20	—	ns	—
P6	TSET2	VDD ↑ setup time to $\overline{\text{MCLR}}/\text{VPP}$	100	—	ns	—
P7	THLD2	Input data hold time from $\overline{\text{MCLR}}/\text{VPP}$ ↑	2	—	$\mu\text{s}$	ICSP mode
			5	—	ms	Enhanced ICSP mode
P8	TDLY3	Delay between last PGC ↓ of command word to PGD driven ↑ by programming executive	20	—	$\mu\text{s}$	—
P9a	TDLY4	Programming Executive Command processing time	10	—	$\mu\text{s}$	—

# dsPIC30F Flash Programming Specification

**TABLE 13-1: AC/DC CHARACTERISTICS (CONTINUED)**

AC/DC CHARACTERISTICS			Standard Operating Conditions (unless otherwise stated) Operating Temperature: 25° C is recommended			
Param. No.	Sym	Characteristic	Min	Max	Units	Conditions
P9b	TDLY5	Delay between PGD ↓ by programming executive to PGD released by programming executive	15	—	μs	—
P10	TDLY6	Delay between PGD released by programming executive to first PGC ↑ of response	5	—	μs	—
P11	TDLY7	Delay between clocking out response words	10	—	μs	—
P12a	TPROG	Row Programming cycle time	1	4	ms	ICSP mode
P12b	TPROG	Row Programming cycle time	0.8	2.6	ms	Enhanced ICSP mode
P13a	TERA	Bulk/Row Erase cycle time	1	4	ms	ICSP mode
P13b	TERA	Bulk/Row Erase cycle time	0.8	2.6	ms	Enhanced ICSP mode

# dsPIC30F Flash Programming Specification

## APPENDIX A: DEVICE-SPECIFIC INFORMATION

### A.1 Checksum Computation

The checksum computation is described in [Section 6.8 “Checksum Computation”](#). [Table A-1](#) shows how this 16-bit computation can be made for each dsPIC30F device. Computations for read code protection are shown both enabled and disabled. The checksum values assume that the Configuration registers are also erased. However, when code protection is enabled, the value of the FGS register is assumed to be 0x5.

## A.2 dsPIC30F5011 and dsPIC30F5013

### A.2.1 ICSP PROGRAMMING

The dsPIC30F5011 and dsPIC30F5013 processors require that the FBS and FSS registers be programmed with 0x0000 before the device is chip erased. The steps to perform this action are shown in [Table 11-4](#).

### A.2.2 ENHANCED ICSP PROGRAMMING

The dsPIC30F5011 and dsPIC30F5013 processors require that the FBS and FSS registers be programmed with 0x0000 using the `PROGC` command before the `ERASEB` command is used to erase the chip.

**TABLE A-1: CHECKSUM COMPUTATION**

Device	Read Code Protection	Checksum Computation	Erased Value	Value with 0xAAAAAA at 0x0 and Last Code Address
dsPIC30F2010	Disabled	CFGB+SUM(0:001FFF)	0xD406	0xD208
	Enabled	CFGB	0x0404	0x0404
dsPIC30F2011	Disabled	CFGB+SUM(0:001FFF)	0xD406	0xD208
	Enabled	CFGB	0x0404	0x0404
dsPIC30F2012	Disabled	CFGB+SUM(0:001FFF)	0xD406	0xD208
	Enabled	CFGB	0x0404	0x0404
dsPIC30F3010	Disabled	CFGB+SUM(0:003FFF)	0xA406	0xA208
	Enabled	CFGB	0x0404	0x0404
dsPIC30F3011	Disabled	CFGB+SUM(0:003FFF)	0xA406	0xA208
	Enabled	CFGB	0x0404	0x0404
dsPIC30F3012	Disabled	CFGB+SUM(0:003FFF)	0xA406	0xA208
	Enabled	CFGB	0x0404	0x0404
dsPIC30F3013	Disabled	CFGB+SUM(0:003FFF)	0xA406	0xA208
	Enabled	CFGB	0x0404	0x0404
dsPIC30F3014	Disabled	CFGB+SUM(0:003FFF)	0xA406	0xA208
	Enabled	CFGB	0x0404	0x0404
dsPIC30F4011	Disabled	CFGB+SUM(0:007FFF)	0x4406	0x4208
	Enabled	CFGB	0x0404	0x0404
dsPIC30F4012	Disabled	CFGB+SUM(0:007FFF)	0x4406	0x4208
	Enabled	CFGB	0x0404	0x0404
dsPIC30F4013	Disabled	CFGB+SUM(0:007FFF)	0x4406	0x4208
	Enabled	CFGB	0x0404	0x0404
dsPIC30F5011	Disabled	CFGB+SUM(0:00AFFF)	0xFC06	0xFA08
	Enabled	CFGB	0x0404	0x0404
dsPIC30F5013	Disabled	CFGB+SUM(0:00AFFF)	0xFC06	0xFA08
	Enabled	CFGB	0x0404	0x0404
dsPIC30F5015	Disabled	CFGB+SUM(0:00AFFF)	0xFC06	0xFA08
	Enabled	CFGB	0x0404	0x0404

**Item Description:**

**SUM(a:b)** = Byte sum of locations a to b inclusive (all 3 bytes of code memory)

**CFGB** = **Configuration Block (masked)** = Byte sum of ((FOSC&0xC10F) + (FWDT&0x803F) + (FBORPOR&0x87B3) + (FBS&0x310F) + (FSS&0x330F) + (FGS&0x0007) + (FICD&0xC003))

# dsPIC30F Flash Programming Specification

**TABLE A-1: CHECKSUM COMPUTATION (CONTINUED)**

Device	Read Code Protection	Checksum Computation	Erased Value	Value with 0xAAAAAA at 0x0 and Last Code Address
dsPIC30F5016	Disabled	CFGB+SUM(0:00AFFF)	0xFC06	0xFA08
	Enabled	CFGB	0x0404	0x0404
dsPIC30F6010	Disabled	CFGB+SUM(0:017FFF)	0xC406	0xC208
	Enabled	CFGB	0x0404	0x0404
dsPIC30F6010A	Disabled	CFGB+SUM(0:017FFF)	0xC406	0xC208
	Enabled	CFGB	0x0404	0x0404
dsPIC30F6011	Disabled	CFGB+SUM(0:015FFF)	0xF406	0xF208
	Enabled	CFGB	0x0404	0x0404
dsPIC30F6011A	Disabled	CFGB+SUM(0:015FFF)	0xF406	0xF208
	Enabled	CFGB	0x0404	0x0404
dsPIC30F6012	Disabled	CFGB+SUM(0:017FFF)	0xC406	0xC208
	Enabled	CFGB	0x0404	0x0404
dsPIC30F6012A	Disabled	CFGB+SUM(0:017FFF)	0xC406	0xC208
	Enabled	CFGB	0x0404	0x0404
dsPIC30F6013	Disabled	CFGB+SUM(0:015FFF)	0xF406	0xF208
	Enabled	CFGB	0x0404	0x0404
dsPIC30F6013A	Disabled	CFGB+SUM(0:015FFF)	0xF406	0xF208
	Enabled	CFGB	0x0404	0x0404
dsPIC30F6014	Disabled	CFGB+SUM(0:017FFF)	0xC406	0xC208
	Enabled	CFGB	0x0404	0x0404
dsPIC30F6014A	Disabled	CFGB+SUM(0:017FFF)	0xC406	0xC208
	Enabled	CFGB	0x0404	0x0404
dsPIC30F6015	Disabled	CFGB+SUM(0:017FFF)	0xC406	0xC208
	Enabled	CFGB	0x0404	0x0404

**Item Description:**

**SUM(a:b)** = Byte sum of locations a to b inclusive (all 3 bytes of code memory)

**CFGB** = **Configuration Block (masked)** = Byte sum of ((FOSC&0xC10F) + (FWDT&0x803F) + (FBORPOR&0x87B3) + (FBS&0x310F) + (FSS&0x330F) + (FGS&0x0007) + (FICD&0xC003))

# dsPIC30F Flash Programming Specification

---

## APPENDIX B: HEX FILE FORMAT

Flash programmers process the standard HEX format used by the Microchip development tools. The format supported is the Intel® HEX 32 Format (INHX32). Please refer to Appendix A in the “*MPASM User's Guide*” (DS33014) for more information about hex file formats.

The basic format of the hex file is:

```
:BBAAAATTHHHH...HHHCC
```

Each data record begins with a 9-character prefix and always ends with a 2-character checksum. All records begin with ':' regardless of the format. The individual elements are described below.

- **BB** - is a two-digit hexadecimal byte count representing the number of data bytes that appear on the line. Divide this number by two to get the number of words per line.
- **AAAA** - is a four-digit hexadecimal address representing the starting address of the data record. Format is high byte first followed by low byte. The address is doubled because this format only supports 8-bits. Divide the value by two to find the real device address.
- **TT** - is a two-digit record type that will be '00' for data records, '01' for end-of-file records and '04' for extended-address record.
- **HHHH** - is a four-digit hexadecimal data word. Format is low byte followed by high byte. There will be  $BB/2$  data words following **TT**.
- **CC** - is a two-digit hexadecimal checksum that is the two's complement of the sum of all the preceding bytes in the line record.

Because the Intel hex file format is byte-oriented, and the 16-bit program counter is not, program memory sections require special treatment. Each 24-bit program word is extended to 32 bits by inserting a so-called “phantom byte”. Each program memory address is multiplied by 2 to yield a byte address.

As an example, a section that is located at 0x100 in program memory will be represented in the hex file as 0x200.

The hex file will be produced with the following contents:

```
:020000040000fa  
:040200003322110096  
:00000001FF
```

Notice that the data record (line 2) has a load address of 0200, while the source code specified address 0x100. Note also that the data is represented in “little-endian” format, meaning the Least Significant Byte (LSB) appears first. The phantom byte appears last, just before the checksum.

# dsPIC30F Flash Programming Specification

---

---

## APPENDIX C: REVISION HISTORY

**Note:** Revision histories were not recorded for revisions A through H. The previous revision (J), was published in August 2007.

### Revision K (November 2010)

This version of the document includes the following updates:

- Added Note three to [Section 5.2 “Entering Enhanced ICSP Mode”](#)
- Updated the first paragraph of [Section 10.0 “Device ID”](#)
- Updated [Table 10-1: Device IDs](#)
- Removed the VARIANT bit and updated the bit definition for the DEVID register in [Table 10-2: dsPIC30F Device ID Registers](#)
- Removed the VARIANT bit and updated the bit field definition and description for the DEVID register in [Table 10-3: Device ID Bits Description](#)
- Updated Note 3 in [Section 11.3 “Entering ICSP Mode”](#)
- Updated Step 11 in [Table 11-4: Serial Instruction Execution for Bulk Erasing Program Memory \(Only in Normal-voltage Systems\)](#)
- Updated Steps 5, 12 and 19 in [Table 11-5: Serial Instruction Execution for Erasing Program Memory \(Either in Low-voltage or Normal-voltage Systems\)](#)
- Updated Steps 5, 6 and 8 in [Table 11-7: Serial Instruction Execution for Writing Configuration Registers](#)
- Updated Steps 6 and 8 in [Table 11-8: Serial Instruction Execution for Writing Code Memory](#)
- Updated Steps 6 and 8 in [Table 11-9: Serial Instruction Execution for Writing Data EEPROM](#)
- Updated Entering ICSP™ Mode (see [Figure 11-4](#))
- Updated Steps 4 and 11 in [Table 12-1: Programming the Programming Executive](#)
- Renamed parameters: P12 to P12a and P13 to P13a, and added parameters P12b and P13b in [Table 13-1: AC/DC Characteristics](#)

# dsPIC30F Flash Programming Specification

---

---

NOTES:

---

**Note the following details of the code protection feature on Microchip devices:**

- Microchip products meet the specification contained in their particular Microchip Data Sheet.
- Microchip believes that its family of products is one of the most secure families of its kind on the market today, when used in the intended manner and under normal conditions.
- There are dishonest and possibly illegal methods used to breach the code protection feature. All of these methods, to our knowledge, require using the Microchip products in a manner outside the operating specifications contained in Microchip's Data Sheets. Most likely, the person doing so is engaged in theft of intellectual property.
- Microchip is willing to work with the customer who is concerned about the integrity of their code.
- Neither Microchip nor any other semiconductor manufacturer can guarantee the security of their code. Code protection does not mean that we are guaranteeing the product as “unbreakable.”

Code protection is constantly evolving. We at Microchip are committed to continuously improving the code protection features of our products. Attempts to break Microchip's code protection feature may be a violation of the Digital Millennium Copyright Act. If such acts allow unauthorized access to your software or other copyrighted work, you may have a right to sue for relief under that Act.

---

Information contained in this publication regarding device applications and the like is provided only for your convenience and may be superseded by updates. It is your responsibility to ensure that your application meets with your specifications. MICROCHIP MAKES NO REPRESENTATIONS OR WARRANTIES OF ANY KIND WHETHER EXPRESS OR IMPLIED, WRITTEN OR ORAL, STATUTORY OR OTHERWISE, RELATED TO THE INFORMATION, INCLUDING BUT NOT LIMITED TO ITS CONDITION, QUALITY, PERFORMANCE, MERCHANTABILITY OR FITNESS FOR PURPOSE. Microchip disclaims all liability arising from this information and its use. Use of Microchip devices in life support and/or safety applications is entirely at the buyer's risk, and the buyer agrees to defend, indemnify and hold harmless Microchip from any and all damages, claims, suits, or expenses resulting from such use. No licenses are conveyed, implicitly or otherwise, under any Microchip intellectual property rights.

**Trademarks**

The Microchip name and logo, the Microchip logo, dsPIC, KEELOQ, KEELOQ logo, MPLAB, PIC, PICmicro, PICSTART, PIC<sup>32</sup> logo, rPIC and UNI/O are registered trademarks of Microchip Technology Incorporated in the U.S.A. and other countries.

FilterLab, Hampshire, HI-TECH C, Linear Active Thermistor, MXDEV, MXLAB, SEEVAL and The Embedded Control Solutions Company are registered trademarks of Microchip Technology Incorporated in the U.S.A.

Analog-for-the-Digital Age, Application Maestro, CodeGuard, dsPICDEM, dsPICDEM.net, dsPICworks, dsSPEAK, ECAN, ECONOMONITOR, FanSense, HI-TIDE, In-Circuit Serial Programming, ICSP, Mindi, MiWi, MPASM, MPLAB Certified logo, MPLIB, MPLINK, mTouch, Omniscient Code Generation, PICC, PICC-18, PICDEM, PICDEM.net, PICkit, PICTail, REAL ICE, rLAB, Select Mode, Total Endurance, TSHARC, UniWinDriver, WiperLock and ZENA are trademarks of Microchip Technology Incorporated in the U.S.A. and other countries.

SQTP is a service mark of Microchip Technology Incorporated in the U.S.A.

All other trademarks mentioned herein are property of their respective companies.

© 2010, Microchip Technology Incorporated, Printed in the U.S.A., All Rights Reserved.

 Printed on recycled paper.

ISBN: 978-1-60932-636-4

*Microchip received ISO/TS-16949:2002 certification for its worldwide headquarters, design and wafer fabrication facilities in Chandler and Tempe, Arizona; Gresham, Oregon and design centers in California and India. The Company's quality system processes and procedures are for its PIC<sup>®</sup> MCUs and dsPIC<sup>®</sup> DSCs, KEELOQ<sup>®</sup> code hopping devices, Serial EEPROMs, microperipherals, nonvolatile memory and analog products. In addition, Microchip's quality system for the design and manufacture of development systems is ISO 9001:2000 certified.*

---

**QUALITY MANAGEMENT SYSTEM  
CERTIFIED BY DNV  
== ISO/TS 16949:2002 ==**



# MICROCHIP

## Worldwide Sales and Service

### AMERICAS

**Corporate Office**  
2355 West Chandler Blvd.  
Chandler, AZ 85224-6199  
Tel: 480-792-7200  
Fax: 480-792-7277  
Technical Support:  
<http://support.microchip.com>  
Web Address:  
[www.microchip.com](http://www.microchip.com)

**Atlanta**  
Duluth, GA  
Tel: 678-957-9614  
Fax: 678-957-1455

**Boston**  
Westborough, MA  
Tel: 774-760-0087  
Fax: 774-760-0088

**Chicago**  
Itasca, IL  
Tel: 630-285-0071  
Fax: 630-285-0075

**Cleveland**  
Independence, OH  
Tel: 216-447-0464  
Fax: 216-447-0643

**Dallas**  
Addison, TX  
Tel: 972-818-7423  
Fax: 972-818-2924

**Detroit**  
Farmington Hills, MI  
Tel: 248-538-2250  
Fax: 248-538-2260

**Kokomo**  
Kokomo, IN  
Tel: 765-864-8360  
Fax: 765-864-8387

**Los Angeles**  
Mission Viejo, CA  
Tel: 949-462-9523  
Fax: 949-462-9608

**Santa Clara**  
Santa Clara, CA  
Tel: 408-961-6444  
Fax: 408-961-6445

**Toronto**  
Mississauga, Ontario,  
Canada  
Tel: 905-673-0699  
Fax: 905-673-6509

### ASIA/PACIFIC

**Asia Pacific Office**  
Suites 3707-14, 37th Floor  
Tower 6, The Gateway  
Harbour City, Kowloon  
Hong Kong  
Tel: 852-2401-1200  
Fax: 852-2401-3431

**Australia - Sydney**  
Tel: 61-2-9868-6733  
Fax: 61-2-9868-6755

**China - Beijing**  
Tel: 86-10-8528-2100  
Fax: 86-10-8528-2104

**China - Chengdu**  
Tel: 86-28-8665-5511  
Fax: 86-28-8665-7889

**China - Chongqing**  
Tel: 86-23-8980-9588  
Fax: 86-23-8980-9500

**China - Hong Kong SAR**  
Tel: 852-2401-1200  
Fax: 852-2401-3431

**China - Nanjing**  
Tel: 86-25-8473-2460  
Fax: 86-25-8473-2470

**China - Qingdao**  
Tel: 86-532-8502-7355  
Fax: 86-532-8502-7205

**China - Shanghai**  
Tel: 86-21-5407-5533  
Fax: 86-21-5407-5066

**China - Shenyang**  
Tel: 86-24-2334-2829  
Fax: 86-24-2334-2393

**China - Shenzhen**  
Tel: 86-755-8203-2660  
Fax: 86-755-8203-1760

**China - Wuhan**  
Tel: 86-27-5980-5300  
Fax: 86-27-5980-5118

**China - Xian**  
Tel: 86-29-8833-7252  
Fax: 86-29-8833-7256

**China - Xiamen**  
Tel: 86-592-2388138  
Fax: 86-592-2388130

**China - Zhuhai**  
Tel: 86-756-3210040  
Fax: 86-756-3210049

### ASIA/PACIFIC

**India - Bangalore**  
Tel: 91-80-3090-4444  
Fax: 91-80-3090-4123

**India - New Delhi**  
Tel: 91-11-4160-8631  
Fax: 91-11-4160-8632

**India - Pune**  
Tel: 91-20-2566-1512  
Fax: 91-20-2566-1513

**Japan - Yokohama**  
Tel: 81-45-471- 6166  
Fax: 81-45-471-6122

**Korea - Daegu**  
Tel: 82-53-744-4301  
Fax: 82-53-744-4302

**Korea - Seoul**  
Tel: 82-2-554-7200  
Fax: 82-2-558-5932 or  
82-2-558-5934

**Malaysia - Kuala Lumpur**  
Tel: 60-3-6201-9857  
Fax: 60-3-6201-9859

**Malaysia - Penang**  
Tel: 60-4-227-8870  
Fax: 60-4-227-4068

**Philippines - Manila**  
Tel: 63-2-634-9065  
Fax: 63-2-634-9069

**Singapore**  
Tel: 65-6334-8870  
Fax: 65-6334-8850

**Taiwan - Hsin Chu**  
Tel: 886-3-6578-300  
Fax: 886-3-6578-370

**Taiwan - Kaohsiung**  
Tel: 886-7-213-7830  
Fax: 886-7-330-9305

**Taiwan - Taipei**  
Tel: 886-2-2500-6610  
Fax: 886-2-2508-0102

**Thailand - Bangkok**  
Tel: 66-2-694-1351  
Fax: 66-2-694-1350

### EUROPE

**Austria - Wels**  
Tel: 43-7242-2244-39  
Fax: 43-7242-2244-393

**Denmark - Copenhagen**  
Tel: 45-4450-2828  
Fax: 45-4485-2829

**France - Paris**  
Tel: 33-1-69-53-63-20  
Fax: 33-1-69-30-90-79

**Germany - Munich**  
Tel: 49-89-627-144-0  
Fax: 49-89-627-144-44

**Italy - Milan**  
Tel: 39-0331-742611  
Fax: 39-0331-466781

**Netherlands - Drunen**  
Tel: 31-416-690399  
Fax: 31-416-690340



**Spain - Madrid**  
Tel: 34-91-708-08-90  
Fax: 34-91-708-08-91

**UK - Wokingham**  
Tel: 44-118-921-5869  
Fax: 44-118-921-5820

08/04/10

## Looking for pricing, stock, or lifecycle information?

Click below to explore more details on WIN SOURCE:

-  [View DSPIC30F3014-30I/PT on WIN SOURCE](#)
-  [Microchip Technology](#) Information

## Optimize Your Supply Chain with WIN SOURCE Solutions

-  Global Sourcing Solution
-  Obsolete Management
-  Cost Control Management
-  Shortage Management
-  Alternative Solution
-  Excess Inventory Management