



FW389

Power MOSFET

100V, 2A, 225mΩ, -100V, -2A, 300mΩ, Complementary Dual SOIC8

ON Semiconductor®

<http://onsemi.com>

Features

- ON-resistance Nch : $R_{DS(on)1}=165m\Omega$ (typ.)
Pch : $R_{DS(on)1}=230m\Omega$ (typ.)
- Input Capacitance Nch : $C_{iss}=490pF$ (typ.)
Pch : $C_{iss}=1000pF$ (typ.)
- 4V drive
- Halogen free compliance
- Protection diode in

Specifications

Absolute Maximum Ratings at $T_a=25^\circ C$

Parameter	Symbol	Conditions	N-channel	P-channel	Unit
Drain-to-Source Voltage	V_{DSS}		100	-100	V
Gate-to-Source Voltage	V_{GSS}		± 20	± 20	V
Drain Current (DC)	I_D		2	-2	A
Drain Current ($PW \leq 100ms$)	I_{DP}	Duty cycle $\leq 1\%$	5	-5	A
Drain Current ($PW \leq 10\mu s$)	I_{DP}	Duty cycle $\leq 1\%$	8	-8	A
Allowable Power Dissipation	P_D	When mounted on ceramic substrate (2000mm ² ×0.8mm) 1unit, ($PW \leq 10s$)	1.8		W
Total Dissipation	P_T	When mounted on ceramic substrate (2000mm ² ×0.8mm), ($PW \leq 10s$)	2.2		W
Channel Temperature	T_{ch}		150		$^\circ C$
Storage Temperature	T_{stg}		-55 to +150		$^\circ C$
Avalanche Energy (Single Pulse) *1	E_{AS}		5.3	5.3	mJ
Avalanche Current *2	I_{AV}		2	-2	A

*1 N-Channel: $V_{DD}=10V$, $L=2mH$, $I_{AV}=2A$ (Fig.1)

P-Channel: $V_{DD}=-10V$, $L=2mH$, $I_{AV}=-2A$ (Fig.1)

*2 $L \leq 2mH$, single pulse

Stresses exceeding Maximum Ratings may damage the device. Maximum Ratings are stress ratings only. Functional operation above the Recommended Operating Conditions is not implied. Extended exposure to stresses above the Recommended Operating Conditions may affect device reliability.

Electrical Characteristics at $T_a=25^\circ C$

Parameter	Symbol	Conditions	Ratings			Unit	
			min	typ	max		
[N-channel]							
Drain-to-Source Breakdown Voltage	$V_{(BR)DSS}$	$I_D=1mA$, $V_{GS}=0V$	100			V	
Zero-Gate Voltage Drain Current	I_{DSS}	$V_{DS}=100V$, $V_{GS}=0V$			1	μA	
Gate-to-Source Leakage Current	I_{GSS}	$V_{GS}=\pm 16V$, $V_{DS}=0V$			± 10	μA	
Cutoff Voltage	$V_{GS(off)}$	$V_{DS}=10V$, $I_D=1mA$	1.5		2.6	V	
Forward Transfer Admittance	$ y_{fs} $	$V_{DS}=10V$, $I_D=2A$		2.9		S	
Static Drain-to-Source On-State Resistance	$R_{DS(on)1}$	$I_D=2A$, $V_{GS}=10V$		165	225	$m\Omega$	
	$R_{DS(on)2}$	$I_D=1A$, $V_{GS}=4.5V$		180	254	$m\Omega$	
	$R_{DS(on)3}$	$I_D=1A$, $V_{GS}=4V$		190	275	$m\Omega$	
Input Capacitance	C_{iss}	$V_{DS}=10V$, $f=1MHz$		490		pF	
Output Capacitance	C_{oss}			34		pF	
Reverse Transfer Capacitance	C_{rss}			13		pF	
Turn-ON Delay Time	$t_d(on)$		See specified Test Circuit.		9.3		ns
Rise Time	t_r				5.4		ns
Turn-OFF Delay Time	$t_d(off)$				42		ns
Fall Time	t_f				26		ns

Continued on next page.

ORDERING INFORMATION

See detailed ordering and shipping information on page 7 of this data sheet.

Continued from preceding page

Electrical Characteristics at Ta=25°C

Parameter	Symbol	Conditions	Ratings			Unit
			min	typ	max	
[N-channel]						
Total Gate Charge	Qg	V _{DS} =50V, V _{GS} =10V, I _D =2A		10		nC
Gate-to-Source Charge	Qgs			1.4		nC
Gate-to-Drain "Miller" Charge	Qgd			2.1		nC
Diode Forward Voltage	VSD	I _S =2A, V _{GS} =0V		0.78	1.2	V
Gata Resistance	Rg	V _{DS} =0V, V _{GS} =0V, f=1MHz	0		12	Ω
[P-channel]						
Drain-to-Source Breakdown Voltage	V _{(BR)DSS}	I _D =-1mA, V _{GS} =0V	-100			V
Zero-Gate Voltage Drain Current	I _{DSS}	V _{DS} =-100V, V _{GS} =0V			-1	μA
Gate-to-Source Leakage Current	I _{GSS}	V _{GS} =±16V, V _{DS} =0V			±10	μA
Cutoff Voltage	V _{GS(off)}	V _{DS} =-10V, I _D =-1mA	-1.2		-2.6	V
Forward Transfer Admittance	y _{fs}	V _{DS} =-10V, I _D =-2A		4.7		S
Static Drain-to-Source On-State Resistance	R _{DS(on)1}	I _D =-2A, V _{GS} =-10V		230	300	mΩ
	R _{DS(on)2}	I _D =-1A, V _{GS} =-4.5V		240	336	mΩ
	R _{DS(on)3}	I _D =-1A, V _{GS} =-4V		250	355	mΩ
Input Capacitance	C _{iss}	V _{DS} =-20V, f=1MHz		1000		pF
Output Capacitance	C _{oss}			77		pF
Reverse Transfer Capacitance	C _{rss}			47		pF
Turn-ON Delay Time	t _{d(on)}	See specified Test Circuit.		12		ns
Rise Time	t _r			16		ns
Turn-OFF Delay Time	t _{d(off)}			110		ns
Fall Time	t _f			40		ns
Total Gate Charge	Qg				21	
Gate-to-Source Charge	Qgs	V _{DS} =-50V, V _{GS} =-10V, I _D =-2A		2.8		nC
Gate-to-Drain "Miller" Charge	Qgd			4.4		nC
Diode Forward Voltage	VSD	I _S =-2A, V _{GS} =0V		-0.79	-1.2	V
Gata Resistance	Rg	V _{DS} =0V, V _{GS} =0V, f=1MHz	0		50	Ω

Fig.1 Unclamped Inductive Switching Test Circuit

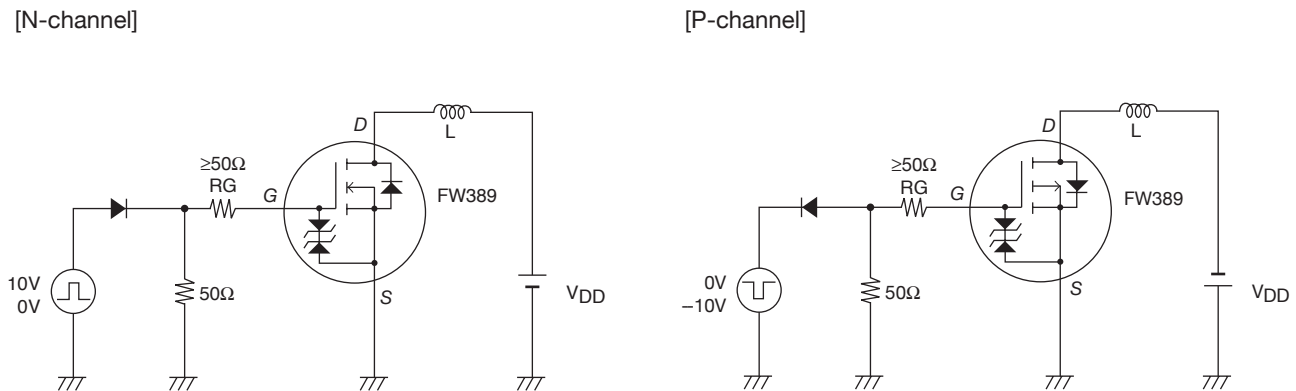
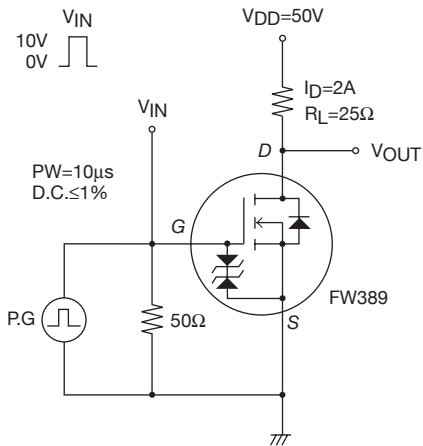
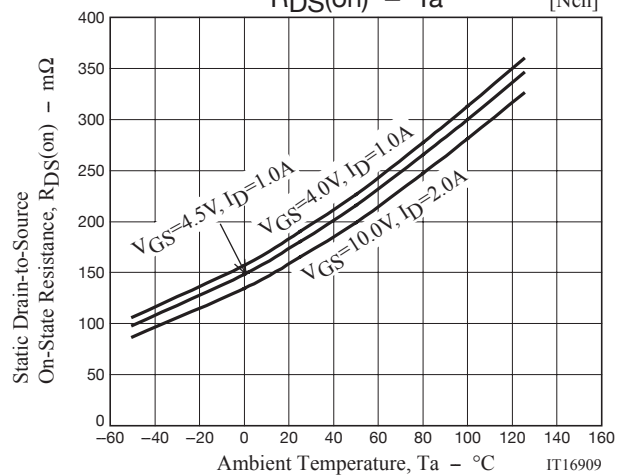
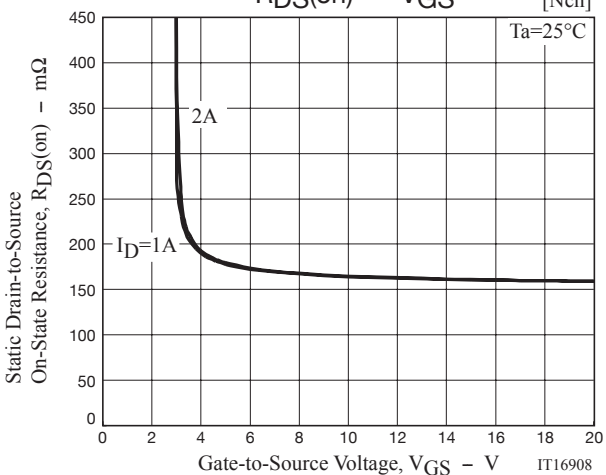
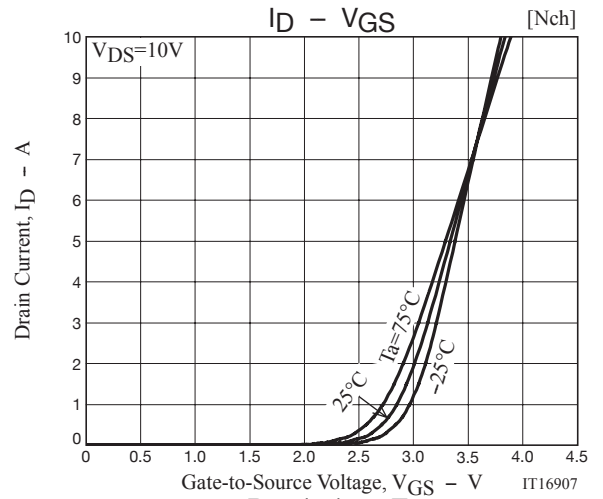
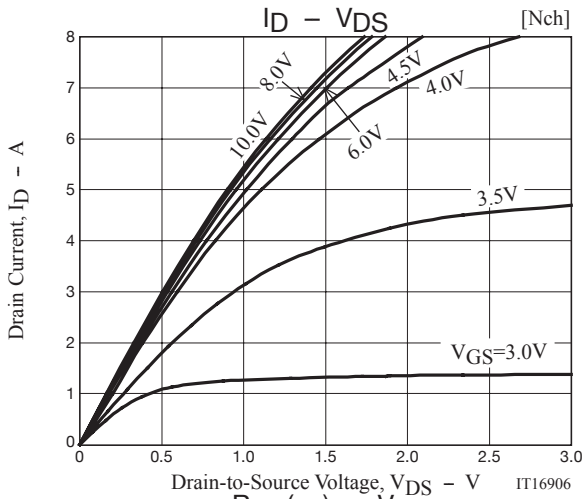
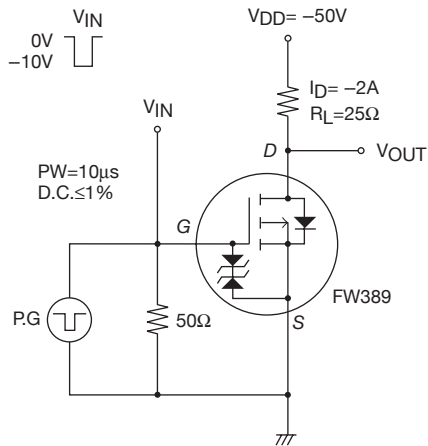

Fig.2 Switching Time Test Circuit

[N-channel]



[P-channel]



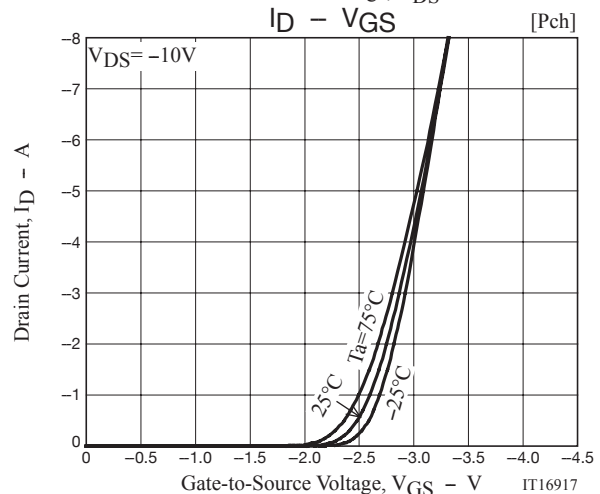
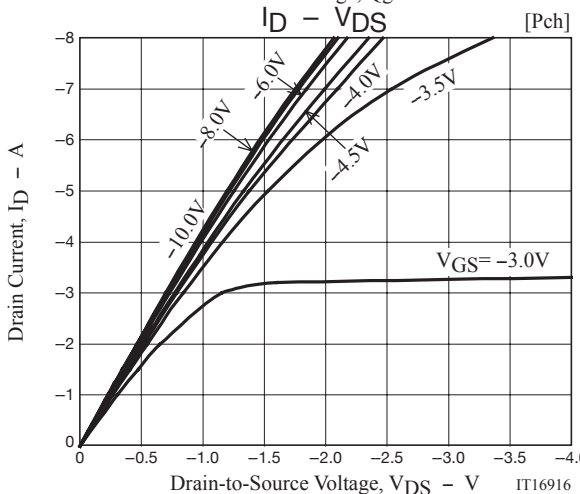
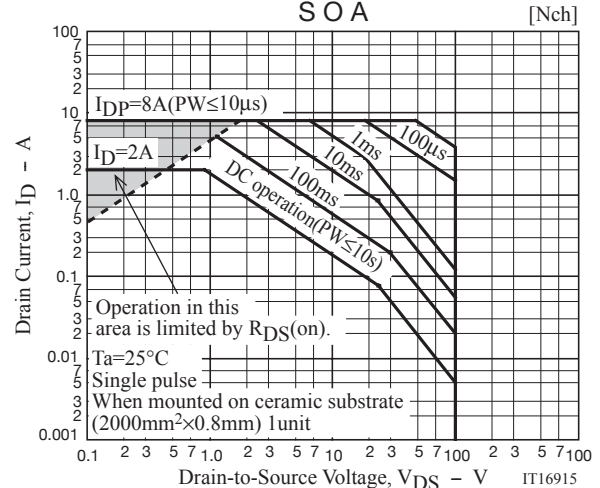
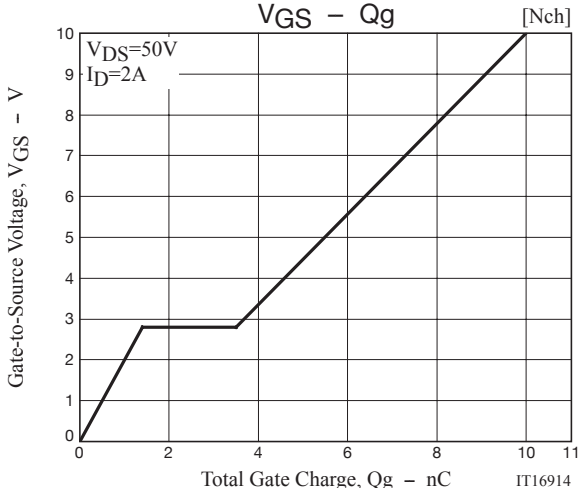
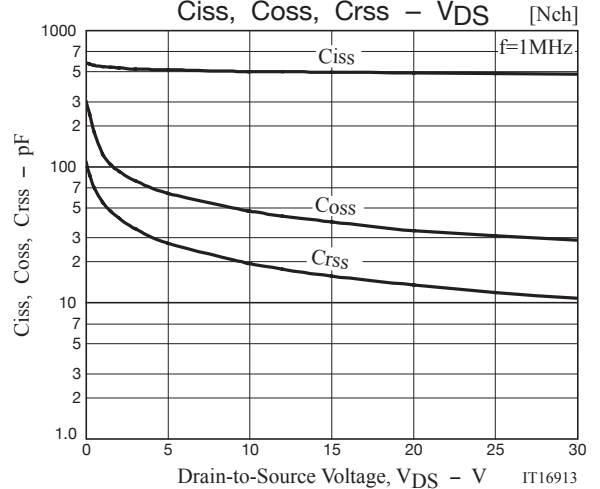
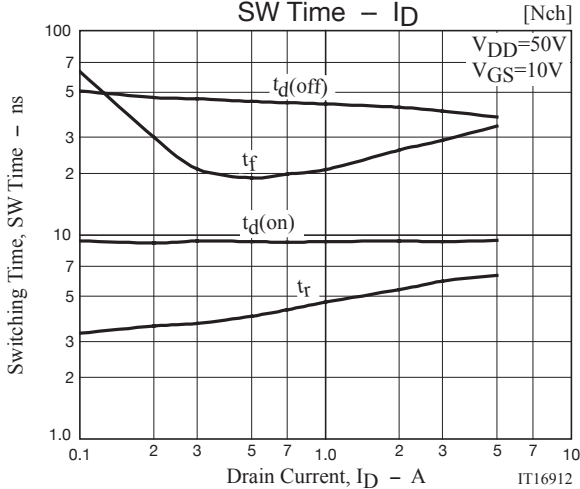
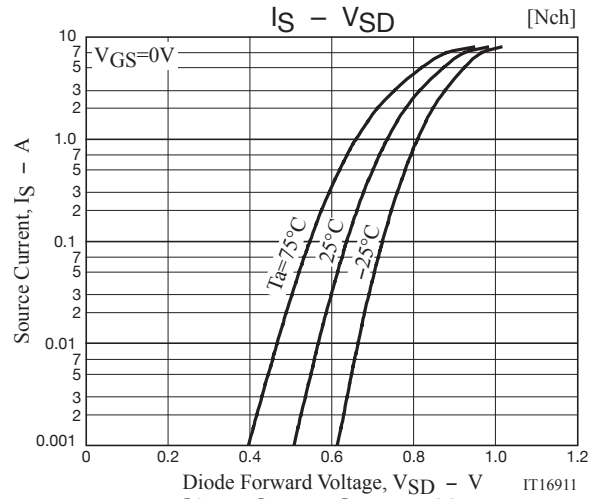
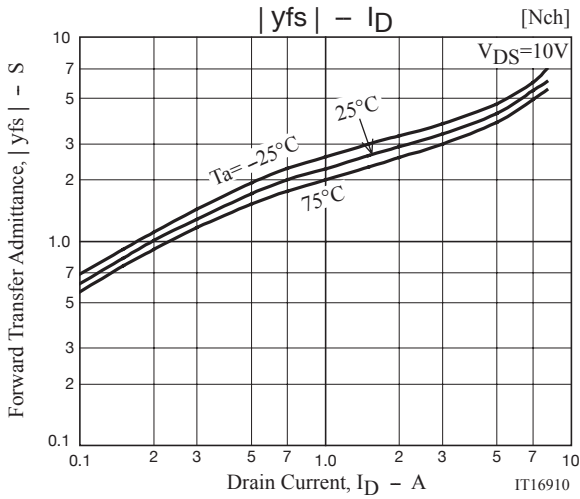

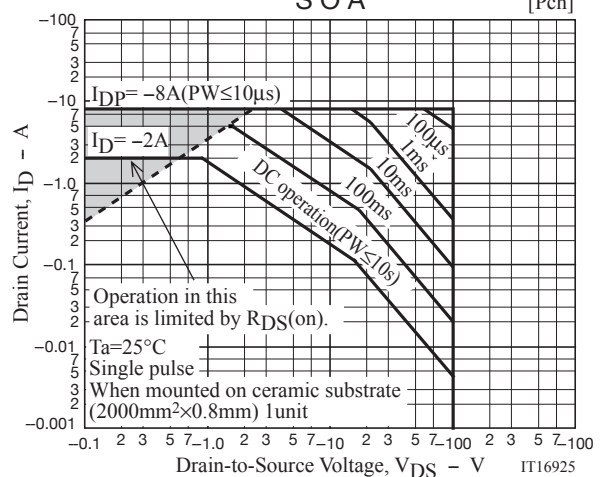
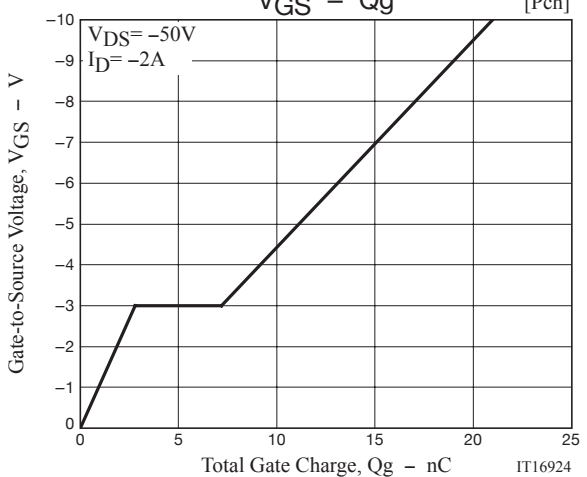
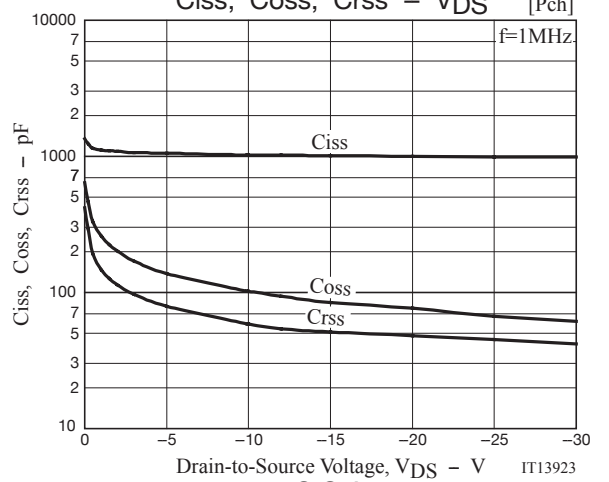
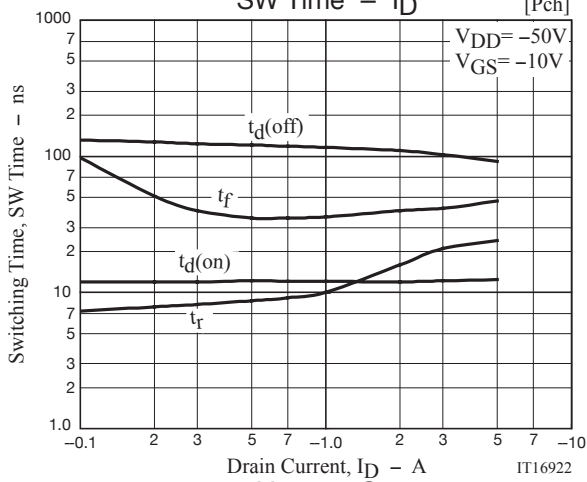
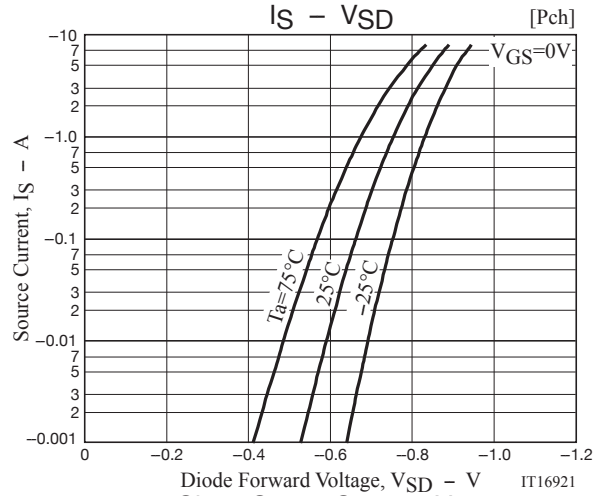
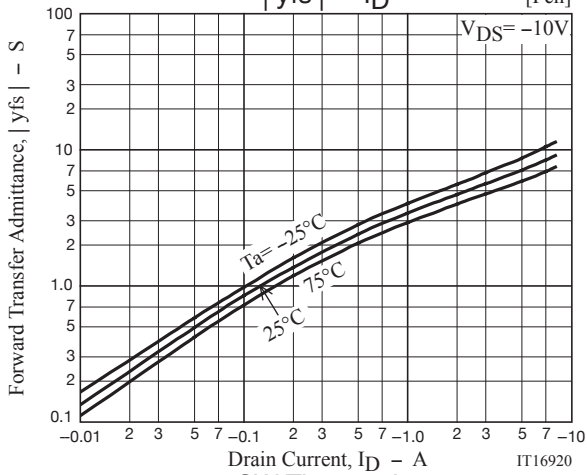
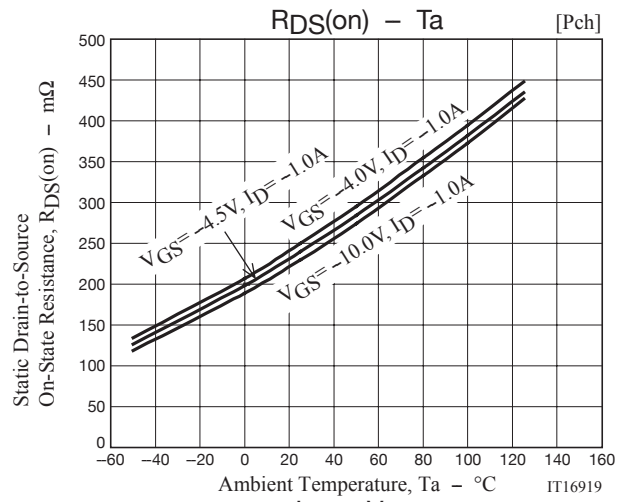
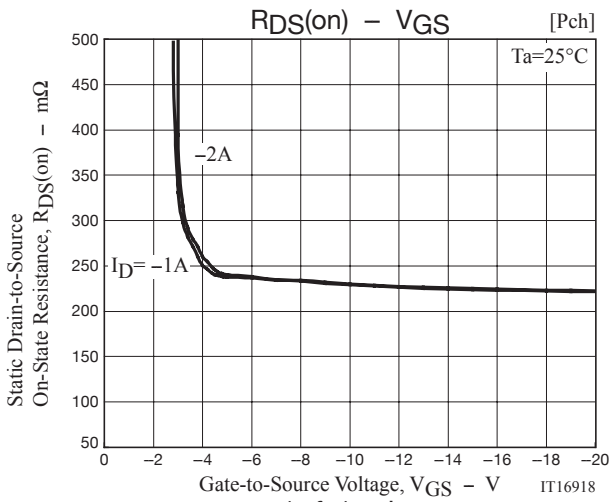

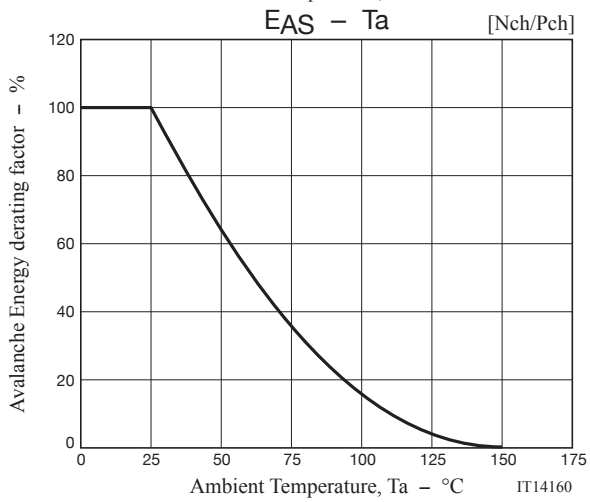
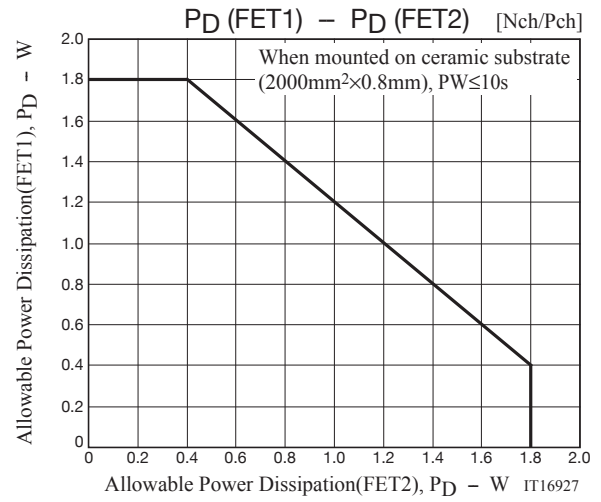
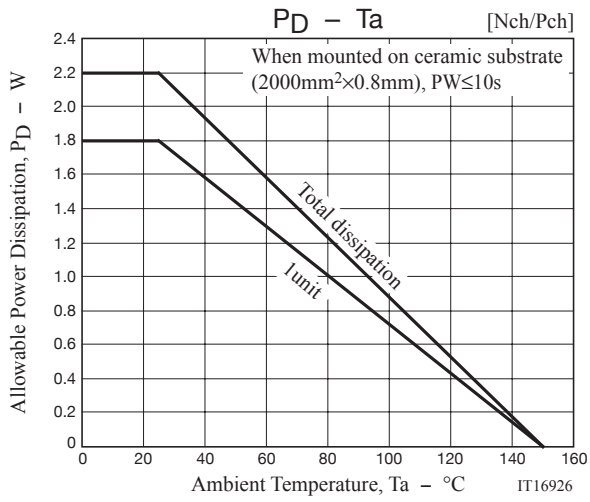

FW389

Package Dimensions

FW389-TL-2W

SOIC-8

CASE 751CR

ISSUE O

unit : mm

1:Source1

2:Gate1

3:Source2

4:Gate2

5:Drain

6:Drain

7:Drain

8:Drain

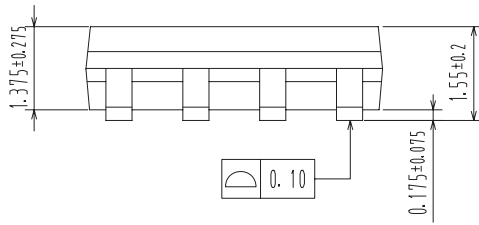
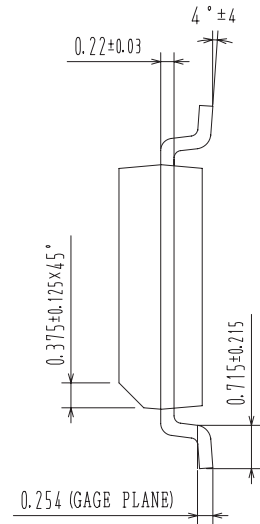
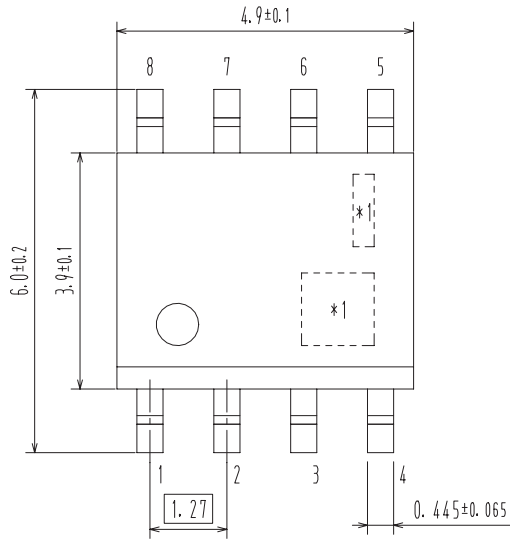

*1:Lot Indication,

*2:Lot Indication, Some products have no Lot indication.

Land Pattern Example

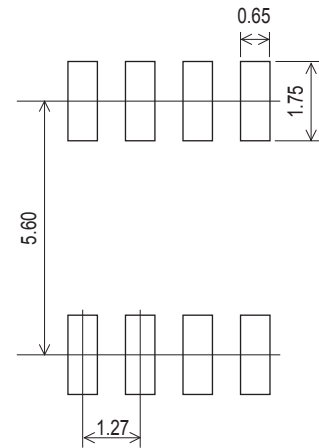

Ordering & Package Information

Device	Package	Shipping	note
FW389-TL-2W	SOIC8, SC-87, SOT-96	2,500 pcs. / reel	Pb-Free and Halogen Free

Packing Type:TL

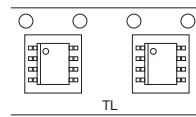

Marking

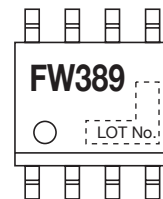

Electrical Connection

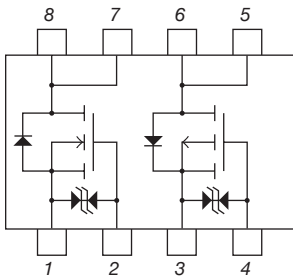

Note on usage : Since the FW389 is a MOSFET product, please avoid using this device in the vicinity of highly charged objects.

ON Semiconductor and the ON logo are registered trademarks of Semiconductor Components Industries, LLC (SCILLC). SCILLC owns the rights to a number of patents, trademarks, copyrights, trade secrets, and other intellectual property. A listing of SCILLC's product/patent coverage may be accessed at www.onsemi.com/site/pdf/Patent-Marking.pdf. SCILLC reserves the right to make changes without further notice to any products herein. SCILLC makes no warranty, representation or guarantee regarding the suitability of its products for any particular purpose, nor does SCILLC assume any liability arising out of the application or use of any product or circuit, and specifically disclaims any and all liability, including without limitation special, consequential or incidental damages. "Typical" parameters which may be provided in SCILLC data sheets and/or specifications can and do vary in different applications and actual performance may vary over time. All operating parameters, including "Typicals" must be validated for each customer application by customer's technical experts. SCILLC does not convey any license under its patent rights nor the rights of others. SCILLC products are not designed, intended, or authorized for use as components in systems intended for surgical implant into the body, or other applications intended to support or sustain life, or for any other application in which the failure of the SCILLC product could create a situation where personal injury or death may occur. Should Buyer purchase or use SCILLC products for any such unintended or unauthorized application, Buyer shall indemnify and hold SCILLC and its officers, employees, subsidiaries, affiliates, and distributors harmless against all claims, costs, damages, and expenses, and reasonable attorney fees arising out of, directly or indirectly, any claim of personal injury or death associated with such unintended or unauthorized use, even if such claim alleges that SCILLC was negligent regarding the design or manufacture of the part. SCILLC is an Equal Opportunity/Affirmative Action Employer. This literature is subject to all applicable copyright laws and is not for resale in any manner.

Looking for pricing, stock, or lifecycle information?

Click below to explore more details on WIN SOURCE:

- ⊖ [View FW389-TL-2W on WIN SOURCE](#)
- ⊖ [ON Semiconductor](#) Information

Optimize Your Supply Chain with WIN SOURCE Solutions

- ✓ Global Sourcing Solution
- ✓ Obsolete Management
- ✓ Cost Control Management
- ✓ Shortage Management
- ✓ Alternative Solution
- ✓ Excess Inventory Management