

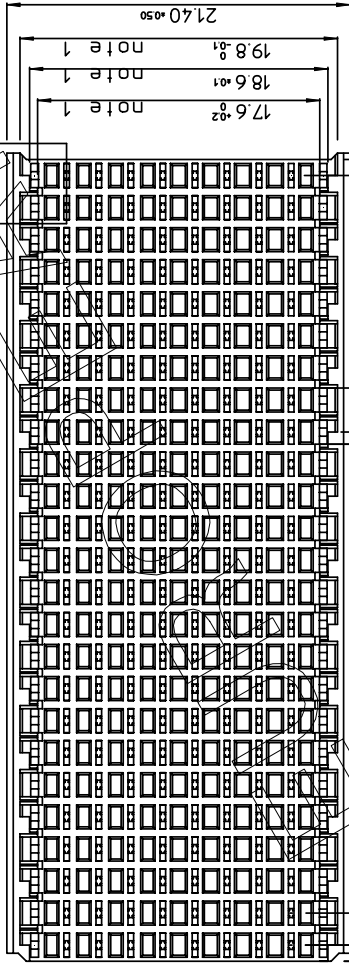

**THE DATASHEET OF  
HM2H88P115LF**

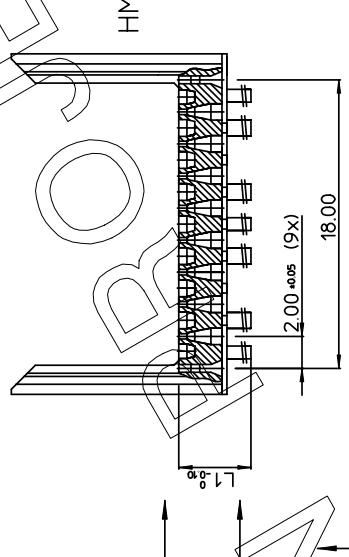

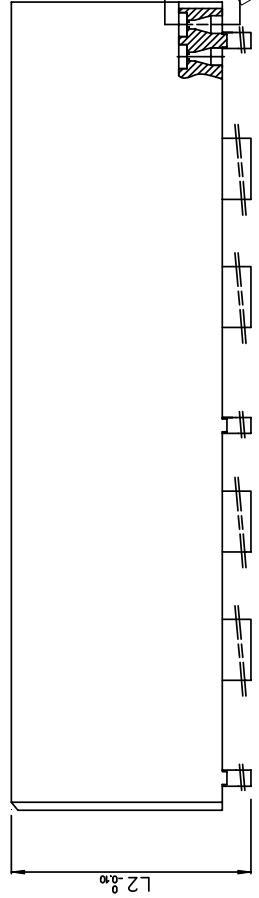
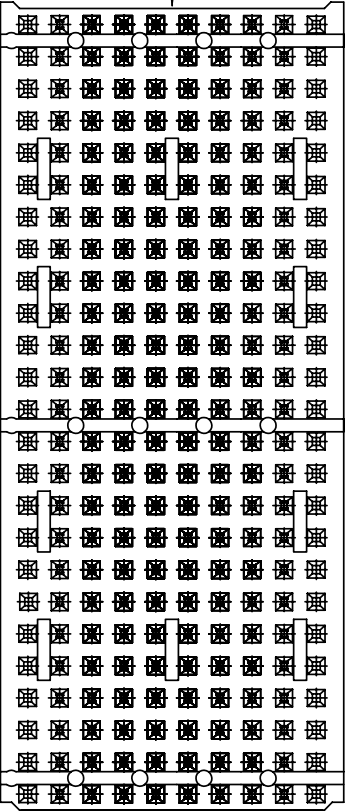

PART NUMBER
HM2H88P11LF
HM2H88P109LF
HM2H88P111LF
HM2H88P115LF
HM2H88P117LF
HM2H88P119LF
HM2H88P122LF
HM2H88P130LF

- NOTES:
1. MEASURED AT THE E
  2. MATERIAL: GLASSRFR
  3. THE 'LF' PRODUCT M
  4. OTHER COUNTRY RE
  5. PARTS WITH AND W
  6. ARE IDENTICAL IN
  7. THE PART NUMBER (
  8. OF ALL RoHS COMP

ABRIDGED  
CAT No MARKED

THIS IS OUR EXCLUSIVE PROPERTY. IT IS NOT TO BE COPIED, REPRODUCED OR DISCLOSED TO THIRD PARTY, AND USED FOR MANUFACTURE WITHOUT OUR WRITTEN CONSENT, AND HAS TO BE RETURNED TO US IN CASE OF NO USAGE

DIT IS ONZE EIGENSCHAP. IT IS NIET TO BE COPIERD, REPRODUKT, OVERNEMING EN AN DEREN, NIET VOOR FABRICATIE GEMAKT WORDEN, ZONDER ONZE SCHRIFTELIJKE TOESTEMMING. BIJ NIET GEBRUIK IS TERUGGEGANGEN VERPLICHT.

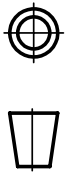

1DEC ± 0, 2	APPR.	D
2DEC ± 0, 1	DRAFT	1997
ANGLES ± 1°	CHECKED	
WE RESERVE THE RIGHT TO CHANGE OUR REQUIREMENTS WITHOUT PRIOR NOTICE.	PROD. MGR	
ALL DIMENSIONS IN MM	PR. ENG. MGR.	
	PR. MGT. MGR.	REFER



PDM: Rev-E-3

## Looking for pricing, stock, or lifecycle information?

Click below to explore more details on WIN SOURCE:

-  [View HM2H88P115LF on WIN SOURCE](#)
-  [Amphenol FCI Information](#)

## Optimize Your Supply Chain with WIN SOURCE Solutions

-  Global Sourcing Solution
-  Obsolete Management
-  Cost Control Management
-  Shortage Management
-  Alternative Solution
-  Excess Inventory Management