



**THE DATASHEET OF
IPAW60R190CEXKSA1**



MOSFET

600V CoolMOS™ CE Power Transistor

CoolMOS™ is a revolutionary technology for high voltage power MOSFETs, designed according to the superjunction (SJ) principle and pioneered by Infineon Technologies. CoolMOS™ CE is a price-performance optimized platform enabling to target cost sensitive applications in Consumer and Lighting markets by still meeting highest efficiency standards. The new series provides all benefits of a fast switching Superjunction MOSFET while not sacrificing ease of use and offering the best cost down performance ratio available on the market.

PG - TO220 FullPAK WideCreepage



Features

- Extremely low losses due to very low FOM $R_{DS(on)} \cdot Q_g$ and Eoss
- Very high commutation ruggedness
- Easy to use/drive
- Pb-free plating, Halogen free mold compound
- Qualified for standard grade applications
- Wide distance of 4.25mm between the leads

Applications

PFC stages, hard switching PWM stages and resonant switching stages for e.g. PC Silverbox, Adapter, LCD & PDP TV and indoor lighting.

Please note: For MOSFET paralleling the use of ferrite beads on the gate or separate totem poles is generally recommended.

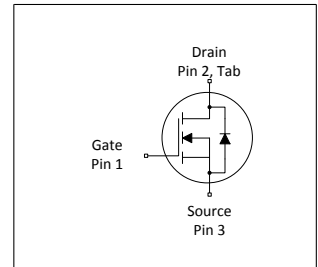

Table 1 Key Performance Parameters

Parameter	Value	Unit
$V_{DS} @ T_{j,max}$	650	V
$R_{DS(on),max}$	190	mΩ
I_D	26.7	A
$Q_{g,typ}$	63	nC
$I_{D,pulse}$	59	A
$E_{oss@400V}$	5.2	μJ

Type / Ordering Code	Package	Marking	Related Links
IPAW60R190CE	PG - TO220 FullPAK WideCreepage	60S190CE	see Appendix A

Table of Contents

Description	1
Maximum ratings	3
Thermal characteristics	4
Electrical characteristics	5
Electrical characteristics diagrams	7
Test Circuits	11
Package Outlines	12
Appendix A	13
Revision History	14
Trademarks	14
Disclaimer	14

1 Maximum ratings

at $T_j = 25^\circ\text{C}$, unless otherwise specified

Table 2 Maximum ratings

Parameter	Symbol	Values			Unit	Note / Test Condition
		Min.	Typ.	Max.		
Continuous drain current ¹⁾	I_D	-	-	26.7 16.9	A	$T_C=25^\circ\text{C}$ $T_C=100^\circ\text{C}$
Pulsed drain current ²⁾	$I_{D,pulse}$	-	-	59	A	$T_C=25^\circ\text{C}$
Avalanche energy, single pulse	E_{AS}	-	-	418	mJ	$I_D=3.4\text{A}$; $V_{DD}=50\text{V}$; see table 10
Avalanche energy, repetitive	E_{AR}	-	-	0.63	mJ	$I_D=3.4\text{A}$; $V_{DD}=50\text{V}$; see table 10
Avalanche current, repetitive	I_{AR}	-	-	3.4	A	-
MOSFET dv/dt ruggedness	dv/dt	-	-	50	V/ns	$V_{DS}=0\dots480\text{V}$
Gate source voltage (static)	V_{GS}	-20	-	20	V	static;
Gate source voltage (dynamic)	V_{GS}	-30	-	30	V	AC ($f>1\text{ Hz}$)
Power dissipation (Full PAK)	P_{tot}	-	-	34	W	$T_C=25^\circ\text{C}$
Storage temperature	T_{stg}	-40	-	150	$^\circ\text{C}$	-
Operating junction temperature	T_j	-40	-	150	$^\circ\text{C}$	-
Mounting torque	-	-	-	50	Ncm	M2.5 screws
Continuous diode forward current	I_S	-	-	18.9	A	$T_C=25^\circ\text{C}$
Diode pulse current ²⁾	$I_{S,pulse}$	-	-	59	A	$T_C=25^\circ\text{C}$
Reverse diode dv/dt ³⁾	dv/dt	-	-	15	V/ns	$V_{DS}=0\dots400\text{V}$, $I_{SD}\leq I_S$, $T_j=25^\circ\text{C}$ see table 8
Maximum diode commutation speed	di/dt	-	-	500	A/ μs	$V_{DS}=0\dots400\text{V}$, $I_{SD}\leq I_S$, $T_j=25^\circ\text{C}$ see table 8
Power dissipation (Non FullPAK) TO-220	P_{tot}	-	-	176	W	-
Insulation withstand voltage for TO-220FP	V_{ISO}	-	-	2500	V	V_{rms} , $T_C=25^\circ\text{C}$, $t=1\text{min}$

¹⁾ Limited by $T_{j,max}$. Maximum duty cycle $D=0.50$, TO-220 equivalent

²⁾ Pulse width t_p limited by $T_{j,max}$

³⁾ Identical low side and high side switch with identical R_G

2 Thermal characteristics

Table 3 Thermal characteristics (Full PAK)

Parameter	Symbol	Values			Unit	Note / Test Condition
		Min.	Typ.	Max.		
Thermal resistance, junction - case	R_{thJC}	-	-	3.7	°C/W	-
Thermal resistance, junction - ambient	R_{thJA}	-	-	80	°C/W	leaded
Soldering temperature, wavesoldering only allowed at leads	T_{sold}	-	-	260	°C	1.6mm (0.063 in.) from case for 10s

3 Electrical characteristics

at $T_j=25^\circ\text{C}$, unless otherwise specified

Table 4 Static characteristics

Parameter	Symbol	Values			Unit	Note / Test Condition
		Min.	Typ.	Max.		
Drain-source breakdown voltage	$V_{(BR)DSS}$	600	-	-	V	$V_{GS}=0\text{V}$, $I_D=0.25\text{mA}$
Gate threshold voltage	$V_{(GS)th}$	2.5	3.0	3.5	V	$V_{DS}=V_{GS}$, $I_D=0.63\text{mA}$
Zero gate voltage drain current	I_{DSS}	-	-	1	μA	$V_{DS}=600$, $V_{GS}=0\text{V}$, $T_j=25^\circ\text{C}$ $V_{DS}=600$, $V_{GS}=0\text{V}$, $T_j=150^\circ\text{C}$
Gate-source leakage current	I_{GSS}	-	-	100	nA	$V_{GS}=20\text{V}$, $V_{DS}=0\text{V}$
Drain-source on-state resistance	$R_{DS(on)}$	-	0.17 0.44	0.19	Ω	$V_{GS}=10\text{V}$, $I_D=9.5\text{A}$, $T_j=25^\circ\text{C}$ $V_{GS}=10\text{V}$, $I_D=9.5\text{A}$, $T_j=150^\circ\text{C}$
Gate resistance	R_G	-	6	-	Ω	$f=1\text{MHz}$, open drain

Table 5 Dynamic characteristics

Parameter	Symbol	Values			Unit	Note / Test Condition
		Min.	Typ.	Max.		
Input capacitance	C_{iss}	-	1400	-	pF	$V_{GS}=0\text{V}$, $V_{DS}=100\text{V}$, $f=1\text{MHz}$
Output capacitance	C_{oss}	-	85	-	pF	$V_{GS}=0\text{V}$, $V_{DS}=100\text{V}$, $f=1\text{MHz}$
Effective output capacitance, energy related ¹⁾	$C_{o(er)}$	-	56	-	pF	$V_{GS}=0\text{V}$, $V_{DS}=0\dots480\text{V}$
Effective output capacitance, time related ²⁾	$C_{o(tr)}$	-	266	-	pF	$I_D=\text{constant}$, $V_{GS}=0\text{V}$, $V_{DS}=0\dots480\text{V}$
Turn-on delay time	$t_{d(on)}$	-	12	-	ns	$V_{DD}=400\text{V}$, $V_{GS}=13\text{V}$, $I_D=9.5\text{A}$, $R_G=3.4\Omega$; see table 9
Rise time	t_r	-	10	-	ns	$V_{DD}=400\text{V}$, $V_{GS}=13\text{V}$, $I_D=9.5\text{A}$, $R_G=3.4\Omega$; see table 9
Turn-off delay time	$t_{d(off)}$	-	90	-	ns	$V_{DD}=400\text{V}$, $V_{GS}=13\text{V}$, $I_D=9.5\text{A}$, $R_G=3.4\Omega$; see table 9
Fall time	t_f	-	8	-	ns	$V_{DD}=400\text{V}$, $V_{GS}=13\text{V}$, $I_D=9.5\text{A}$, $R_G=3.4\Omega$; see table 9

Table 6 Gate charge characteristics

Parameter	Symbol	Values			Unit	Note / Test Condition
		Min.	Typ.	Max.		
Gate to source charge	Q_{GS}	-	7.6	-	nC	$V_{DD}=480\text{V}$, $I_D=9.5\text{A}$, $V_{GS}=0$ to 10V
Gate to drain charge	Q_{gd}	-	32	-	nC	$V_{DD}=480\text{V}$, $I_D=9.5\text{A}$, $V_{GS}=0$ to 10V
Gate charge total	Q_g	-	63	-	nC	$V_{DD}=480\text{V}$, $I_D=9.5\text{A}$, $V_{GS}=0$ to 10V
Gate plateau voltage	$V_{plateau}$	-	5.4	-	V	$V_{DD}=480\text{V}$, $I_D=9.5\text{A}$, $V_{GS}=0$ to 10V

¹⁾ $C_{o(er)}$ is a fixed capacitance that gives the same stored energy as C_{oss} while V_{DS} is rising from 0 to 480V

²⁾ $C_{o(tr)}$ is a fixed capacitance that gives the same charging time as C_{oss} while V_{DS} is rising from 0 to 480V

Table 7 Reverse diode characteristics

Parameter	Symbol	Values			Unit	Note / Test Condition
		Min.	Typ.	Max.		
Diode forward voltage	V_{SD}	-	0.9	-	V	$V_{GS}=0V, I_F=9.5A, T_j=25^\circ C$
Reverse recovery time	t_{rr}	-	430	-	ns	$V_R=400V, I_F=9.5A, di_F/dt=100A/\mu s$; see table 8
Reverse recovery charge	Q_{rr}	-	6.9	-	μC	$V_R=400V, I_F=9.5A, di_F/dt=100A/\mu s$; see table 8
Peak reverse recovery current	I_{rrm}	-	30	-	A	$V_R=400V, I_F=9.5A, di_F/dt=100A/\mu s$; see table 8

4 Electrical characteristics diagrams

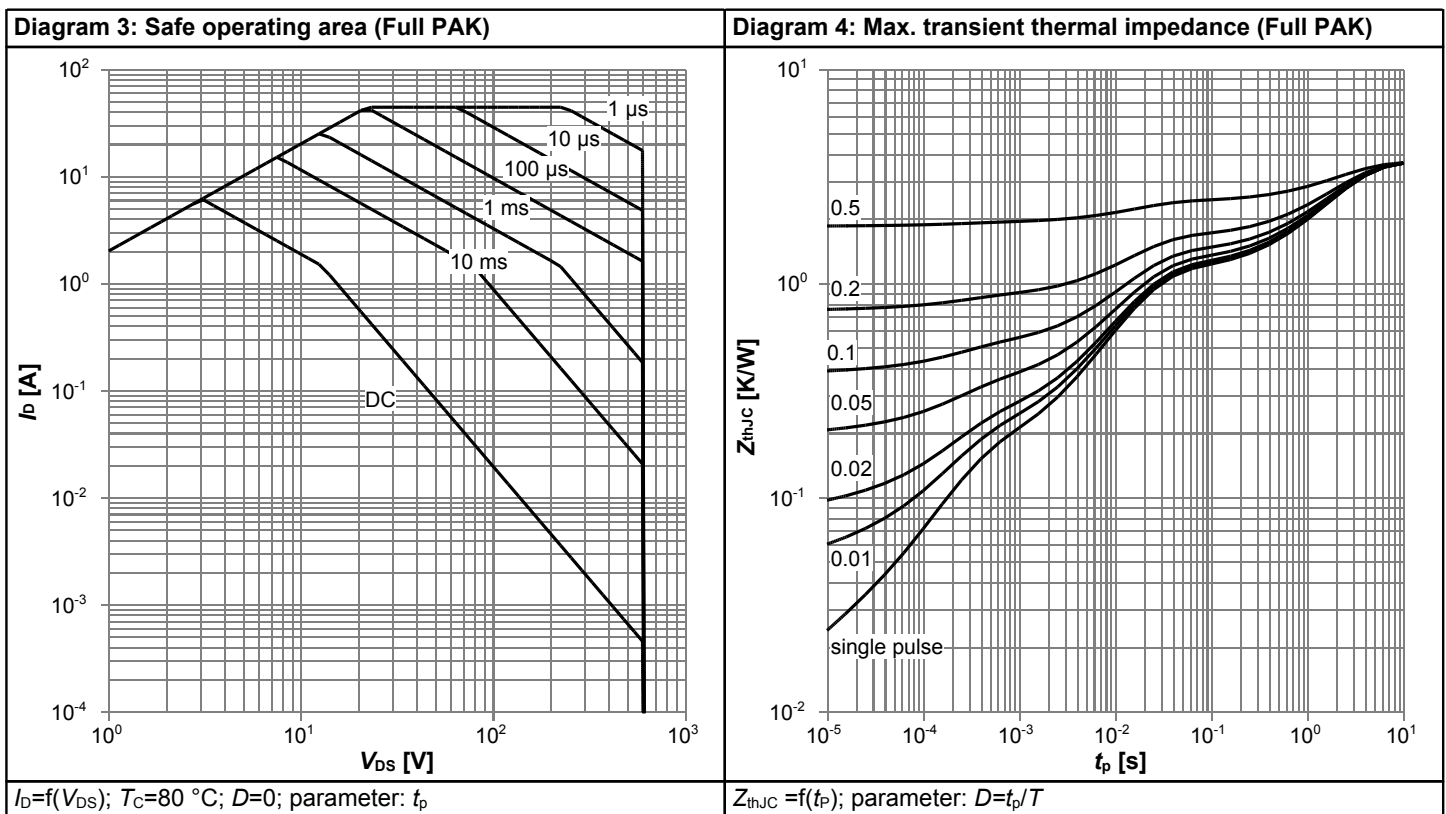
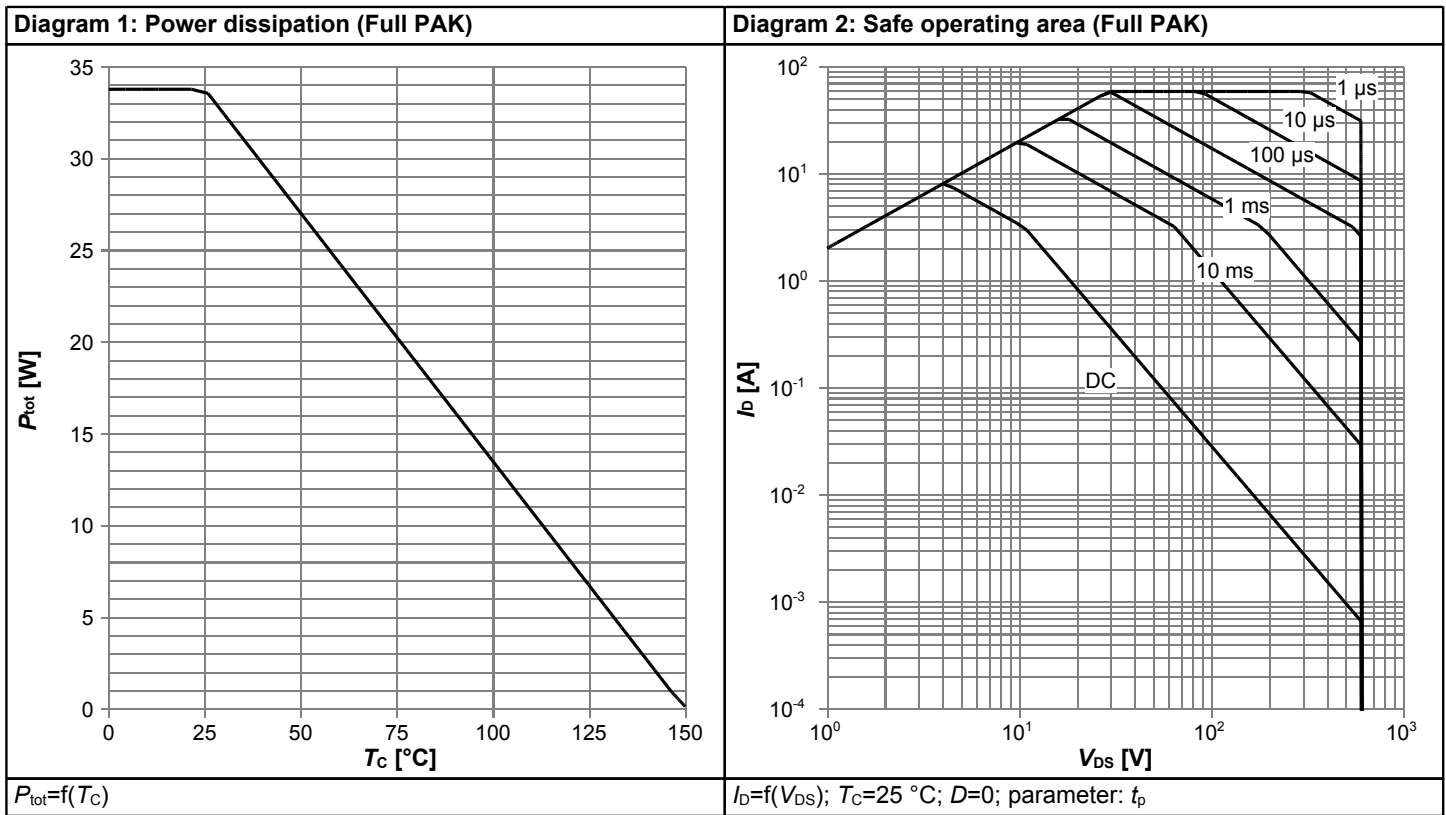

600V CoolMOS™ CE Power Transistor

IPAW60R190CE

Diagram 5: Typ. output characteristics

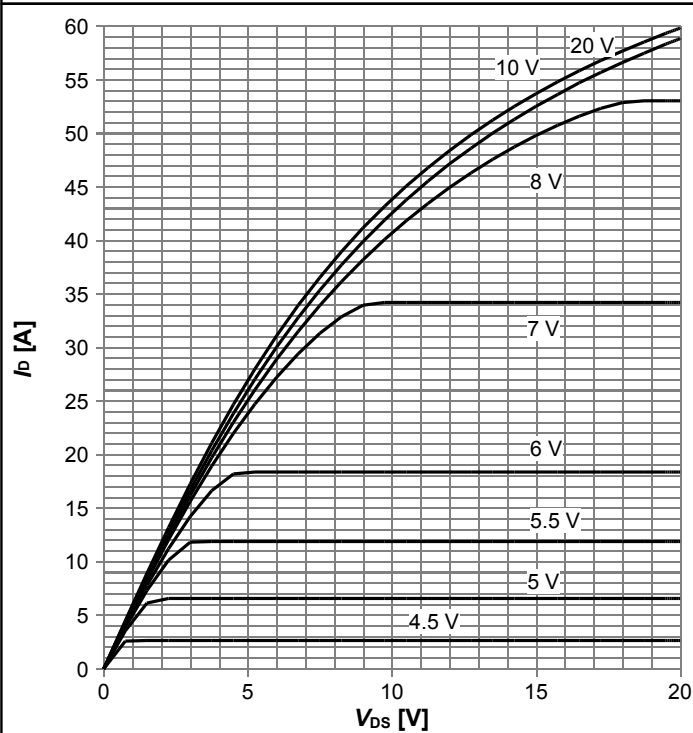

$I_D=f(V_{DS})$; $T_j=25\text{ }^\circ\text{C}$; parameter: V_{GS}

Diagram 6: Typ. output characteristics

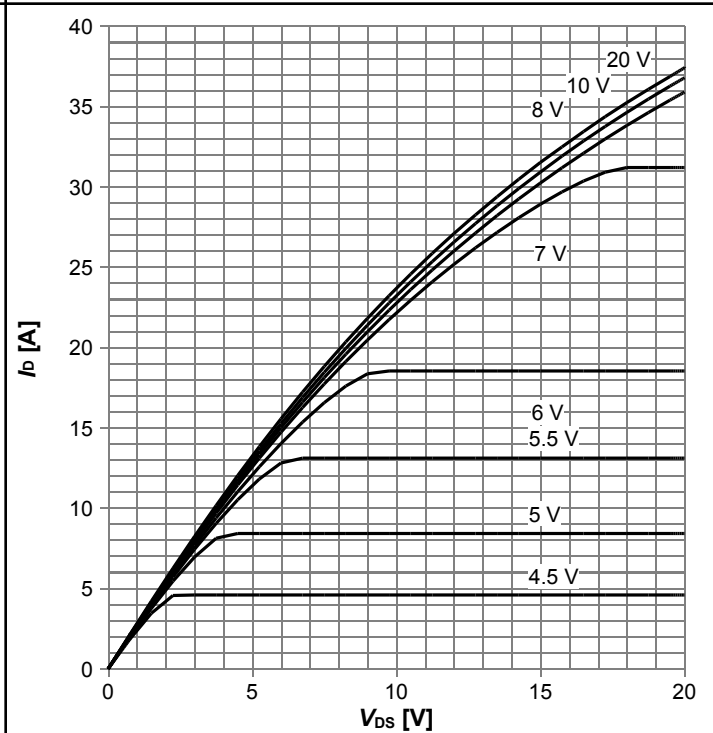

$I_D=f(V_{DS})$; $T_j=125\text{ }^\circ\text{C}$; parameter: V_{GS}

Diagram 7: Typ. drain-source on-state resistance

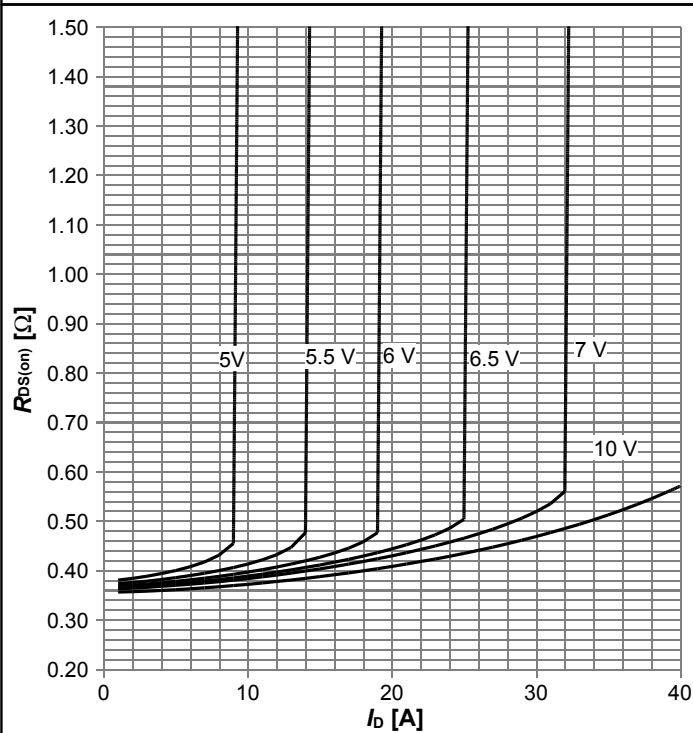

$R_{DS(on)}=f(I_D)$; $T_j=125\text{ }^\circ\text{C}$; parameter: V_{GS}

Diagram 8: Drain-source on-state resistance

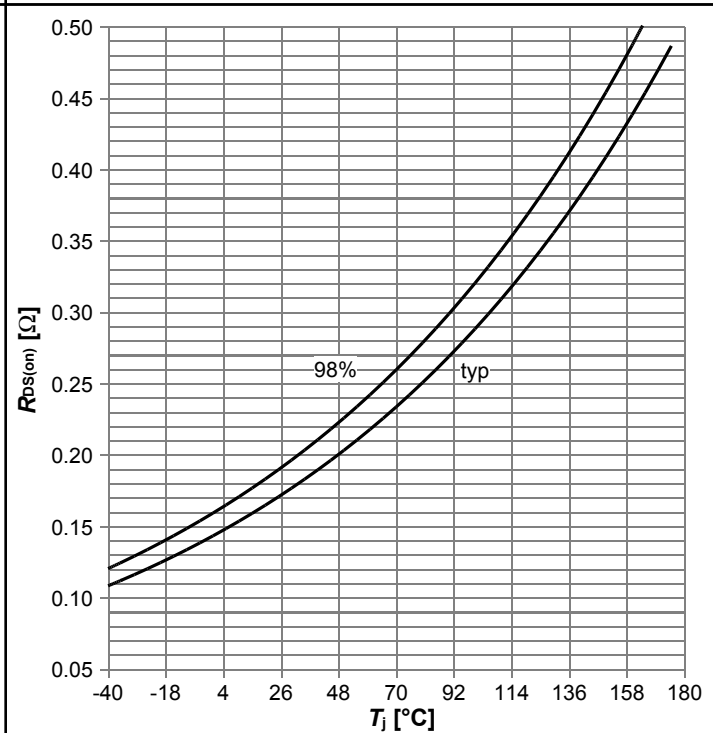

$R_{DS(on)}=f(T_j)$; $I_D=3.4\text{ A}$; $V_{GS}=10\text{ V}$

Diagram 9: Typ. transfer characteristics

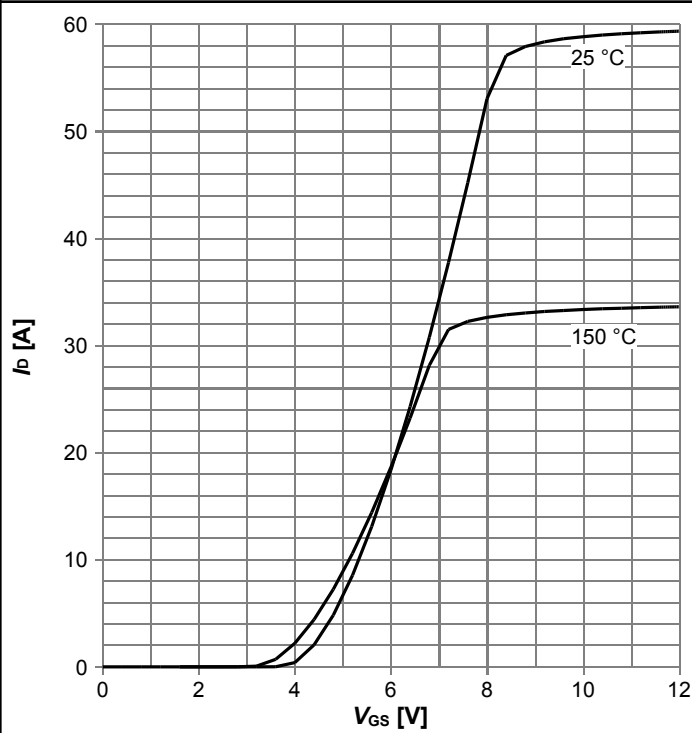

$I_D = f(V_{GS})$; $V_{DS} = 20V$; parameter: T_j

Diagram 10: Typ. gate charge

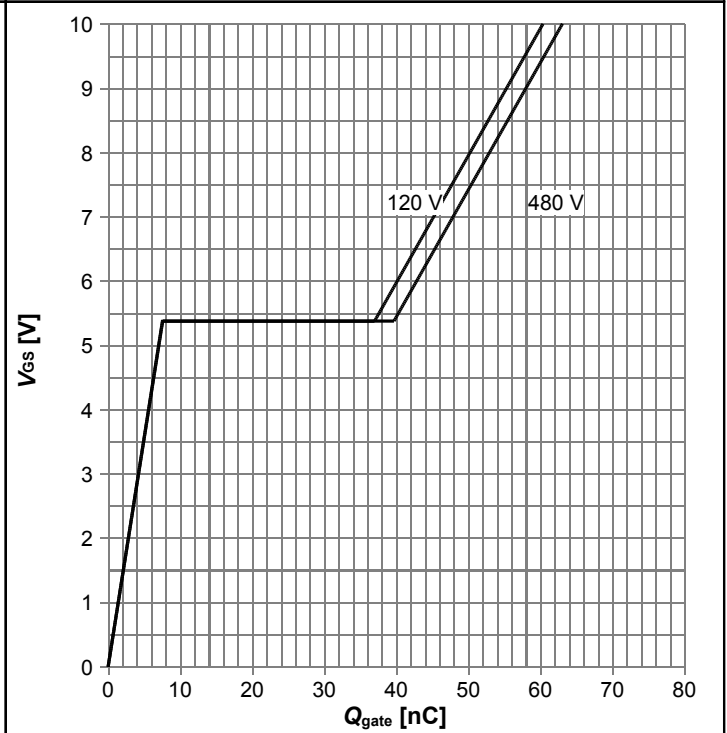

$V_{GS} = f(Q_{gate})$; $I_D = 9.5 A$ pulsed; parameter: V_{DD}

Diagram 11: Forward characteristics of reverse diode

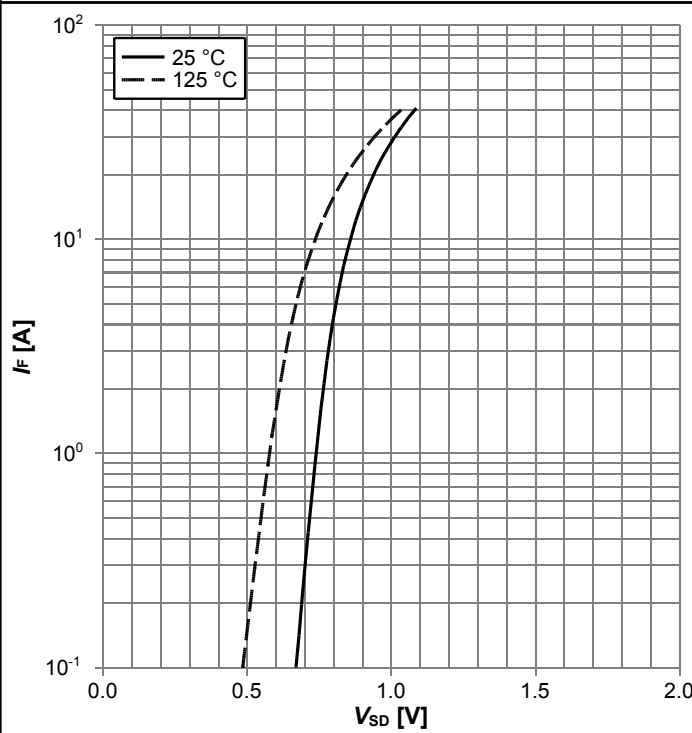

$I_F = f(V_{SD})$; parameter: T_j

Diagram 12: Avalanche energy

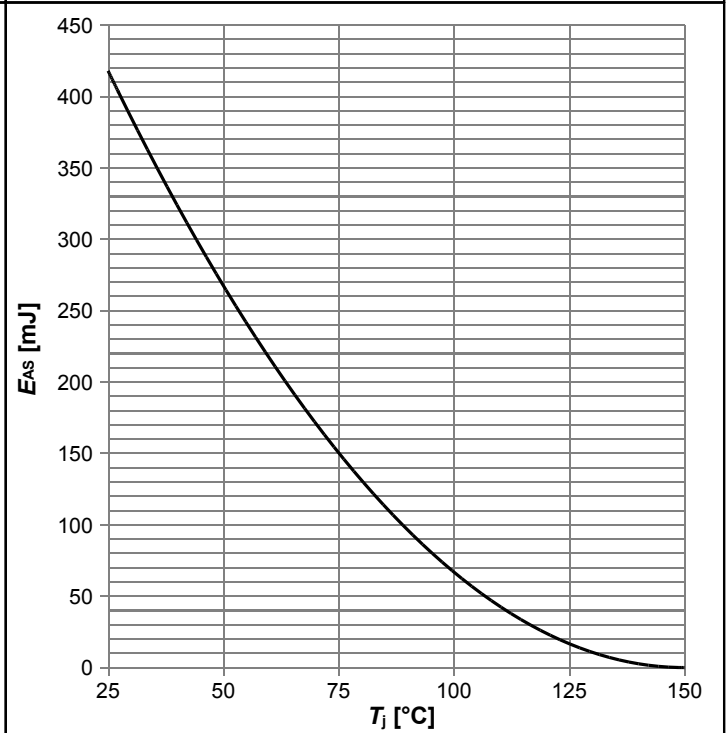

$E_{AS} = f(T_j)$; $I_D = 3.4 A$; $V_{DD} = 50 V$

600V CoolMOS™ CE Power Transistor

IPAW60R190CE

Diagram 13: Drain-source breakdown voltage

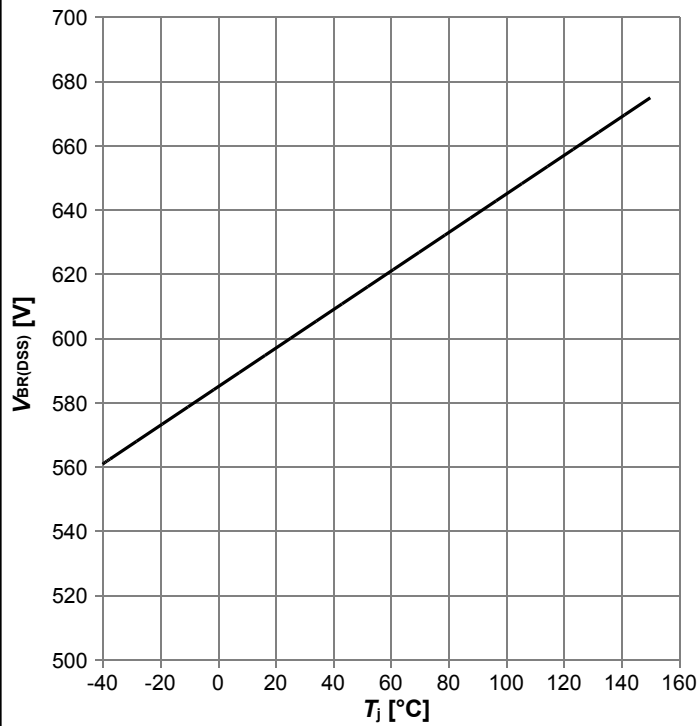

$V_{BR(DSS)} = f(T_j); I_D = 0.25 \text{ mA}$

Diagram 14: Typ. capacitances

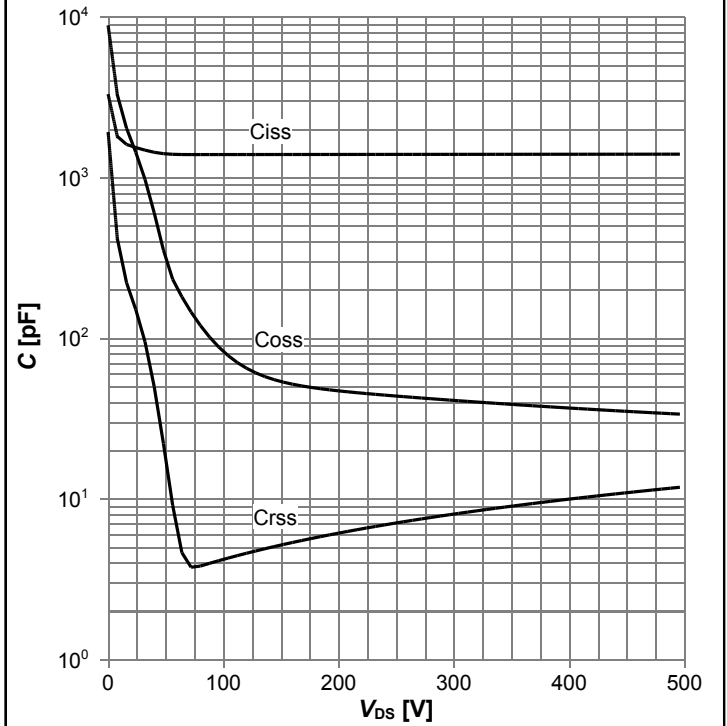

$C = f(V_{DS}); V_{GS} = 0 \text{ V}; f = 1 \text{ MHz}$

Diagram 15: Typ. Coss stored energy

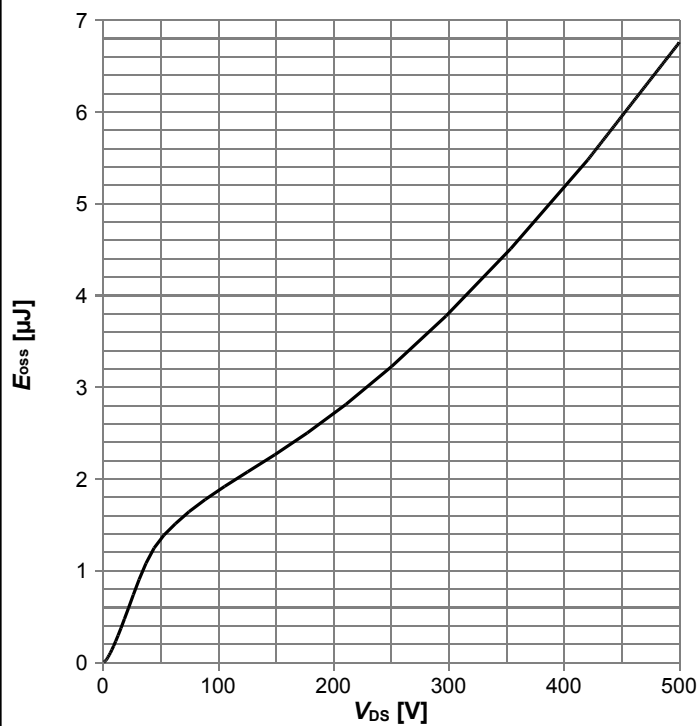

$E_{oss} = f(V_{DS})$

5 Test Circuits

Table 8 Diode characteristics

Test circuit for diode characteristics	Diode recovery waveform
<p>$R_{g1} = R_{g2}$</p>	<p>$t_{tr} = t_F + t_S$ $Q_{tr} = Q_F + Q_S$</p>

Table 9 Switching times

Switching times test circuit for inductive load	Switching times waveform

Table 10 Unclamped inductive load

Unclamped inductive load test circuit	Unclamped inductive waveform

6 Package Outlines

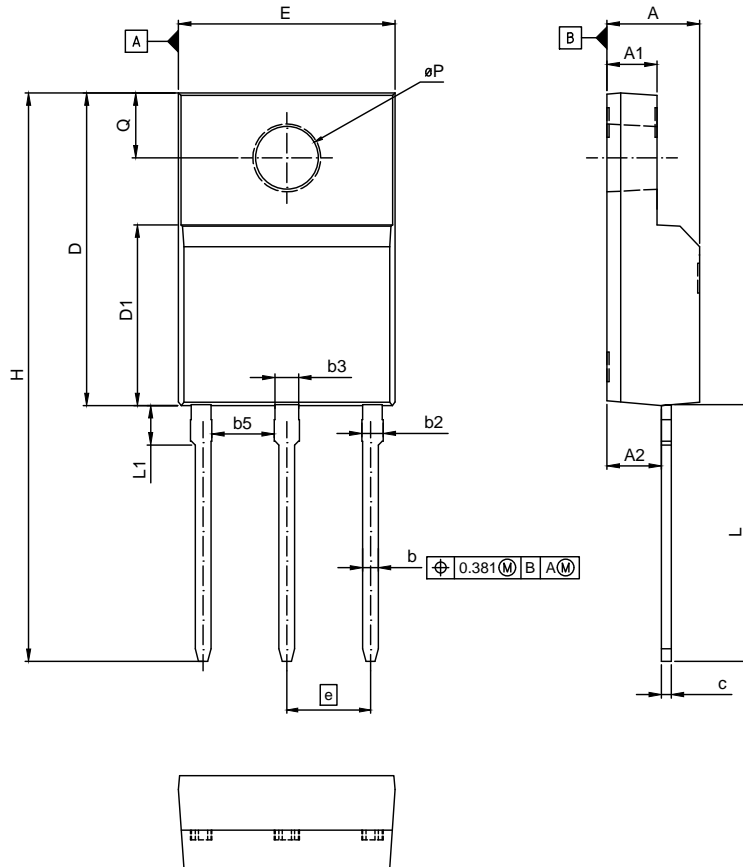

DIMENSIONS DO NOT INCLUDE MOLD FLASH, PROTRUSIONS OR GATE BURRS

DIM	MILLIMETERS		INCHES	
	MIN	MAX	MIN	MAX
A	4.50	4.90	0.177	0.193
A1	2.34	2.74	0.092	0.108
A2	2.65	2.95	0.104	0.116
b	0.75	0.90	0.030	0.035
b2	0.98	1.26	0.039	0.050
b3	1.00	1.40	0.039	0.055
b5	3.00	-	0.118	-
c	0.40	0.60	0.016	0.024
D	15.47	16.27	0.609	0.641
D1	9.17		0.361	
E	10.70	11.30	0.421	0.445
e	4.25 (BSC)		0.167 (BSC)	
N	3		3	
H	28.25	29.45	1.112	1.159
L	12.58	13.38	0.495	0.527
L1	1.70	2.30	0.067	0.091
øP	3.00	3.30	0.118	0.130
Q	3.10	3.50	0.122	0.138

DOCUMENT NO. Z8B00176938
SCALE 0 2 4 mm
EUROPEAN PROJECTION
ISSUE DATE 28-04-2015
REVISION 01

Figure 1 Outline PG - TO220 FullPAK WideCreep, dimensions in mm/inches

7 Appendix A

Table 11 Related Links

- IFX CoolMOS™ CE Webpage: www.infineon.com
- IFX CoolMOS™ CE application note: www.infineon.com
- IFX CoolMOS™ CE simulation model: www.infineon.com
- IFX Design tools: www.infineon.com

Revision History

IPAW60R190CE

Revision: 2016-03-31

Previous Revision

Date	Subjects (major changes since last revision)
2015-10-07	Release of final version
2016-03-31	Modified Id Ratings

Trademarks of Infineon Technologies AG

AURIX™, C166™, CanPAK™, CIPOS™, CoolGaN™, CoolMOS™, CoolSET™, CoolSiC™, CORECONTROL™, CROSSAVE™, DAVE™, DI-POL™, DrBlade™, EasyPIM™, EconoBRIDGE™, EconoDUAL™, EconoPACK™, EconoPIM™, EiceDRIVER™, eupec™, FCOS™, HITFET™, HybridPACK™, Infineon™, ISOFACE™, IsoPACK™, i-Wafer™, MIPAQ™, ModSTACK™, my-d™, NovalithIC™, OmniTune™, OPTIGA™, OptiMOS™, ORIGA™, POWERCODE™, PRIMARION™, PrimePACK™, PrimeSTACK™, PROFET™, PRO-SIL™, RASIC™, REAL3™, ReverSave™, SatRIC™, SIEGET™, SiPMOS™, SmartLEWIS™, SOLID FLASH™, SPOC™, TEMPFET™, thinQ!™, TRENCHSTOP™, TriCore™.

Trademarks updated August 2015

Other Trademarks

All referenced product or service names and trademarks are the property of their respective owners.

We Listen to Your Comments

Any information within this document that you feel is wrong, unclear or missing at all? Your feedback will help us to continuously improve the quality of this document. Please send your proposal (including a reference to this document) to:

erratum@infineon.com

Published by
Infineon Technologies AG
81726 München, Germany
© 2016 Infineon Technologies AG
All Rights Reserved.

Legal Disclaimer

The information given in this document shall in no event be regarded as a guarantee of conditions or characteristics. With respect to any examples or hints given herein, any typical values stated herein and/or any information regarding the application of the device, Infineon Technologies hereby disclaims any and all warranties and liabilities of any kind, including without limitation, warranties of non-infringement of intellectual property rights of any third party.

Information

For further information on technology, delivery terms and conditions and prices please contact your nearest Infineon Technologies Office (www.infineon.com).

Warnings

Due to technical requirements, components may contain dangerous substances. For information on the types in question, please contact the nearest Infineon Technologies Office.

The Infineon Technologies component described in this Data Sheet may be used in life-support devices or systems and/or automotive, aviation and aerospace applications or systems only with the express written approval of Infineon Technologies, if a failure of such components can reasonably be expected to cause the failure of that life-support, automotive, aviation and aerospace device or system or to affect the safety or effectiveness of that device or system. Life support devices or systems are intended to be implanted in the human body or to support and/or maintain and sustain and/or protect human life. If they fail, it is reasonable to assume that the health of the user or other persons may be endangered.

Looking for pricing, stock, or lifecycle information?

Click below to explore more details on WIN SOURCE:

- ⊖ [View IPAW60R190CEXKSA1 on WIN SOURCE](#)
- ⊖ [Infineon Technologies Information](#)

Optimize Your Supply Chain with WIN SOURCE Solutions

- ✓ Global Sourcing Solution
- ✓ Obsolete Management
- ✓ Cost Control Management
- ✓ Shortage Management
- ✓ Alternative Solution
- ✓ Excess Inventory Management