



**THE DATASHEET OF
IPP60R125P6XKSA1**



MOSFET

Metal Oxide Semiconductor Field Effect Transistor

CoolMOS™ P6

600V CoolMOS™ P6 Power Transistor
IPx60R125P6

Data Sheet

Rev. 2.0
Final

1 Description

CoolMOS™ is a revolutionary technology for high voltage power MOSFETs, designed according to the superjunction (SJ) principle and pioneered by Infineon Technologies. CoolMOS™ P6 series combines the experience of the leading SJ MOSFET supplier with high class innovation. The offered devices provide all benefits of a fast switching SJ MOSFET while not sacrificing ease of use. Extremely low switching and conduction losses make switching applications even more efficient, more compact, lighter and cooler.

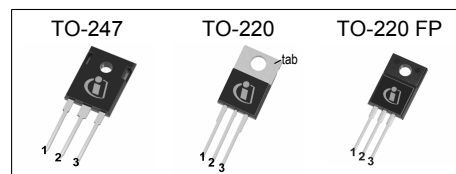

Features

- Increased MOSFET dv/dt ruggedness
- Extremely low losses due to very low FOM $R_{DS(on)} \cdot Q_g$ and E_{oss}
- Very high commutation ruggedness
- Easy to use/drive
- Pb-free plating, Halogen free mold compound
- Qualified for industrial grade applications according to JEDEC (J-STD20 and JESD22)

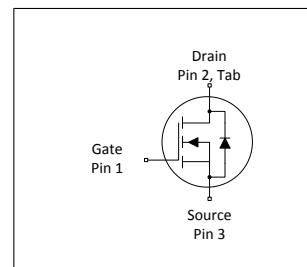

Applications

PFC stages, hard switching PWM stages and resonant switching stages for e.g. PC Silverbox, Adapter, LCD & PDP TV, Lighting, Server, Telecom and UPS.



Please note: For MOSFET paralleling the use of ferrite beads on the gate or separate totem poles is generally recommended.

Table 1 Key Performance Parameters

Parameter	Value	Unit
$V_{DS} @ T_{j,max}$	650	V
$R_{DS(on),max}$	125	mΩ
$Q_{g,typ}$	56	nC
$I_{D,pulse}$	87	A
$E_{oss@400V}$	7.2	μJ
Body diode di/dt	300	A/μs

Type / Ordering Code	Package	Marking	Related Links
IPW60R125P6	PG-TO 247	6R125P6	see Appendix A
IPP60R125P6	PG-TO 220		
IPA60R125P6	PG-TO 220 FullPAK		



Table of Contents

Description	2
Maximum ratings	4
Thermal characteristics	5
Electrical characteristics	6
Electrical characteristics diagrams	8
Test Circuits	13
Package Outlines	14
Appendix A	17
Revision History	18
Disclaimer	18

2 Maximum ratings

at $T_j = 25^\circ\text{C}$, unless otherwise specified

Table 2 Maximum ratings

Parameter	Symbol	Values			Unit	Note / Test Condition
		Min.	Typ.	Max.		
Continuous drain current ¹⁾	I_D	-	-	30.0 19.0	A	$T_C=25^\circ\text{C}$ $T_C=100^\circ\text{C}$
Pulsed drain current ²⁾	$I_{D,pulse}$	-	-	87	A	$T_C=25^\circ\text{C}$
Avalanche energy, single pulse	E_{AS}	-	-	636	mJ	$I_D=5.2\text{A}$; $V_{DD}=50\text{V}$; see table 10
Avalanche energy, repetitive	E_{AR}	-	-	0.96	mJ	$I_D=5.2\text{A}$; $V_{DD}=50\text{V}$; see table 10
Avalanche current, repetitive	I_{AR}	-	-	5.2	A	-
MOSFET dv/dt ruggedness	dv/dt	-	-	100	V/ns	$V_{DS}=0\dots400\text{V}$
Gate source voltage (static)	V_{GS}	-20	-	20	V	static;
Gate source voltage (dynamic)	V_{GS}	-30	-	30	V	AC ($f>1\text{ Hz}$)
Power dissipation (Non FullPAK) TO-220, TO-247	P_{tot}	-	-	219	W	$T_C=25^\circ\text{C}$
Power dissipation (FullPAK) TO-220FP	P_{tot}	-	-	34	W	$T_C=25^\circ\text{C}$
Storage temperature	T_{stg}	-55	-	150	$^\circ\text{C}$	-
Operating junction temperature	T_j	-55	-	150	$^\circ\text{C}$	-
Mounting torque (Non FullPAK) TO-220, TO-247	-	-	-	60	Ncm	M3 and M3.5 screws
Mounting torque (FullPAK) TO-220FP	-	-	-	50	Ncm	M2.5 screws
Continuous diode forward current	I_S	-	-	26.0	A	$T_C=25^\circ\text{C}$
Diode pulse current ²⁾	$I_{S,pulse}$	-	-	87	A	$T_C=25^\circ\text{C}$
Reverse diode dv/dt ³⁾	dv/dt	-	-	15	V/ns	$V_{DS}=0\dots400\text{V}$, $I_{SD}\leq I_S$, $T_j=25^\circ\text{C}$ see table 8
Maximum diode commutation speed	di/dt	-	-	300	A/ μs	$V_{DS}=0\dots400\text{V}$, $I_{SD}\leq I_S$, $T_j=25^\circ\text{C}$ see table 8
Insulation withstand voltage for TO-220FP	V_{ISO}	-	-	2500	V	V_{rms} , $T_C=25^\circ\text{C}$, $t=1\text{min}$

¹⁾ Limited by $T_{j,max}$. Maximum duty cycle $D=0.75$

²⁾ Pulse width t_p limited by $T_{j,max}$

³⁾ Identical low side and high side switch with identical R_G

3 Thermal characteristics

Table 3 Thermal characteristics (Non FullPAK) TO-220, TO-247

Parameter	Symbol	Values			Unit	Note / Test Condition
		Min.	Typ.	Max.		
Thermal resistance, junction - case	R_{thJC}	-	-	0.57	°C/W	-
Thermal resistance, junction - ambient	R_{thJA}	-	-	62	°C/W	leaded
Soldering temperature, wavesoldering only allowed at leads	T_{sold}	-	-	260	°C	1.6mm (0.063 in.) from case for 10s

Table 4 Thermal characteristics (FullPAK) TO-220FP

Parameter	Symbol	Values			Unit	Note / Test Condition
		Min.	Typ.	Max.		
Thermal resistance, junction - case	R_{thJC}	-	-	3.65	°C/W	-
Thermal resistance, junction - ambient	R_{thJA}	-	-	80	°C/W	leaded
Soldering temperature, wavesoldering only allowed at leads	T_{sold}	-	-	260	°C	1.6mm (0.063 in.) from case for 10s

4 Electrical characteristics

at $T_j=25^\circ\text{C}$, unless otherwise specified

Table 5 Static characteristics

Parameter	Symbol	Values			Unit	Note / Test Condition
		Min.	Typ.	Max.		
Drain-source breakdown voltage	$V_{(BR)DSS}$	600	-	-	V	$V_{GS}=0\text{V}$, $I_D=1\text{mA}$
Gate threshold voltage	$V_{(GS)th}$	3.5	4.0	4.5	V	$V_{DS}=V_{GS}$, $I_D=0.96\text{mA}$
Zero gate voltage drain current	I_{DSS}	-	-	2	μA	$V_{DS}=600$, $V_{GS}=0\text{V}$, $T_j=25^\circ\text{C}$ $V_{DS}=600$, $V_{GS}=0\text{V}$, $T_j=150^\circ\text{C}$
Gate-source leakage current	I_{GSS}	-	-	100	nA	$V_{GS}=20\text{V}$, $V_{DS}=0\text{V}$
Drain-source on-state resistance	$R_{DS(on)}$	-	0.113 0.293	0.125	Ω	$V_{GS}=10\text{V}$, $I_D=11.6\text{A}$, $T_j=25^\circ\text{C}$ $V_{GS}=10\text{V}$, $I_D=11.6\text{A}$, $T_j=150^\circ\text{C}$
Gate resistance	R_G	-	1.7	-	Ω	$f=1\text{MHz}$, open drain

Table 6 Dynamic characteristics

Parameter	Symbol	Values			Unit	Note / Test Condition
		Min.	Typ.	Max.		
Input capacitance	C_{iss}	-	2660	-	pF	$V_{GS}=0\text{V}$, $V_{DS}=100\text{V}$, $f=1\text{MHz}$
Output capacitance	C_{oss}	-	110	-	pF	$V_{GS}=0\text{V}$, $V_{DS}=100\text{V}$, $f=1\text{MHz}$
Effective output capacitance, energy related ¹⁾	$C_{o(er)}$	-	90	-	pF	$V_{GS}=0\text{V}$, $V_{DS}=0\dots400\text{V}$
Effective output capacitance, time related ²⁾	$C_{o(tr)}$	-	398	-	pF	$I_D=\text{constant}$, $V_{GS}=0\text{V}$, $V_{DS}=0\dots400\text{V}$
Turn-on delay time	$t_{d(on)}$	-	14	-	ns	$V_{DD}=400\text{V}$, $V_{GS}=13\text{V}$, $I_D=14.5\text{A}$, $R_G=1.7\Omega$; see table 9
Rise time	t_r	-	9	-	ns	$V_{DD}=400\text{V}$, $V_{GS}=13\text{V}$, $I_D=14.5\text{A}$, $R_G=1.7\Omega$; see table 9
Turn-off delay time	$t_{d(off)}$	-	44	-	ns	$V_{DD}=400\text{V}$, $V_{GS}=13\text{V}$, $I_D=14.5\text{A}$, $R_G=1.7\Omega$; see table 9
Fall time	t_f	-	5	-	ns	$V_{DD}=400\text{V}$, $V_{GS}=13\text{V}$, $I_D=14.5\text{A}$, $R_G=1.7\Omega$; see table 9

Table 7 Gate charge characteristics

Parameter	Symbol	Values			Unit	Note / Test Condition
		Min.	Typ.	Max.		
Gate to source charge	Q_{gs}	-	16	-	nC	$V_{DD}=400\text{V}$, $I_D=14.5\text{A}$, $V_{GS}=0$ to 10V
Gate to drain charge	Q_{gd}	-	20	-	nC	$V_{DD}=400\text{V}$, $I_D=14.5\text{A}$, $V_{GS}=0$ to 10V
Gate charge total	Q_g	-	56	-	nC	$V_{DD}=400\text{V}$, $I_D=14.5\text{A}$, $V_{GS}=0$ to 10V
Gate plateau voltage	$V_{plateau}$	-	6.1	-	V	$V_{DD}=400\text{V}$, $I_D=14.5\text{A}$, $V_{GS}=0$ to 10V

¹⁾ $C_{o(er)}$ is a fixed capacitance that gives the same stored energy as C_{oss} while V_{DS} is rising from 0 to 400V

²⁾ $C_{o(tr)}$ is a fixed capacitance that gives the same charging time as C_{oss} while V_{DS} is rising from 0 to 400V

Table 8 Reverse diode characteristics

Parameter	Symbol	Values			Unit	Note / Test Condition
		Min.	Typ.	Max.		
Diode forward voltage	V_{SD}	-	0.9	-	V	$V_{GS}=0V, I_F=14.5A, T_j=25^{\circ}C$
Reverse recovery time	t_{rr}	-	385	-	ns	$V_R=400V, I_F=14.5A, di_F/dt=100A/\mu s$; see table 8
Reverse recovery charge	Q_{rr}	-	7	-	μC	$V_R=400V, I_F=14.5A, di_F/dt=100A/\mu s$; see table 8
Peak reverse recovery current	I_{rrm}	-	32	-	A	$V_R=400V, I_F=14.5A, di_F/dt=100A/\mu s$; see table 8

5 Electrical characteristics diagrams

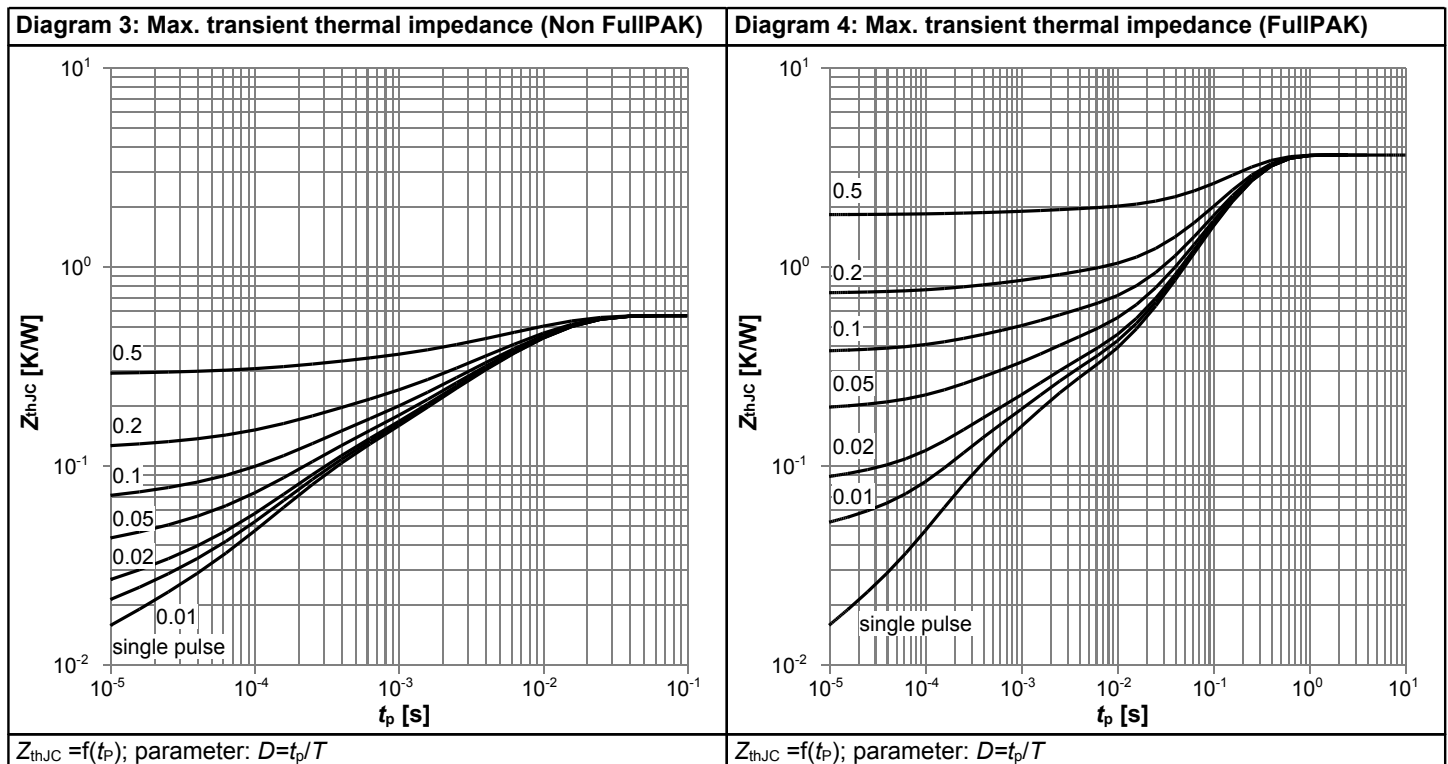
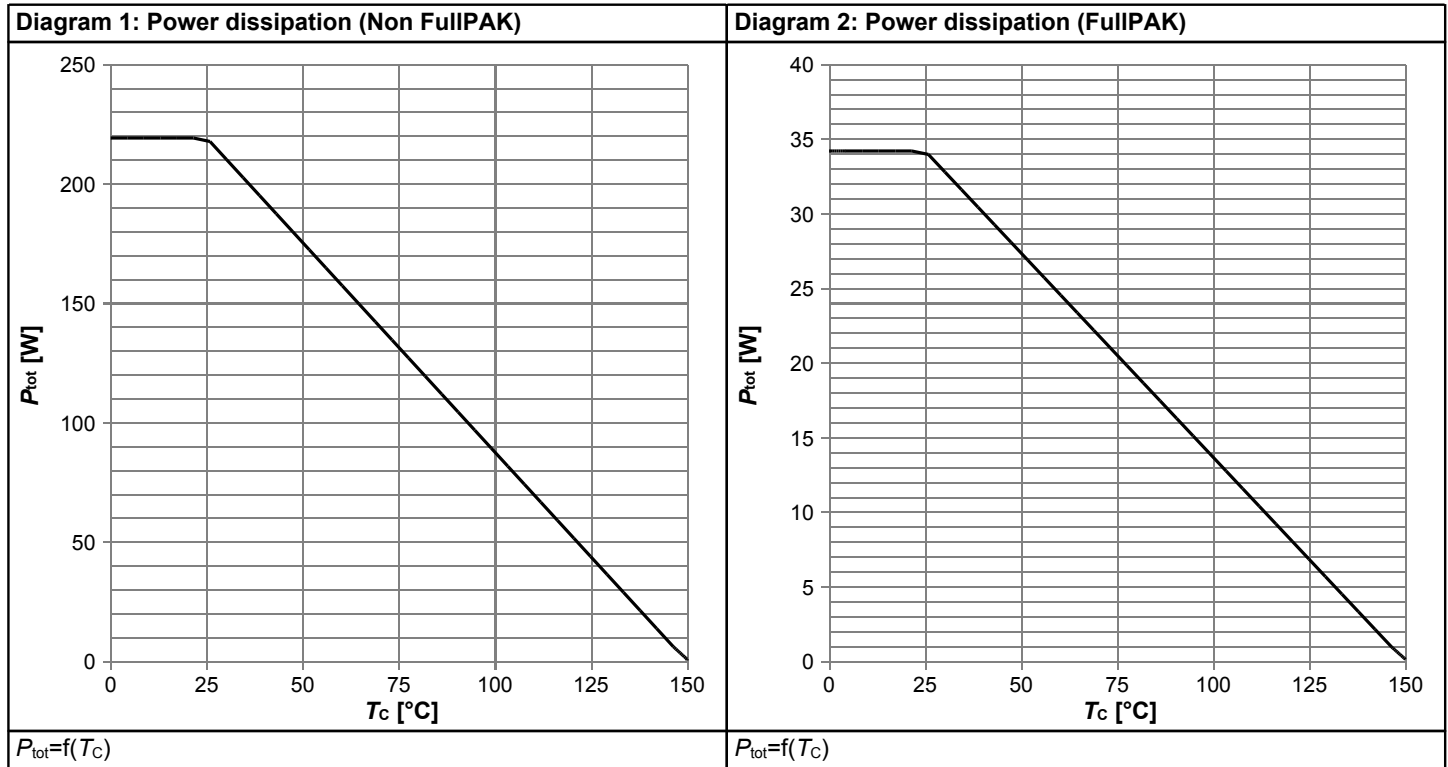
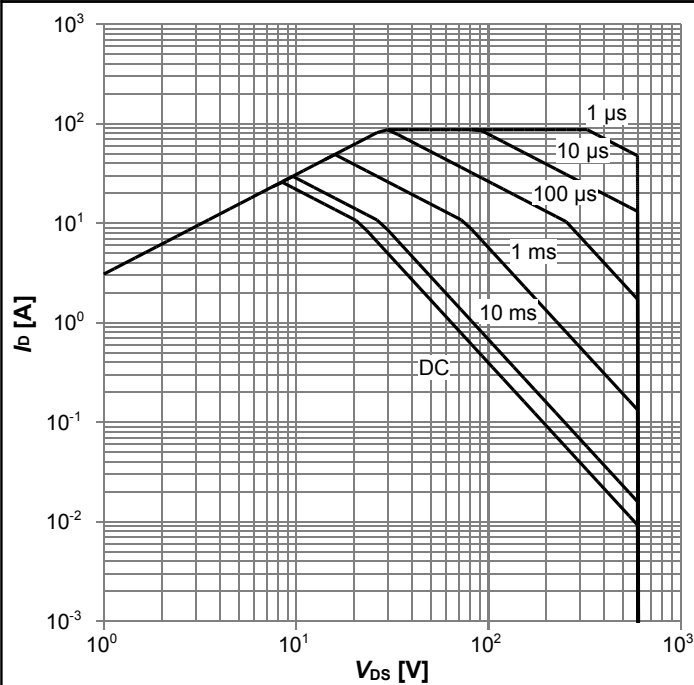
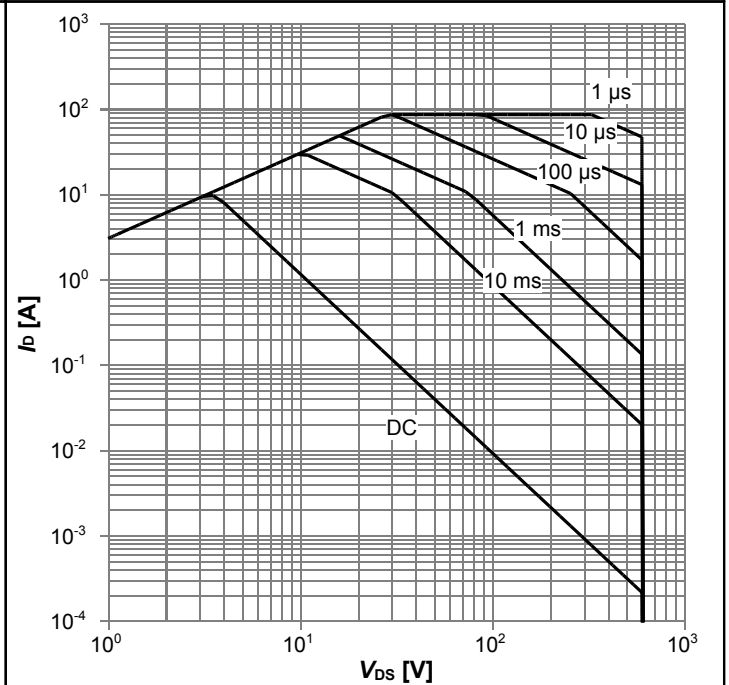

Diagram 5: Safe operating area (Non FullPAK)



$I_b=f(V_{Ds}); T_C=25\text{ °C}; D=0$; parameter: t_p

Diagram 6: Safe operating area (FullPAK)



$I_b=f(V_{Ds}); T_C=25\text{ °C}; D=0$; parameter: t_p

Diagram 7: Safe operating area (Non FullPAK)

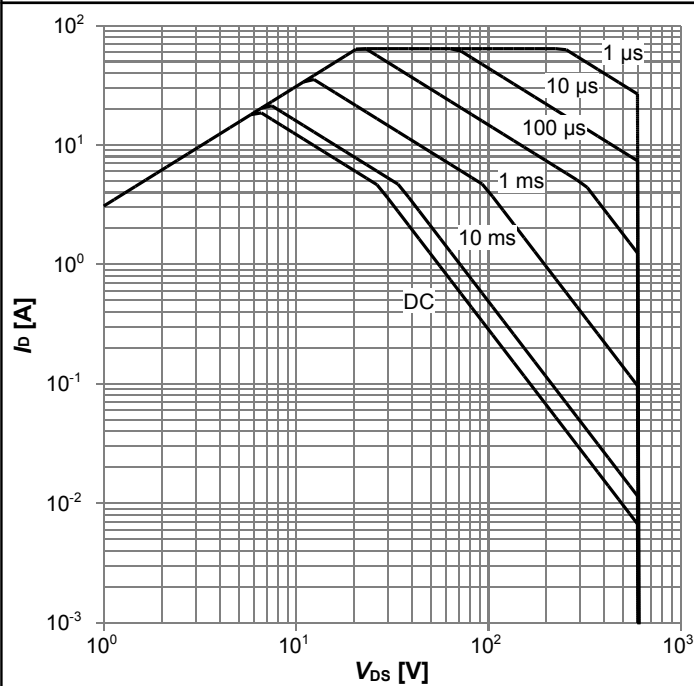

$I_b=f(V_{Ds}); T_C=80\text{ °C}; D=0$; parameter: t_p

Diagram 8: Safe operating area (FullPAK)

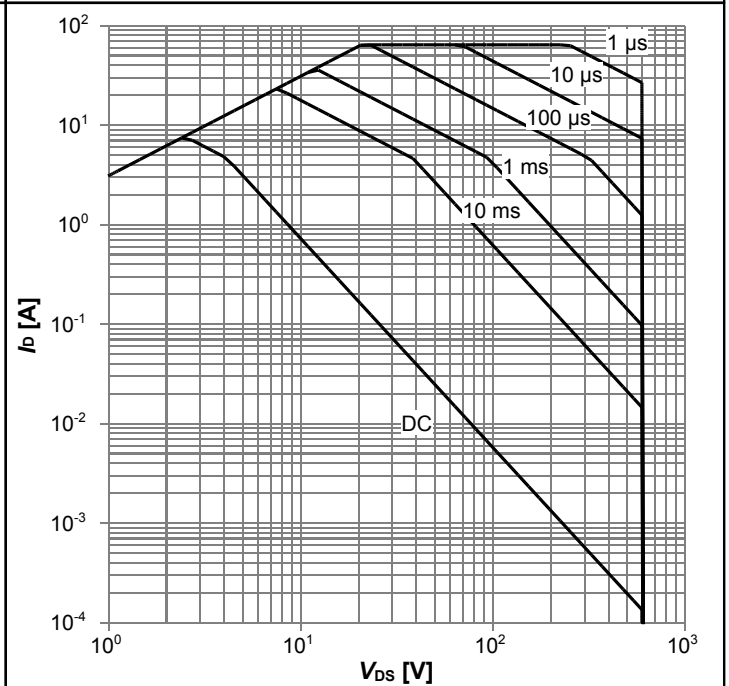

$I_b=f(V_{Ds}); T_C=80\text{ °C}; D=0$; parameter: t_p

Diagram 9: Typ. output characteristics

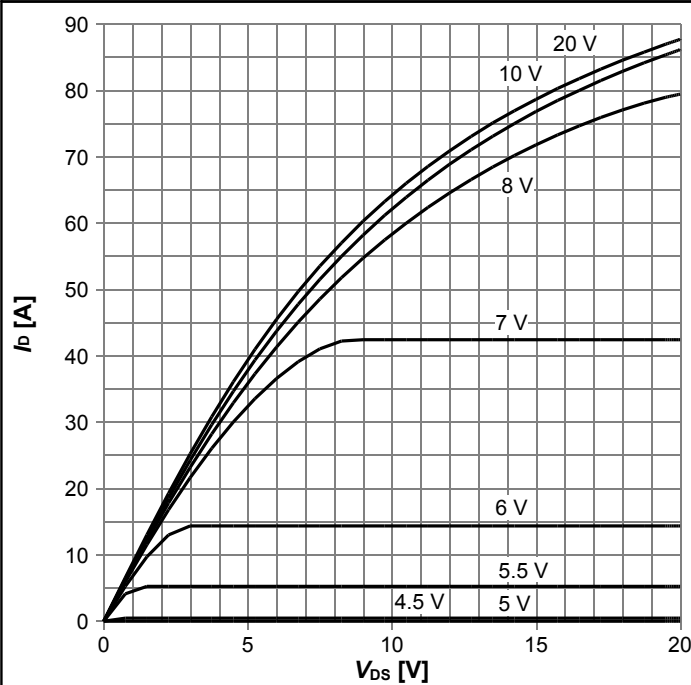

$I_D = f(V_{DS})$; $T_j = 25^\circ\text{C}$; parameter: V_{GS}

Diagram 10: Typ. output characteristics

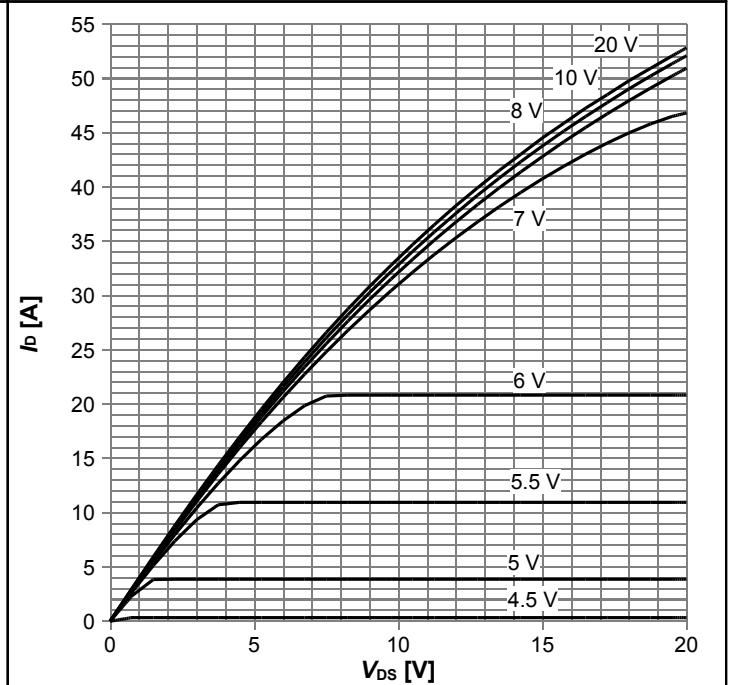

$I_D = f(V_{DS})$; $T_j = 125^\circ\text{C}$; parameter: V_{GS}

Diagram 11: Typ. drain-source on-state resistance

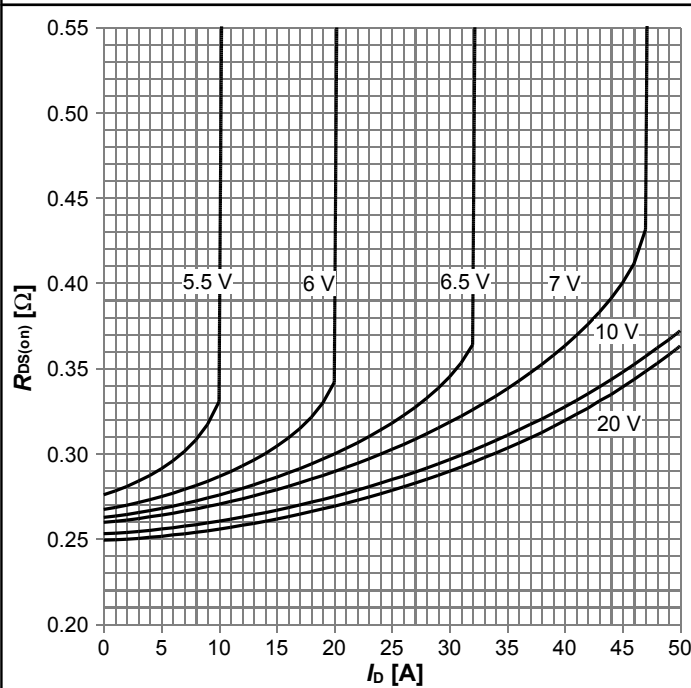

$R_{DS(on)} = f(I_D)$; $T_j = 125^\circ\text{C}$; parameter: V_{GS}

Diagram 12: Drain-source on-state resistance

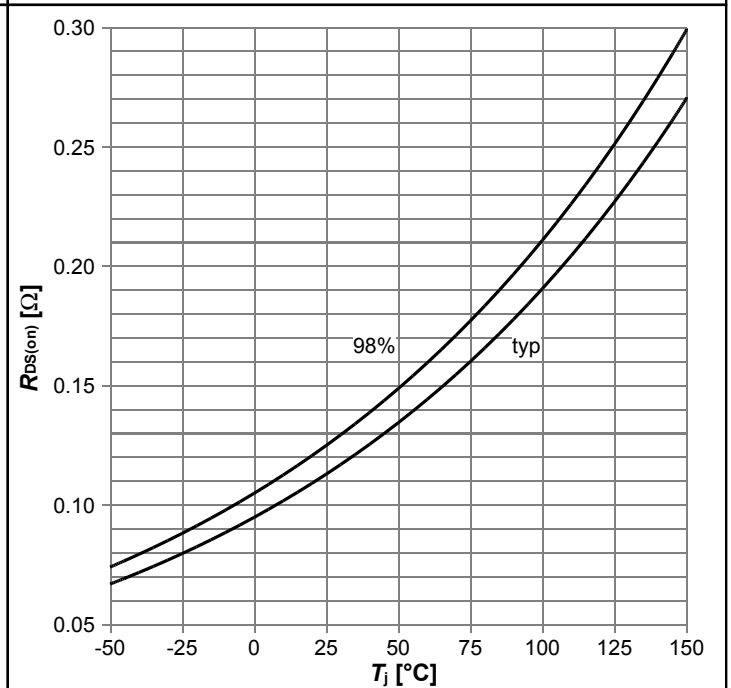

$R_{DS(on)} = f(T_j)$; $I_D = 11.6\text{ A}$; $V_{GS} = 10\text{ V}$

Diagram 13: Typ. transfer characteristics

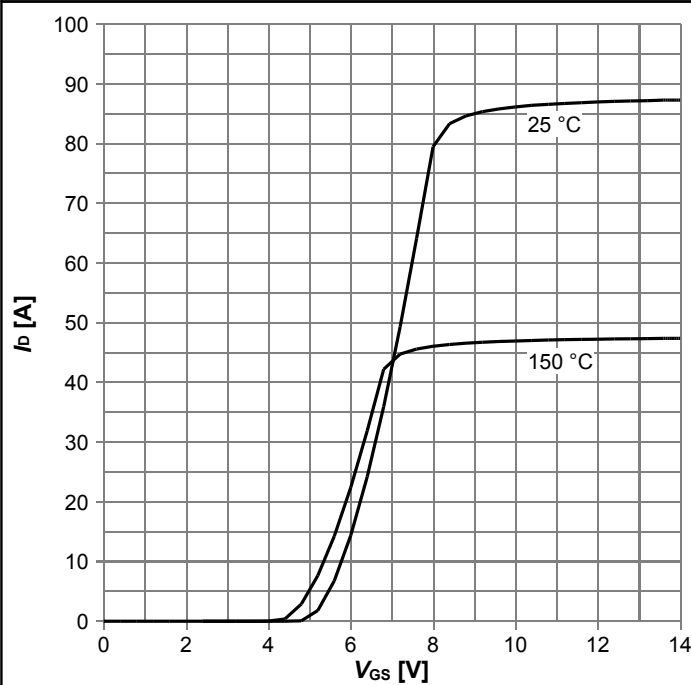

$I_D=f(V_{GS}); V_{DS}=20V; \text{parameter: } T_j$

Diagram 14: Typ. gate charge

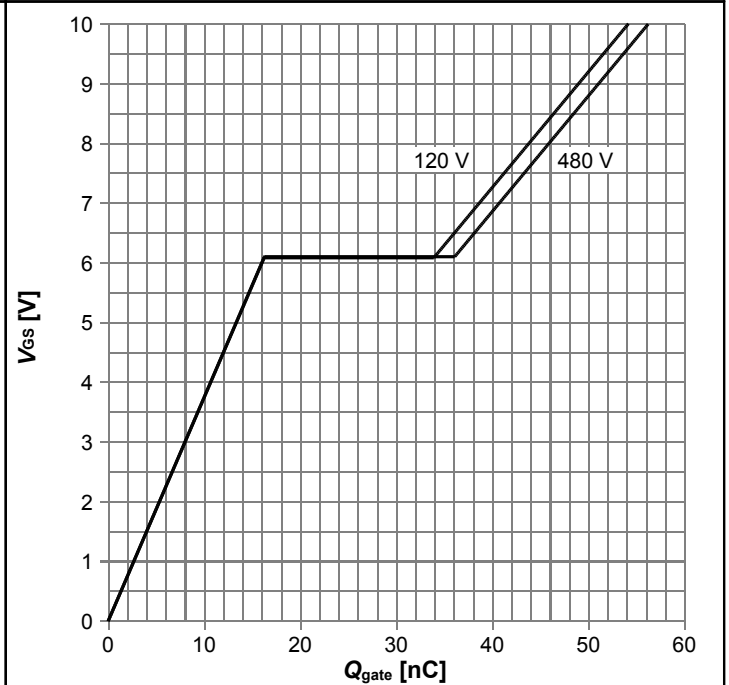

$V_{GS}=f(Q_{gate}); I_D=14.5 \text{ A pulsed}; \text{parameter: } V_{DD}$

Diagram 15: Forward characteristics of reverse diode

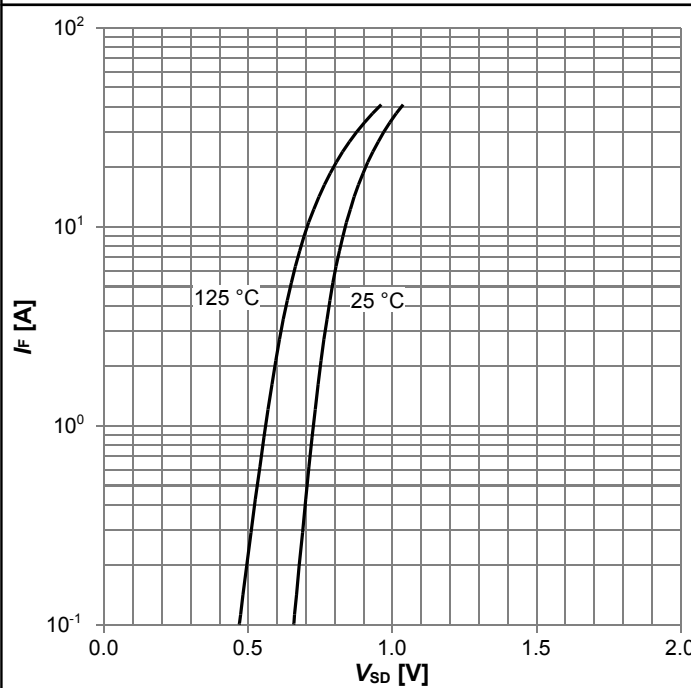

$I_F=f(V_{SD}); \text{parameter: } T_j$

Diagram 16: Avalanche energy

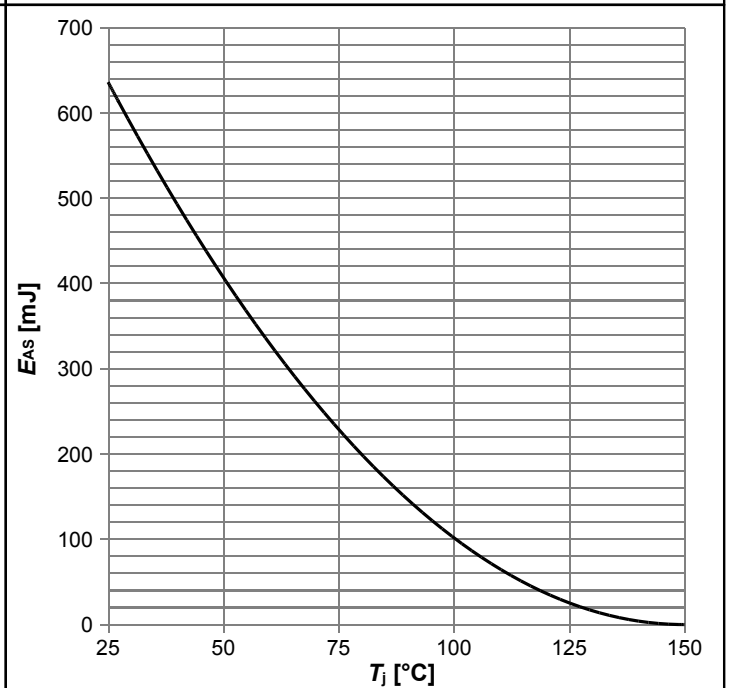

$E_{AS}=f(T_j); I_D=5.2 \text{ A}; V_{DD}=50 \text{ V}$

Diagram 17: Drain-source breakdown voltage

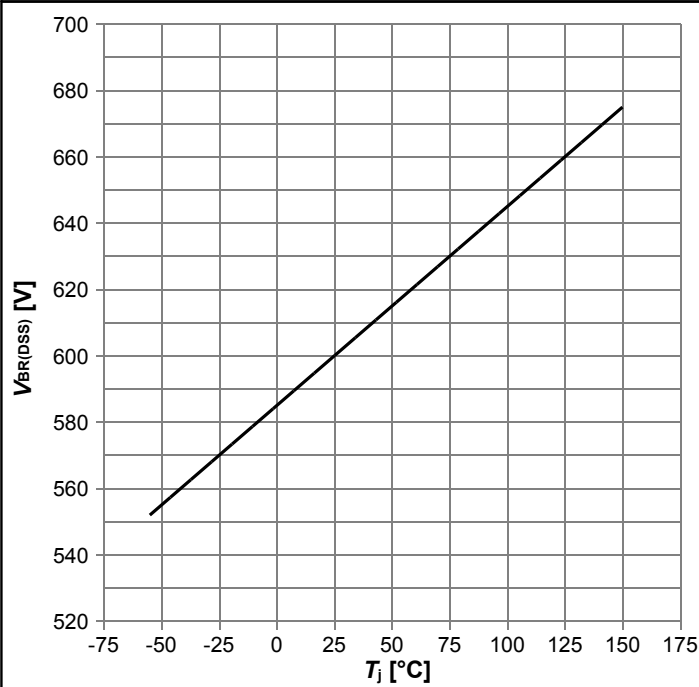

$V_{BR(DSS)}=f(T_j); I_D=1 \text{ mA}$

Diagram 18: Typ. capacitances

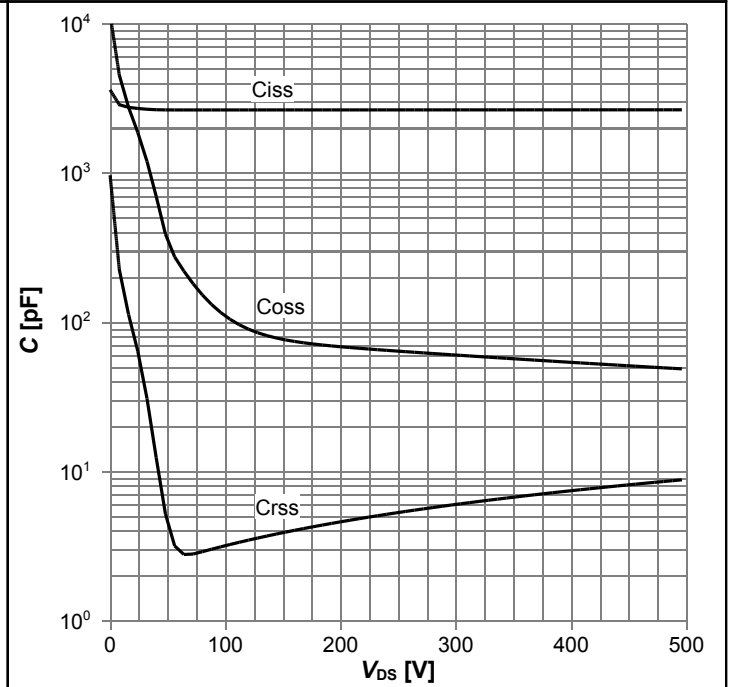

$C=f(V_{DS}); V_{GS}=0 \text{ V}; f=1 \text{ MHz}$

Diagram 19: Typ. Coss stored energy

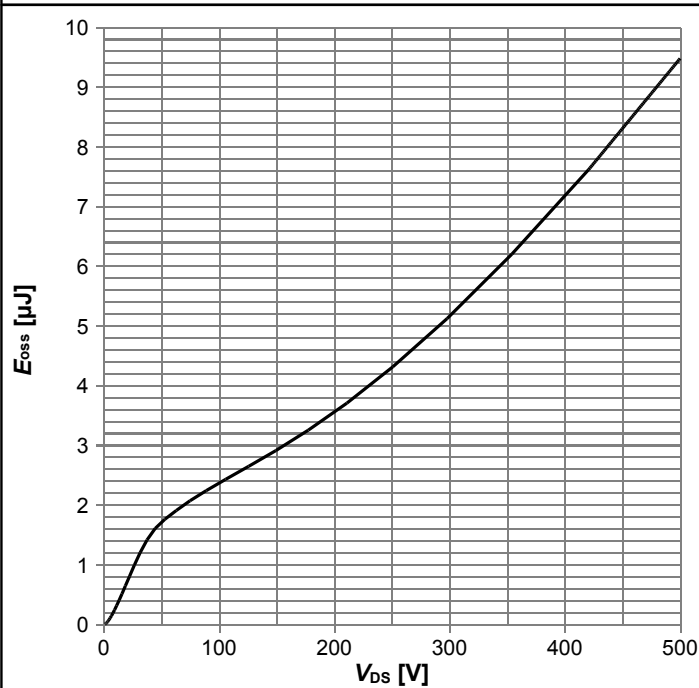

$E_{oss}=f(V_{DS})$

7 Package Outlines

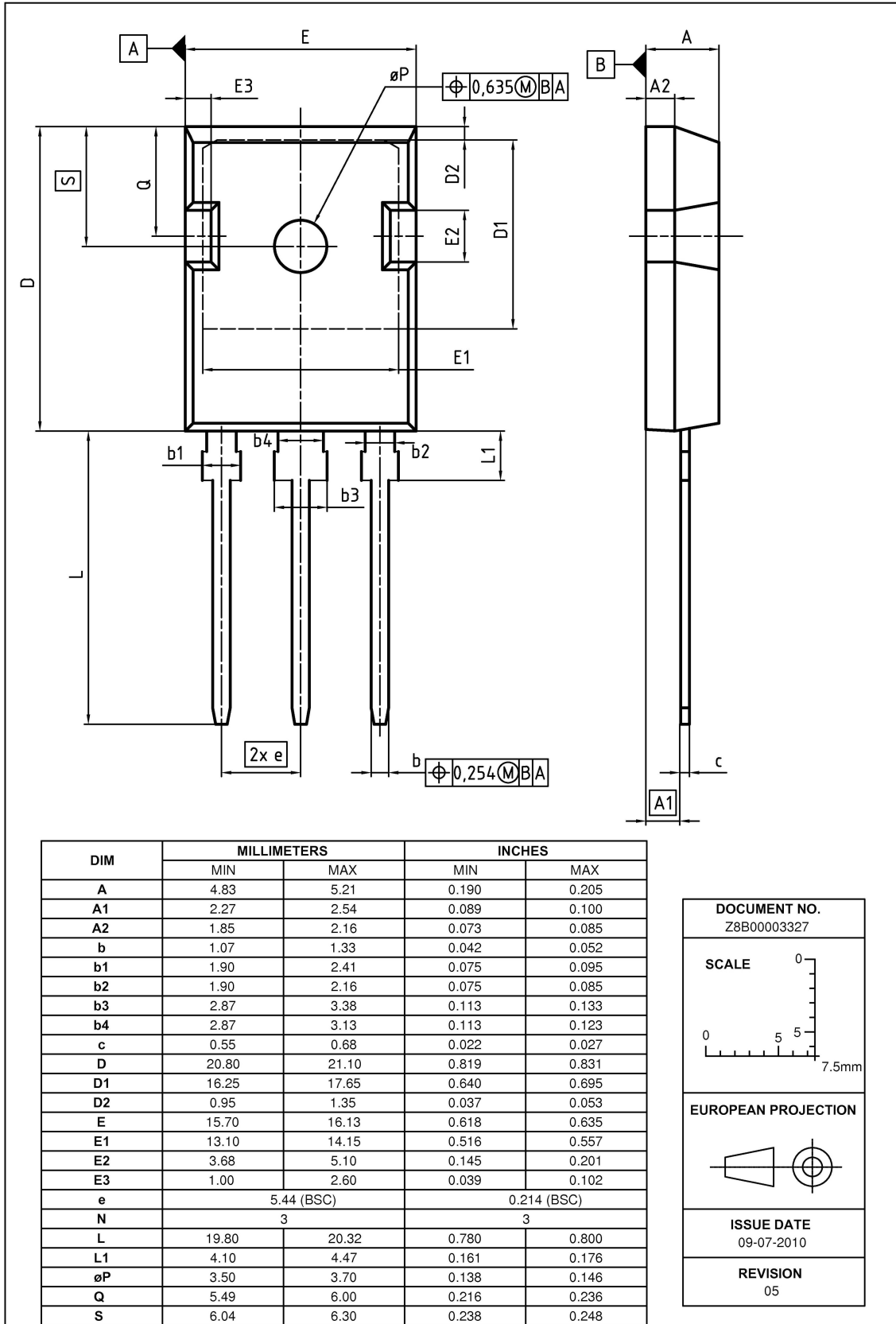

Figure 1 Outline PG-TO 247, dimensions in mm/inches

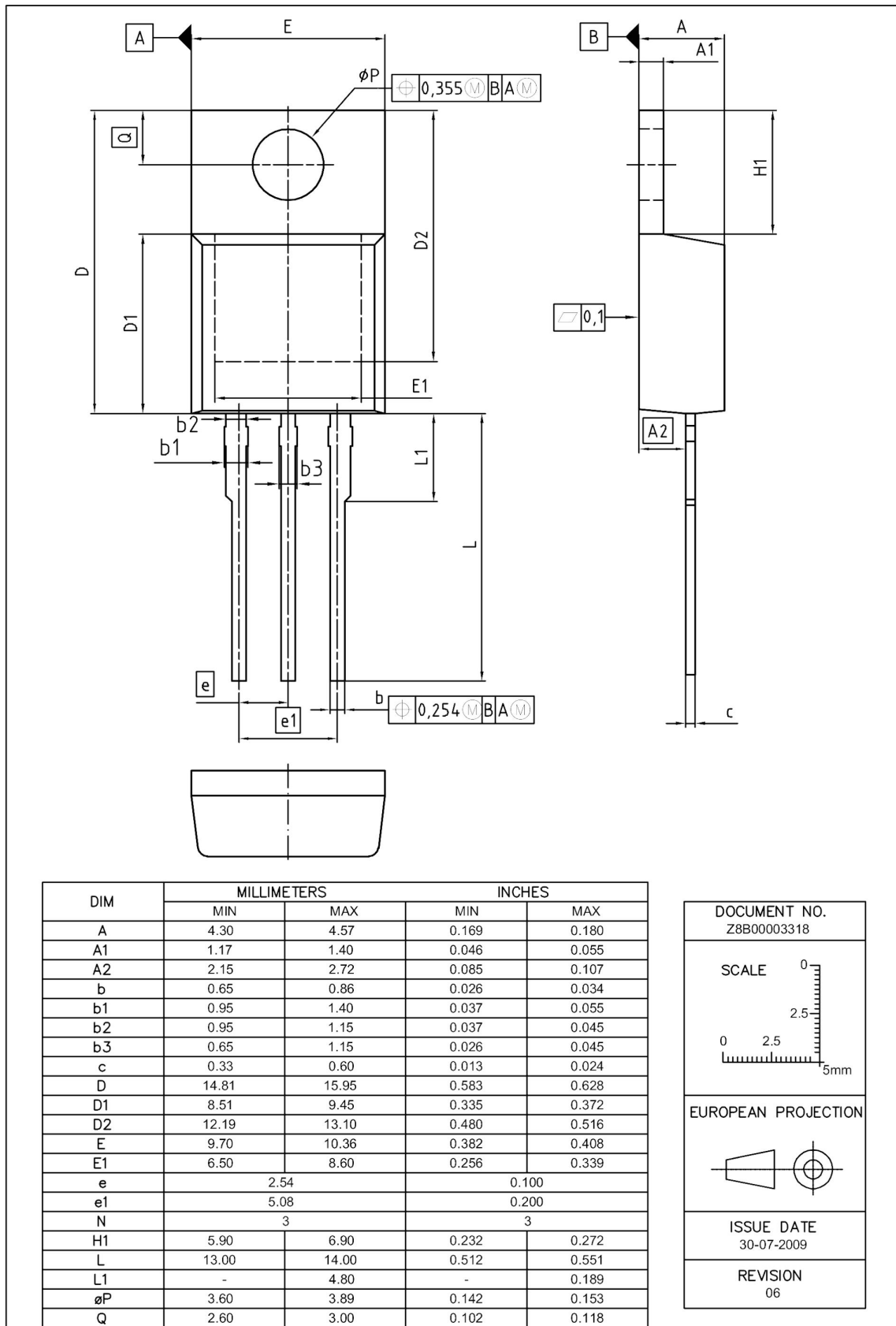

Figure 2 Outline PG-TO 220, dimensions in mm/inches

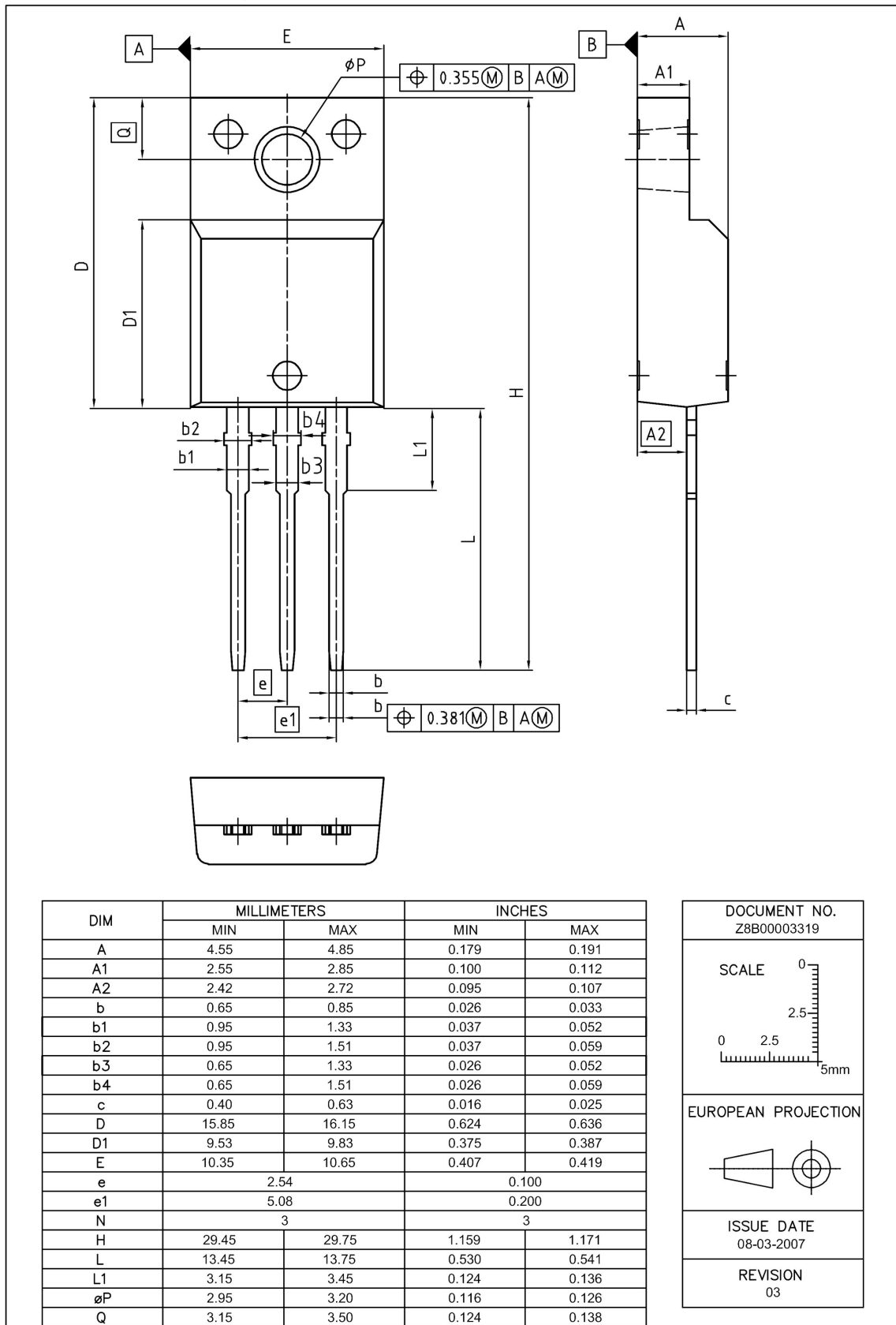

Figure 3 Outline PG-TO 220 FullPAK, dimensions in mm/inches

8 Appendix A

Table 12 Related Links

- IFX CoolMOS™ P6 Webpage: www.infineon.com
- IFX CoolMOS™ P6 application note: www.infineon.com
- IFX CoolMOS™ P6 simulation model: www.infineon.com
- IFX Design tools: www.infineon.com

Revision History

IPW60R125P6, IPP60R125P6, IPA60R125P6

Revision: 2014-03-07, Rev. 2.0

Previous Revision

Revision	Date	Subjects (major changes since last revision)
2.0	2014-03-07	Release of final version

We Listen to Your Comments

Any information within this document that you feel is wrong, unclear or missing at all? Your feedback will help us to continuously improve the quality of this document. Please send your proposal (including a reference to this document) to:

erratum@infineon.com

Published by

Infineon Technologies AG

81726 München, Germany

© 2014 Infineon Technologies AG

All Rights Reserved.

Legal Disclaimer

The information given in this document shall in no event be regarded as a guarantee of conditions or characteristics. With respect to any examples or hints given herein, any typical values stated herein and/or any information regarding the application of the device, Infineon Technologies hereby disclaims any and all warranties and liabilities of any kind, including without limitation, warranties of non-infringement of intellectual property rights of any third party.

Information

For further information on technology, delivery terms and conditions and prices please contact your nearest Infineon Technologies Office (www.infineon.com).

Warnings

Due to technical requirements, components may contain dangerous substances. For information on the types in question, please contact the nearest Infineon Technologies Office.

The Infineon Technologies component described in this Data Sheet may be used in life-support devices or systems and/or automotive, aviation and aerospace applications or systems only with the express written approval of Infineon Technologies, if a failure of such components can reasonably be expected to cause the failure of that life-support, automotive, aviation and aerospace device or system or to affect the safety or effectiveness of that device or system. Life support devices or systems are intended to be implanted in the human body or to support and/or maintain and sustain and/or protect human life. If they fail, it is reasonable to assume that the health of the user or other persons may be endangered.

Looking for pricing, stock, or lifecycle information?

Click below to explore more details on WIN SOURCE:

-  [View IPP60R125P6XKSA1 on WIN SOURCE](#)
-  [Infineon Technologies Information](#)

Optimize Your Supply Chain with WIN SOURCE Solutions

-  Global Sourcing Solution
-  Obsolete Management
-  Cost Control Management
-  Shortage Management
-  Alternative Solution
-  Excess Inventory Management