



**THE DATASHEET OF
IPP65R074C6XKSA1**



MOSFET

650V CoolMOS™ C6 Power Transistor

CoolMOS™ is a revolutionary technology for high voltage power MOSFETs, designed according to the superjunction (SJ) principle and pioneered by Infineon Technologies. CoolMOS™ C6 series combines the experience of the leading SJ MOSFET supplier with high class innovation. The resulting devices provide all benefits of a fast switching SJ MOSFET while not sacrificing ease of use. Extremely low switching and conduction losses make switching applications even more efficient, more compact, lighter and cooler.

Features

- Extremely low losses due to very low FOM $R_{\text{dson}} \cdot Q_{\text{g}}$ and E_{oss}
- Very high commutation ruggedness
- Easy to use/drive
- Pb-free plating, Halogen free mold compound
- Qualified for industrial grade applications according to JEDEC (J-STD20 and JESD22)

Potential applications

PFC stages, hard switching PWM stages and resonant switching PWM stages for e.g. PC Silverbox, Adapter, LCD & PDP TV, Lighting, Server, Telecom, UPS and Solar.

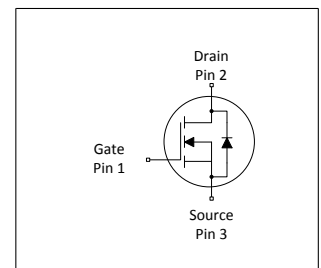
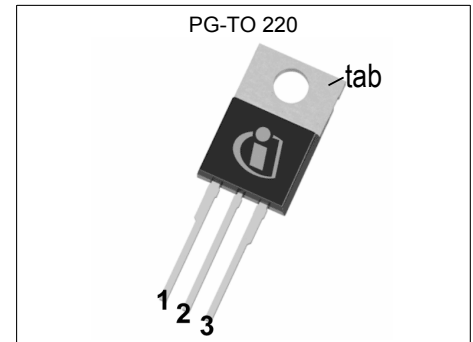

Table 1 Key Performance Parameters

Parameter	Value	Unit
$V_{\text{DS}} @ T_{\text{jmax}}$	700	V
$R_{\text{DS(on),max}}$	0.074	Ω
$Q_{\text{g,typ}}$	138	nC
$I_{\text{D,pulse}}$	151	A
$E_{\text{oss}} @ 400\text{V}$	10.8	μJ
Body diode di/dt	300	$\text{A}/\mu\text{s}$

Type / Ordering Code	Package	Marking	Related Links
IPP65R074C6	PG-TO 220-3	65C6074	see Appendix A

Table of Contents

Description	1
Table of Contents	2
Maximum ratings	3
Thermal characteristics	4
Electrical characteristics	5
Electrical characteristics diagrams	7
Test Circuits	11
Package Outlines	12
Appendix A	13
Revision History	14
Trademarks	14
Disclaimer	14

1 Maximum ratings

at $T_j = 25^\circ\text{C}$, unless otherwise specified

Table 2 Maximum ratings

Parameter	Symbol	Values			Unit	Note / Test Condition
		Min.	Typ.	Max.		
Continuous drain current ¹⁾	I_D			57.7	A	$T_C = 25^\circ\text{C}$
				31.6		$T_C = 100^\circ\text{C}$
Pulsed drain current ²⁾	$I_{D,pulse}$			151	A	$T_C = 25^\circ\text{C}$
Avalanche energy, single pulse	E_{AS}			915	mJ	$I_D = 8.1\text{A}$, $V_{DD} = 50\text{V}$
Avalanche energy, repetitive	E_{AR}			1.40	mJ	$I_D = 8.1\text{A}$, $V_{DD} = 50\text{V}$
Avalanche current, repetitive	I_{AR}			8.1	A	
MOSFET dv/dt ruggedness	dv/dt			50	V/ns	$V_{DS} = 0 \dots 480\text{V}$
Gate source voltage	V_{GS}	-20		20	V	static
		-30		30		AC ($f > 1\text{ Hz}$)
Power dissipation (non FullPAK) PG-TO 220	P_{tot}			480.8	W	$T_C = 25^\circ\text{C}$
Operating and storage temperature	T_j, T_{stg}	-55		150	$^\circ\text{C}$	
Mounting torque (non FullPAK) PG-TO 220				60	Ncm	M3 and M3.5 screws
Continuous diode forward current	I_S			50.0	A	$T_C = 25^\circ\text{C}$
Diode pulse current	$I_{S,pulse}$			151	A	$T_C = 25^\circ\text{C}$
Reverse diode dv/dt ³⁾	dv/dt			15	V/ns	$V_{DS} = 0 \dots 480\text{V}$, $I_{SD} \leq I_D$, $T_j = 25^\circ\text{C}$
Maximum diode commutation speed	di_f/dt			300	A/ μs	

¹⁾ Limited by $T_{j,max}$. Maximum duty cycle $D=0.75$

²⁾ Pulse width t_p limited by $T_{j,max}$

³⁾ $V_{peak} < V_{(BR)DSS}$, $T_j < T_{j,max}$, identical low side and high side switch with same R_g

2 Thermal characteristics

Table 3 Thermal characteristics PG-TO 220

Parameter	Symbol	Values			Unit	Note / Test Condition
		Min.	Typ.	Max.		
Thermal resistance, junction - case	R_{thJC}			0.26	°C/W	
Thermal resistance, junction - ambient	R_{thJA}			62	°C/W	leaded
Soldering temperature, wavesoldering only allowed at leads	T_{sold}			260	°C	1.6 mm (0.063 in.) from case for 10s

3 Electrical characteristics

at $T_j = 25^\circ\text{C}$, unless otherwise specified

Table 4 Static characteristics

Parameter	Symbol	Values			Unit	Note / Test Condition
		Min.	Typ.	Max.		
Drain-source breakdown voltage	$V_{(BR)DSS}$	650			V	$V_{GS} = 0V, I_D = 1mA$
Gate threshold voltage	$V_{GS(th)}$	2.5	3	3.5	V	$V_{DS} = V_{GS}, I_D = 1.4mA$
Zero gate voltage drain current	I_{DSS}			5	μA	$V_{DS} = 650V, V_{GS} = 0V, T_j = 25^\circ\text{C}$
			50			$V_{DS} = 650V, V_{GS} = 0V, T_j = 150^\circ\text{C}$
Gate-source leakage current	I_{GSS}			100	nA	$V_{GS} = 20V, V_{DS} = 0V$
Drain-source on-state resistance	$R_{DS(on)}$		0.067	0.074	Ω	$V_{GS} = 10V, I_D = 13.9A, T_j = 25^\circ\text{C}$
			0.173			$V_{GS} = 10V, I_D = 13.9A, T_j = 150^\circ\text{C}$
Gate resistance	R_G		0.6		Ω	$f = 1\text{MHz}$, open drain

Table 5 Dynamic characteristics

Parameter	Symbol	Values			Unit	Note / Test Condition
		Min.	Typ.	Max.		
Input capacitance	C_{iss}		3020		pF	$V_{GS} = 0V, V_{DS} = 100V, f = 1\text{MHz}$
Output capacitance	C_{oss}		170		pF	
Effective output capacitance, energy related ¹⁾	$C_{o(er)}$		118		pF	$V_{GS} = 0V, V_{DS} = 0 \dots 480V$
Effective output capacitance, time related ²⁾	$C_{o(tr)}$		580		pF	$I_D = \text{constant}, V_{GS} = 0V, V_{DS} = 0 \dots 480V$
Turn-on delay time	$t_{d(on)}$		11		ns	$V_{DD} = 400V, V_{GS} = 13V, I_D = 20.8A, R_G = 1.8\Omega$
Rise time	t_r		7		ns	
Turn-off delay time	$t_{d(off)}$		56		ns	
Fall time	t_f		4		ns	

Table 6 Gate charge characteristics

Parameter	Symbol	Values			Unit	Note / Test Condition
		Min.	Typ.	Max.		
Gate to source charge	Q_{gs}		17		nC	$V_{DD} = 480V, I_D = 20.8A, V_{GS} = 0 \text{ to } 10V$
Gate to drain charge	Q_{gd}		71		nC	
Gate charge total	Q_g		138		nC	
Gate plateau voltage	$V_{plateau}$		5.5		V	

¹⁾ $C_{o(er)}$ is a fixed capacitance that gives the same stored energy as C_{oss} while V_{DS} is rising from 0 to 80% $V_{(BR)DSS}$

²⁾ $C_{o(tr)}$ is a fixed capacitance that gives the same charging time as C_{oss} while V_{DS} is rising from 0 to 80% $V_{(BR)DSS}$

Table 7 Reverse diode characteristics

Parameter	Symbol	Values			Unit	Note / Test Condition
		Min.	Typ.	Max.		
Diode forward voltage	V_{SD}		0.9		V	$V_{GS} = 0V, I_F = 20.8A, T_j = 25^\circ C$
Reverse recovery time	t_{rr}		560		ns	$V_R = 400V, I_F = 20.8A,$ $di_F/dt = 100A/\mu s$
Reverse recovery charge	Q_{rr}		12		μC	
Peak reverse recovery current	I_{rrm}		40		A	

4 Electrical characteristics diagrams

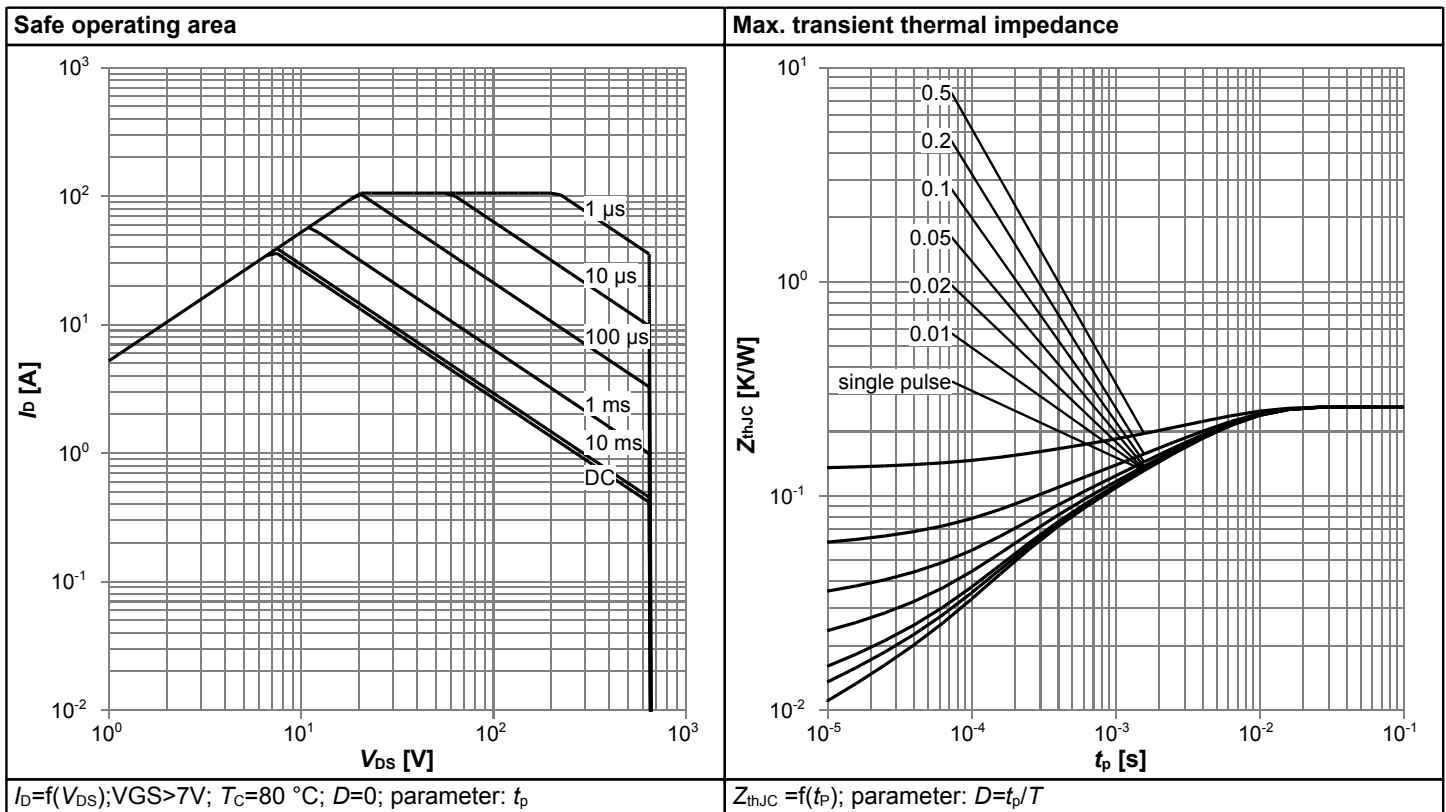
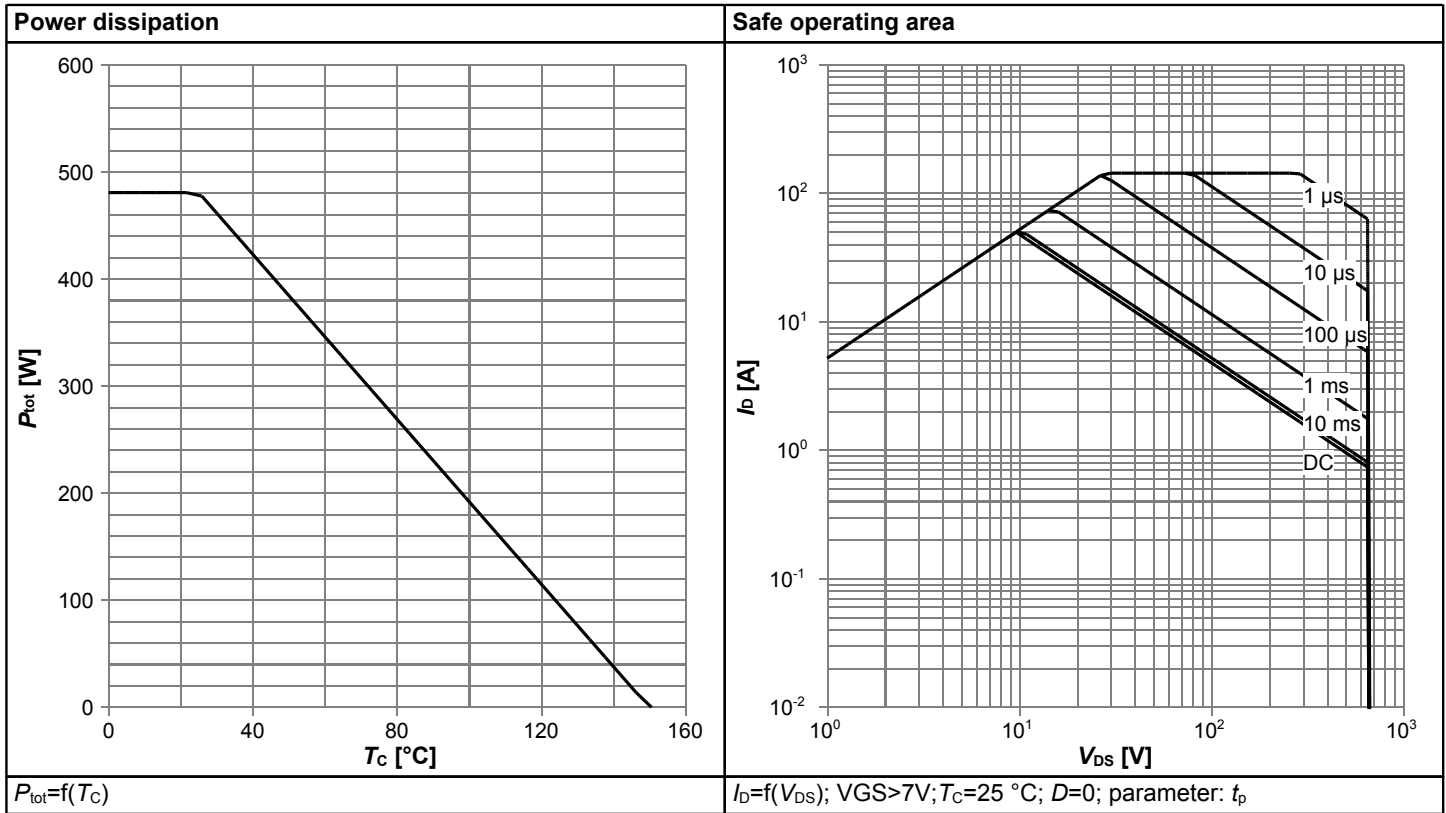

Typ. output characteristics

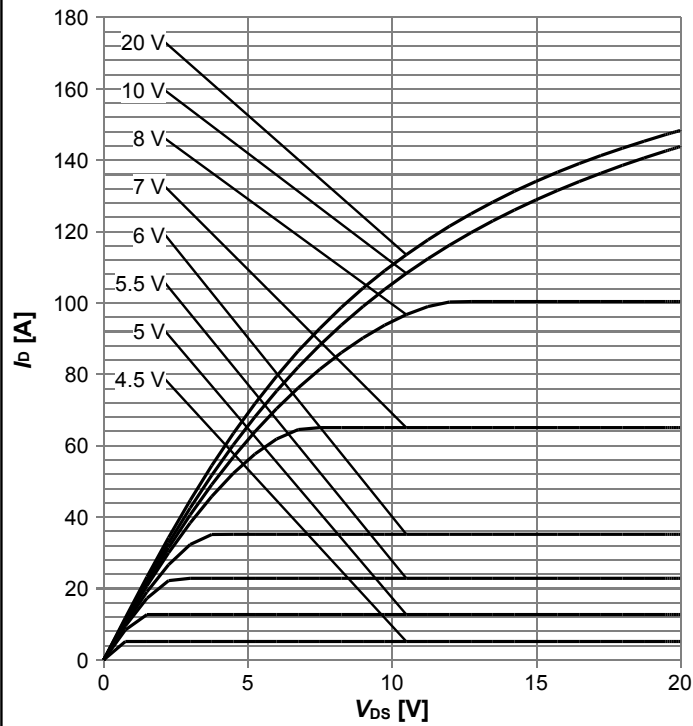

$I_D=f(V_{DS})$; $T_j=25\text{ °C}$; parameter: V_{GS}

Typ. output characteristics

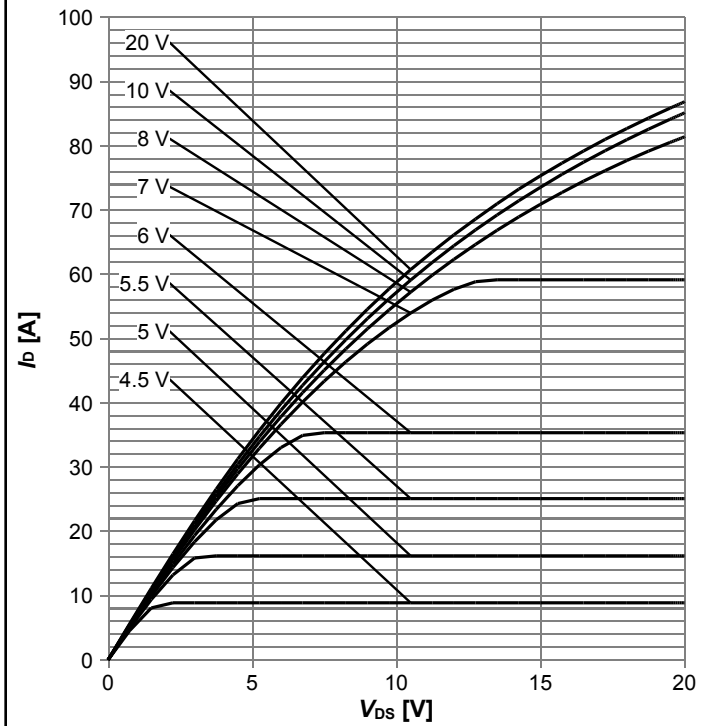

$I_D=f(V_{DS})$; $T_j=125\text{ °C}$; parameter: V_{GS}

Typ. drain-source on-state resistance

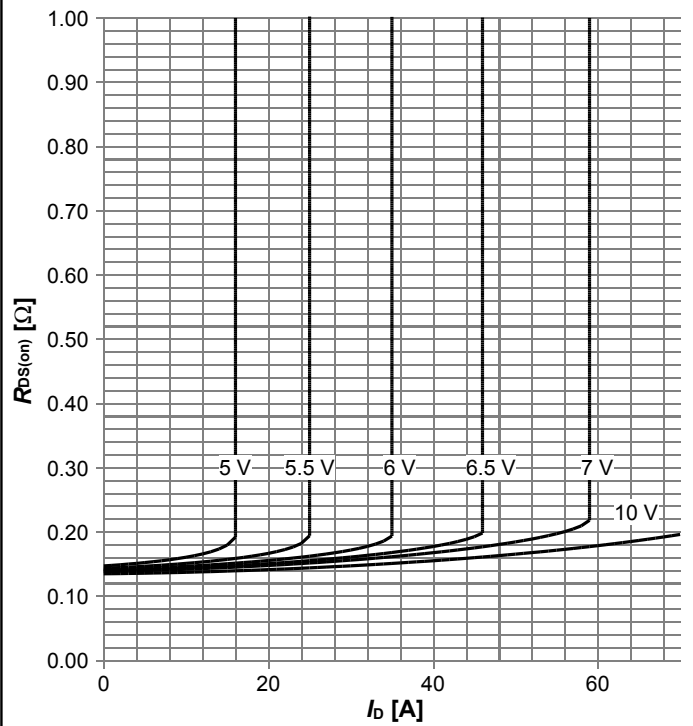

$R_{DS(on)}=f(I_D)$; $T_j=125\text{ °C}$; parameter: V_{GS}

Drain-source on-state resistance

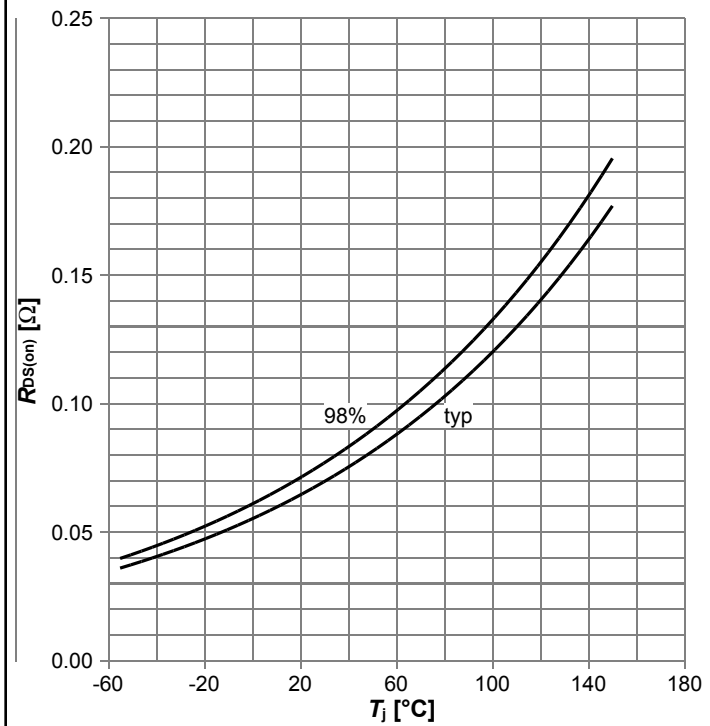

$R_{DS(on)}=f(T_j)$; $I_D=13.9\text{ A}$; $V_{GS}=10\text{ V}$

650V CoolMOS™ C6 Power Transistor

IPP65R074C6

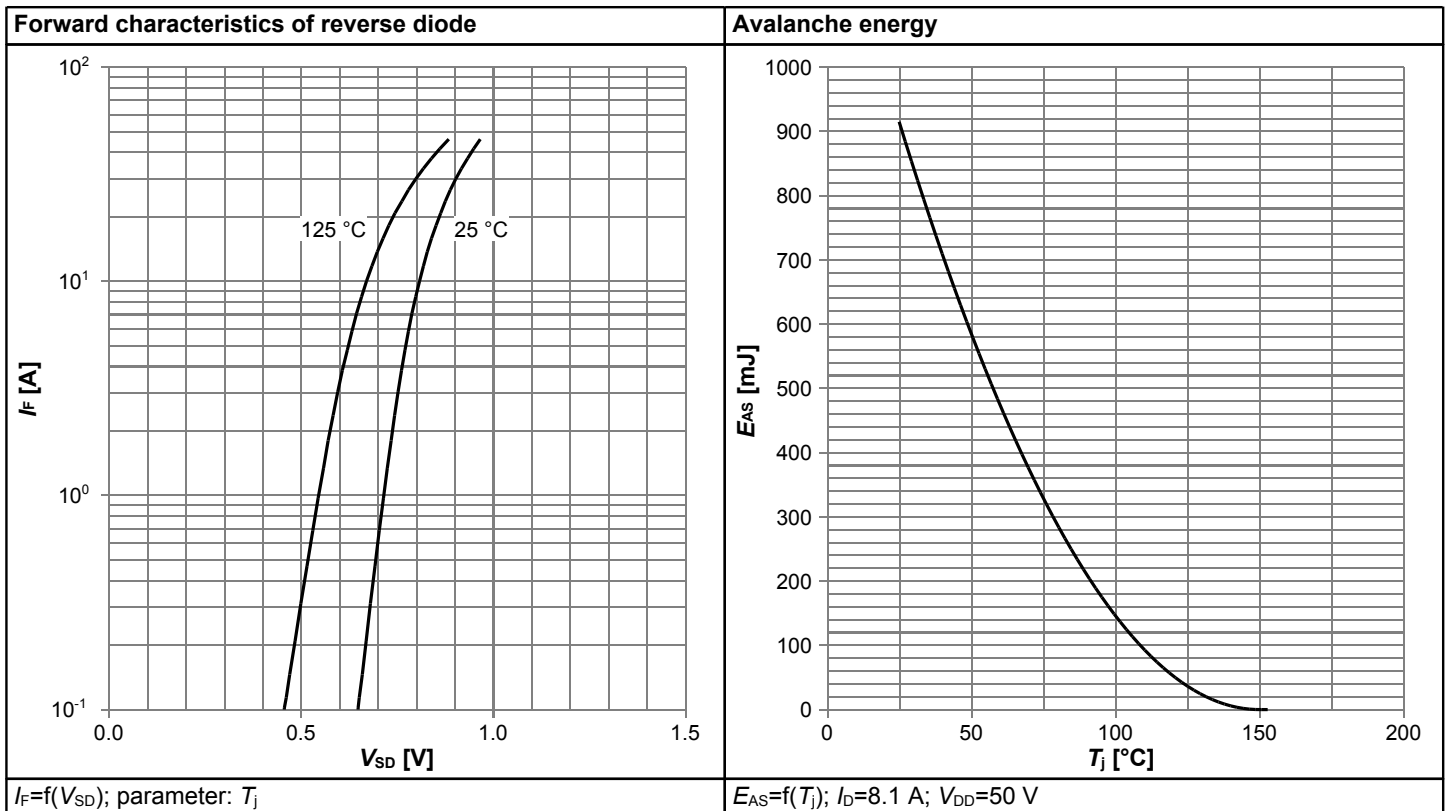
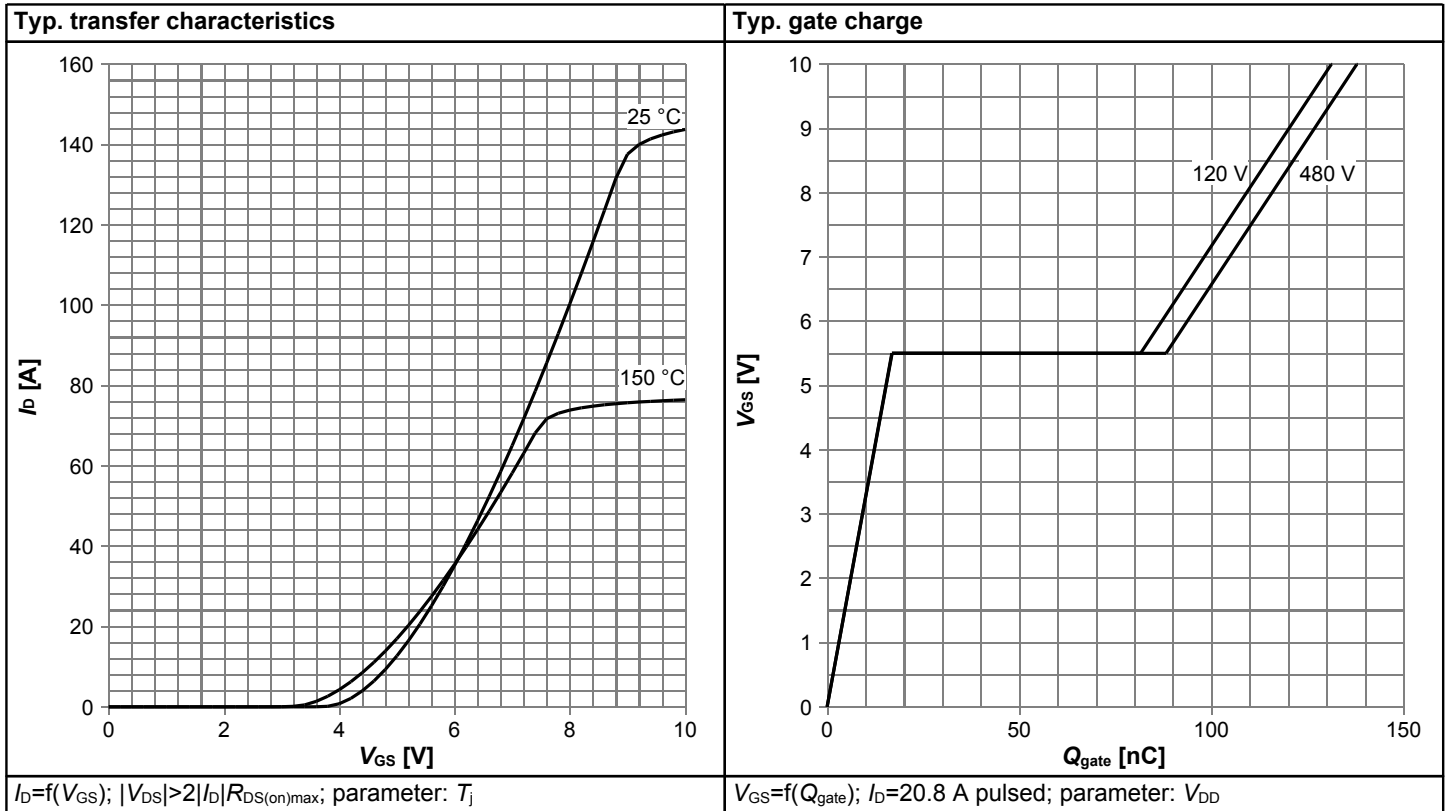

650V CoolMOS™ C6 Power Transistor

IPP65R074C6

Drain-source breakdown voltage

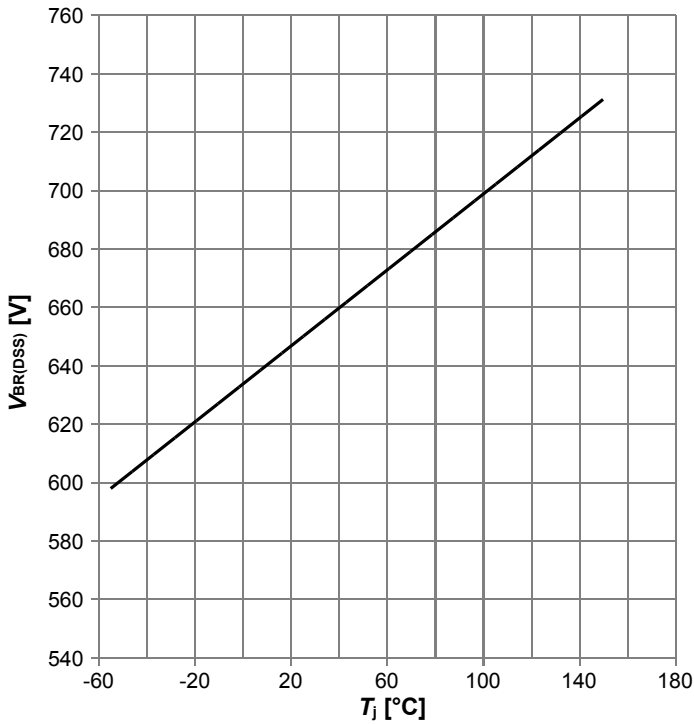

$V_{BR(DSS)} = f(T_j); I_D = 1 \text{ mA}$

Typ. capacitances

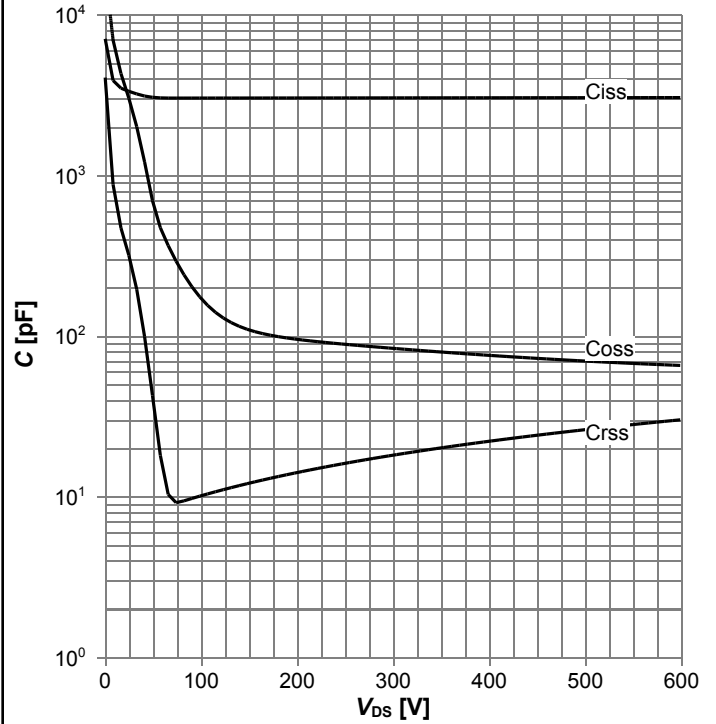

$C = f(V_{DS}); V_{GS} = 0 \text{ V}; f = 1 \text{ MHz}$

Typ. C_oss stored energy

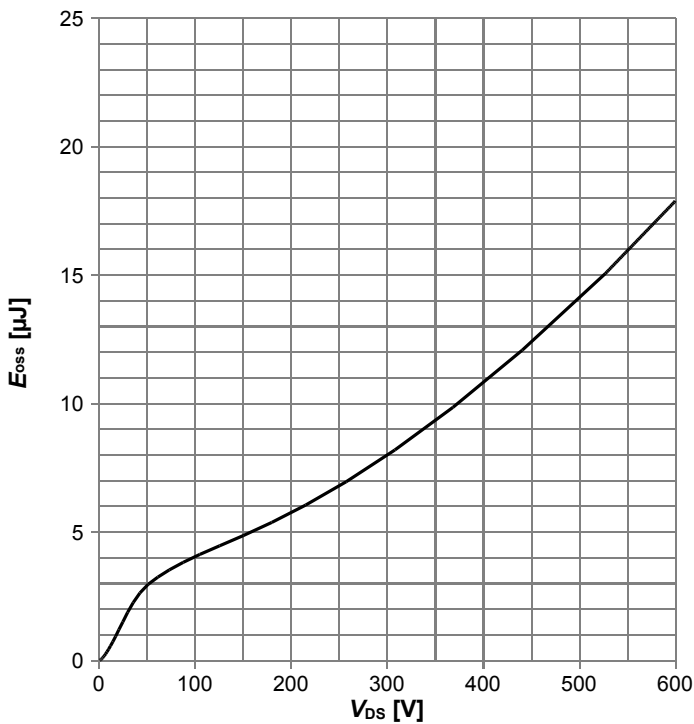

$E_{oss} = f(V_{DS})$

5 Test Circuits

Table 8 Diode characteristics



Table 9 Switching times



Table 10 Unclamped inductive load



6 Package Outlines

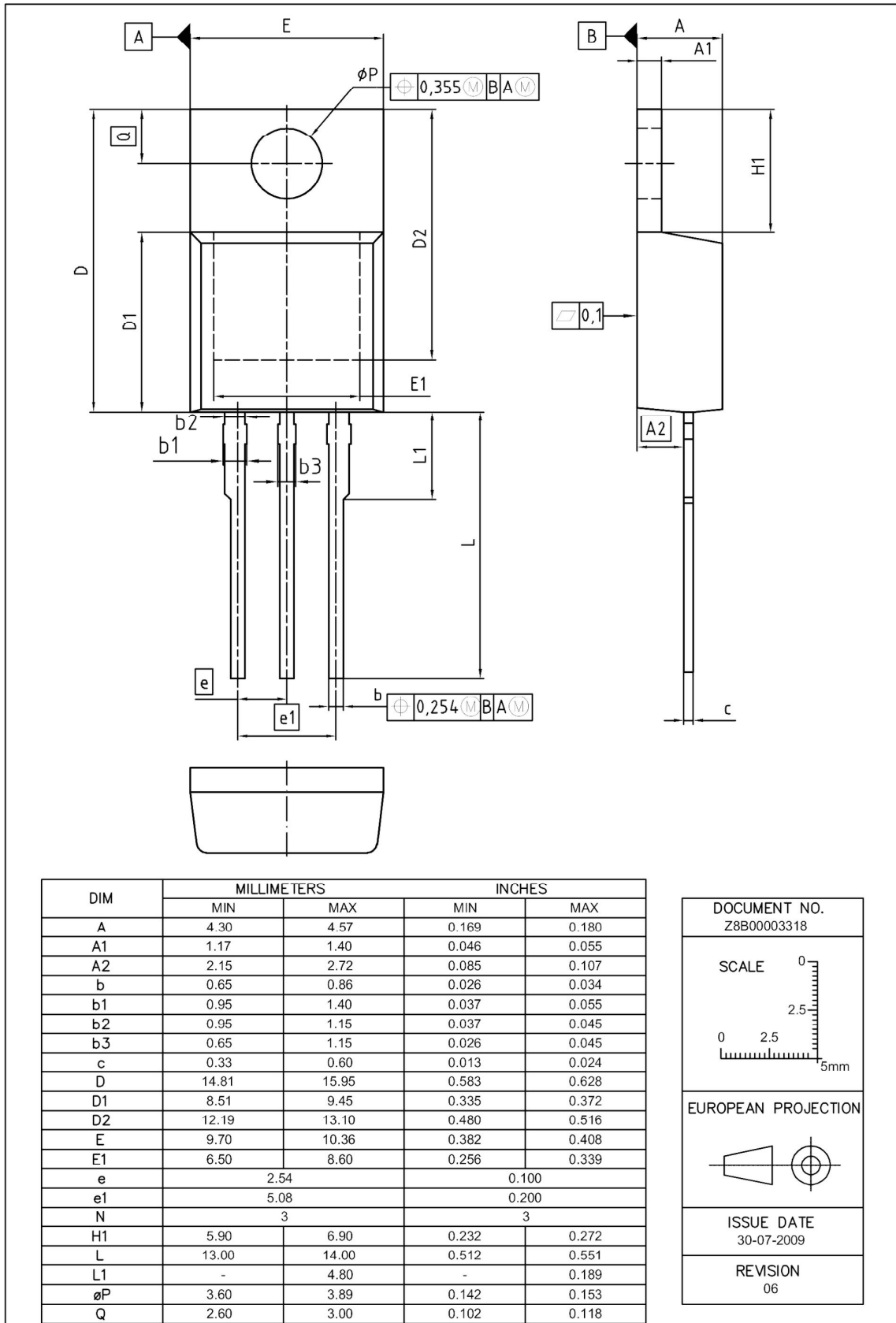

Figure 1 Outline PG-TO 220-3, dimensions in mm/inches

7 Appendix A

Table 11 Related Links

- **IFX C6 Product Brief:** www.infineon.com
- **IFX C6 Portfolio:** www.infineon.com
- **IFX CoolMOS Webpage:** www.infineon.com
- **IFX Design Tools:** www.infineon.com

Revision History

IPP65R074C6

Revision: 2018-01-29, Rev. 2.2

Previous Revision

Revision	Date	Subjects (major changes since last revision)
2.1	2011-09-14	Final Datasheet Release
2.2	2018-01-29	Changed I_GSS Test condition in Table 4, Page 6

Trademarks of Infineon Technologies AG

AURIX™, C166™, CanPAK™, CIPOS™, CoolGaN™, CoolMOS™, CoolSET™, CoolSiC™, CORECONTROL™, CROSSAVE™, DAVE™, DI-POL™, DrBlade™, EasyPIM™, EconoBRIDGE™, EconoDUAL™, EconoPACK™, EconoPIM™, EiceDRIVER™, eupec™, FCOS™, HITFET™, HybridPACK™, Infineon™, ISOFACE™, IsoPACK™, i-Wafer™, MIPAQ™, ModSTACK™, my-d™, NovalithIC™, OmniTune™, OPTIGA™, OptiMOS™, ORIGA™, POWERCODE™, PRIMARION™, PrimePACK™, PrimeSTACK™, PROFET™, PRO-SIL™, RASIC™, REAL3™, ReverSave™, SatRIC™, SIEGET™, SiPMOS™, SmartLEWIS™, SOLID FLASH™, SPOC™, TEMPFET™, thinQ!™, TRENCHSTOP™, TriCore™.

Trademarks updated August 2015

Other Trademarks

All referenced product or service names and trademarks are the property of their respective owners.

We Listen to Your Comments

Any information within this document that you feel is wrong, unclear or missing at all? Your feedback will help us to continuously improve the quality of this document. Please send your proposal (including a reference to this document) to:

erratum@infineon.com

Published by

Infineon Technologies AG

81726 München, Germany

© 2018 Infineon Technologies AG

All Rights Reserved.

Legal Disclaimer

The information given in this document shall in no event be regarded as a guarantee of conditions or characteristics ("Beschaffheitsgarantie").

With respect to any examples, hints or any typical values stated herein and/or any information regarding the application of the product, Infineon Technologies hereby disclaims any and all warranties and liabilities of any kind, including without limitation warranties of non-infringement of intellectual property rights of any third party.

In addition, any information given in this document is subject to customer's compliance with its obligations stated in this document and any applicable legal requirements, norms and standards concerning customer's products and any use of the product of Infineon Technologies in customer's applications.

The data contained in this document is exclusively intended for technically trained staff. It is the responsibility of customer's technical departments to evaluate the suitability of the product for the intended application and the completeness of the product information given in this document with respect to such application.

Information

For further information on technology, delivery terms and conditions and prices please contact your nearest Infineon Technologies Office (www.infineon.com).

Warnings

Due to technical requirements, components may contain dangerous substances. For information on the types in question, please contact the nearest Infineon Technologies Office.

The Infineon Technologies component described in this Data Sheet may be used in life-support devices or systems and/or automotive, aviation and aerospace applications or systems only with the express written approval of Infineon Technologies, if a failure of such components can reasonably be expected to cause the failure of that life-support, automotive, aviation and aerospace device or system or to affect the safety or effectiveness of that device or system. Life support devices or systems are intended to be implanted in the human body or to support and/or maintain and sustain and/or protect human life. If they fail, it is reasonable to assume that the health of the user or other persons may be endangered.

Looking for pricing, stock, or lifecycle information?

Click below to explore more details on WIN SOURCE:

- ⊖ [View IPP65R074C6XKSA1 on WIN SOURCE](#)
- ⊖ [Infineon Technologies Information](#)

Optimize Your Supply Chain with WIN SOURCE Solutions

- ✓ Global Sourcing Solution
- ✓ Obsolete Management
- ✓ Cost Control Management
- ✓ Shortage Management
- ✓ Alternative Solution
- ✓ Excess Inventory Management