



**THE DATASHEET OF
IRF7807D2TR**



IRF7807D2

FETKY™ MOSFET / SCHOTTKY DIODE

- Co-Pack N-channel HEXFET® Power MOSFET and Schottky Diode
- Ideal for Synchronous Rectifiers in DC-DC Converters up to 5A Output
- Low Conduction Losses
- Low Switching Losses
- Low Vf Schottky Rectifier

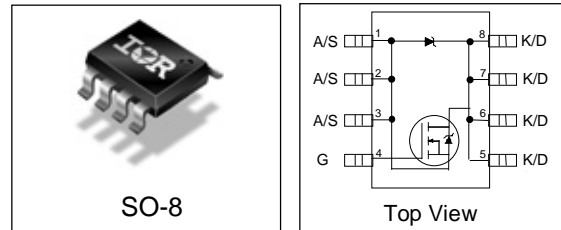

Description

The FETKY™ family of Co-Pack HEXFET® MOSFETs and Schottky diodes offers the designer an innovative, board space saving solution for switching regulator and power management applications. HEXFET power MOSFETs utilize advanced processing techniques to achieve extremely low on-resistance per silicon area. Combining this technology with International Rectifier's low forward drop Schottky rectifiers results in an extremely efficient device suitable for use in a wide variety of portable electronics applications.

The SO-8 has been modified through a customized leadframe for enhanced thermal characteristics. The SO-8 package is designed for vapor phase, infrared or wave soldering techniques.

Device Features (Max Values)

	IRF7807D2
V_{DS}	30V
$R_{DS(on)}$	25mΩ
Q_g	14nC
Q_{SW}	5.2nC
Q_{oss}	21.6nC

Absolute Maximum Ratings

Parameter	Symbol	Max.	Units
Drain-Source Voltage	V_{DS}	30	V
Gate-Source Voltage	V_{GS}	±12	
Continuous Drain or Source Current ($V_{GS} \geq 4.5V$)	I_D	25°C	A
		70°C	
Pulsed Drain Current ^①	I_{DM}	66	
Power Dissipation	P_D	25°C	W
		70°C	
Schottky and Body Diode	$I_F (AV)$	25°C	A
Average Forward Current ^④		70°C	
Junction & Storage Temperature Range	T_J, T_{STG}	-55 to 150	°C

Thermal Resistance

Parameter	Symbol	Max.	Units
Maximum Junction-to-Ambient ^③	$R_{\theta JA}$	50	°C/W

Electrical Characteristics

Parameter		Min	Typ	Max	Units	Conditions
Drain-to-Source Breakdown Voltage*	$V_{(BR)DSS}$	30			V	$V_{GS} = 0V, I_D = 250\mu A$
Static Drain-Source on Resistance*	$R_{DS(on)}$		17	25	m Ω	$V_{GS} = 4.5V, I_D = 7A$ ②
Gate Threshold Voltage*	$V_{GS(th)}$	1.0			V	$V_{DS} = V_{GS}, I_D = 250\mu A$
Drain-Source Leakage Current*	I_{DSS}			90	μA	$V_{DS} = 24V, V_{GS} = 0V$
				7.2	mA	$V_{DS} = 24V, V_{GS} = 0V, T_j = 125^\circ C$
Gate-Source Leakage Current*	I_{GSS}			+/- 100	nA	$V_{GS} = +/-12V$
Total Gate Charge Synch FET*	Q_{gsync}		10.5	14	nC	$V_{DS} < 100mV, V_{GS} = 5V, I_D = 7A$
Total Gate Charge Control FET*	Q_{gcont}		12	17		$V_{DS} = 16V, V_{GS} = 5V, I_D = 7A$
Pre-Vth Gate-Source Charge	Q_{gs1}		2.1			$V_{DS} = 16V, I_D = 7A$
Post-Vth Gate-Source Charge	Q_{gs2}		0.76			
Gate to Drain Charge	Q_{gd}		2.9			
Switch Charge* ($Q_{gs2} + Q_{gd}$)	Q_{SW}		3.66	5.2		
Output Charge*	Q_{oss}		17.6	21.6		$V_{DS} = 16V, V_{GS} = 0$
Gate Resistance	R_g		1.2			Ω

Schottky Diode & Body Diode Ratings and Characteristics

Parameter		Min	Typ	Max	Units	Conditions
Diode Forward Voltage	V_{SD}			0.54	V	$T_j = 25^\circ C, I_s = 3A, V_{GS} = 0V$ ②
				0.43		$T_j = 125^\circ C, I_s = 3A, V_{GS} = 0V$ ②
Reverse Recovery Time	t_{rr}		36		ns	$T_j = 25^\circ C, I_s = 7.0A, V_{DS} = 16V$
Reverse Recovery Charge	Q_{rr}		41		nC	$di/dt = 100A/\mu s$
Forward Turn-On Time	t_{on}	Intrinsic turn-on time is negligible (turn-on is dominated by $L_s + L_D$)				

- ① Repetitive rating; pulse width limited by max. junction temperature.
 ② Pulse width $\leq 300\mu s$; duty cycle $\leq 2\%$.
 ③ When mounted on 1 inch square copper board, $t < 10$ sec.
 ④ 50% Duty Cycle, Rectangular
 * Devices are 100% tested to these parameters.

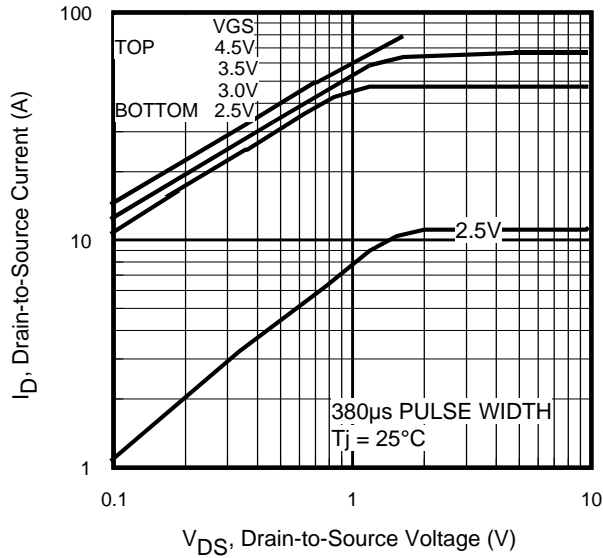

Fig 1. Typical Output Characteristics

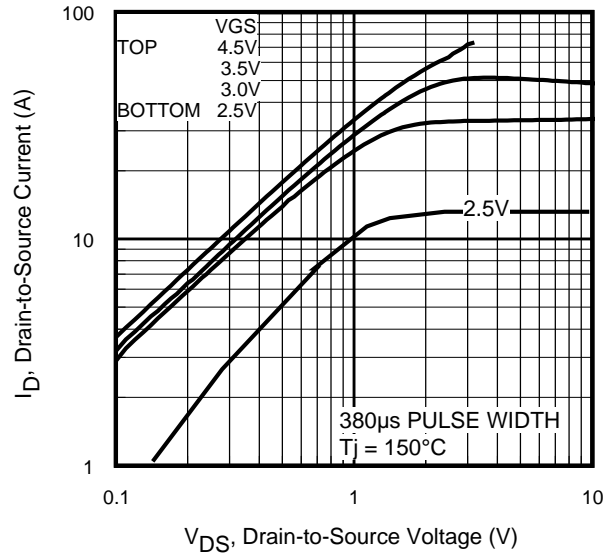

Fig 2. Typical Output Characteristics

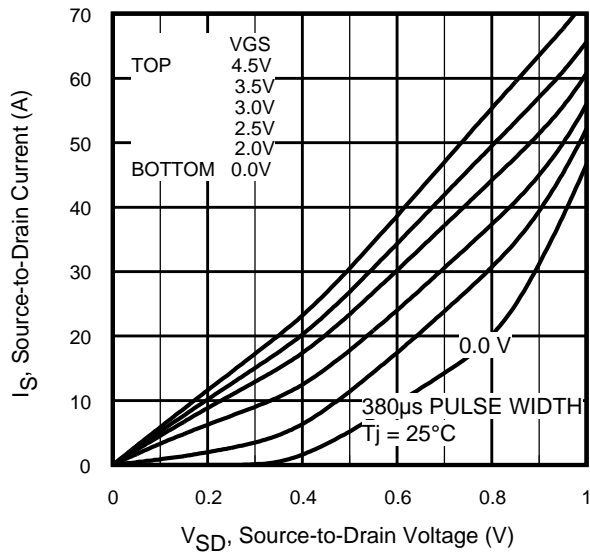

Fig 3. Typical Reverse Output Characteristics

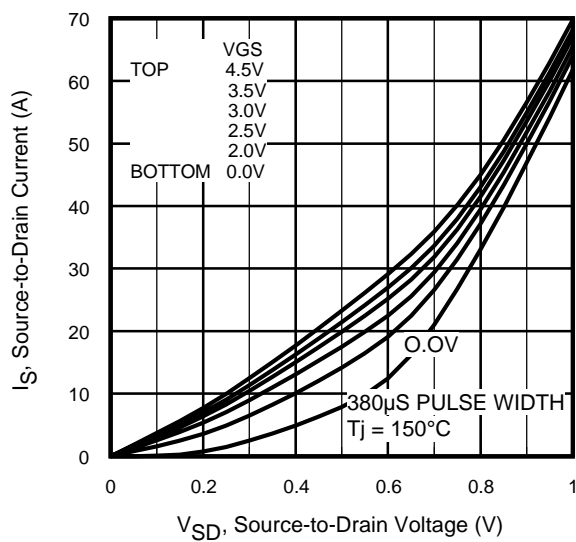

Fig 4. Typical Reverse Output Characteristics

IRF7807D2

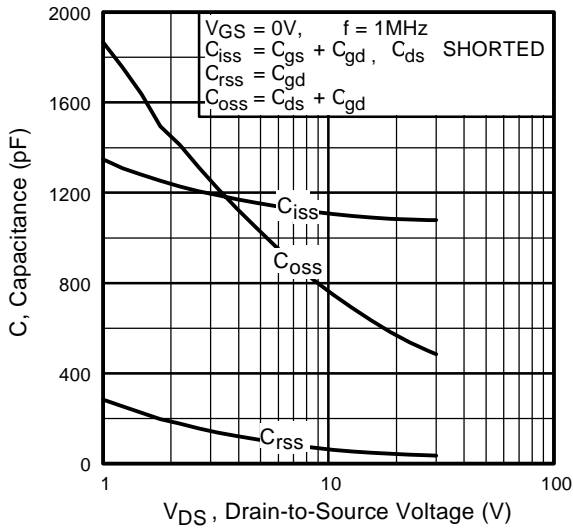

Fig 5. Typical Capacitance Vs. Drain-to-Source Voltage

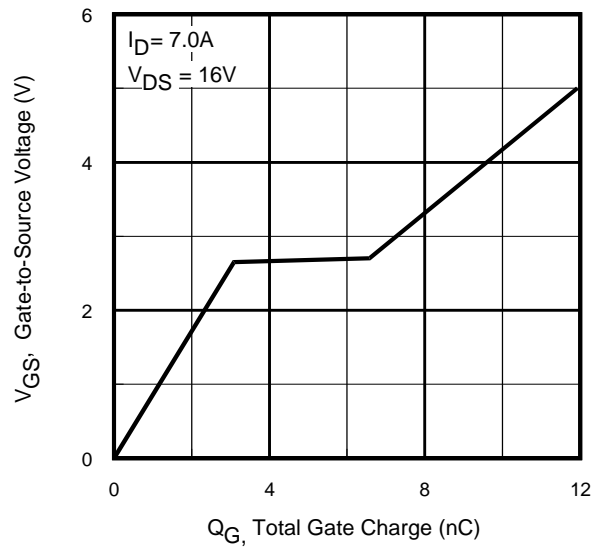

Fig 6. Typical Gate Charge Vs. Gate-to-Source Voltage

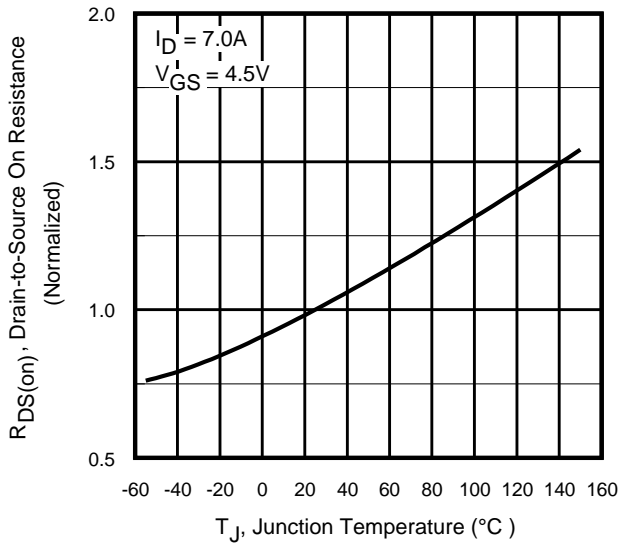

Fig 7. Normalized On-Resistance Vs. Temperature

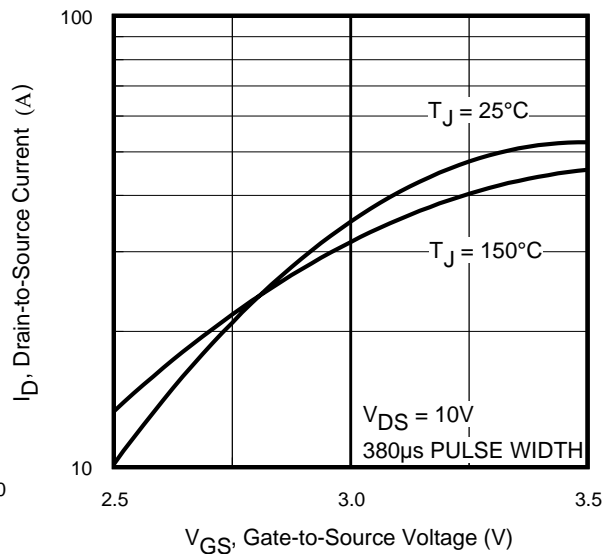

Fig 8. Typical Transfer Characteristics

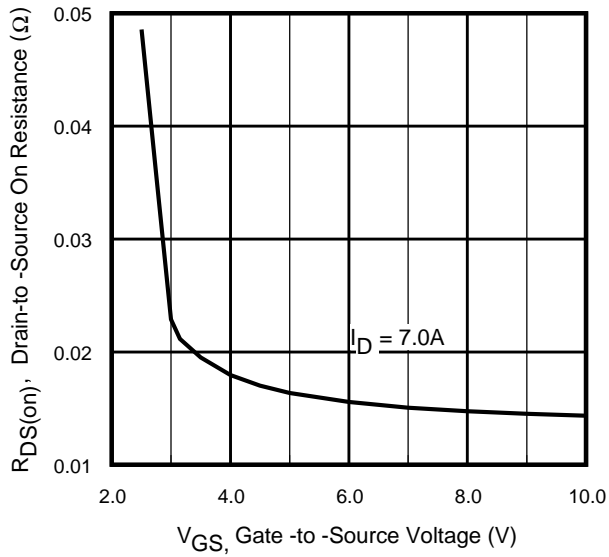

Fig 9. On-Resistance Vs. Gate Voltage

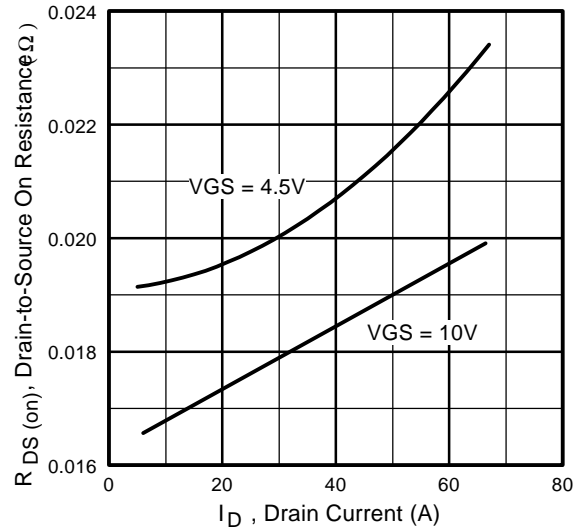

Fig 10. On-Resistance Vs. Drain Current

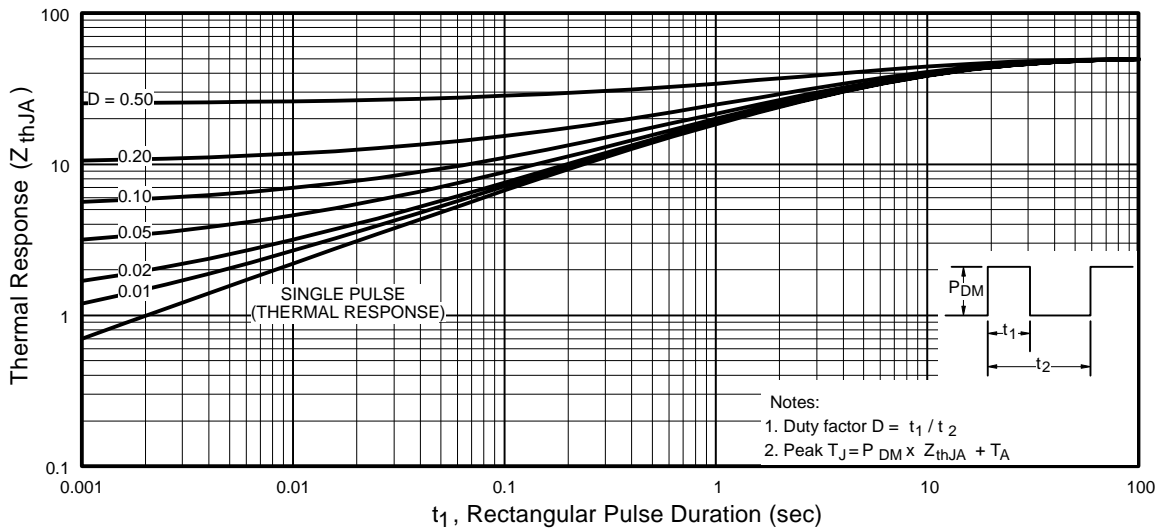

Fig 11. Maximum Effective Transient Thermal Impedance, Junction-to-Ambient (MOSFET)

Mosfet, Body Diode & Schottky Diode Characteristics

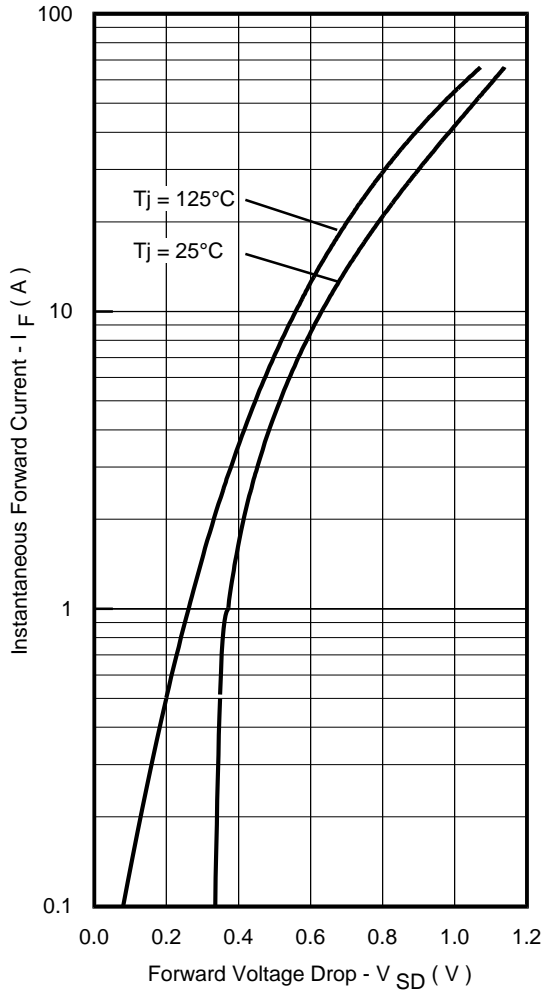

Fig. 12 - Typical Forward Voltage Drop Characteristics

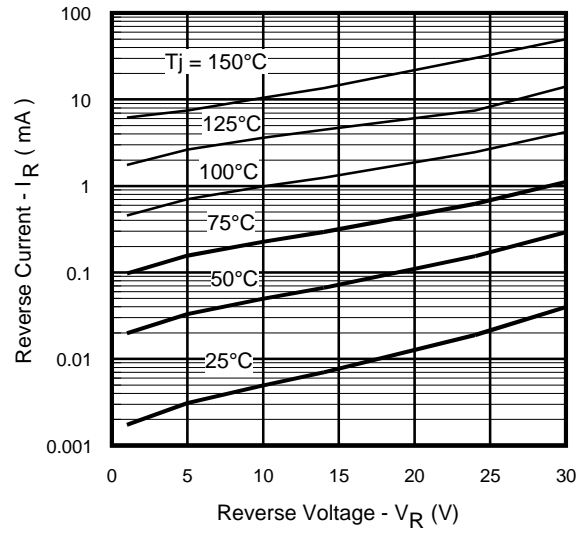
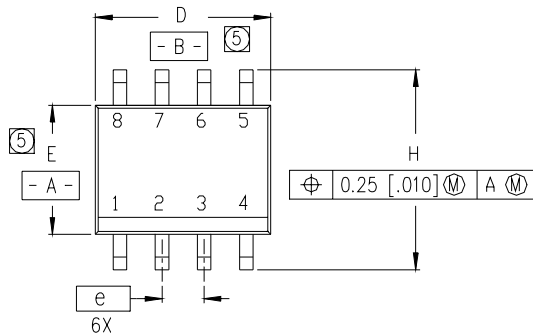
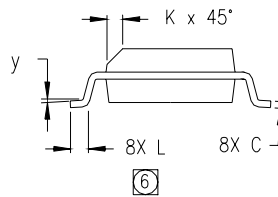
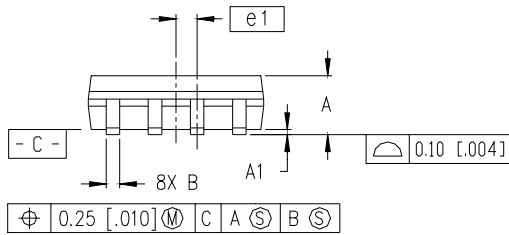

Fig. 13 - Typical Values of Reverse Current Vs. Reverse Voltage

SO-8 Package Details



DIM	INCHES		MILLIMETERS	
	MIN	MAX	MIN	MAX
A	.0532	.0688	1.35	1.75
A1	.0040	.0098	0.10	0.25
B	.014	.018	0.36	0.46
C	.0075	.0098	0.19	0.25
D	.189	.196	4.80	4.98
E	.150	.157	3.81	3.99
e	.050	BASIC	1.27	BASIC
e1	.025	BASIC	0.635	BASIC
H	.2284	.2440	5.80	6.20
K	.011	.019	0.28	0.48
L	.016	.050	0.41	1.27
y	0°	8°	0°	8°



Part Marking

SO-8 (MS-012AA)

EXAMPLE: THIS IS AN IRF7807D1 (FETKY)

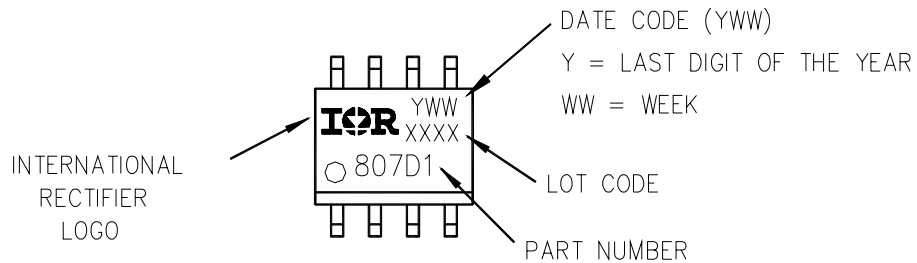

IRF7807D2

Tape and Reel

International
IR Rectifier

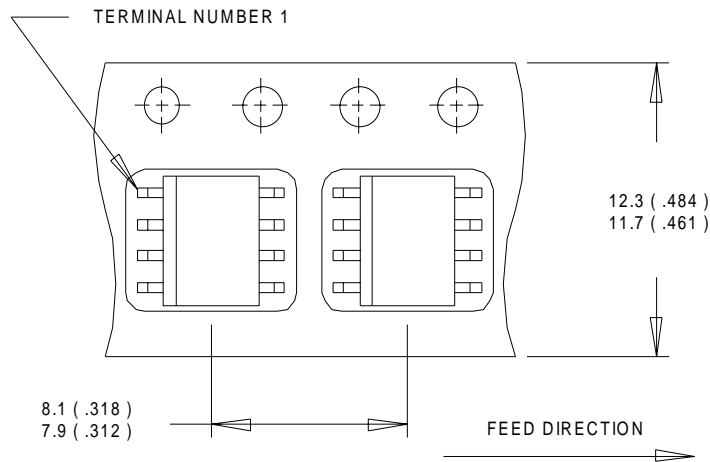

NOTES:

1. CONTROLLING DIMENSION : MILLIMETER.
2. ALL DIMENSIONS ARE SHOWN IN MILLIMETERS(INCHES).
3. OUTLINE CONFORMS TO EIA-481 & EIA-541.

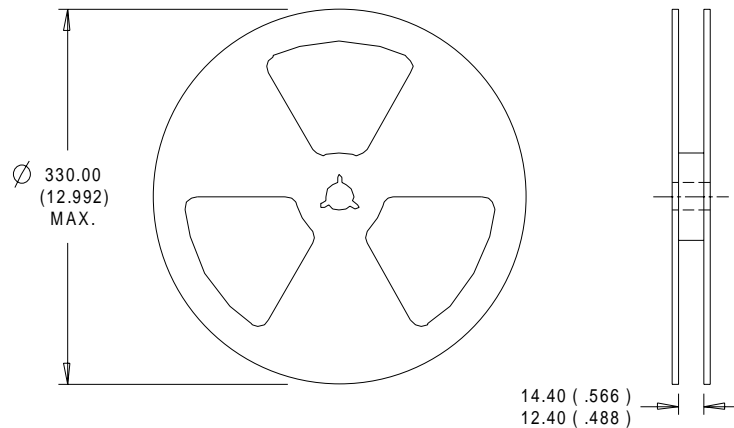

NOTES :

1. CONTROLLING DIMENSION : MILLIMETER.
2. OUTLINE CONFORMS TO EIA-481 & EIA-541.

International
IR Rectifier

WORLD HEADQUARTERS: 233 Kansas St., El Segundo, California 90245, Tel: (310) 322 3331

IR GREAT BRITAIN: Hurst Green, Oxted, Surrey RH8 9BB, UK Tel: ++ 44 1883 732020

IR CANADA: 15 Lincoln Court, Brampton, Ontario L6T3Z2, Tel: (905) 453 2200

IR GERMANY: Saalburgstrasse 157, 61350 Bad Homburg Tel: ++ 49 6172 96590

IR ITALY: Via Liguria 49, 10071 Borgaro, Torino Tel: ++ 39 11 451 0111

IR JAPAN: K&H Bldg., 2F, 30-4 Nishi-Ikebukuro 3-Chome, Toshima-Ku, Tokyo Japan 171 Tel: 81 3 3983 0086

IR SOUTHEAST ASIA: 1 Kim Seng Promenade, Great World City West Tower, 13-11, Singapore 237994 Tel: ++ 65 838 4630

IR TAIWAN: 16 Fl. Suite D. 207, Sec. 2, Tun Haw South Road, Taipei, 10673, Taiwan Tel: 886-2-2377-9936

Data and specifications subject to change without notice. 11/99

Looking for pricing, stock, or lifecycle information?

Click below to explore more details on WIN SOURCE:

 [View IRF7807D2TR on WIN SOURCE](#)

 [Infineon Technologies](#) Information

Optimize Your Supply Chain with WIN SOURCE Solutions

-  Global Sourcing Solution
-  Obsolete Management
-  Cost Control Management
-  Shortage Management
-  Alternative Solution
-  Excess Inventory Management