



THE DATASHEET OF IRG4BC15UDPBF



IRG4BC15UDPbF

INSULATED GATE BIPOLAR TRANSISTOR WITH ULTRAFAST SOFT RECOVERY DIODE UltraFast CoPack IGBT

Features

- UltraFast: Optimized for high frequencies from 10 to 30 kHz in hard switching
- IGBT Co-packaged with ultra-soft-recovery antiparallel diode
- Industry standard TO-220AB package
- Lead-Free

Benefits

- Best Value for Appliance and Industrial Applications
- High noise immune "Positive Only" gate drive- Negative bias gate drive not necessary
- For Low EMI designs- requires little or no snubbing
- Single Package switch for bridge circuit applications
- Compatible with high voltage Gate Driver IC's
- Allows simpler gate drive

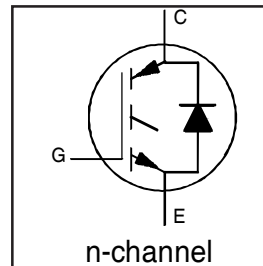

$V_{CES} = 600V$
$V_{CE(on)} \text{ typ.} = 2.02V$
@ $V_{GE} = 15V, I_C = 7.8A$

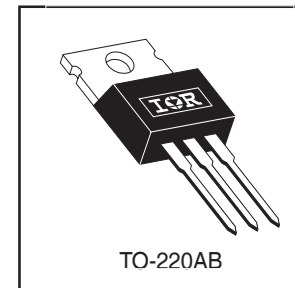

Absolute Maximum Ratings

	Parameter	Max.	Units
V_{CES}	Collector-to-Emitter Voltage	600	V
$I_C @ T_C = 25^\circ C$	Continuous Collector Current	14	A
$I_C @ T_C = 100^\circ C$	Continuous Collector Current	7.8	
I_{CM}	Pulsed Collector Current ①	42	
I_{LM}	Clamped Inductive Load Current ②	42	
$I_F @ T_C = 100^\circ C$	Diode Continuous Forward Current	4.0	
I_{FM}	Diode Maximum Forward Current	16	
V_{GE}	Gate-to-Emitter Voltage	± 20	V
$P_D @ T_C = 25^\circ C$	Maximum Power Dissipation	49	W
$P_D @ T_C = 100^\circ C$	Maximum Power Dissipation	19	
T_J	Operating Junction and Storage Temperature Range	-55 to +150	°C
T_{STG}			
	Mounting Torque, 6-32 or M3 Screw.	10 lbf•in (1.1 N•m)	

Thermal Resistance

	Parameter	Min.	Typ.	Max.	Units
$R_{\theta JC}$	Junction-to-Case - IGBT	—	—	2.7	°C/W
$R_{\theta JC}$	Junction-to-Case - Diode	—	—	7.0	
$R_{\theta CS}$	Case-to-Sink, flat, greased surface	—	0.50	—	
$R_{\theta JA}$	Junction-to-Ambient, typical socket mount	—	—	80	
Wt	Weight	—	2 (0.07)	—	g (oz)

IRG4BC15UDPbF

International
 Rectifier

Electrical Characteristics @ $T_J = 25^\circ\text{C}$ (unless otherwise specified)

	Parameter	Min.	Typ.	Max.	Units	Conditions	
$V_{(BR)CES}$	Collector-to-Emitter Breakdown Voltage ^③	600	—	—	V	$V_{GE} = 0V, I_C = 250\mu A$	
$\Delta V_{(BR)CES}/\Delta T_J$	Temperature Coeff. of Breakdown Voltage	—	0.63	—	V/°C	$V_{GE} = 0V, I_C = 1.0mA$	
$V_{CE(on)}$	Collector-to-Emitter Saturation Voltage	—	2.02	2.4	V	$V_{GE} = 15V$ $I_C = 7.8A$	
		—	2.56	—			$I_C = 14A$
		—	2.21	—			$I_C = 7.8A, T_J = 150^\circ\text{C}$
$V_{GE(th)}$	Gate Threshold Voltage	3.0	—	6.0		$V_{CE} = V_{GE}, I_C = 250\mu A$	
$\Delta V_{GE(th)}/\Delta T_J$	Temperature Coeff. of Threshold Voltage	—	-10	—	mV/°C	$V_{CE} = V_{GE}, I_C = 250\mu A$	
g_{fe}	Forward Transconductance ^④	4.1	6.2	—	S	$V_{CE} = 100V, I_C = 7.8A$	
I_{CES}	Zero Gate Voltage Collector Current	—	—	250	μA	$V_{GE} = 0V, V_{CE} = 600V$	
		—	—	1400		$V_{GE} = 0V, V_{CE} = 600V, T_J = 150^\circ\text{C}$	
V_{FM}	Diode Forward Voltage Drop	—	1.5	1.8	V	$I_C = 4.0A$	
		—	1.4	1.7		$I_C = 4.0A, T_J = 150^\circ\text{C}$	
I_{GES}	Gate-to-Emitter Leakage Current	—	—	± 100	nA	$V_{GE} = \pm 20V$	

Switching Characteristics @ $T_J = 25^\circ\text{C}$ (unless otherwise specified)

	Parameter	Min.	Typ.	Max.	Units	Conditions
Q_g	Total Gate Charge (turn-on)	—	23	35	nC	$I_C = 7.8A$ $V_{CC} = 400V$ $V_{GE} = 15V$
Q_{ge}	Gate - Emitter Charge (turn-on)	—	4.0	6.0		
Q_{gc}	Gate - Collector Charge (turn-on)	—	9.6	14		
$t_{d(on)}$	Turn-On Delay Time	—	17	—	ns	$T_J = 25^\circ\text{C}$ $I_C = 7.8A, V_{CC} = 480V$ $V_{GE} = 15V, R_G = 75\Omega$ Energy losses include "tail" and diode reverse recovery.
t_r	Rise Time	—	20	—		
$t_{d(off)}$	Turn-Off Delay Time	—	160	240		
t_f	Fall Time	—	83	120		
E_{on}	Turn-On Switching Loss	—	0.24	—	mJ	$T_J = 150^\circ\text{C}$, $I_C = 7.8A, V_{CC} = 480V$ $V_{GE} = 15V, R_G = 75\Omega$ Energy losses include "tail" and diode reverse recovery.
E_{off}	Turn-Off Switching Loss	—	0.26	—		
E_{ts}	Total Switching Loss	—	0.50	0.63		
$t_{d(on)}$	Turn-On Delay Time	—	16	—	ns	$T_J = 150^\circ\text{C}$, $I_C = 7.8A, V_{CC} = 480V$ $V_{GE} = 15V, R_G = 75\Omega$ Energy losses include "tail" and diode reverse recovery.
t_r	Rise Time	—	21	—		
$t_{d(off)}$	Turn-Off Delay Time	—	180	—		
t_f	Fall Time	—	220	—		
E_{ts}	Total Switching Loss	—	0.76	—	mJ	
L_E	Internal Emitter Inductance	—	7.5	—	nH	Measured 5mm from package
C_{ies}	Input Capacitance	—	410	—	pF	$V_{GE} = 0V$ $V_{CC} = 30V$ $f = 1.0MHz$
C_{oes}	Output Capacitance	—	37	—		
C_{res}	Reverse Transfer Capacitance	—	5.3	—		
t_{rr}	Diode Reverse Recovery Time	—	28	42	ns	$T_J = 25^\circ\text{C}$
		—	38	57		$T_J = 125^\circ\text{C}$
I_{rr}	Diode Peak Reverse Recovery Current	—	2.9	5.2	A	$T_J = 25^\circ\text{C}$
		—	3.7	6.7		$T_J = 125^\circ\text{C}$
Q_{rr}	Diode Reverse Recovery Charge	—	40	60	nC	$T_J = 25^\circ\text{C}$
		—	70	110		$T_J = 125^\circ\text{C}$
$di_{(rec)M}/dt$	Diode Peak Rate of Fall of Recovery During t_b	—	280	—	A/ μs	$T_J = 25^\circ\text{C}$
		—	240	—		$T_J = 125^\circ\text{C}$

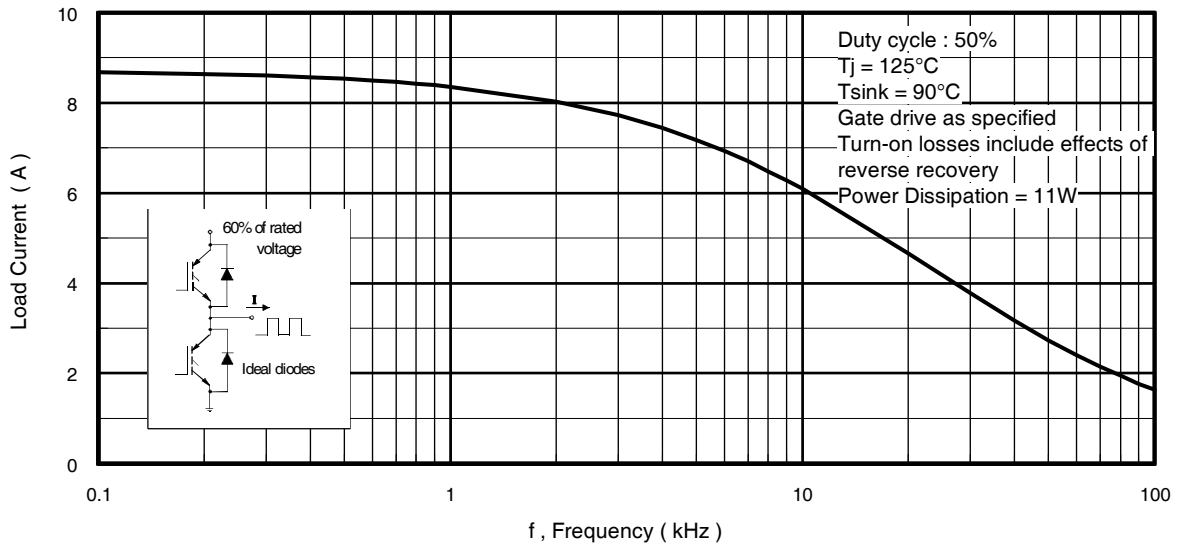

Fig. 1 - Typical Load Current vs. Frequency
 (Load Current = I_{RMS} of fundamental)

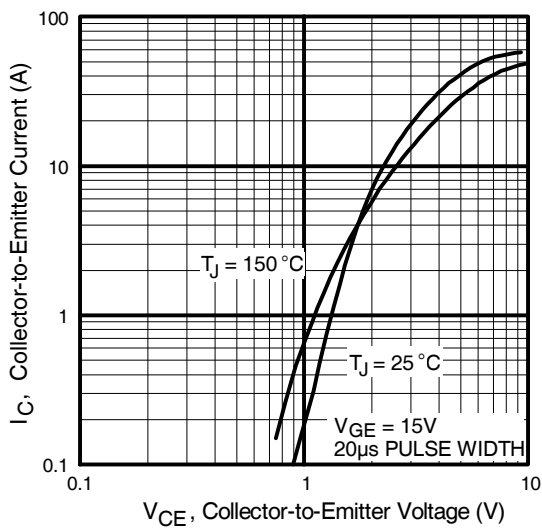

Fig. 2 - Typical Output Characteristics

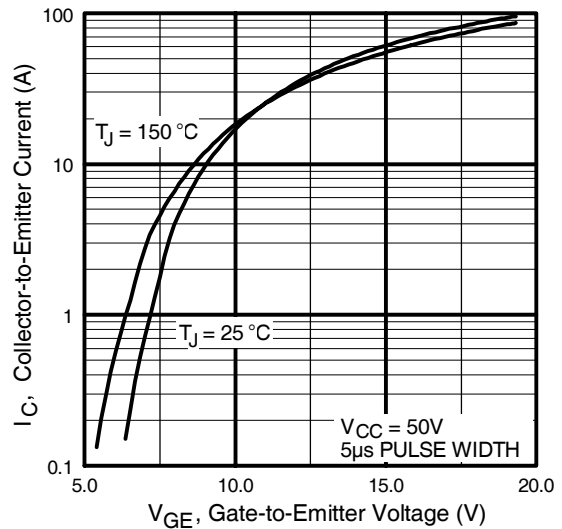

Fig. 3 - Typical Transfer Characteristics

IRG4BC15UDPbF

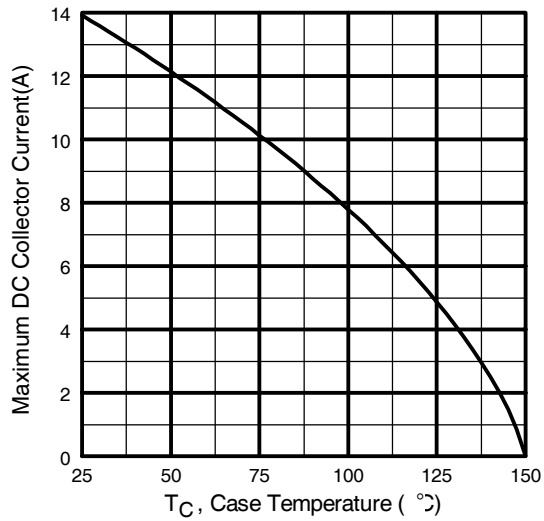

Fig. 4 - Maximum Collector Current vs. Case Temperature

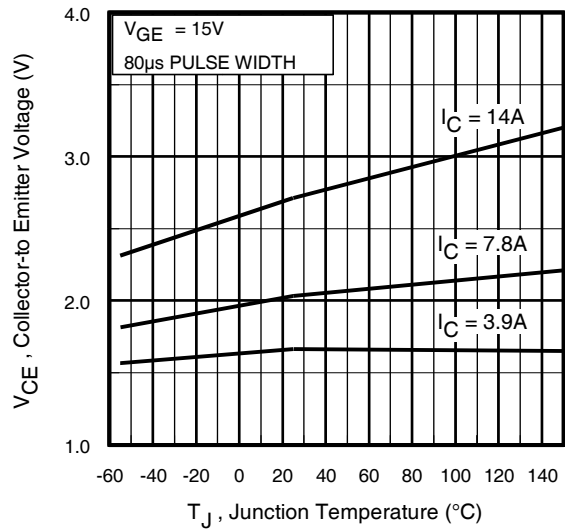

Fig. 5 - Typical Collector-to-Emitter Voltage vs. Junction Temperature

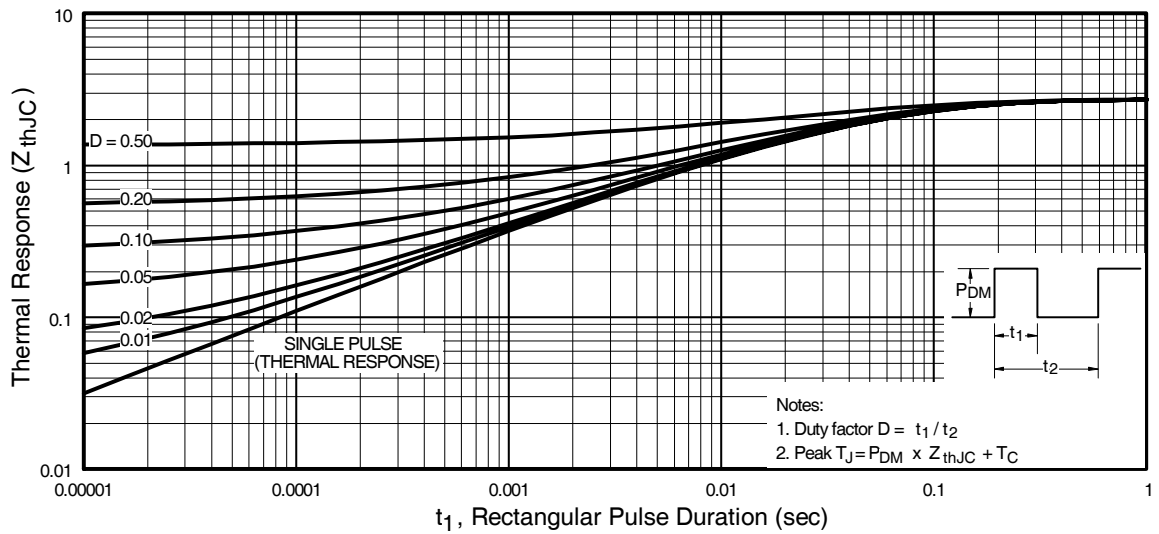

Fig. 6 - Maximum Effective Transient Thermal Impedance, Junction-to-Case

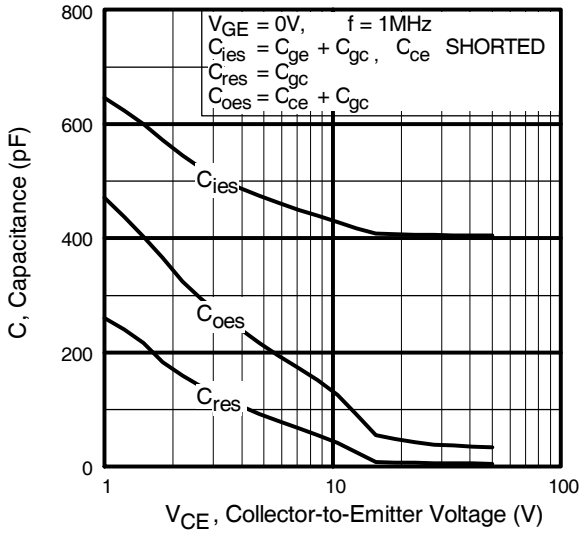

Fig. 7 - Typical Capacitance vs. Collector-to-Emitter Voltage

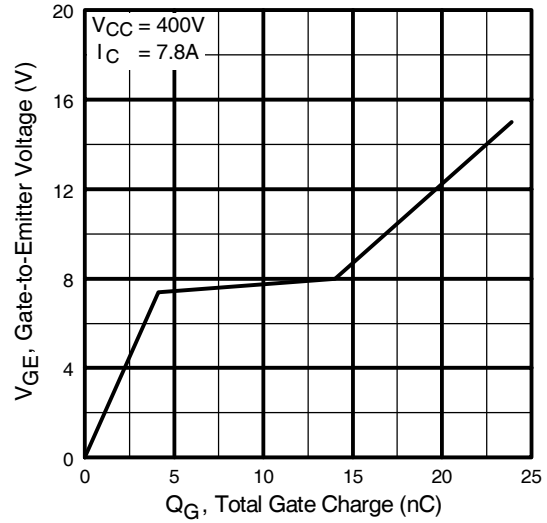

Fig. 8 - Typical Gate Charge vs. Gate-to-Emitter Voltage

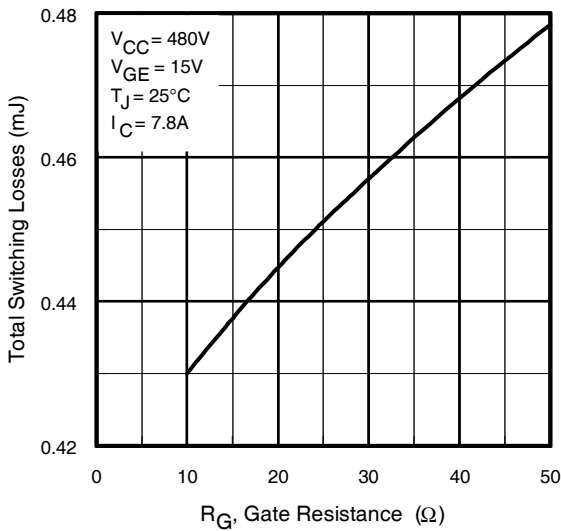

Fig. 9 - Typical Switching Losses vs. Gate Resistance

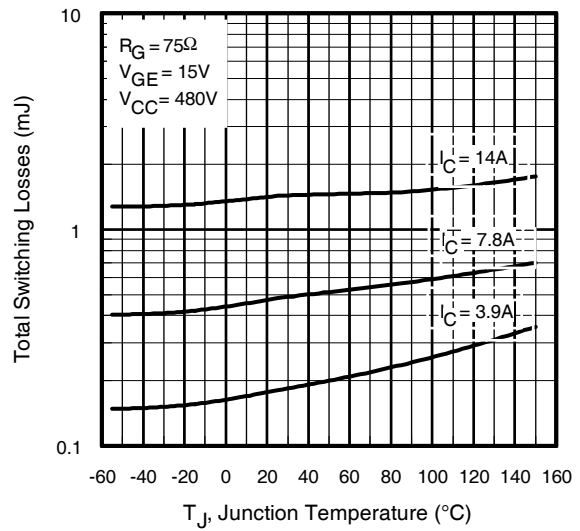

Fig. 10 - Typical Switching Losses vs. Junction Temperature

IRG4BC15UDPbF

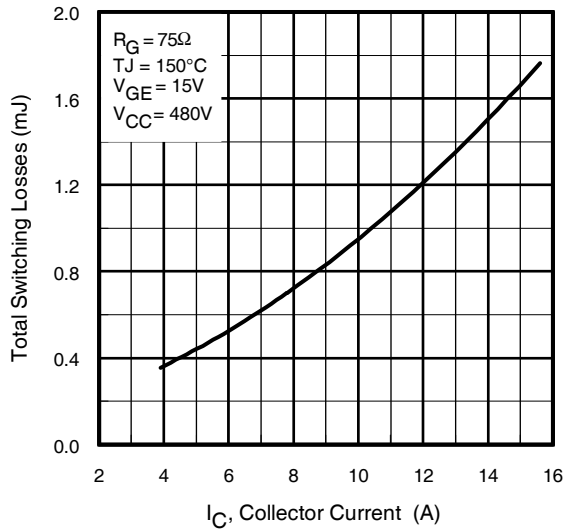

Fig. 11 - Typical Switching Losses vs. Collector-to-Emitter Current

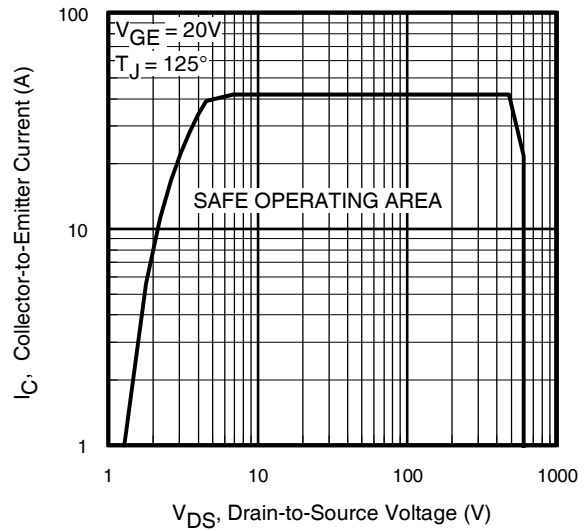

Fig. 12 - Turn-Off SOA

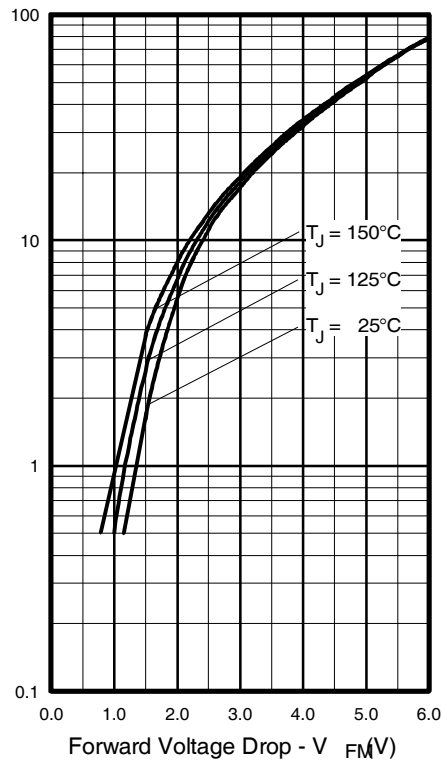

Fig. 13 - Maximum Forward Voltage Drop vs. Instantaneous Forward Current

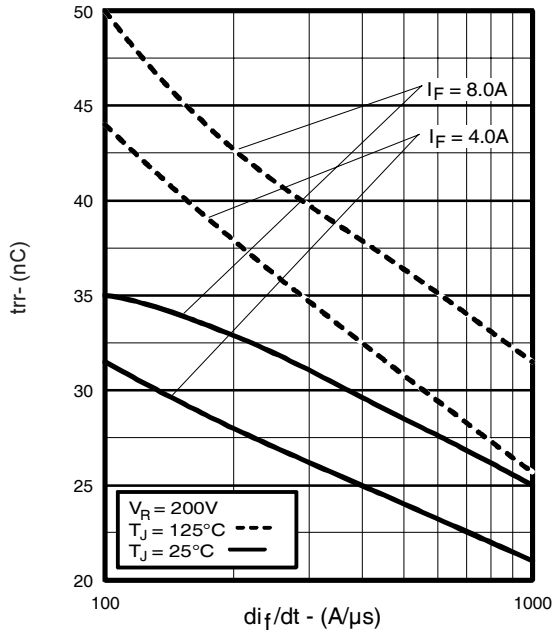

Fig. 14 - Typical Reverse Recovery vs. di_f/dt

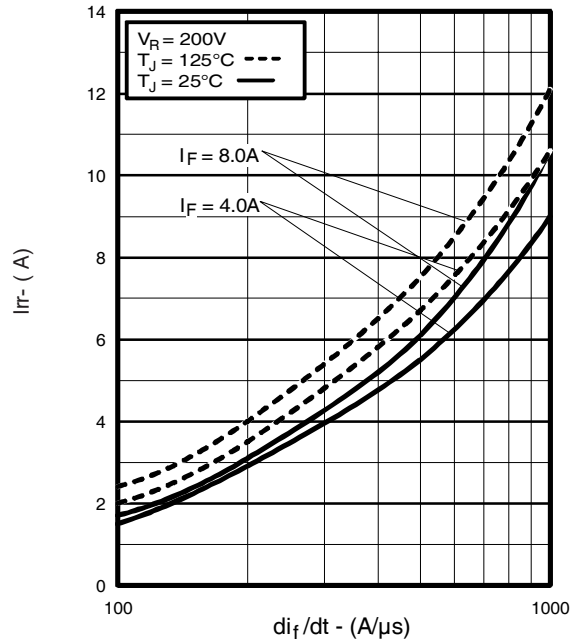

Fig. 15 - Typical Recovery Current vs. di_f/dt

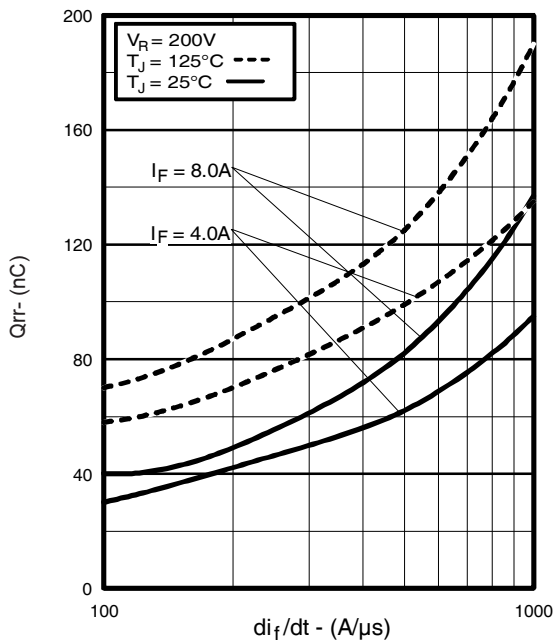

Fig. 16 - Typical Stored Charge vs. di_f/dt

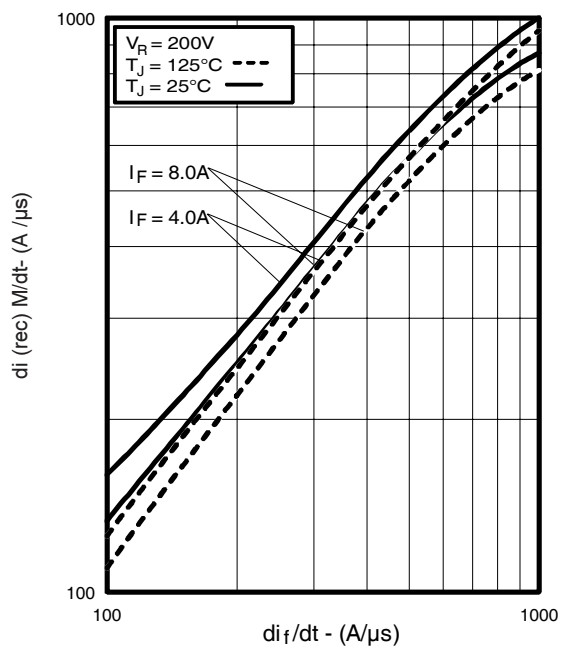

Fig. 17 - Typical $di_{(rec)M}/dt$ vs. di_f/dt ,

IRG4BC15UDPbF

International
IR Rectifier

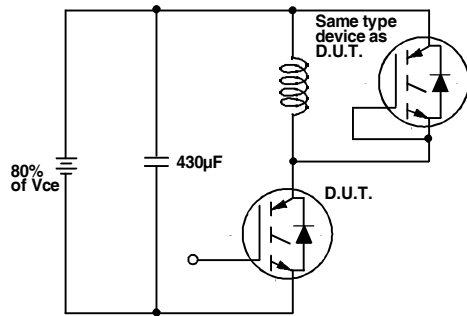

Fig. 18a - Test Circuit for Measurement of I_{LM} , E_{on} , $E_{off}(\text{diode})$, t_{rr} , Q_{rr} , I_{rr} , $t_{d(on)}$, t_r , $t_{d(off)}$, t_f

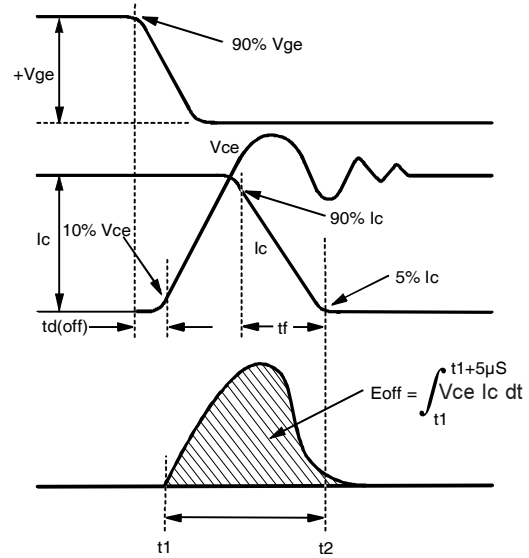

Fig. 18b - Test Waveforms for Circuit of Fig. 18a, Defining E_{off} , $t_{d(off)}$, t_f

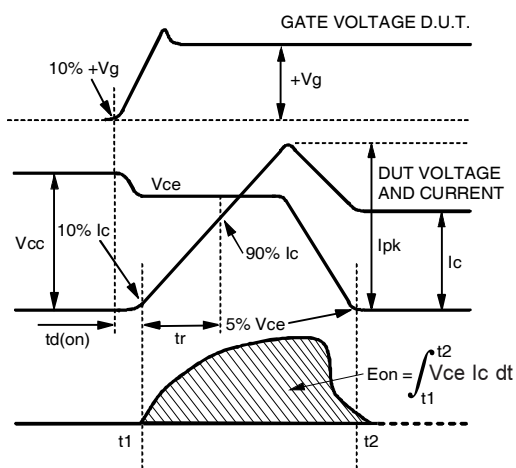

Fig. 18c - Test Waveforms for Circuit of Fig. 18a, Defining E_{on} , $t_{d(on)}$, t_r

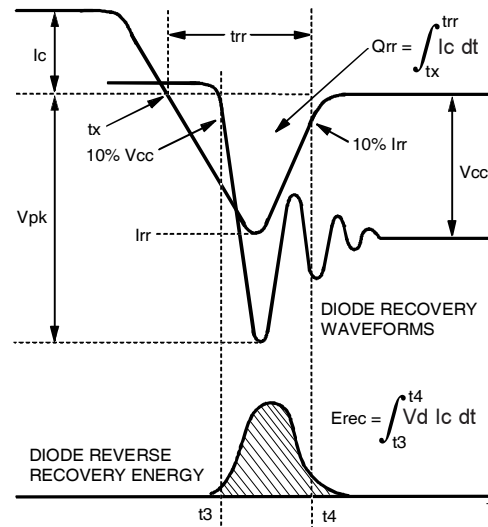

Fig. 18d - Test Waveforms for Circuit of Fig. 18a, Defining E_{rec} , t_{rr} , Q_{rr} , I_{rr}

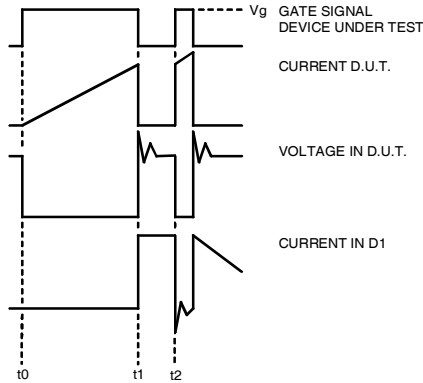

Figure 18e. Macro Waveforms for Figure 18a's Test Circuit

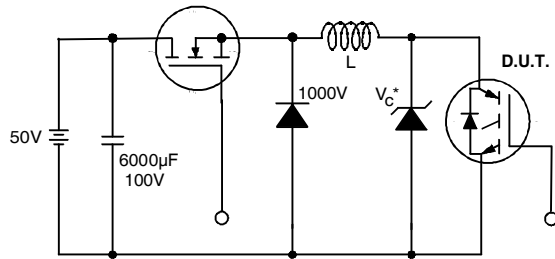

Figure 19. Clamped Inductive Load Test Circuit

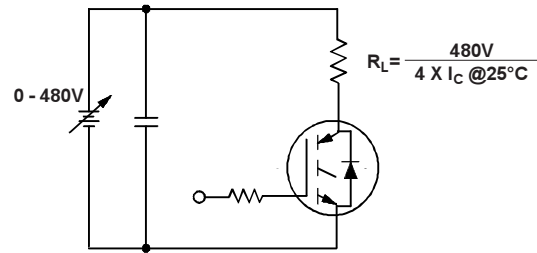

Figure 20. Pulsed Collector Current Test Circuit

IRG4BC15UDPbF

International
IR Rectifier

Notes:

- ① Repetitive rating: $V_{GE}=20V$; pulse width limited by maximum junction temperature
- ② $V_{CC}=80\%(V_{CES})$, $V_{GE}=20V$, $L=10\mu H$, $R_G = 75\Omega$
- ③ Pulse width $\leq 80\mu s$; duty factor $\leq 0.1\%$.
- ④ Pulse width $5.0\mu s$, single shot.

TO-220AB Package Outline

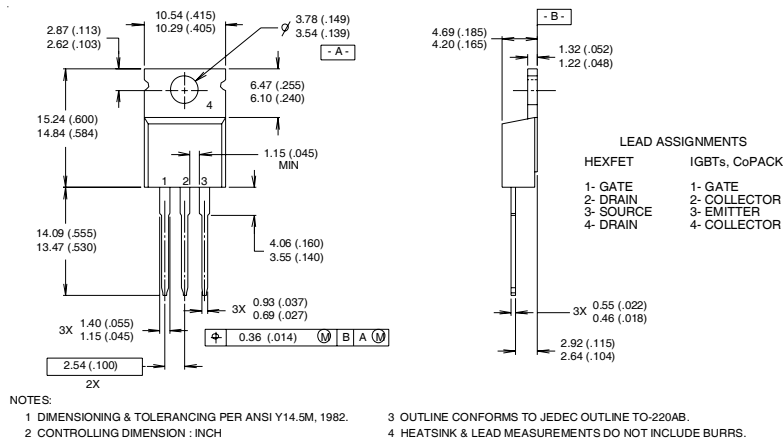

TO-220AB Part Marking Information

EXAMPLE: THIS IS AN IRF1010
 LOT CODE 1789
 ASSEMBLED ON WW 19, 1997
 IN THE ASSEMBLY LINE "C"
Note: "P" in assembly line
 position indicates "Lead-Free"

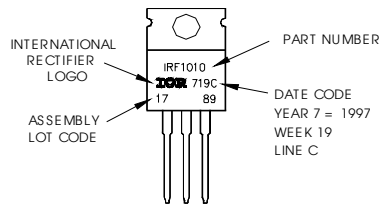

Data and specifications subject to change without notice.
 This product has been designed and qualified for the industrial market.
 Qualification Standards can be found on IR's Web site.

International
IR Rectifier

IR WORLD HEADQUARTERS: 233 Kansas St., El Segundo, California 90245, USA Tel: (310) 252-7105
 TAC Fax: (310) 252-7903
 Visit us at www.irf.com for sales contact information.08/04

Note: For the most current drawings please refer to the IR website at:
<http://www.irf.com/package/>

Looking for pricing, stock, or lifecycle information?

Click below to explore more details on WIN SOURCE:

 [View IRG4BC15UDPBF on WIN SOURCE](#)

 [Infineon Technologies](#) Information

Optimize Your Supply Chain with WIN SOURCE Solutions

-  Global Sourcing Solution
-  Obsolete Management
-  Cost Control Management
-  Shortage Management
-  Alternative Solution
-  Excess Inventory Management