



**THE DATASHEET OF  
ISL85415AIRZ**



# Wide $V_{IN}$ 500mA Synchronous Buck Regulator

## ISL85415A

The ISL85415A is a 500mA Synchronous buck regulator with an input range of 3V to 36V. It provides an easy to use, high efficiency low BOM count solution for a variety of applications.

The ISL85415A integrates both high-side and low-side NMOS FET's and features a PFM mode for improved efficiency at light loads. This feature can be disabled if forced PWM mode is desired. The part switches at a default frequency of 500kHz but may also be programmed using an external resistor from 300kHz to 2MHz. The ISL85415A has the ability to utilize internal or external compensation. By integrating both NMOS devices and providing internal configuration options, minimal external components are required, reducing BOM count and complexity of design.

With the wide  $V_{IN}$  range and reduced BOM the part provides an easy to implement design solution for a variety of applications while giving superior performance. It will provide a very robust design for high voltage Industrial applications as well as an efficient solution for battery powered applications.

The part is available in a small Pb free 4mmx3mm DFN plastic package with an operation temperature range of  $-40^{\circ}\text{C}$  to  $+85^{\circ}\text{C}$

## Related Literature

- See [AN1859](#), "ISL85415AEVAL1Z Wide  $V_{IN}$  500mA Synchronous Buck Regulator"

## Features

- Wide input voltage range 3V to 36V
- Synchronous operation for high efficiency
- No compensation required
- Integrated High-side and Low-side NMOS devices
- Selectable PFM or forced PWM mode at light loads
- Internal fixed (500kHz) or adjustable switching frequency 300kHz to 2MHz
- Continuous output current up to 500mA
- Internal or external soft-start
- Minimal external components required
- Power-good and enable functions available.

## Applications

- Industrial control
- Medical devices
- Portable instrumentation
- Distributed power supplies
- Cloud Infrastructure

TABLE 1. KEY DIFFERENCES BETWEEN PARTS

PART NUMBER	TEMP RANGE ( $^{\circ}\text{C}$ )	EN THRESHOLD	PG DELAY
ISL85415	$-40^{\circ}\text{C}$ to $+125^{\circ}\text{C}$	Standard TTL input	10% of soft-start time
ISL85415A	$-40^{\circ}\text{C}$ to $+85^{\circ}\text{C}$	High accuracy	2ms

NOTE: See Electrical specifications for more details on the ISL85415A.

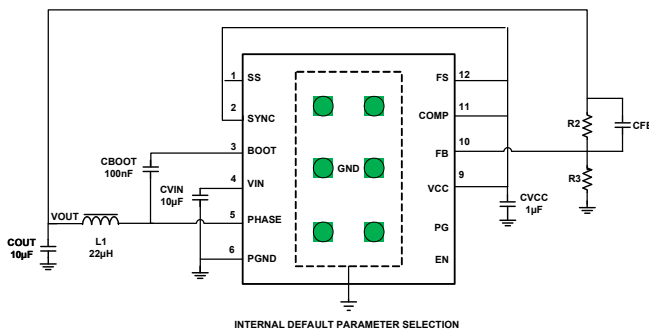

FIGURE 1. TYPICAL APPLICATION

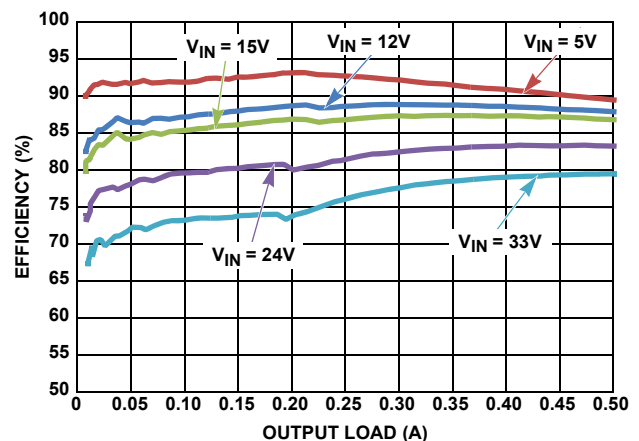

FIGURE 2. EFFICIENCY vs LOAD, PFM,  $V_{OUT} = 3.3\text{V}$

## Table of Contents

<b>Typical Application Schematics</b> .....	<b>4</b>
<b>Absolute Maximum Ratings</b> .....	<b>6</b>
<b>Thermal Information</b> .....	<b>6</b>
<b>Recommended Operating Conditions</b> .....	<b>6</b>
<b>Electrical Specifications</b> .....	<b>6</b>
<b>Efficiency Curves</b> .....	<b>8</b>
<b>Efficiency Curves</b> .....	<b>10</b>
<b>Typical Performance Curves</b> .....	<b>12</b>
<b>Detailed Description</b> .....	<b>17</b>
Power-On Reset .....	17
Soft-Start .....	17
Power-Good .....	17
PWM Control Scheme .....	17
Light Load Operation .....	18
Output Voltage Selection .....	18
<b>Protection Features</b> .....	<b>18</b>
Overcurrent Protection .....	19
Negative Current Limit .....	19
Over-Temperature Protection .....	19
Boot Undervoltage Protection .....	19
<b>Application Guidelines</b> .....	<b>19</b>
Simplifying the Design .....	19
Operating Frequency .....	19
Synchronization Control .....	19
Output Inductor Selection .....	19
Buck Regulator Output Capacitor Selection .....	20
Loop Compensation Design .....	20
Layout Considerations .....	21
<b>Revision History</b> .....	<b>23</b>
<b>About Intersil</b> .....	<b>23</b>
<b>Package Outline Drawing</b> .....	<b>24</b>

# ISL85415A

## Pin Configuration

ISL85415A  
(12 LD 4X3 DFN)  
TOP VIEW

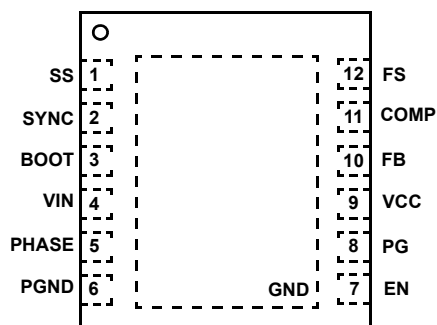

## Pin Descriptions

PIN NUMBER	SYMBOL	PIN DESCRIPTION
1	SS	The SS pin controls the soft-start ramp time of the output. A single capacitor from the SS pin to ground determines the output ramp rate. See the “Application Guidelines” on page 19 for soft-start details. If the SS pin is tied to VCC, an internal soft-start of 2ms will be used.
2	SYNC	Synchronization and light load operational mode selection input. Connect to logic high or VCC for PWM mode. Connect to logic low or ground for PFM mode. Connect to an external clock source for synchronization with positive edge trigger. Sync source must be higher than the programmed IC frequency. There is an internal 1M $\Omega$ pull-down resistor to prevent an undefined logic state if SYNC is left floating.
3	BOOT	Floating bootstrap supply pin for the power MOSFET gate driver. The bootstrap capacitor provides the necessary charge to turn on the internal N-Channel MOSFET. Connect an external 100nF capacitor from this pin to PHASE.
4	VIN	The input supply for the power stage of the regulator and the source for the internal linear bias regulator. Place a minimum of 4.7 $\mu$ F ceramic capacitance from VIN to GND and close to the IC for decoupling.
5	PHASE	Switch node output. It connects the switching FET's with the external output inductor.
6	PGND	Power ground connection. Connect directly to the system GND plane.
7	EN	Regulator enable input. The regulator and bias LDO are held off when the pin is pulled to ground. When the voltage on this pin rises above 1V, the chip is enabled. Connect this pin to VIN for automatic start-up. Do not connect EN pin to VCC since the LDO is controlled by EN voltage.
8	PG	Open drain power-good output that is pulled to ground when the output voltage is below regulation limits or during the soft-start interval. There is an internal 5M $\Omega$ internal pull-up resistor.
9	VCC	Output of the internal 5V linear bias regulator. Decouple to PGND with a 1 $\mu$ F ceramic capacitor at the pin.
10	FB	Feedback pin for the regulator. FB is the inverting input to the voltage loop error amplifier. COMP is the output of the error amplifier. The output voltage is set by an external resistor divider connected to FB. In addition, the PWM regulator's power-good and UVLO circuits use FB to monitor the regulator output voltage.
11	COMP	COMP is the output of the error amplifier. When it is tied to VCC, internal compensation is used. When only an RC network is connected from COMP to GND, external compensation is used. See “Loop Compensation Design” on page 20 for more details.
12	FS	Frequency selection pin. Tie to VCC for 500kHz switching frequency. Connect a resistor to GND for adjustable frequency from 300kHz to 2MHz.
EPAD	GND	Signal ground connections. Connect to application board GND plane with at least 5 vias. All voltage levels are measured with respect to this pin. The EPAD MUST not float.

## Typical Application Schematics

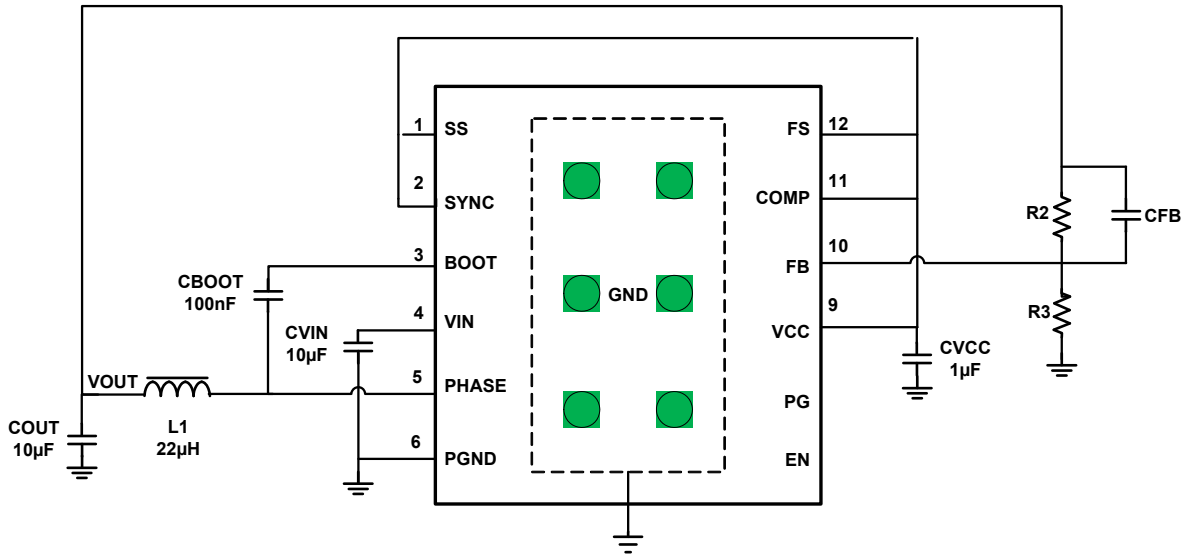

FIGURE 3. INTERNAL DEFAULT PARAMETER SELECTION

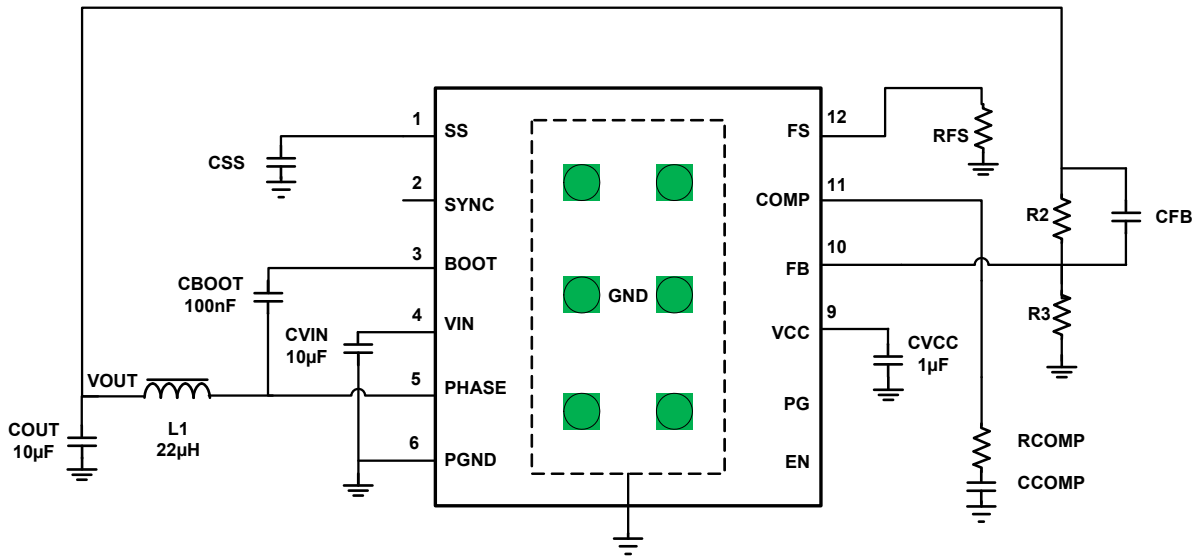
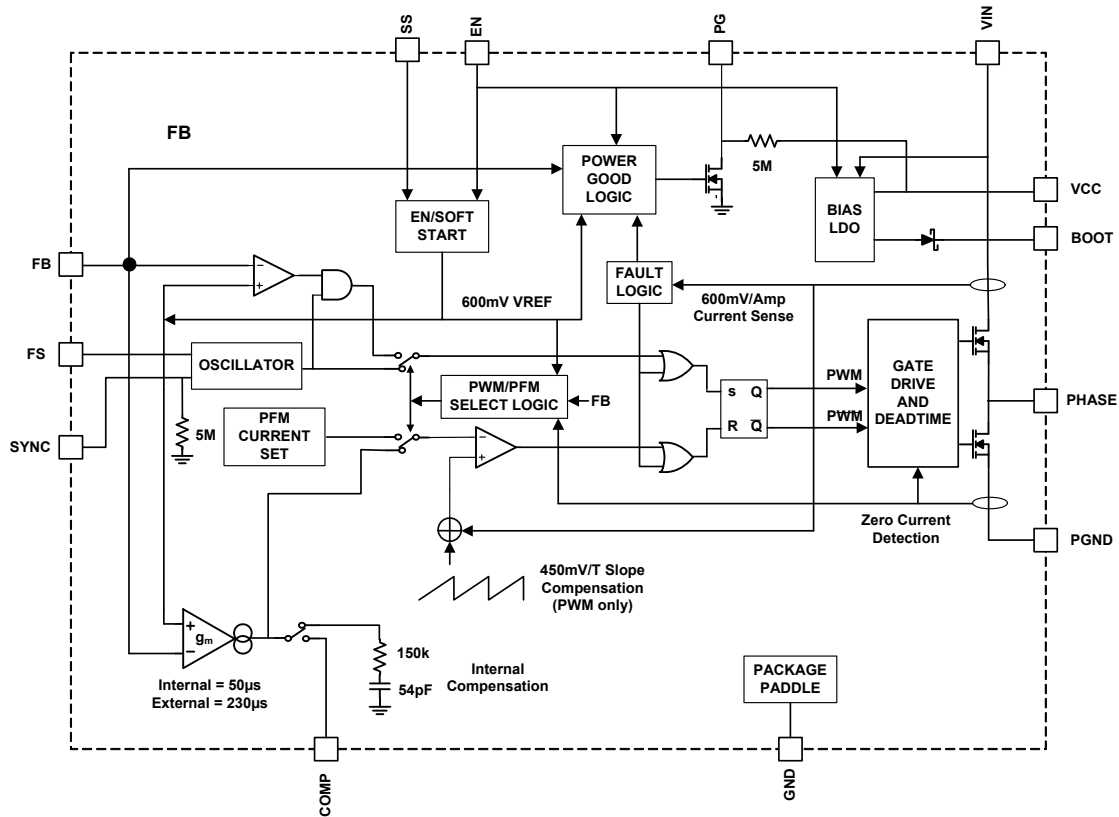

FIGURE 4. USER PROGRAMMABLE PARAMETER SELECTION

TABLE 2. EXTERNAL COMPONENT SELECTION

V <sub>OUT</sub> (V)	L <sub>1</sub> (µH)	C <sub>OUT</sub> (µF)	R <sub>2</sub> (kΩ)	R <sub>3</sub> (kΩ)	C <sub>FB</sub> (pF)	R <sub>FS</sub> (kΩ)	R <sub>COMP</sub> (kΩ)	C <sub>COMP</sub> (pF)
12	45	10	90.9	4.75	22	115	100	470
5	22	2x22	90.9	12.4	100	120	100	470
3.3	22	2x22	90.9	20	100	120	100	470
2.5	22	2x22	90.9	28.7	100	120	100	470
1.8	22	22	100	50	22	120	50	470

## Functional Block Diagram



## Ordering Information

PART NUMBER (Notes 1, 2, 3)	PART MARKING	TEMP. RANGE (°C)	PACKAGE (Pb-Free)	PKG. DWG. #
ISL85415AIRZ	415A	-40 to +85	12 Ld DFN	L12.4x3
ISL85415AEVAL1Z	Evaluation Board			

### NOTES:

1. Add "T" suffix for Tape and Reel. Please refer to [TB347](#) for details on reel specifications.
2. These Intersil Pb-free plastic packaged products employ special Pb-free material sets, molding compounds/die attach materials, and 100% matte tin plate plus anneal (e3 termination finish, which is RoHS compliant and compatible with both SnPb and Pb-free soldering operations). Intersil Pb-free products are MSL classified at Pb-free peak reflow temperatures that meet or exceed the Pb-free requirements of IPC/JEDEC J STD-020.
3. For Moisture Sensitivity Level (MSL), please see device information page for [ISL85415A](#). For more information on MSL please see techbrief [TB363](#).

# ISL85415A

## Absolute Maximum Ratings

VIN to GND	-0.3V to +42V
PHASE to GND	-0.3V to VIN+0.3V (DC)
PHASE to GND	-2V to 43V (20ns)
EN to GND	-0.3V to +42V
BOOT to PHASE	-0.3V to +5.5V
COMP, FS, PG, SYNC, SS, VCC to GND	-0.3V to +5.9V
FB to GND	-0.3V to +2.95V
ESD Rating	
Human Body Model (Tested per JESD22-A114)	3kV
Charged Device Model (Tested per JESD22-C101E)	1.5kV
Machine Model (Tested per JESD22-A115)	200V
Latch Up (Tested per JESD-78A; Class 2, Level A)	100mA

## Thermal Information

Thermal Resistance	$\theta_{JA}$ (°C/W)	$\theta_{JC}$ (°C/W)
DFN Package (Notes 4, 5)	44	5.5
Maximum Junction Temperature (Plastic Package)	+150°C	
Maximum Storage Temperature Range	-65°C to +150°C	
Ambient Temperature Range	-40°C to +85°C	
Operating Junction Temperature Range	-40°C to +85°C	
Pb-Free Reflow Profile	see link below	
	<a href="http://www.intersil.com/pbfree/Pb-FreeReflow.asp">http://www.intersil.com/pbfree/Pb-FreeReflow.asp</a>	

## Recommended Operating Conditions

Temperature	-40°C to +85°C
Supply Voltage	3V to 36V

**CAUTION:** Do not operate at or near the maximum ratings listed for extended periods of time. Exposure to such conditions may adversely impact product reliability and result in failures not covered by warranty.

### NOTES:

- $\theta_{JA}$  is measured in free air with the component mounted on a high effective thermal conductivity test board with "direct attach" features. See Tech Brief [TB379](#) for details.
- For  $\theta_{JC}$ , the "case temp" location is the center of the exposed metal pad on the package underside.

**Electrical Specifications**  $T_A = -40^\circ\text{C}$  to  $+85^\circ\text{C}$ ,  $V_{IN} = 3\text{V}$  to  $36\text{V}$ , unless otherwise noted. Typical values are at  $T_A = +25^\circ\text{C}$ . **Boldface limits apply over the junction temperature range,  $-40^\circ\text{C}$  to  $+85^\circ\text{C}$**

PARAMETER	SYMBOL	TEST CONDITIONS	MIN (Note 8)	TYP	MAX (Note 8)	UNITS
<b>SUPPLY VOLTAGE</b>						
VIN Voltage Range	VIN		<b>3</b>		<b>36</b>	V
VIN Quiescent Supply Current	IQ	VFB = 0.7V, SYNC = 0V, FS = VCC		90		µA
VIN Shutdown Supply Current	ISD	EN = 0V (Note 6)		10	<b>13</b>	µA
VCC Voltage	VCC	IOUT = 0mA	<b>4.8</b>	5.15	<b>5.5</b>	V
		VIN = 6V; IOUT = 10mA	<b>4.65</b>	5	<b>5.35</b>	V
<b>POWER-ON RESET</b>						
VCC POR Threshold		Rising Edge		2.75	<b>2.95</b>	V
		Falling Edge	<b>2.4</b>	2.6		V
<b>OSCILLATOR</b>						
Nominal Switching Frequency	FS	FS = VCC	<b>440</b>	500	<b>560</b>	kHz
		Resistor from FS to GND = 340kΩ	<b>240</b>	300	<b>360</b>	kHz
		Resistor from FS to GND = 32.4kΩ		2000		kHz
Minimum Off-Time	tOFF	VIN = 3V		150		ns
Minimum On-Time	tON			90		ns
FS Voltage	VFS	FS = 100kΩ	<b>0.39</b>	0.4	<b>0.41</b>	V
Synchronization Frequency	SYNC		<b>300</b>		<b>2000</b>	kHz
SYNC Pulse Width				100		ns
<b>ERROR AMPLIFIER</b>						
Error Amplifier Transconductance Gain	gm	External Compensation	<b>165</b>	230	<b>295</b>	µA/V
		Internal Compensation		50		µA/V
FB Leakage Current		VFB = 0.6V		1	<b>100</b>	nA
Current Sense Amplifier Gain	RT		<b>0.54</b>	0.6	<b>0.66</b>	V/A
FB Voltage			<b>0.589</b>	0.599	<b>0.606</b>	V

# ISL85415A

**Electrical Specifications**  $T_A = -40^\circ\text{C}$  to  $+85^\circ\text{C}$ ,  $V_{IN} = 3\text{V}$  to  $36\text{V}$ , unless otherwise noted. Typical values are at  $T_A = +25^\circ\text{C}$ . **Boldface limits apply over the junction temperature range,  $-40^\circ\text{C}$  to  $+85^\circ\text{C}$**  (Continued)

PARAMETER	SYMBOL	TEST CONDITIONS	MIN (Note 8)	TYP	MAX (Note 8)	UNITS
<b>POWER-GOOD</b>						
Lower PG Threshold - VFB Rising				90	<b>94</b>	%
Lower PG Threshold - VFB Falling			<b>82.5</b>	86		%
Upper PG Threshold - VFB Rising				116.5	<b>120</b>	%
Upper PG Threshold - VFB Falling			<b>107</b>	112		%
PG Propagation Delay		PG delay measured after $V_{OUT}$ reaches regulation	<b>1.1</b>	2	<b>2.9</b>	ms
PG Low Voltage		$I_{SINK} = 3\text{mA}$ , $EN = V_{CC}$ , $V_{FB} = 0\text{V}$		0.05	<b>0.3</b>	V
PG Low Voltage without $V_{IN}$ present		$I_{SINK} = 0.5\text{mA}$ , $V_{IN} = 0\text{V}$		0.6	<b>0.8</b>	V
<b>TRACKING AND SOFT-START</b>						
Soft-Start Charging Current	$I_{SS}$		<b>1.5</b>	2	<b>2.5</b>	$\mu\text{A}$
Internal Soft-Start Ramp Time		$EN/SS = V_{CC}$	<b>1.7</b>	2.4	<b>3.1</b>	ms
<b>FAULT PROTECTION</b>						
Thermal Shutdown Temperature	$T_{SD}$	Rising Threshold		135		$^\circ\text{C}$
	$T_{HYS}$	Hysteresis		20		$^\circ\text{C}$
Current Limit Blanking Time	$t_{OCON}$			17		Clock pulses
Overcurrent and Auto Restart Period	$t_{OCCOFF}$			8		SS cycle
Positive Peak Current Limit	$I_{PLIMIT}$	(Note 7)	<b>0.8</b>	0.9	<b>1</b>	A
PFM Peak Current Limit	$I_{PK\_PFM}$		<b>0.26</b>	0.3	<b>0.34</b>	A
Zero Cross Threshold				10		mA
Negative Current Limit	$I_{NLIMIT}$	(Note 7)	<b>-0.46</b>	-0.40	<b>-0.34</b>	A
<b>POWER MOSFET</b>						
High-side	$R_{HDS}$	$I_{PHASE} = 100\text{mA}$ , $V_{CC} = 5\text{V}$		450	<b>600</b>	$\text{m}\Omega$
Low-side	$R_{LDS}$	$I_{PHASE} = 100\text{mA}$ , $V_{CC} = 5\text{V}$		250	<b>330</b>	$\text{m}\Omega$
PHASE Leakage Current		$EN = PHASE = 0\text{V}$			<b>300</b>	nA
PHASE Rise Time	$t_{RISE}$	$V_{IN} = 36\text{V}$		10		ns
<b>EN/SYNC</b>						
EN Input Threshold		Falling Edge, Logic Low	<b>0.818</b>	0.87	<b>0.922</b>	V
		Rising Edge, Logic High	<b>1.017</b>	1.07	<b>1.123</b>	V
SYNC Input Threshold		Falling Edge, Logic Low	<b>0.4</b>	1		V
		Rising Edge, Logic High		1.2	<b>1.4</b>	V
EN Logic Input Leakage Current		$EN = 0\text{V}/36\text{V}$	<b>-0.5</b>		<b>0.5</b>	$\mu\text{A}$
SYNC Logic Input Leakage Current		$SYNC = 0\text{V}$		10	<b>100</b>	nA
		$SYNC = 5\text{V}$		1.0	<b>1.3</b>	$\mu\text{A}$

**NOTES:**

6. Test Condition:  $V_{IN} = 36\text{V}$ , FB forced above regulation point (0.6V), no switching, and power MOSFET gate charging current not included.
7. Established by both current sense amplifier gain test and current sense amplifier output test @  $I_L = 0\text{A}$ .
8. Parameters with MIN and/or MAX limits are 100% tested at  $+25^\circ\text{C}$ , unless otherwise specified. Temperature limits established by characterization and are not production tested.

## Efficiency Curves $F_{SW} = 800kHz, T_A = +25^\circ C$

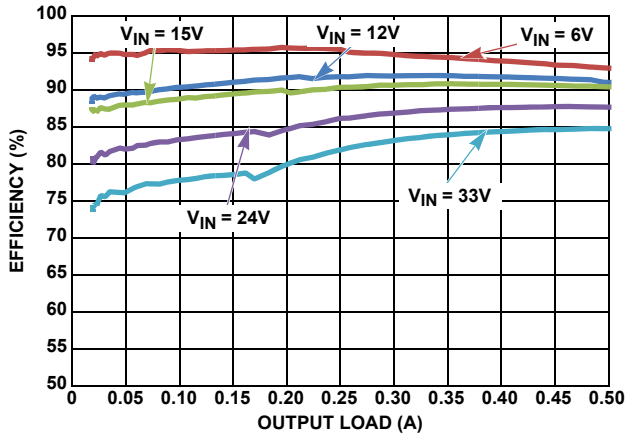

FIGURE 5. EFFICIENCY vs LOAD, PFM,  $V_{OUT} = 5V$

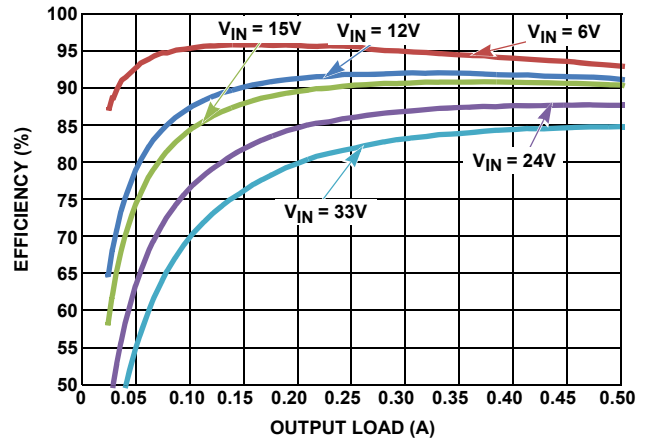

FIGURE 6. EFFICIENCY vs LOAD, PWM,  $V_{OUT} = 5V$

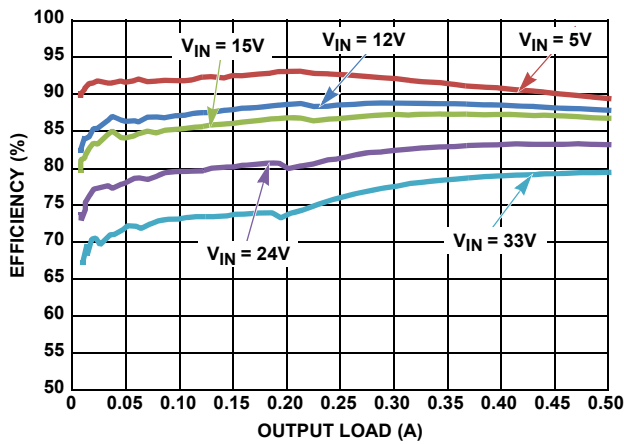

FIGURE 7. EFFICIENCY vs LOAD, PFM,  $V_{OUT} = 3.3V$

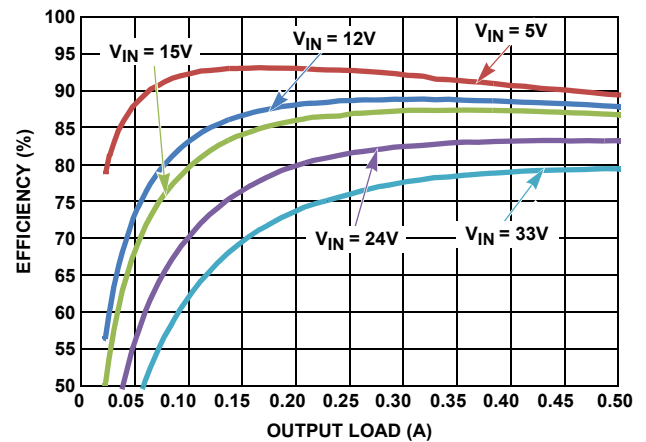

FIGURE 8. EFFICIENCY vs LOAD, PWM,  $V_{OUT} = 3.3V$

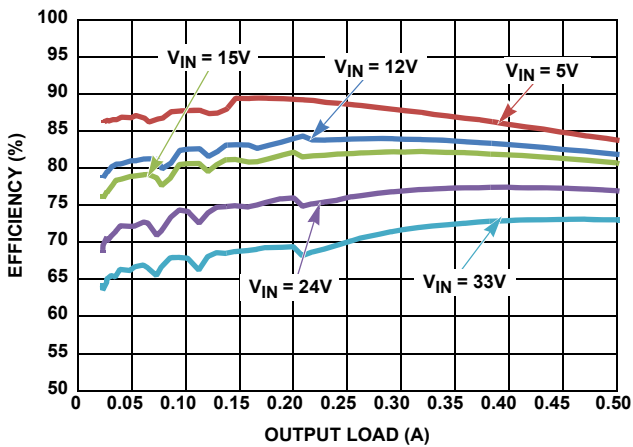

FIGURE 9. EFFICIENCY vs LOAD, PFM,  $V_{OUT} = 1.8V$

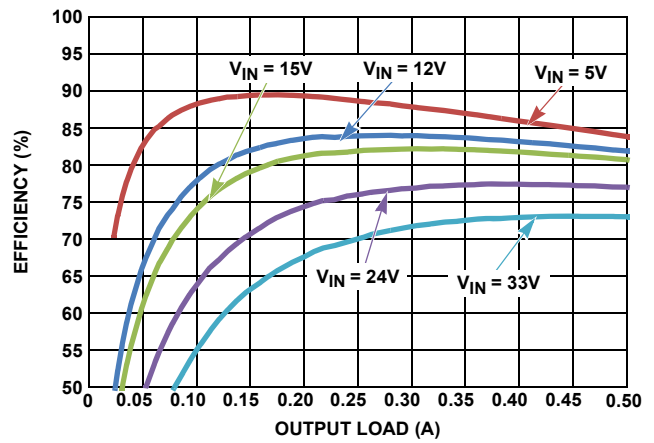

FIGURE 10. EFFICIENCY vs LOAD, PWM,  $V_{OUT} = 1.8V$

## Efficiency Curves $F_{SW} = 800\text{kHz}$ , $T_A = +25^\circ\text{C}$ (Continued)

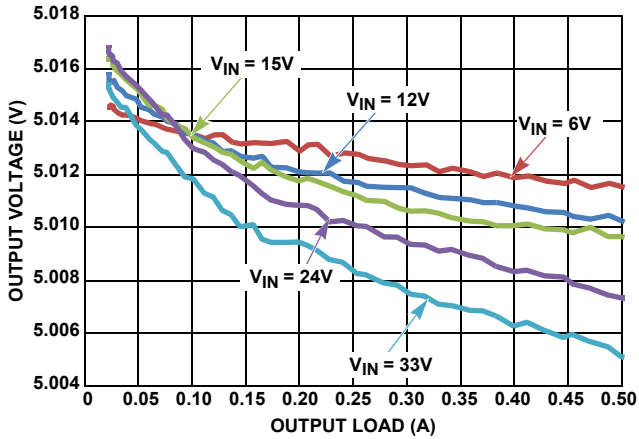

FIGURE 11.  $V_{OUT}$  REGULATION vs LOAD, PWM,  $V_{OUT} = 5\text{V}$

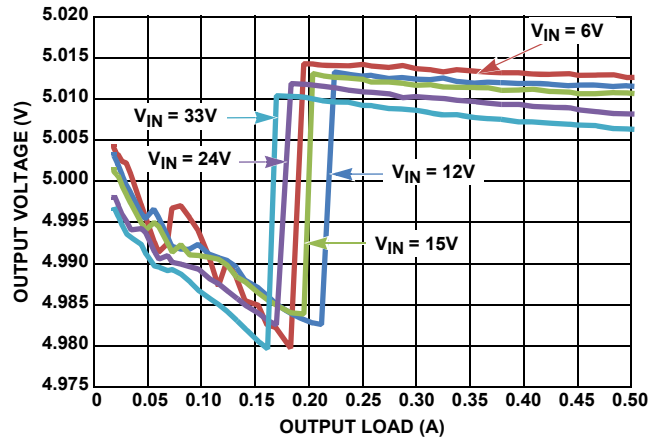

FIGURE 12.  $V_{OUT}$  REGULATION vs LOAD, PFM,  $V_{OUT} = 5\text{V}$

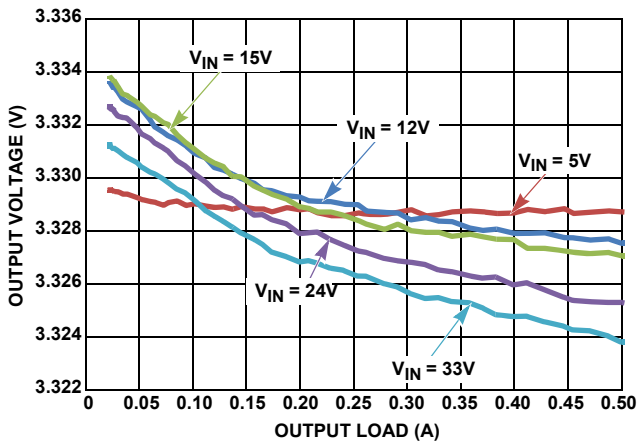

FIGURE 13.  $V_{OUT}$  REGULATION vs LOAD, PWM,  $V_{OUT} = 3.3\text{V}$

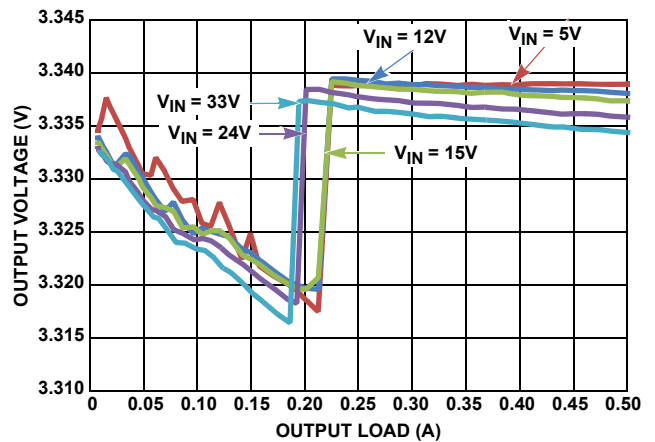

FIGURE 14.  $V_{OUT}$  REGULATION vs LOAD, PFM,  $V_{OUT} = 3.3\text{V}$

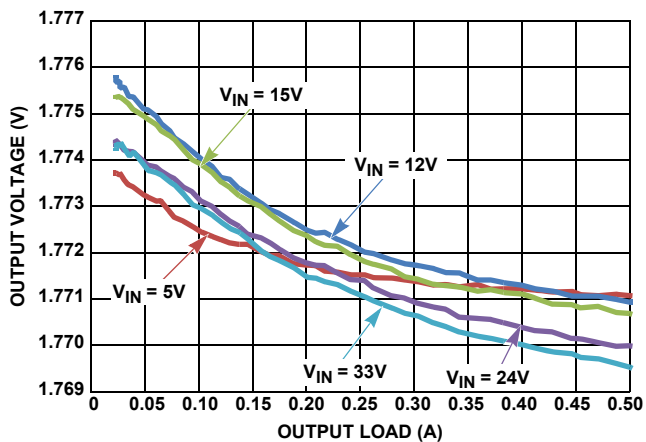

FIGURE 15.  $V_{OUT}$  REGULATION vs LOAD, PWM,  $V_{OUT} = 1.8\text{V}$

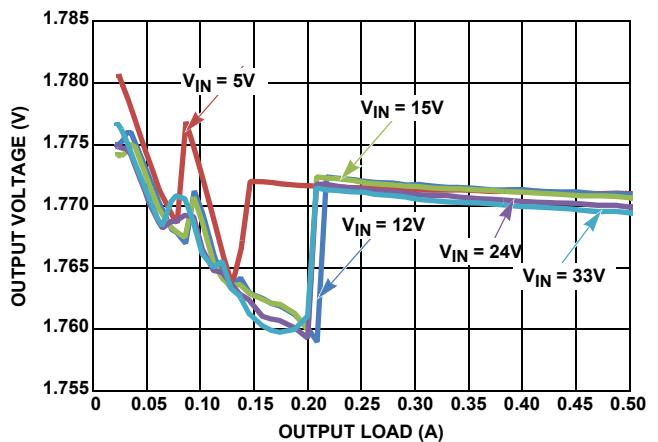

FIGURE 16.  $V_{OUT}$  REGULATION vs LOAD, PFM,  $V_{OUT} = 1.8\text{V}$

## Efficiency Curves $F_{SW} = 500kHz, T_A = +25^\circ C$

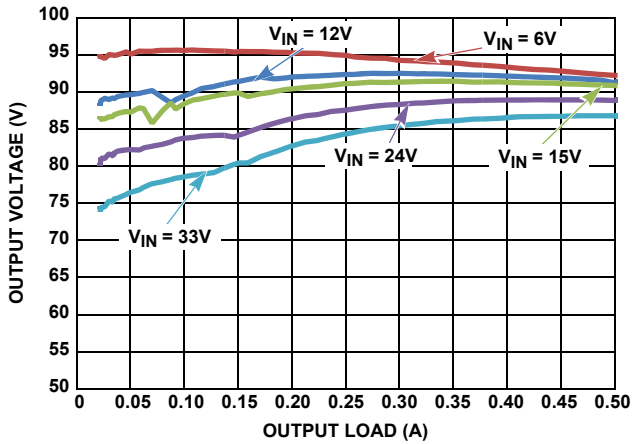

FIGURE 17. EFFICIENCY vs LOAD, PFM,  $V_{OUT} = 5V$

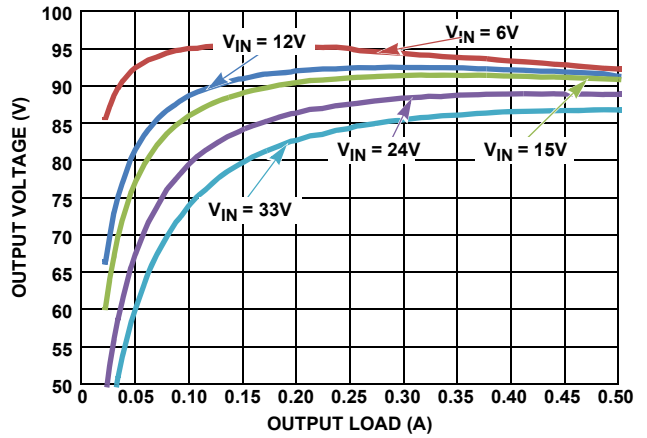

FIGURE 18. EFFICIENCY vs LOAD, PWM,  $V_{OUT} = 5V$

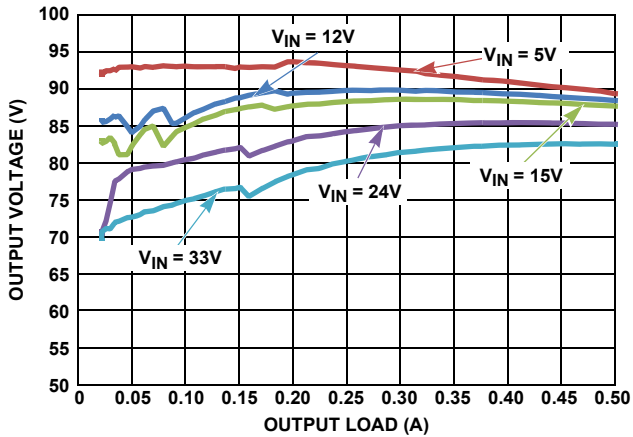

FIGURE 19. EFFICIENCY vs LOAD, PFM,  $V_{OUT} = 3.3V$

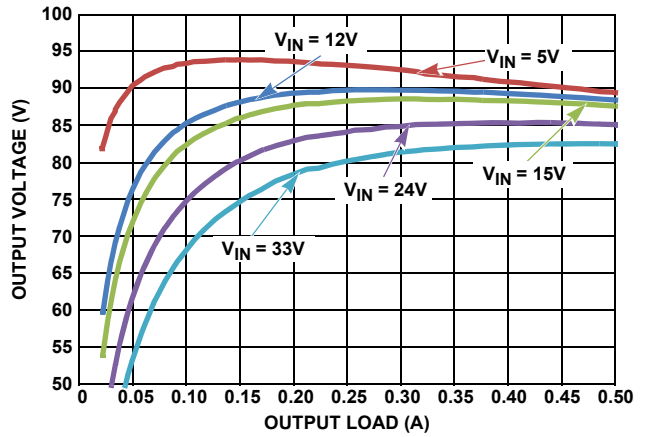

FIGURE 20. EFFICIENCY vs LOAD, PWM,  $V_{OUT} = 3.3V$

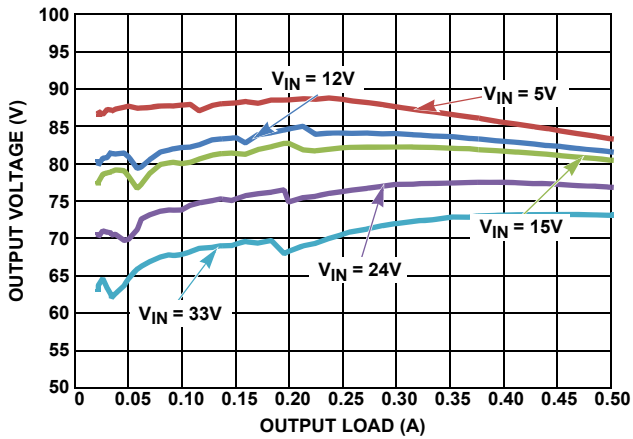

FIGURE 21. EFFICIENCY vs LOAD, PFM,  $V_{OUT} = 1.8V$

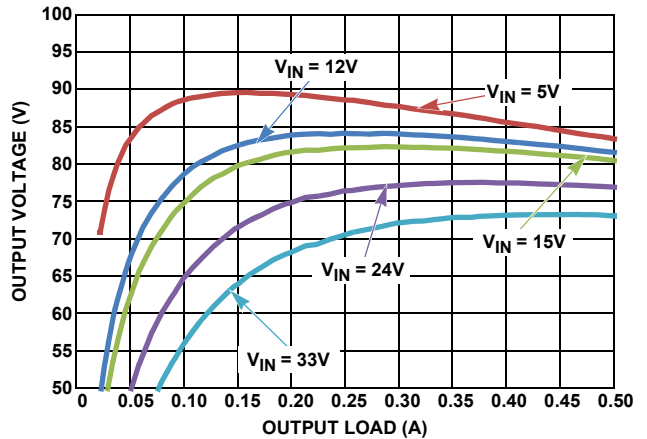

FIGURE 22. EFFICIENCY vs LOAD, PWM,  $V_{OUT} = 1.8V$

## Efficiency Curves $F_{SW} = 500\text{kHz}$ , $T_A = +25^\circ\text{C}$ (Continued)

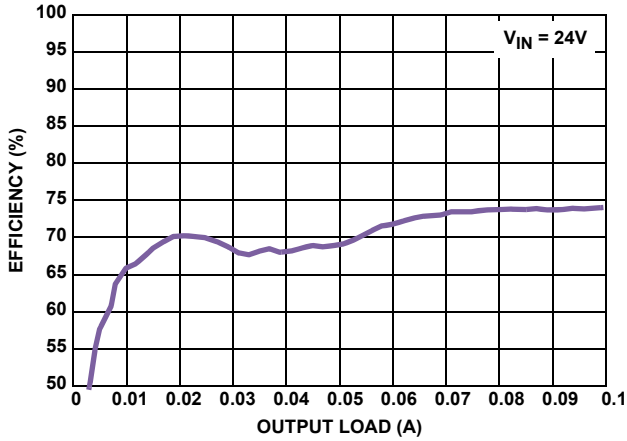

FIGURE 23. EFFICIENCY vs LOAD, PFM,  $V_{OUT} = 1.8\text{V}$

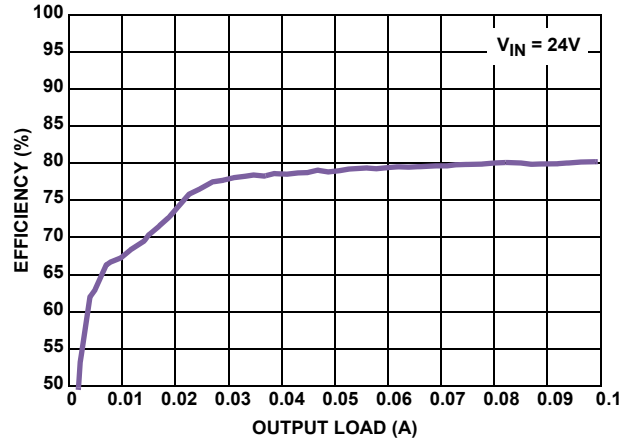

FIGURE 24. EFFICIENCY vs LOAD, PFM,  $V_{OUT} = 3.3\text{V}$

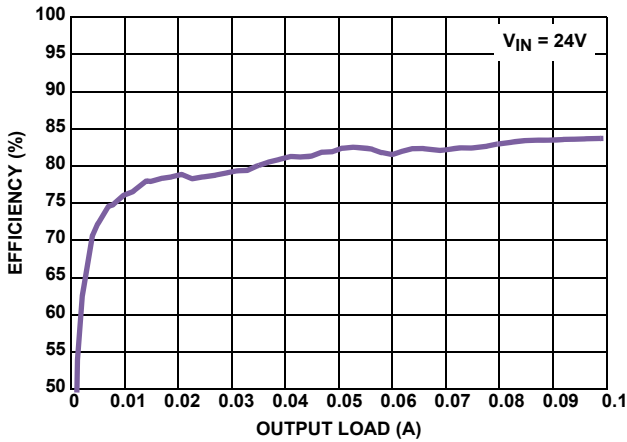

FIGURE 25. EFFICIENCY vs LOAD, PFM,  $V_{OUT} = 5\text{V}$

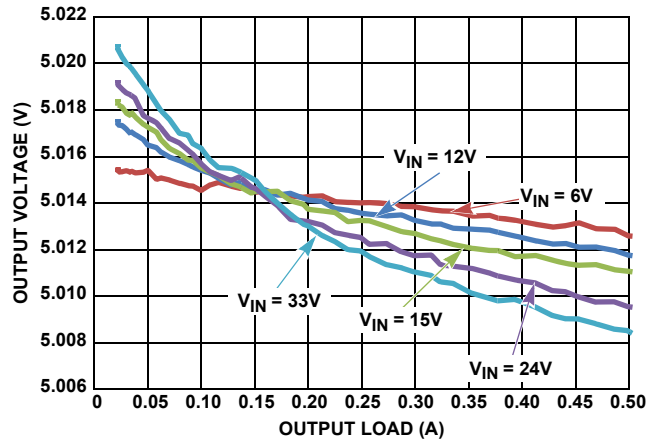

FIGURE 26.  $V_{OUT}$  REGULATION vs LOAD, PWM,  $V_{OUT} = 5\text{V}$

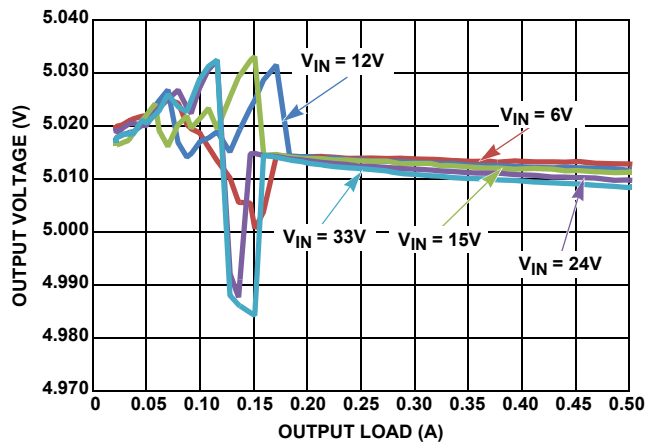

FIGURE 27.  $V_{OUT}$  REGULATION vs LOAD, PFM,  $V_{OUT} = 5\text{V}$

## Efficiency Curves $F_{SW} = 500\text{kHz}$ , $T_A = +25^\circ\text{C}$ (Continued)

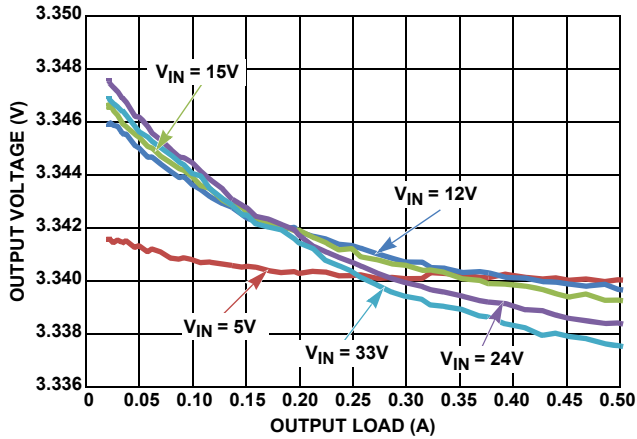

FIGURE 28.  $V_{OUT}$  REGULATION vs LOAD, PWM,  $V_{OUT} = 3.3\text{V}$

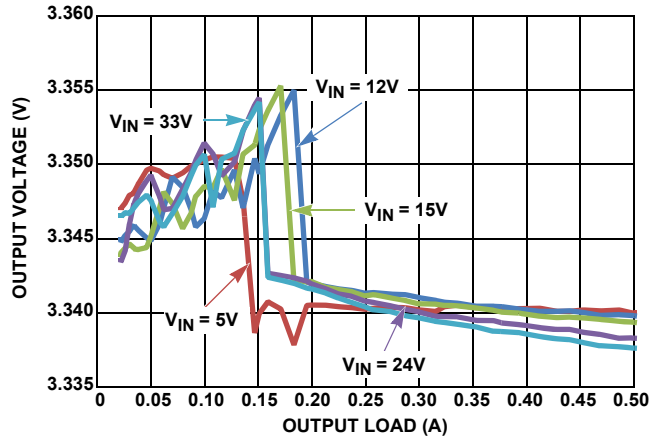

FIGURE 29.  $V_{OUT}$  REGULATION vs LOAD, PFM,  $V_{OUT} = 3.3\text{V}$

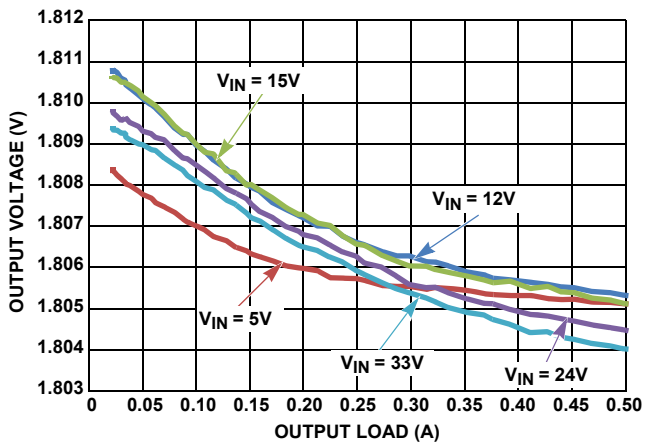

FIGURE 30.  $V_{OUT}$  REGULATION vs LOAD, PWM,  $V_{OUT} = 1.8\text{V}$

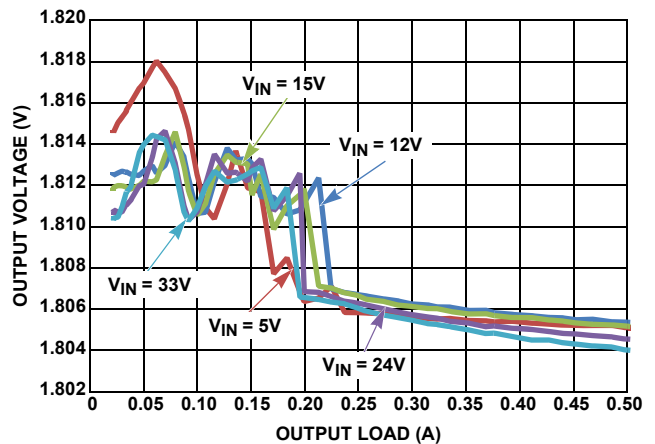

FIGURE 31.  $V_{OUT}$  REGULATION vs LOAD, PFM,  $V_{OUT} = 1.8\text{V}$

## Typical Performance Curves $V_{IN} = 24\text{V}$ , $V_{OUT} = 3.3\text{V}$ , $SS = V_{CC}$ , $F_{SW} = 800\text{kHz}$ , $T_A = +25^\circ\text{C}$ .

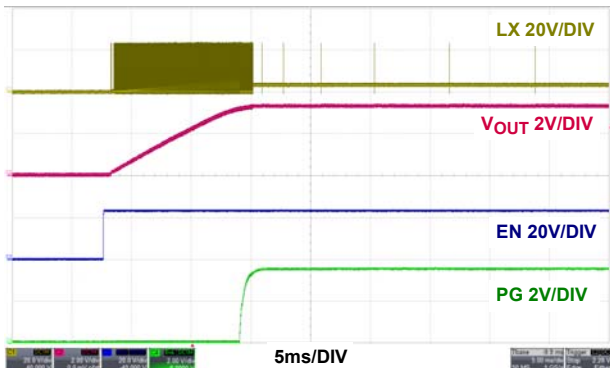

FIGURE 32. START-UP AT NO LOAD, PFM

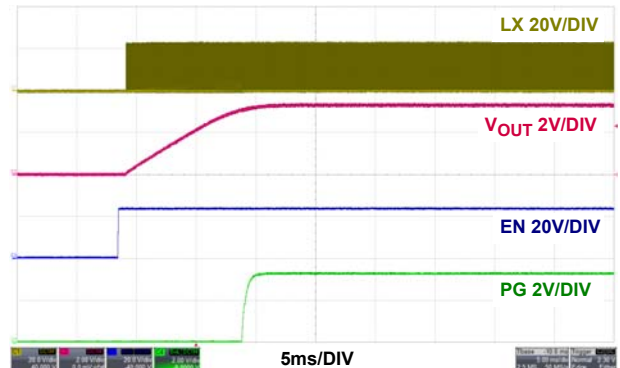

FIGURE 33. START-UP AT NO LOAD, PWM

## Typical Performance Curves $V_{IN} = 24V, V_{OUT} = 3.3V, SS = V_{CC}, F_{SW} = 800kHz, T_A = +25^\circ C.$ (Continued)

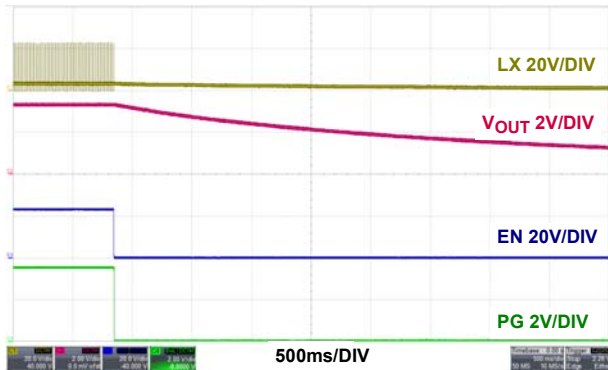

FIGURE 34. SHUTDOWN IN NO LOAD, PFM

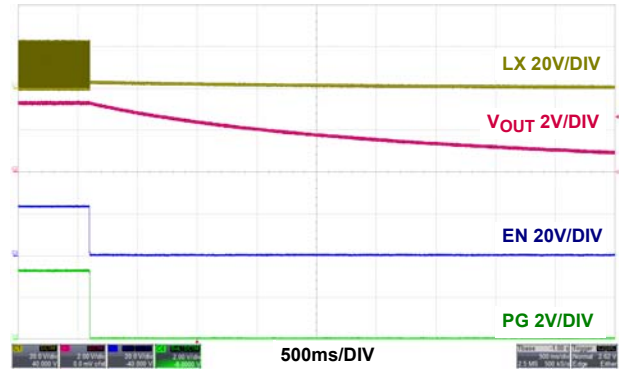

FIGURE 35. SHUTDOWN AT NO LOAD, PWM

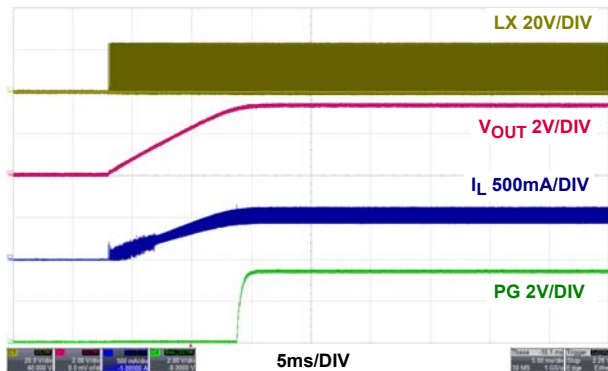

FIGURE 36. START-UP AT 500mA, PWM

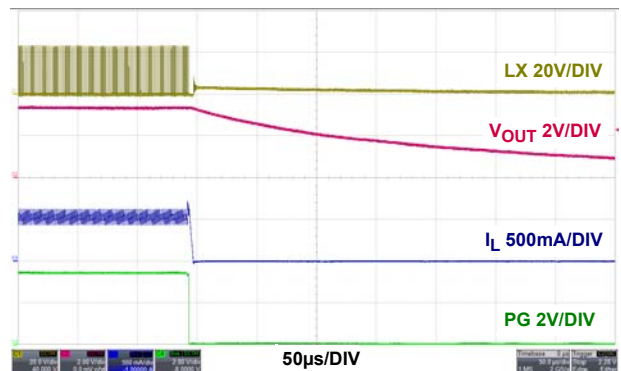

FIGURE 37. SHUTDOWN AT 500mA, PWM

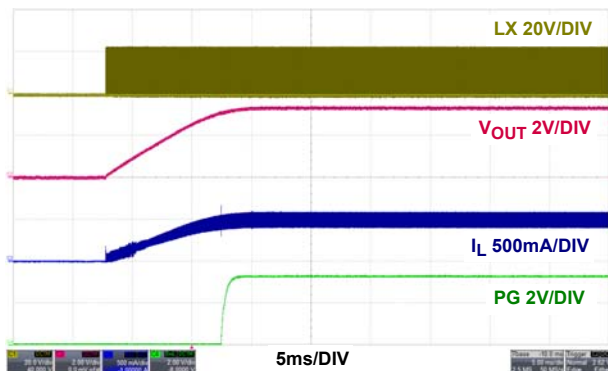

FIGURE 38. START-UP AT 500mA, PFM

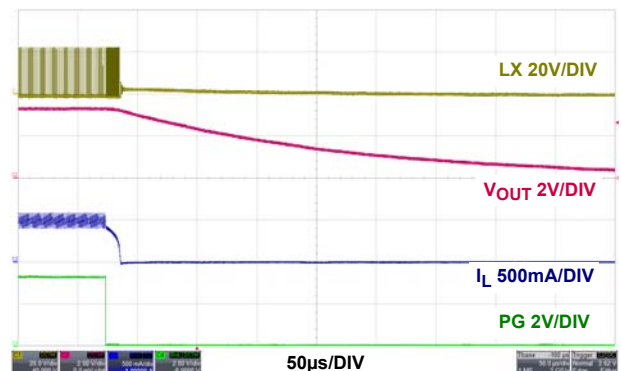

FIGURE 39. SHUTDOWN AT 500mA, PFM

## Typical Performance Curves $V_{IN} = 24V, V_{OUT} = 3.3V, SS = V_{CC}, F_{SW} = 800kHz, T_A = +25^\circ C.$ (Continued)

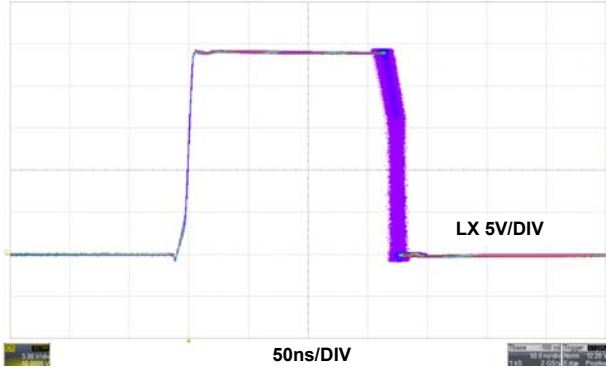

FIGURE 40. JITTER AT NO LOAD, PWM

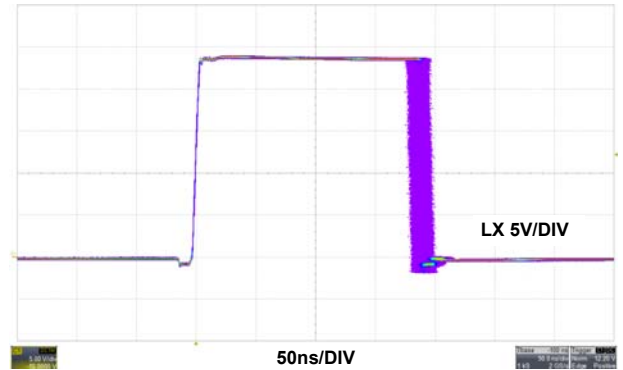

FIGURE 41. JITTER AT 500mA, PWM

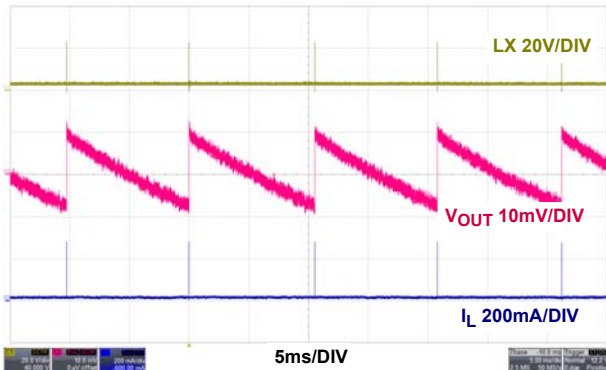

FIGURE 42. STEADY STATE AT NO LOAD, PFM

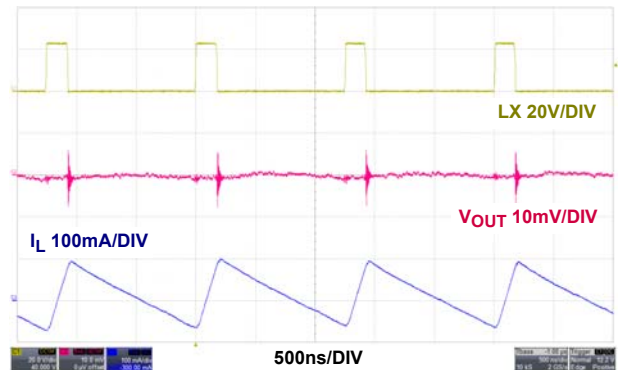

FIGURE 43. STEADY STATE AT NO LOAD, PWM

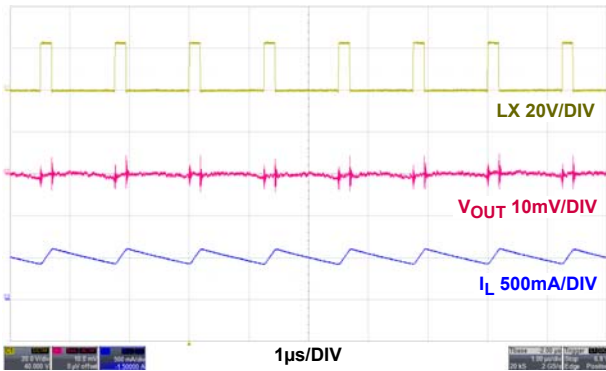

FIGURE 44. STEADY STATE AT 500mA LOAD, PWM

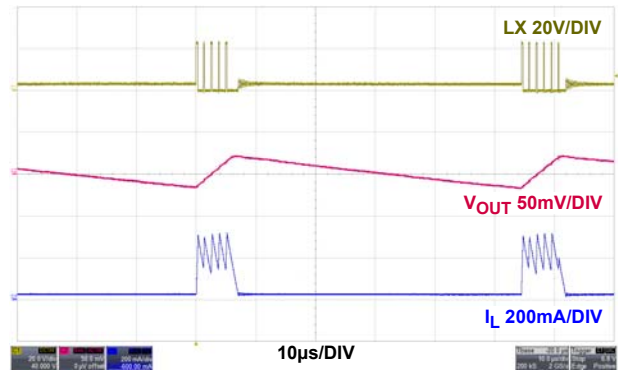

FIGURE 45. LIGHT LOAD OPERATION AT 20mA, PFM

## Typical Performance Curves $V_{IN} = 24V, V_{OUT} = 3.3V, SS = V_{CC}, F_{SW} = 800kHz, T_A = +25^\circ C.$ (Continued)

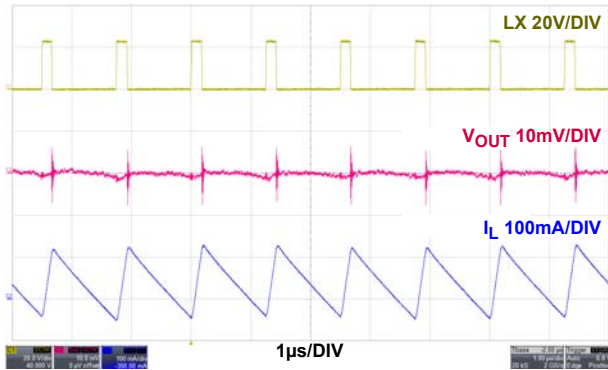

FIGURE 46. LIGHT LOAD OPERATION AT 20mA, PWM

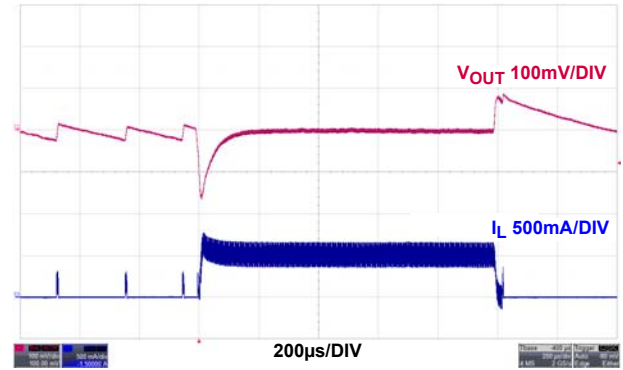

FIGURE 47. LOAD TRANSIENT, PFM

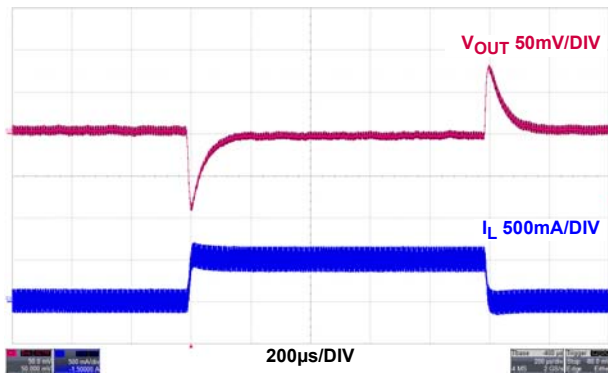

FIGURE 48. LOAD TRANSIENT, PWM

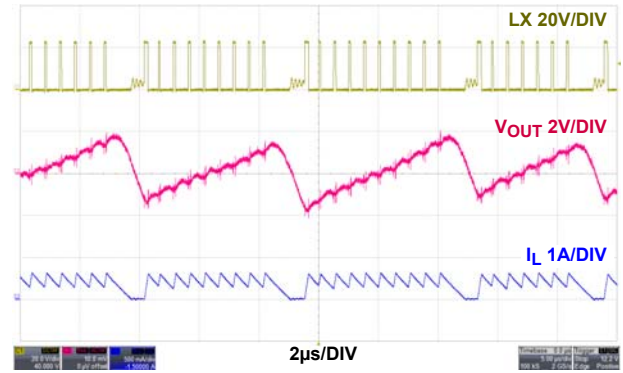

FIGURE 49. PFM TO PWM TRANSITION

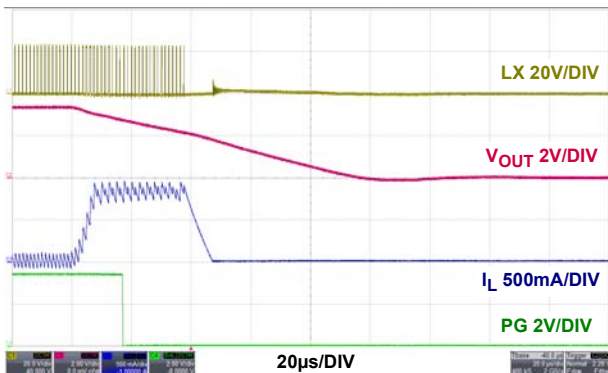

FIGURE 50. OVERCURRENT PROTECTION, PWM

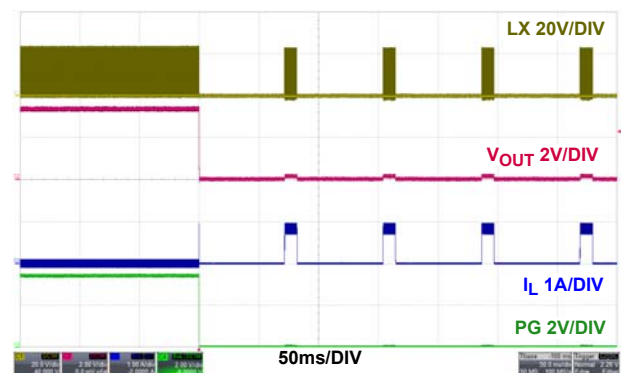

FIGURE 51. OVERCURRENT PROTECTION HICCUP, PWM

## Typical Performance Curves $V_{IN} = 24V, V_{OUT} = 3.3V, SS = V_{CC}, F_{SW} = 800kHz, T_A = +25^\circ C.$ (Continued)

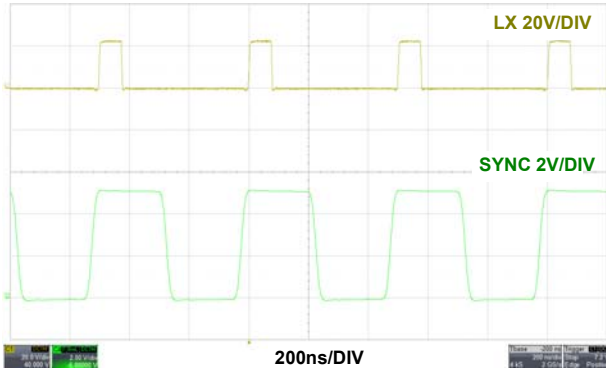

FIGURE 52. SYNC AT 500mA LOAD, PWM

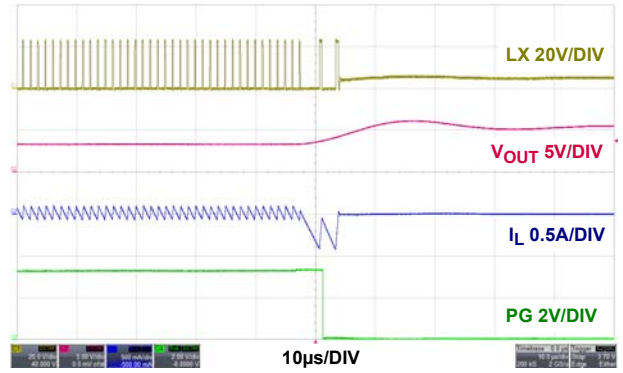

FIGURE 53. NEGATIVE CURRENT LIMIT, PWM

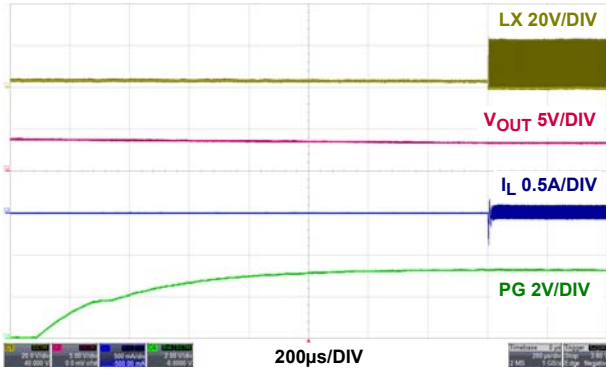

FIGURE 54. NEGATIVE CURRENT LIMIT RECOVERY, PWM

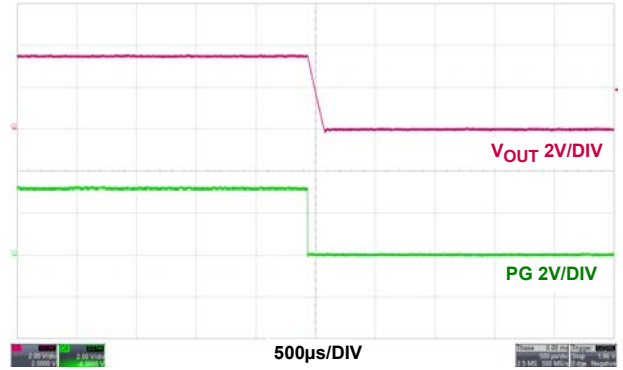

FIGURE 55. OVER-TEMPERATURE PROTECTION, PWM

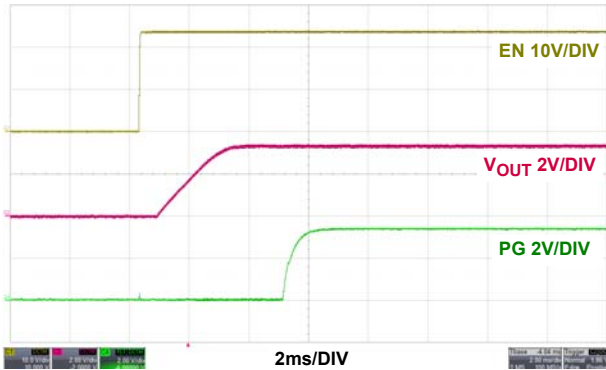

FIGURE 56. POWER-GOOD DELAY, PWM ( $I_{OUT} = 500mA$ )

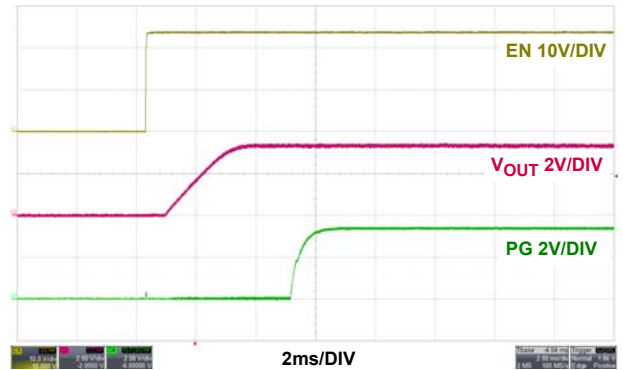

FIGURE 57. POWER-GOOD DELAY, PWM ( $I_{OUT} = 0A$ )

## Typical Performance Curves $V_{IN} = 24V, V_{OUT} = 3.3V, SS = V_{CC}, F_{SW} = 800kHz, T_A = +25^\circ C.$ (Continued)

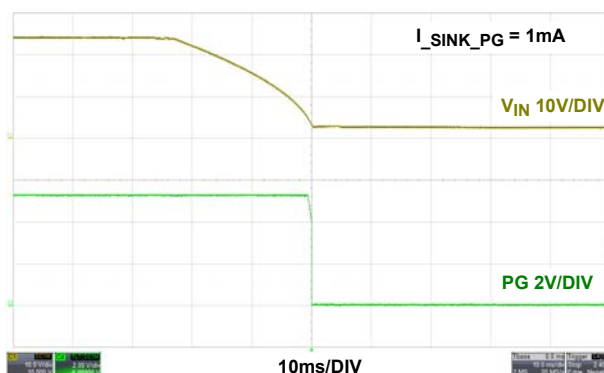

FIGURE 58. POWER-GOOD LOW WITH  $V_{IN} = 0$ , PWM

## Detailed Description

The ISL85415A combines a synchronous buck PWM controller with integrated power switches. The buck controller drives internal high-side and low-side N-channel MOSFETs to deliver load current up to 500mA. The buck regulator can operate from an unregulated DC source, such as a battery, with a voltage ranging from +3V to +36V. An internal LDO provides bias to the low voltage portions of the IC.

Peak current mode control is utilized to simplify feedback loop compensation and reject input voltage variation. User selectable internal feedback loop compensation further simplifies design. The ISL85415A switches at a default 500kHz.

The buck regulator is equipped with an internal current sensing circuit and the peak current limit threshold is typically set at 0.9A.

### Power-On Reset

The ISL85415A automatically initializes upon receipt of the input power supply and continually monitors the EN pin state. If EN is held below its logic rising threshold the IC is held in shutdown and consumes typically 1 $\mu$ A from the VIN supply. If EN exceeds its logic rising threshold, the regulator will enable the bias LDO and begin to monitor the VCC pin voltage. When the VCC pin voltage clears its rising POR threshold the controller will initialize the switching regulator circuits. If VCC never clears the rising POR threshold, the controller will not allow the switching regulator to operate. If VCC falls below its falling POR threshold while the switching regulator is operating, the switching regulator will be shut down until VCC returns.

### Soft-Start

To avoid large in-rush current,  $V_{OUT}$  is slowly increased at startup to its final regulated value. Soft-start time is determined by the SS pin connection. If SS is pulled to VCC, an internal 2ms timer is selected for soft-start. For other soft-start times, simply connect a capacitor from SS to GND. In this case, a 2 $\mu$ A current pulls up the SS voltage and the FB pin will follow this ramp until it reaches the 600mV reference level. Soft-start time for this case is described by Equation 1:

$$\text{Time(ms)} = C(nF) * 0.3 \quad (\text{EQ. 1})$$

### Power-Good

PG is the open-drain output of a window comparator that continuously monitors the buck regulator output voltage via the FB pin. PG is actively held low when EN is low and during the buck regulator soft-start period. After the soft-start period completes, PG becomes high impedance provided the FB pin is within the range specified in the “Electrical Specifications” on page 3. Should FB exit the specified window, PG will be pulled low until FB returns. Over-temperature faults also force PG low until the fault condition is cleared by an attempt to soft-start. There is an internal 5M $\Omega$  internal pull-up resistor.

### PWM Control Scheme

The ISL85415A employs peak current-mode pulse-width modulation (PWM) control for fast transient response and pulse-by-pulse current limiting, as shown in the “Functional Block Diagram” on page 5. The current loop consists of the current sensing circuit, slope compensation ramp, PWM comparator, oscillator and latch. Current sense trans-resistance is typically 600mV/A and slope compensation rate,  $S_e$ , is typically 450mV/T where T is the switching cycle period. The control reference for the current loop comes from the error amplifier’s output ( $V_{COMP}$ ).

A PWM cycle begins when a clock pulse sets the PWM latch and the upper FET is turned on. Current begins to ramp up in the upper FET and inductor. This current is sensed ( $V_{CSA}$ ), converted to a voltage and summed with the slope compensation signal. This combined signal is compared to  $V_{COMP}$  and when the signal is equal to  $V_{COMP}$ , the latch is reset. Upon latch reset the upper FET is turned off and the lower FET turned on allowing current to ramp down in the inductor. The lower FET will remain on until the clock initiates another PWM cycle. Figure 59 shows the typical operating waveforms during the PWM operation. The dotted lines illustrate the sum of the current sense and slope compensation signal.

Output voltage is regulated as the error amplifier varies  $V_{COMP}$  and thus output inductor current. The error amplifier is a trans-conductance type and its output (COMP) is terminated with a series RC network to GND. This termination is internal (150k/54pF) if the COMP pin is tied to VCC. Additionally, the

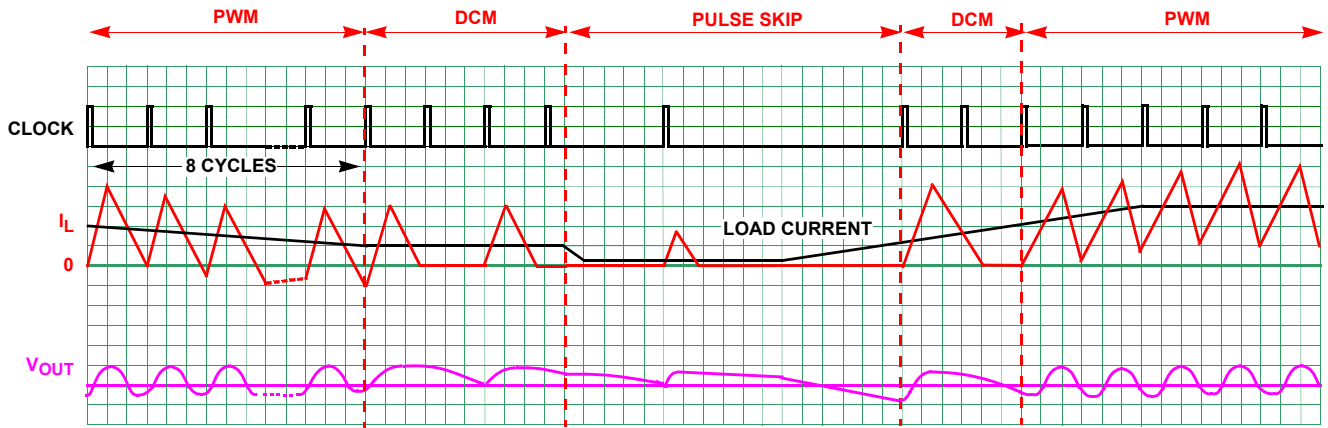

FIGURE 60. DCM MODE OPERATION WAVEFORMS

trans-conductance for COMP = V<sub>CC</sub> is 50μs vs 220μs for external RC connection. Its non-inverting input is internally connected to a 600mV reference voltage and its inverting input is connected to the output voltage via the FB pin and its associated divider network.

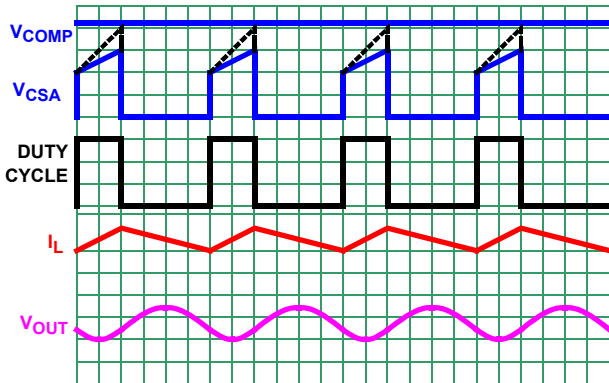

FIGURE 59. PWM OPERATION WAVEFORMS

## Light Load Operation

At light loads, converter efficiency may be improved by enabling variable frequency operation (PFM). Connecting the SYNC pin to GND will allow the controller to choose such operation automatically when the load current is low. Figure 60 shows the DCM operation. The IC enters the DCM mode of operation when 8 consecutive cycles of inductor current crossing zero are detected. This corresponds to a load current equal to 1/2 the peak-to-peak inductor ripple current and set by the following Equation 2:

$$I_{OUT} = \frac{V_{OUT}(1-D)}{2LF_s} \quad (EQ. 2)$$

where D = duty cycle, F<sub>s</sub> = switching frequency, L = inductor value, I<sub>OUT</sub> = output loading current, V<sub>OUT</sub> = output voltage.

While operating in PFM mode, the regulator controls the output voltage with a simple comparator and pulsed FET current. A comparator signals the point at which FB is equal to the 600mV reference at which time the regulator begins providing pulses of current until FB is moved above the 600mV reference by 1%. The current pulses are approximately 300mA and are issued at a

frequency equal to the converters programmed PWM operating frequency.

Due to the pulsed current nature of PFM mode, the converter can supply limited current to the load. Should load current rise beyond the limit, V<sub>OUT</sub> will begin to decline. A second comparator signals an FB voltage 1% lower than the 600mV reference and forces the converter to return to PWM operation.

## Output Voltage Selection

The regulator output voltage is easily programmed using an external resistor divider to scale V<sub>OUT</sub> relative to the internal reference voltage. The scaled voltage is applied to the inverting input of the error amplifier; refer to Figure 60.

The output voltage programming resistor, R<sub>3</sub>, depends on the value chosen for the feedback resistor, R<sub>2</sub>, and the desired output voltage, V<sub>OUT</sub>, of the regulator. Equation 3 describes the relationship between V<sub>OUT</sub> and resistor values.

$$R_3 = \frac{R_2 \times 0.6V}{V_{OUT} - 0.6V} \quad (EQ. 3)$$

If the desired output voltage is 0.6V, then R<sub>3</sub> is left unpopulated and R<sub>2</sub> is 0Ω.

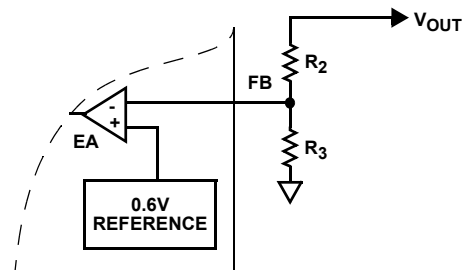

FIGURE 61. EXTERNAL RESISTOR DIVIDER

## Protection Features

The ISL85415A is protected from overcurrent, negative overcurrent and over-temperature. The protection circuits operate automatically.

## Overcurrent Protection

During PWM on-time, current through the upper FET is monitored and compared to a nominal 0.9A peak overcurrent limit. In the event that current reaches the limit, the upper FET will be turned off until the next switching cycle. In this way, FET peak current is always well limited.

If the overcurrent condition persists for 17 sequential clock cycles, the regulator will begin its hiccup sequence. In this case, both FETS will be turned off and PG will be pulled low. This condition will be maintained for 8 soft-start periods after which, the regulator will attempt a normal soft-start.

Should the output fault persist, the regulator will repeat the hiccup sequence indefinitely. There is no danger even if the output is shorted during soft-start.

If  $V_{OUT}$  is shorted very quickly, FB may collapse below  $5/8^{th}$  of its target value before 17 cycles of overcurrent are detected. The ISL85415A recognizes this condition and will begin to lower its switching frequency proportional to the FB pin voltage. This insures that under no circumstance (even with  $V_{OUT}$  near 0V) will the inductor current run away.

## Negative Current Limit

Should an external source somehow drive current into  $V_{OUT}$ , the controller will attempt to regulate  $V_{OUT}$  by reversing its inductor current to absorb the externally sourced current. In the event that the external source is low impedance, current may be reversed to unacceptable levels and the controller will initiate its negative current limit protection. Similar to normal overcurrent, the negative current protection is realized by monitoring the current through the lower FET. When the valley point of the inductor current reaches negative current limit, the lower FET is turned off and the upper FET is forced on until current reaches the **POSITIVE** current limit or an internal clock signal is issued. At this point, the lower FET is allowed to operate. Should the current again be pulled to the negative limit on the next cycle, the upper FET will again be forced on and current will be forced to  $1/6^{th}$  of the positive current limit. At this point the controller will turn off both FET's and wait for COMP to indicate return to normal operation. During this time, the controller will apply a  $100\Omega$  load from PHASE to PGND and attempt to discharge the output. Negative current limit is a pulse-by-pulse style operation and recovery is automatic. Negative current limit protection is disabled in PFM operating mode because reverse current is not allowed to build due to the diode emulation behavior of the lower FET.

## Over-Temperature Protection

Over-temperature protection limits maximum junction temperature in the ISL85415A. When junction temperature ( $T_J$ ) exceeds  $+150^\circ\text{C}$ , both FET's are turned off and the controller waits for temperature to decrease by approximately  $20^\circ\text{C}$ . During this time PG is pulled low. When temperature is within an acceptable range, the controller will initiate a normal soft-start sequence. For continuous operation, the  $+125^\circ\text{C}$  junction temperature rating should not be exceeded.

## Boot Undervoltage Protection

If the Boot capacitor voltage falls below 1.8V, the Boot undervoltage protection circuit will turn on the lower FET for

400ns to recharge the capacitor. This operation may arise during long periods of no switching such as PFM no load situations. In PWM operation near dropout ( $V_{IN}$  near  $V_{OUT}$ ), the regulator may hold the upper FET on for multiple clock cycles. To prevent the boot capacitor from discharging, the lower FET is forced on for approximately 200ns every 10 clock cycles.

## Application Guidelines

### Simplifying the Design

While the ISL85415A offers user programmed options for most parameters, the easiest implementation with fewest components involves selecting internal settings for SS, COMP and FS. Table 2 on page 4 provides component value selections for a variety of output voltages and will allow the designer to implement solutions with a minimum of effort.

### Operating Frequency

The ISL85415A operates at a default switching frequency of 500kHz if  $F_S$  is tied to  $V_{CC}$ . Tie a resistor from  $F_S$  to GND to program the switching frequency from 300kHz to 2MHz, as shown in Equation 4.

$$R_{FS}[\text{k}\Omega] = 108.75\text{k}\Omega \cdot (t - 0.2\mu\text{s}) / 1\mu\text{s} \quad (\text{EQ. 4})$$

Where:

t is the switching period in  $\mu\text{s}$ .

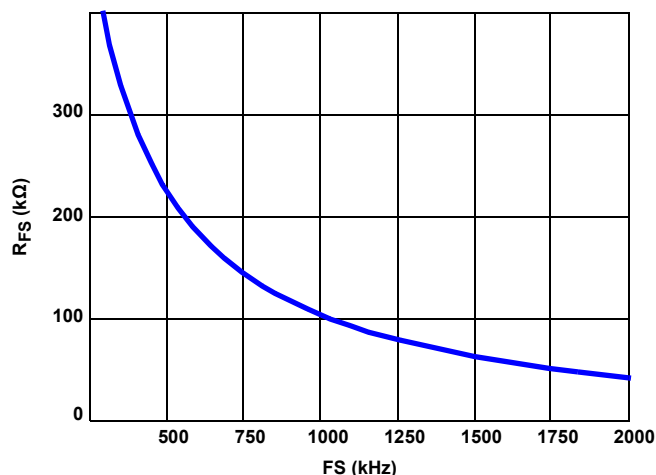

FIGURE 62.  $R_{FS}$  SELECTION vs  $F_S$

### Synchronization Control

The frequency of operation can be synchronized up to 2MHz by an external signal applied to the SYNC pin. The rising edge on the SYNC triggers the rising edge of PHASE. To properly sync, the external source must be at least 10% greater than the programmed free running IC frequency.

### Output Inductor Selection

The inductor value determines the converter's ripple current. Choosing an inductor current requires a somewhat arbitrary choice of ripple current,  $\Delta I$ . A reasonable starting point is 30% of total load current. The inductor value can then be calculated

using Equation 5:

$$L = \frac{V_{IN} - V_{OUT}}{FS \times DI} \times \frac{V_{OUT}}{V_{IN}} \quad (EQ. 5)$$

Increasing the value of inductance reduces the ripple current and thus, the ripple voltage. However, the larger inductance value may reduce the converter's response time to a load transient. The inductor current rating should be such that it will not saturate in overcurrent conditions. For typical ISL85415A applications, inductor values generally lies in the 10µH to 47µH range. In general, higher  $V_{OUT}$  will mean higher inductance.

## Buck Regulator Output Capacitor Selection

An output capacitor is required to filter the inductor current. The current mode control loop allows the use of low ESR ceramic capacitors and thus supports very small circuit implementations on the PC board. Electrolytic and polymer capacitors may also be used.

While ceramic capacitors offer excellent overall performance and reliability, the actual in-circuit capacitance must be considered. Ceramic capacitors are rated using large peak-to-peak voltage swings and with no DC bias. In the DC/DC converter application, these conditions do not reflect reality. As a result, the actual capacitance may be considerably lower than the advertised value. Consult the manufacturers data sheet to determine the actual in-application capacitance. Most manufacturers publish capacitance vs DC bias so that this effect can be easily accommodated. The effects of AC voltage are not frequently published, but an assumption of ~20% further reduction will generally suffice. The result of these considerations may mean an effective capacitance 50% lower than nominal and this value should be used in all design calculations. Nonetheless, ceramic capacitors are a very good choice in many applications due to their reliability and extremely low ESR.

The following equations allow calculation of the required capacitance to meet a desired ripple voltage level. Additional capacitance may be used.

For the ceramic capacitors (low ESR):

$$V_{OUTripple} = \frac{\Delta I}{8 \cdot F_{SW} \cdot C_{OUT}} \quad (EQ. 6)$$

where  $\Delta I$  is the inductor's peak-to-peak ripple current,  $F_{SW}$  is the switching frequency and  $C_{OUT}$  is the output capacitor.

If using electrolytic capacitors then:

$$V_{OUTripple} = \Delta I \cdot ESR \quad (EQ. 7)$$

## Loop Compensation Design

When COMP is not connected to VCC, the COMP pin is active for external loop compensation. The ISL85415A uses constant frequency peak current mode control architecture to achieve a fast loop transient response. An accurate current sensing pilot device in parallel with the upper MOSFET is used for peak current control signal and overcurrent protection. The inductor is not considered as a state variable since its peak current is constant, and the system becomes a single order system. It is much easier to design a type II compensator to stabilize the loop than to

implement voltage mode control. Peak current mode control has an inherent input voltage feed-forward function to achieve good line regulation. Figure 63 shows the small signal model of the synchronous buck regulator.

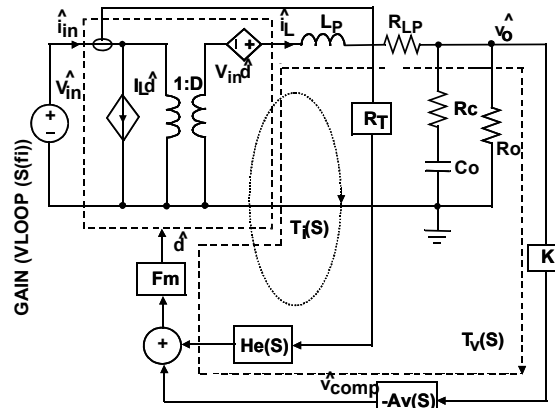

FIGURE 63. SMALL SIGNAL MODEL OF SYNCHRONOUS BUCK REGULATOR

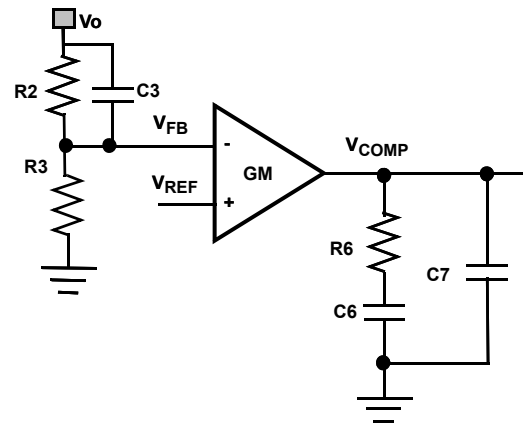

FIGURE 64. TYPE II COMPENSATOR

Figure 64 shows the type II compensator and its transfer function is expressed, as shown in Equation 8:

$$A_v(S) = \frac{\hat{V}_{COMP}}{\hat{V}_{FB}} = \frac{GM \cdot R_3}{(C_6 + C_7) \cdot (R_2 + R_3)} \frac{\left(1 + \frac{S}{\omega_{cz1}}\right) \left(1 + \frac{S}{\omega_{cz2}}\right)}{S \left(1 + \frac{S}{\omega_{cp1}}\right) \left(1 + \frac{S}{\omega_{cp2}}\right)} \quad (EQ. 8)$$

where,

$$\omega_{cz1} = \frac{1}{R_6 C_6}, \quad \omega_{cz2} = \frac{1}{R_2 C_3}, \quad \omega_{cp1} = \frac{C_6 + C_7}{R_6 C_6 C_7}, \quad \omega_{cp2} = \frac{R_2 + R_3}{C_3 R_2 R_3}$$

Compensator design goal:

High DC gain

Choose Loop bandwidth  $f_c$  less than 100kHz

Gain margin: >10dB

Phase margin: >40°

The compensator design procedure is as follows:

The loop gain at crossover frequency of  $f_c$  has a unity gain. Therefore, the compensator resistance  $R_6$  is determined by Equation 9.

$$R_6 = \frac{2\pi f_c V_o C_o R_t}{GM \cdot V_{FB}} = 31.4 \times 10^3 \cdot f_c V_o C_o \quad (\text{EQ. 9})$$

Where  $GM$  is the trans-conductance,  $g_m$ , of the voltage error amplifier in each phase. Compensator capacitor  $C_6$  is then given by Equation 10.

$$C_6 = \frac{R_o C_o}{R_6} = \frac{V_o C_o}{I_o R_6}, C_7 = \max\left(\frac{R_c C_o}{R_6}, \frac{1}{\pi f_s R_6}\right) \quad (\text{EQ. 10})$$

Put one compensator pole at zero frequency to achieve high DC gain, and put another compensator pole at either ESR zero frequency or half switching frequency, whichever is lower in Equation 10. An optional zero can boost the phase margin.  $\omega_{CZ2}$  is a zero due to  $R_2$  and  $C_3$ .

Put compensator zero 2 to 5 times  $f_c$

$$C_3 = \frac{1}{\pi f_c R_2} \quad (\text{EQ. 11})$$

Example:  $V_{IN} = 12V$ ,  $V_o = 5V$ ,  $I_o = 500mA$ ,  $f_s = 500kHz$ ,  $R_2 = 90.9k\Omega$ ,  $R_3 = xxk\Omega$ ,  $C_o = 22\mu F/5m\Omega$ ,  $L = 39\mu H$ ,  $f_c = 50kHz$ , then compensator resistance  $R_6$ :

$$R_6 = 31.4 \times 10^3 \cdot 50kHz \cdot 5V \cdot 22\mu F = 157k\Omega \quad (\text{EQ. 12})$$

It is acceptable to use  $150k\Omega$  as the closest standard value for  $R_6$ .

$$C_6 = \frac{5V \cdot 22\mu F}{500mA \cdot 150k\Omega} = 1.46nF \quad (\text{EQ. 13})$$

$$C_7 = \max\left(\frac{5m\Omega \cdot 22\mu F}{150k\Omega}, \frac{1}{\pi \cdot 500kHz \cdot 150k\Omega}\right) = (0.7pF, 4.2pF) \quad (\text{EQ. 14})$$

It is also acceptable to use the closest standard values for  $C_6$  and  $C_7$ . There is approximately  $3pF$  parasitic capacitance from  $V_{COMP}$  to  $GND$ ; Therefore,  $C_7$  is optional. Use  $C_6 = 1500pF$  and  $C_7 = OPEN$ .

$$C_3 = \frac{1}{\pi \cdot 50kHz \cdot 90.9k\Omega} = 70pF \quad (\text{EQ. 15})$$

Use  $C_3 = 68pF$ . Note that  $C_3$  may increase the loop bandwidth from previous estimated value. Figure 65 shows the simulated voltage loop gain. It is shown that it has a  $75kHz$  loop bandwidth with a  $61^\circ$  phase margin and  $6dB$  gain margin. It may be more

desirable to achieve an increased gain margin. This can be accomplished by lowering  $R_6$  by 20% to 30%.

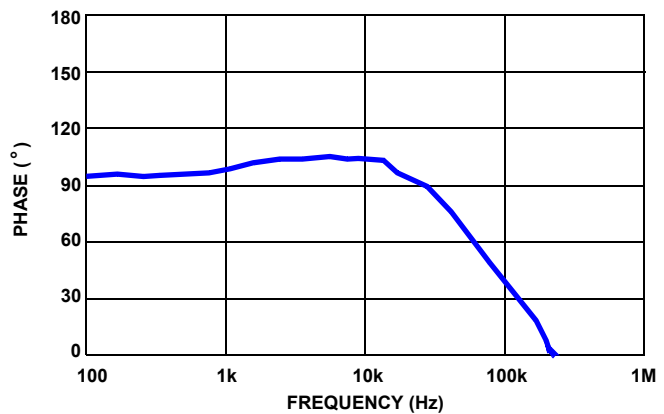
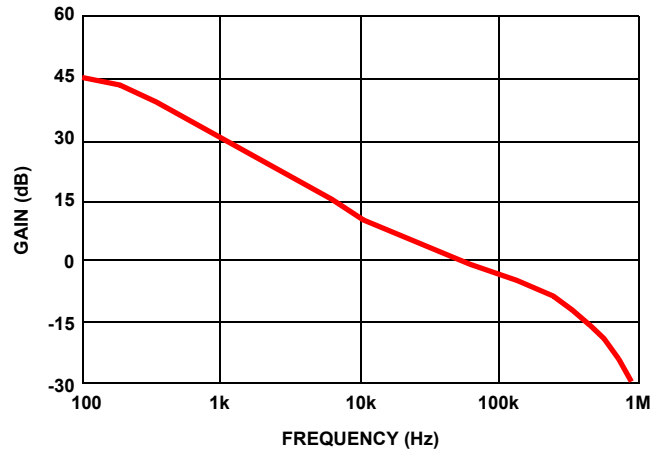

FIGURE 65. SIMULATED LOOP GAIN

## Layout Considerations

Proper layout of the power converter will minimize EMI and noise and insure first pass success of the design. PCB layouts are provided in multiple formats on the Intersil web site. In addition, Figure 66 will make clear the important points in PCB layout. In reality, PCB layout of the ISL85415A is quite simple.

A multi-layer printed circuit board with GND plane is recommended. Figure 66 shows the connections of the critical components in the converter. Note that capacitors  $C_{IN}$  and  $C_{OUT}$  could each represent multiple physical capacitors. The most critical connections are to tie the PGND pin to the package GND pad and then use vias to directly connect the GND pad to the system GND plane. This connection of the GND pad to system plane insures a low impedance path for all return current, as well as an excellent thermal path to dissipate heat. With this connection made, place the high frequency MLCC input capacitor near the  $V_{IN}$  pin and use vias directly at the capacitor pad to tie the capacitor to the system GND plane.

The boot capacitor is easily placed on the PCB side opposite the controller IC and 2 vias directly connect the capacitor to BOOT and PHASE.

Place a  $1\mu F$  MLCC near the VCC pin and directly connect its return with a via to the system GND plane.

# ISL85415A

Place the feedback divider close to the FB pin and do not route any feedback components near PHASE or BOOT. If external components are used for SS, COMP or FS the same advice applies.

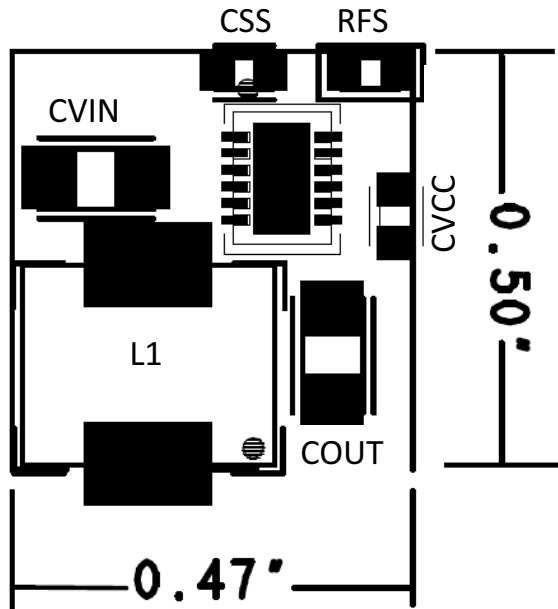

FIGURE 66. PRINTED CIRCUIT BOARD POWER PLANES AND ISLANDS

## Revision History

The revision history provided is for informational purposes only and is believed to be accurate, but not warranted. Please go to web to make sure you have the latest revision.

DATE	REVISION	CHANGE
July 11, 2013	FN8414.0	Initial Release.

## About Intersil

Intersil Corporation is a leader in the design and manufacture of high-performance analog, mixed-signal and power management semiconductors. The company's products address some of the largest markets within the industrial and infrastructure, personal computing and high-end consumer markets. For more information about Intersil, visit our website at [www.intersil.com](http://www.intersil.com).

For the most updated datasheet, application notes, related documentation and related parts, please see the respective product information page found at [www.intersil.com](http://www.intersil.com). You may report errors or suggestions for improving this datasheet by visiting [www.intersil.com/en/support/ask-an-expert.html](http://www.intersil.com/en/support/ask-an-expert.html). Reliability reports are also available from our website at <http://www.intersil.com/en/support/qualandreliability.html#reliability>

For additional products, see [www.intersil.com/en/products.html](http://www.intersil.com/en/products.html)

Intersil products are manufactured, assembled and tested utilizing ISO9000 quality systems as noted in the quality certifications found at [www.intersil.com/en/support/qualandreliability.html](http://www.intersil.com/en/support/qualandreliability.html)

*Intersil products are sold by description only. Intersil Corporation reserves the right to make changes in circuit design, software and/or specifications at any time without notice. Accordingly, the reader is cautioned to verify that data sheets are current before placing orders. Information furnished by Intersil is believed to be accurate and reliable. However, no responsibility is assumed by Intersil or its subsidiaries for its use; nor for any infringements of patents or other rights of third parties which may result from its use. No license is granted by implication or otherwise under any patent or patent rights of Intersil or its subsidiaries.*

For information regarding Intersil Corporation and its products, see [www.intersil.com](http://www.intersil.com)

## Package Outline Drawing L12.4x3

12 LEAD DUAL FLAT NO-LEAD PLASTIC PACKAGE

Rev 2, 7/10

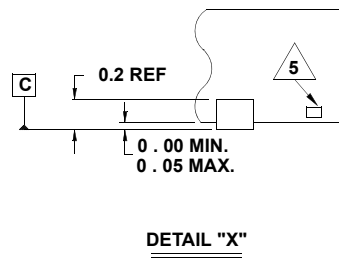
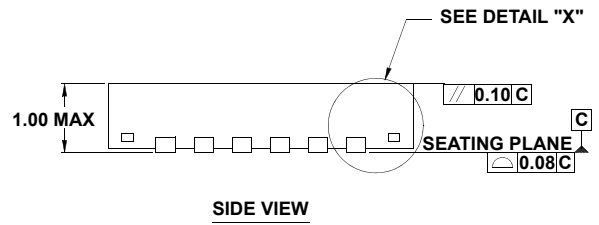
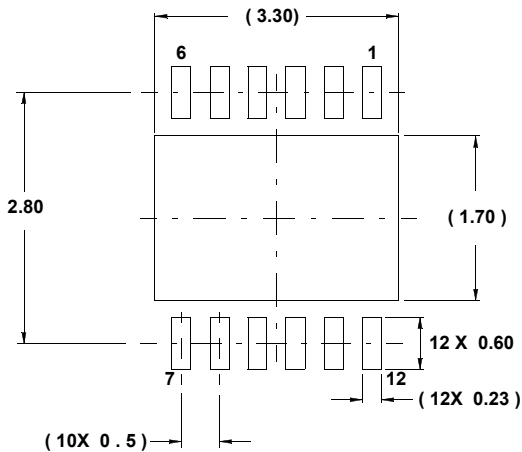
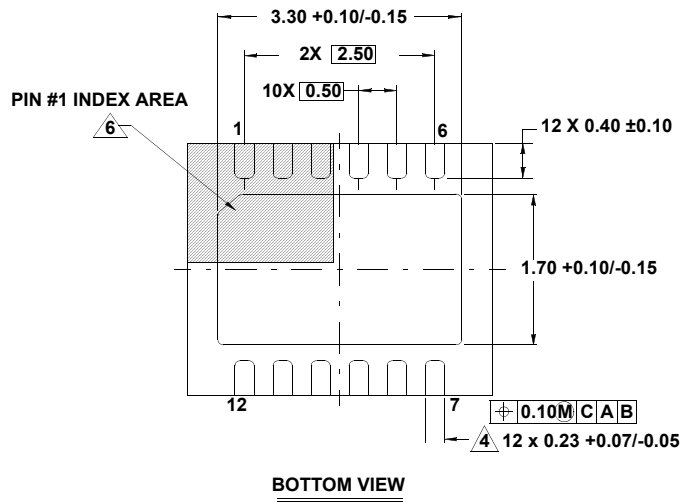
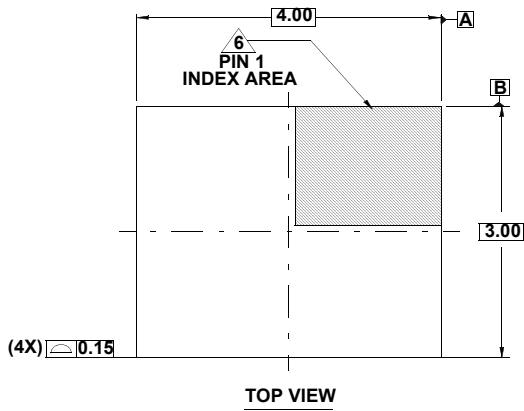

### NOTES:

- Dimensions are in millimeters.  
Dimensions in ( ) for Reference Only.
- Dimensioning and tolerancing conform to AMSE Y14.5m-1994.
- Unless otherwise specified, tolerance : Decimal  $\pm 0.05$
- Dimension applies to the metallized terminal and is measured between 0.15mm and 0.30mm from the terminal tip.
- Tiebar shown (if present) is a non-functional feature.
- The configuration of the pin #1 identifier is optional, but must be located within the zone indicated. The pin #1 identifier may be either a mold or mark feature.
- Compliant to JEDEC MO-229 V4030D-4 issue E.

## Looking for pricing, stock, or lifecycle information?

Click below to explore more details on WIN SOURCE:

 [View ISL85415AIRZ on WIN SOURCE](#)

 [Intersil Information](#)

## Optimize Your Supply Chain with WIN SOURCE Solutions

-  Global Sourcing Solution
-  Obsolete Management
-  Cost Control Management
-  Shortage Management
-  Alternative Solution
-  Excess Inventory Management