



**THE DATASHEET OF
KA7915ATU**





Is Now Part of



ON Semiconductor®

To learn more about ON Semiconductor, please visit our website at
www.onsemi.com

Please note: As part of the Fairchild Semiconductor integration, some of the Fairchild orderable part numbers will need to change in order to meet ON Semiconductor's system requirements. Since the ON Semiconductor product management systems do not have the ability to manage part nomenclature that utilizes an underscore (_), the underscore (_) in the Fairchild part numbers will be changed to a dash (-). This document may contain device numbers with an underscore (_). Please check the ON Semiconductor website to verify the updated device numbers. The most current and up-to-date ordering information can be found at www.onsemi.com. Please email any questions regarding the system integration to Fairchild_questions@onsemi.com.

ON Semiconductor and the ON Semiconductor logo are trademarks of Semiconductor Components Industries, LLC dba ON Semiconductor or its subsidiaries in the United States and/or other countries. ON Semiconductor owns the rights to a number of patents, trademarks, copyrights, trade secrets, and other intellectual property. A listing of ON Semiconductor's product/patent coverage may be accessed at www.onsemi.com/site/pdf/Patent-Marking.pdf. ON Semiconductor reserves the right to make changes without further notice to any products herein. ON Semiconductor makes no warranty, representation or guarantee regarding the suitability of its products for any particular purpose, nor does ON Semiconductor assume any liability arising out of the application or use of any product or circuit, and specifically disclaims any and all liability, including without limitation special, consequential or incidental damages. Buyer is responsible for its products and applications using ON Semiconductor products, including compliance with all laws, regulations and safety requirements or standards, regardless of any support or applications information provided by ON Semiconductor. "Typical" parameters which may be provided in ON Semiconductor data sheets and/or specifications can and do vary in different applications and actual performance may vary over time. All operating parameters, including "Typicals" must be validated for each customer application by customer's technical experts. ON Semiconductor does not convey any license under its patent rights nor the rights of others. ON Semiconductor products are not designed, intended, or authorized for use as a critical component in life support systems or any FDA Class 3 medical devices or medical devices with a same or similar classification in a foreign jurisdiction or any devices intended for implantation in the human body. Should Buyer purchase or use ON Semiconductor products for any such unintended or unauthorized application, Buyer shall indemnify and hold ON Semiconductor and its officers, employees, subsidiaries, affiliates, and distributors harmless against all claims, costs, damages, and expenses, and reasonable attorney fees arising out of, directly or indirectly, any claim of personal injury or death associated with such unintended or unauthorized use, even if such claim alleges that ON Semiconductor was negligent regarding the design or manufacture of the part. ON Semiconductor is an Equal Opportunity/Affirmative Action Employer. This literature is subject to all applicable copyright laws and is not for resale in any manner.



September 2014

KA79XX / KA79XXA / LM79XX

3-Terminal 1 A Negative Voltage Regulator

Features

- Output Current in Excess of 1 A
- Output Voltages of: -5 V, -6 V, -8 V, -9 V, -12 V, -15 V, -18 V, -24 V
- Internal Thermal Overload Protection
- Short-Circuit Protection
- Output Transistor Safe Operating Area Compensation

Description

The KA79XX / KA79XXA / LM79XX series of three-terminal negative regulators are available in a TO-220 package with several fixed output voltages, making them useful in a wide range of applications. Each type employs internal current limiting, thermal shutdown, and safe operating area protection.

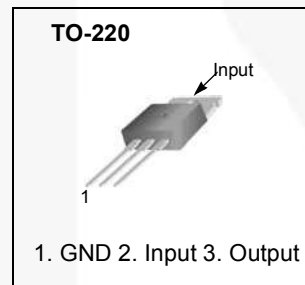

Ordering Information

Product Number	Output Voltage Tolerance	Package	Packing Method	Operating Temperature
KA7905TU	±4%	TO-220 (Dual Gauge)	Rail	0 to +125°C
KA7906TU				
KA7908TU				
KA7909TU				
KA7912TU				
KA7915TU				
KA7918TU				
KA7924TU				
KA7912ATU	±2%			
KA7915ATU				
LM7905CT	±4%	TO-220 (Single Gauge)		
LM7908CT				
LM7909CT				
LM7910CT				
LM7912CT				
LM7915CT				
LM7918CT				

KA79XX / KA79XXA / LM79XX — 3-Terminal 1 A Negative Voltage Regulator

Block Diagram

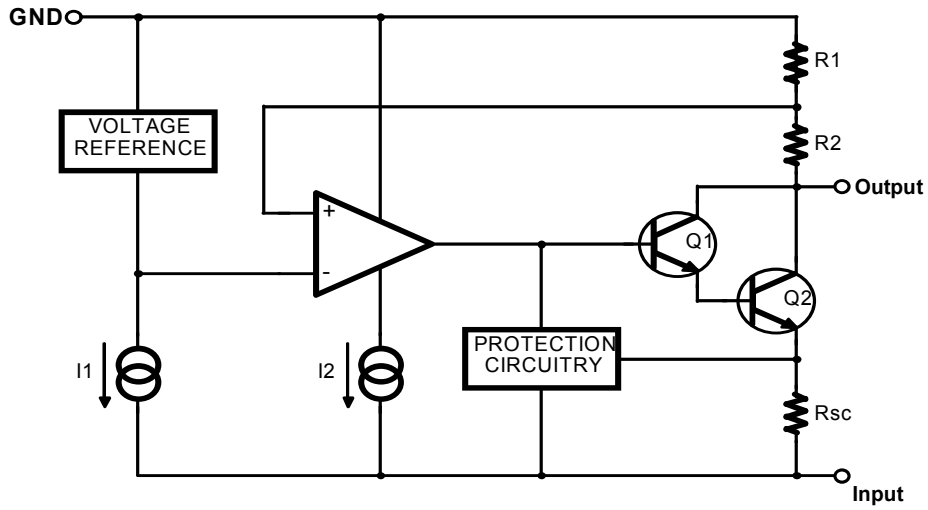

Figure 1. Block Diagram

Absolute Maximum Ratings

Stresses exceeding the absolute maximum ratings may damage the device. The device may not function or be operable above the recommended operating conditions and stressing the parts to these levels is not recommended. In addition, extended exposure to stresses above the recommended operating conditions may affect device reliability. The absolute maximum ratings are stress ratings only. Values are at $T_A = 25^\circ\text{C}$ unless otherwise noted.

Symbol	Parameter	Value	Unit
V_I	Input Voltage	-35	V
$R_{\theta JC}$	Thermal Resistance, Junction-Case ⁽¹⁾	5	$^\circ\text{C}/\text{W}$
$R_{\theta JA}$	Thermal Resistance, Junction-Air ^(1, 2)	65	$^\circ\text{C}/\text{W}$
T_{OPR}	Operating Temperature Range	0 to +125	$^\circ\text{C}$
T_{STG}	Storage Temperature Range	- 65 to +150	$^\circ\text{C}$

Notes:

1. Thermal resistance test board, size: 76.2 mm x 114.3 mm x 1.6 mm(1S0P), JEDEC standard: JESD51-3, JESD51-7.
2. Assume no ambient airflow.

Electrical Characteristics (KA7905 / LM7905)(V_I = -10 V, I_O = 500 mA, 0°C ≤ T_J ≤ +125°C, C_I = 2.2 μF, C_O = 1 μF; unless otherwise specified.)

Symbol	Parameter	Conditions	Min.	Typ.	Max.	Unit	
V _O	Output Voltage	T _J = +25°C	-4.80	-5.00	-5.20	V	
		I _O = 5 mA to 1 A, P _O ≤ 15 W, V _I = -7 V to -20 V	-4.75	-5.00	-5.25		
ΔV _O	Line Regulation ⁽³⁾	T _J = +25°C	V _I = -7 V to -25 V		35	100	mV
			V _I = -8 V to -12 V		8	50	
ΔV _O	Load Regulation ⁽³⁾	T _J = +25°C, I _O = 5 mA to 1.5 A			10	100	mV
		T _J = +25°C, I _O = 250 mA to 750 mA			3	50	
I _Q	Quiescent Current	T _J = +25°C			3	6	mA
ΔI _Q	Quiescent Current Change	I _O = 5 mA to 1 A			0.05	0.50	mA
		V _I = -8 V to -25 V			0.10	0.80	
ΔV _O /ΔT	Temperature Coefficient of V _D	I _O = 5 mA			-0.4		mV/°C
V _N	Output Noise Voltage	f = 10 Hz to 100 kHz, T _A = +25°C			40		μV
RR	Ripple Rejection	f = 120 Hz, ΔV _I = 10 V		54	60		dB
V _D	Dropout Voltage	T _J = +25°C, I _O = 1 A			2		V
I _{SC}	Short-Circuit Current	T _J = +25°C, V _I = -35 V			300		mA
I _{PK}	Peak Current	T _J = +25°C			2.2		A

Note:

3. Load and line regulation are specified at constant junction temperature. Changes in V_O due to heating effects must be taken into account separately. Pulse testing with low duty is used.

Electrical Characteristics (KA7906)(V_I = -11 V, I_O = 500 mA, 0°C ≤ T_J ≤ +125°C, C_I = 2.2 μF, C_O = 1 μF; unless otherwise specified.)

Symbol	Parameter	Conditions	Min.	Typ.	Max.	Unit	
V _O	Output Voltage	T _J = +25°C	-5.75	-6.00	-6.25	V	
		I _O = 5 mA to 1 A, P _O ≤ 15 W, V _I = -9 V to -21 V	-5.70	-6.00	-6.30		
ΔV _O	Line Regulation ⁽⁴⁾	T _J = +25°C	V _I = -8 V to -25 V		10	120	mV
			V _I = -9 V to -13 V		5	60	
ΔV _O	Load Regulation ⁽⁴⁾	T _J = +25°C, I _O = 5 mA to 1.5 A			10	120	mV
		T _J = +25°C, I _O = 250 mA to 750 mA			3	60	
I _Q	Quiescent Current	T _J = +25°C			3	6	mA
ΔI _Q	Quiescent Current Change	I _O = 5 mA to 1 A			0.05	0.50	mA
		V _I = -8 V to -25 V			0.10	1.30	
ΔV _O /ΔT	Temperature Coefficient of V _D	I _O = 5 mA			-0.5		mV/°C
V _N	Output Noise Voltage	f = 10 Hz to 100 kHz, T _A = +25°C			130		μV
RR	Ripple Rejection	f = 120 Hz, ΔV _I = 10 V		54	60		dB
V _D	Dropout Voltage	T _J = +25°C, I _O = 1 A			2		V
I _{SC}	Short-Circuit Current	T _J = +25°C, V _I = -35 V			300		mA
I _{PK}	Peak Current	T _J = +25°C			2.2		A

Note:

4. Load and line regulation are specified at constant junction temperature. Changes in V_O due to heating effects must be taken into account separately. Pulse testing with low duty is used.

Electrical Characteristics (KA7908 / LM7908)(V_I = -14 V, I_O = 500 mA, 0°C ≤ T_J ≤ +125°C, C_I = 2.2 μF, C_O = 1 μF; unless otherwise specified.)

Symbol	Parameter	Conditions	Min.	Typ.	Max.	Unit
V _O	Output Voltage	T _J = +25°C	-7.7	-8.0	-8.3	V
		I _O = 5 mA to 1 A, P _O ≤ 15 W, V _I = -10 V to -23 V	-7.6	-8.0	-8.4	
ΔV _O	Line Regulation ⁽⁵⁾	T _J = +25°C	V _I = -10.5 V to -25 V	10	160	mV
			V _I = -11 V to -17 V	5	80	
ΔV _O	Load Regulation ⁽⁵⁾	T _J = +25°C, I _O = 5 mA to 1.5 A		12	160	mV
		T _J = +25°C, I _O = 250 mA to 750 mA		4	80	
I _Q	Quiescent Current	T _J = +25°C		3	6	mA
ΔI _Q	Quiescent Current Change	I _O = 5 mA to 1 A		0.05	0.50	mA
		V _I = -10.5 V to -25 V		0.10	1.00	
ΔV _O /ΔT	Temperature Coefficient of V _D	I _O = 5 mA		-0.6		mV/°C
V _N	Output Noise Voltage	f = 10 Hz to 100 kHz, T _A = +25°C		175		μV
RR	Ripple Rejection	f = 120 Hz, ΔV _I = 10 V		54	60	dB
V _D	Dropout Voltage	T _J = +25°C, I _O = 1 A		2		V
I _{SC}	Short-Circuit Current	T _J = +25°C, V _I = -35 V		300		mA
I _{PK}	Peak Current	T _J = +25°C		2.2		A

Note:

5. Load and line regulation are specified at constant junction temperature. Changes in V_O due to heating effects must be taken into account separately. Pulse testing with low duty is used.

Electrical Characteristics (KA7909 / LM7909)(V_I = -15 V, I_O = 500 mA, 0°C ≤ T_J ≤ +125°C, C_I = 2.2 μF, C_O = 1 μF; unless otherwise specified.)

Symbol	Parameter	Conditions	Min.	Typ.	Max.	Unit
V _O	Output Voltage	T _J = +25°C	-8.7	-9.0	-9.3	V
		I _O = 5 mA to 1 A, P _O ≤ 15 W, V _I = -1.5 V to -23 V	-8.6	-9.0	-9.4	
ΔV _O	Line Regulation ⁽⁶⁾	T _J = +25°C	V _I = -11.5 V to -26 V	10	180	mV
			V _I = -12 V to -18 V	5	90	
ΔV _O	Load Regulation ⁽⁶⁾	T _J = +25°C, I _O = 5 mA to 1.5 A		12	180	mV
		T _J = +25°C, I _O = 250 mA to 750 mA		4	90	
I _Q	Quiescent Current	T _J = +25°C		3	6	mA
ΔI _Q	Quiescent Current Change	I _O = 5 mA to 1 A		0.05	0.50	mA
		V _I = -11.5 V to -26 V		0.10	1.00	
ΔV _O /ΔT	Temperature Coefficient of V _D	I _O = 5 mA		-0.6		mV/°C
V _N	Output Noise Voltage	f = 10 Hz to 100 kHz, T _A = +25°C		175		μV
RR	Ripple Rejection	f = 120 Hz, ΔV _I = 10 V		54	60	dB
V _D	Dropout Voltage	T _J = +25°C, I _O = 1 A		2		V
I _{SC}	Short-Circuit Current	T _J = +25°C, V _I = -35 V		300		mA
I _{PK}	Peak Current	T _J = +25°C		2.2		A

Note:

6. Load and line regulation are specified at constant junction temperature. Changes in V_O due to heating effects must be taken into account separately. Pulse testing with low duty is used.

Electrical Characteristics (LM7910)(V_I = -17 V, I_O = 500 mA, 0°C ≤ T_J ≤ +125°C, C_I = 2.2 μF, C_O = 1 μF; unless otherwise specified.)

Symbol	Parameter	Conditions	Min.	Typ.	Max.	Unit
V _O	Output Voltage	T _J = +25°C	-9.6	-10.0	-10.4	V
		I _O = 5 mA to 1A, P _d ≤ 15 W, V _I = -12 V to -28 V	-9.5	-10.0	-10.5	
ΔV _O	Line Regulation ⁽⁷⁾	T _J = +25°C	V _I = -12.5 V to -28 V	12	200	mV
			V _I = -14 V to -20 V	6	100	
ΔV _O	Load Regulation ⁽⁷⁾	T _J = +25°C, I _O = 5 mA to 1.5 A		12	200	mV
		T _J = +25°C, I _O = 250 mA to 750 mA		4	100	
I _Q	Quiescent Current	T _J = +25°C		3	6	mA
ΔI _Q	Quiescent Current Change	I _O = 5 mA to 1 A		0.05	0.50	mA
		V _I = -12.5 V to -28 V		0.10	1.00	
ΔV _O /ΔT	Temperature Coefficient of V _O	I _O = 5 mA		-1		mV/°C
V _N	Output Noise Voltage	10 Hz ≤ f ≤ 100 kHz, T _A = +25°C		280		μV
RR	Ripple Rejection	f = 120 Hz, ΔV _I = 10 V	54	60		dB
V _D	Dropout Voltage	T _J = +25°C, I _O = 1 A		2		V
I _{SC}	Short-Circuit Current	T _J = +25°C, V _I = -35 V		300		mA
I _{PK}	Peak Current	T _J = +25°C		2.2		A

Note:

7. Load and line regulation are specified at constant junction temperature. Changes in V_O due to heating effects must be taken into account separately. Pulse testing with low duty is used.

Electrical Characteristics (KA7912 / LM7912)(V_I = -19 V, I_O = 500 mA, 0°C ≤ T_J ≤ +125°C, C_I = 2.2 μF, C_O = 1 μF; unless otherwise specified.)

Symbol	Parameter	Conditions	Min.	Typ.	Max.	Unit
V _O	Output Voltage	T _J = +25°C	-11.5	-12.0	-12.5	V
		I _O = 5 mA to 1 A, P _O ≤ 15 W V _I = -15.5 V to -27 V	-11.4	-12.0	-12.6	
ΔV _O	Line Regulation ⁽⁸⁾	T _J = +25°C	V _I = -14.5 V to -30 V	12	240	mV
			V _I = -16 V to -22 V	6	120	
ΔV _O	Load Regulation ⁽⁸⁾	T _J = +25°C, I _O = 5 mA to 1.5 A		12	240	mV
		T _J = +25°C, I _O = 250 mA to 750 mA		4	120	
I _Q	Quiescent Current	T _J = +25°C		3	6	mA
ΔI _Q	Quiescent Current Change	I _O = 5 mA to 1 A		0.05	0.50	mA
		V _I = -14.5 V to -30 V		0.10	1.00	
ΔV _O /ΔT	Temperature Coefficient of V _D	I _O = 5 mA		-0.8		mV/°C
V _N	Output Noise Voltage	f = 10 Hz to 100 kHz, T _A = +25°C		200		μV
RR	Ripple Rejection	f = 120 Hz, ΔV _I = 10 V	54	60		dB
V _D	Dropout Voltage	T _J = +25°C, I _O = 1 A		2		V
I _{SC}	Short-Circuit Current	T _J = +25°C, V _I = -35 V		300		mA
I _{PK}	Peak Current	T _J = +25°C		2.2		A

Note:

8. Load and line regulation are specified at constant junction temperature. Changes in V_O due to heating effects must be taken into account separately. Pulse testing with low duty is used.

Electrical Characteristics (KA7915 / LM7915)(V_I = -23 V, I_O = 500 mA, 0°C ≤ T_J ≤ +125°C, C_I = 2.2 μF, C_O = 1 μF; unless otherwise specified.)

Symbol	Parameter	Conditions	Min.	Typ.	Max.	Unit
V _O	Output Voltage	T _J = +25°C	-14.40	-15.00	-15.60	V
		I _O = 5 mA to 1 A, P _O ≤ 15 W V _I = -18 V to -30 V	-14.25	-15.00	-15.75	
ΔV _O	Line Regulation ⁽⁹⁾	T _J = +25°C	V _I = -17.5 V to -30 V	12	300	mV
			V _I = -20 V to -26 V	6	150	
ΔV _O	Load Regulation ⁽⁹⁾	T _J = +25°C, I _O = 5 mA to 1.5 A		12	300	mV
		T _J = +25°C, I _O = 250 mA to 750 mA		4	150	
I _Q	Quiescent Current	T _J = +25°C		3	6	mA
ΔI _Q	Quiescent Current Change	I _O = 5 mA to 1 A		0.05	0.50	mA
		V _I = -17.5 V to -30 V		0.10	1.00	
ΔV _O /ΔT	Temperature Coefficient of V _D	I _O = 5 mA		-0.9		mV/°C
V _N	Output Noise Voltage	f = 10 Hz to 100 kHz, T _A = +25°C		250		μV
RR	Ripple Rejection	f = 120 Hz, ΔV _I = 10 V	54	60		dB
V _D	Dropout Voltage	T _J = +25°C, I _O = 1 A		2		V
I _{SC}	Short-Circuit Current	T _J = +25°C, V _I = -35 V		300		mA
I _{PK}	Peak Current	T _J = +25°C		2.2		A

Note:

9. Load and line regulation are specified at constant junction temperature. Changes in V_O due to heating effects must be taken into account separately. Pulse testing with low duty is used.

Electrical Characteristics (KA7918 / LM7918)(V_I = -27 V, I_O = 500 mA, 0°C ≤ T_J ≤ +125°C, C_I = 2.2 μF, C_O = 1 μF, unless otherwise specified.)

Symbol	Parameter	Conditions	Min.	Typ.	Max.	Unit
V _O	Output Voltage	T _J = +25°C	-17.3	-18.0	-18.7	V
		I _O = 5 mA to 1 A, P _O ≤ 15 W V _I = -22.5 V to -33 V	-17.1	-18.0	-18.9	
ΔV _O	Line Regulation ⁽¹⁰⁾	T _J = +25°C	V _I = -21 V to -33 V	15	360	mV
			V _I = -24 V to -30 V	8	180	
ΔV _O	Load Regulation ⁽¹⁰⁾	T _J = +25°C, I _O = 5 mA to 1.5 A		15	360	mV
		T _J = +25°C, I _O = 250 mA to 750 mA		5	180	
I _Q	Quiescent Current	T _J = +25°C		3	6	mA
ΔI _Q	Quiescent Current Change	I _O = 5 mA to 1 A		0.05	0.50	mA
		V _I = -21 V to -33 V		0.10	1.00	
ΔV _O /ΔT	Temperature Coefficient of V _D	I _O = 5 mA		-1		mV/°C
V _N	Output Noise Voltage	f = 10 Hz to 100 kHz, T _A = +25°C		300		μV
RR	Ripple Rejection	f = 120 Hz, ΔV _I = 10 V		54	60	dB
V _D	Dropout Voltage	T _J = +25°C, I _O = 1 A		2		V
I _{SC}	Short-Circuit Current	T _J = +25°C, V _I = -35 V		300		mA
I _{PK}	Peak Current	T _J = +25°C		2.2		A

Note:

10. Load and line regulation are specified at constant junction temperature. Changes in V_O due to heating effects must be taken into account separately. Pulse testing with low duty is used.

Electrical Characteristics (KA7924)(V_I = -33 V, I_O = 500 mA, 0°C ≤ T_J ≤ +125°C, C_I = 2.2 μF, C_O = 1 μF; unless otherwise specified.)

Symbol	Parameter	Conditions	Min.	Typ.	Max.	Unit
V _O	Output Voltage	T _J = +25°C	-23.0	-24.0	-25.0	V
		I _O = 5 mA to 1 A, P _O ≤ 15 W, V _I = -27 V to -38 V	-22.8	-24.0	-25.2	
ΔV _O	Line Regulation ⁽¹¹⁾	T _J = +25°C	V _I = -27 V to -38 V	15	480	mV
			V _I = -30 V to -36 V	8	180	
ΔV _O	Load Regulation ⁽¹¹⁾	T _J = +25°C, I _O = 5 mA to 1.5 A		15	480	mV
		T _J = +25°C, I _O = 250 mA to 750 mA		5	240	
I _Q	Quiescent Current	T _J = +25°C		3	6	mA
ΔI _Q	Quiescent Current Change	I _O = 5 mA to 1 A		0.05	0.50	mA
		V _I = -27 V to -38 V		0.10	1.00	
ΔV _O /ΔT	Temperature Coefficient of V _D	I _O = 5 mA		-1		mV/°C
V _N	Output Noise Voltage	f = 10 Hz to 100 kHz, T _A = +25°C		400		μV
RR	Ripple Rejection	f = 120 Hz, ΔV _I = 10 V		54	60	dB
V _D	Dropout Voltage	T _J = +25°C, I _O = 1 A		2		V
I _{SC}	Short-Circuit Current	T _J = +25°C, V _I = -35 V		300		mA
I _{PK}	Peak Current	T _J = +25°C		2.2		A

Note:

11. Load and line regulation are specified at constant junction temperature. Changes in V_O due to heating effects must be taken into account separately. Pulse testing with low duty is used.

Electrical Characteristics (KA7912A)(V_I = -19 V, I_O = 500 mA, 0°C ≤ T_J ≤ +125°C, C_I = 2.2 μF, C_O = 1 μF; unless otherwise specified.)

Symbol	Parameter	Conditions	Min.	Typ.	Max.	Unit
V _O	Output Voltage	T _J = +25°C	-11.75	-12.00	-12.25	V
		I _O = 5 mA to 1 A, P _O ≤ 15 W, V _I = -15.5 V to -27 V	-11.50	-12.00	-12.50	
ΔV _O	Line Regulation ⁽¹²⁾	T _J = +25°C	V _I = -14.5 V to -27 V, I _O = 1 A	12	120	mV
			V _I = -16 V to -22 V, I _O = 1 A	6	60	
		V _I = -14.8 V to -30 V	12	120		
		V _I = -16 V to -22 V, I _O = 1 A	12	120		
ΔV _O	Load Regulation ⁽¹²⁾	T _J = +25°C, I _O = 5 mA to 1.5 A		12	150	mV
		T _J = +25°C, I _O = 250 mA to 750 mA		4	75	
I _Q	Quiescent Current	T _J = +25°C		3	6	mA
ΔI _Q	Quiescent Current Change	I _O = 5 mA to 1 A		0.05	0.50	mA
		V _I = -15 V to -30 V		0.10	1.00	
ΔV _O /ΔT	Temperature Coefficient of V _D	I _O = 5 mA		-0.8		mV/°C
V _N	Output Noise Voltage	f = 10 Hz to 100 kHz, T _A = +25°C		200		μV
RR	Ripple Rejection	f = 120 Hz, ΔV _I = 10 V	54	60		dB
V _D	Dropout Voltage	T _J = +25°C, I _O = 1 A		2		V
I _{SC}	Short-Circuit Current	T _J = +25°C, V _I = -35 V		300		mA
I _{PK}	Peak Current	T _J = +25°C		2.2		A

Note:

12. Load and line regulation are specified at constant junction temperature. Changes in V_O due to heating effects must be taken into account separately. Pulse testing with low duty is used.

Electrical Characteristics (KA7915A)(V_I = -23 V, I_O = 500 mA, 0°C ≤ T_J ≤ +125°C, C_I = 2.2 μF, C_O = 1 μF; unless otherwise specified.)

Symbol	Parameter	Conditions	Min.	Typ.	Max.	Unit	
V _O	Output Voltage	T _J = +25°C	-14.7	-15.0	-15.3	V	
		I _O = 5 mA to 1 A, P _O ≤ 15 W, V _I = -18 V to -30 V	-14.4	-15.0	-15.6		
ΔV _O	Line Regulation ⁽¹³⁾	T _J = +25°C	V _I = -17.5 V to -30 V, I _O = 1 A		12	150	mV
			V _I = -20 V to -26 V, I _O = 1 A		6	75	
		V _I = -17.9 V to -30 V		12	150		
		V _I = -20 V to -26 V, I _O = 1 A		6	150		
ΔV _O	Load Regulation ⁽¹³⁾	T _J = +25°C, I _O = 5 mA to 1.5 A		12	150	mV	
		T _J = +25°C, I _O = 250 mA to 750 mA		4	75		
I _Q	Quiescent Current	T _J = +25°C		3	6	mA	
ΔI _Q	Quiescent Current Change	I _O = 5 mA to 1 A		0.05	0.50	mA	
		V _I = -18.5 V to -30 V		0.10	1.00		
ΔV _O /ΔT	Temperature Coefficient of V _D	I _O = 5 mA		-0.9		mV/°C	
V _N	Output Noise Voltage	f = 10 Hz to 100 kHz, T _A = +25°C		250		μV	
RR	Ripple Rejection	f = 120 Hz, ΔV _I = 10 V	54	60		dB	
V _D	Dropout Voltage	T _J = +25°C, I _O = 1 A		2		V	
I _{SC}	Short-Circuit Current	T _J = +25°C, V _I = -35 V		300		mA	
I _{PK}	Peak Current	T _J = +25°C		2.2		A	

Note:

13. Load and line regulation are specified at constant junction temperature. Changes in V_O due to heating effects must be taken into account separately. Pulse testing with low duty is used.

Typical Performance Characteristics

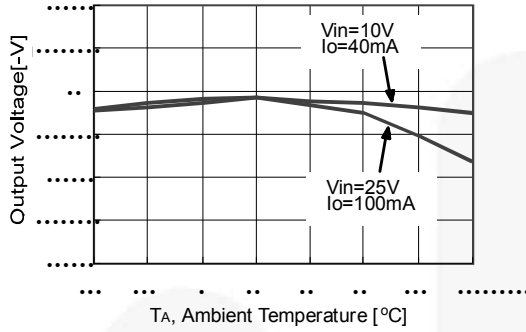

Figure 2. Output Voltage

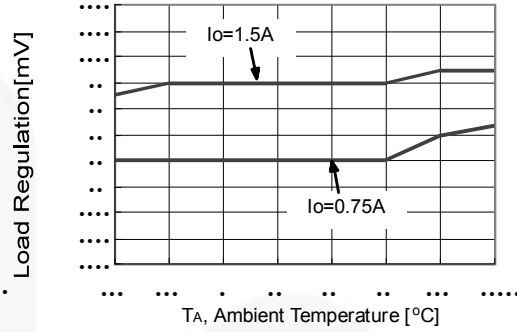

Figure 3. Load Regulation

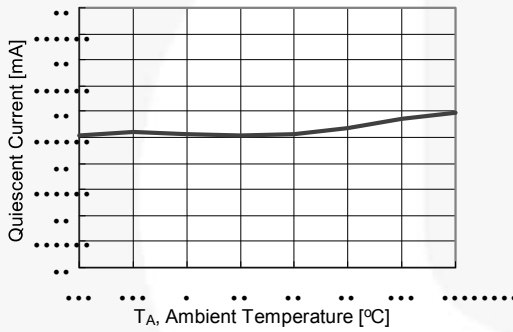

Figure 4. Quiescent Current

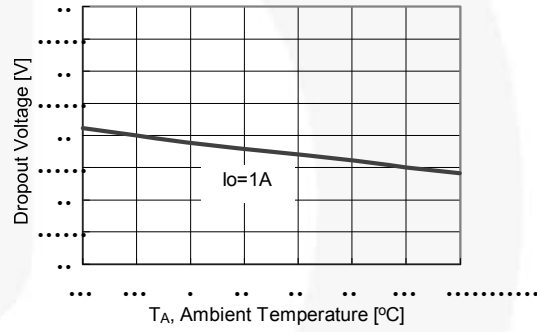

Figure 5. Dropout Voltage

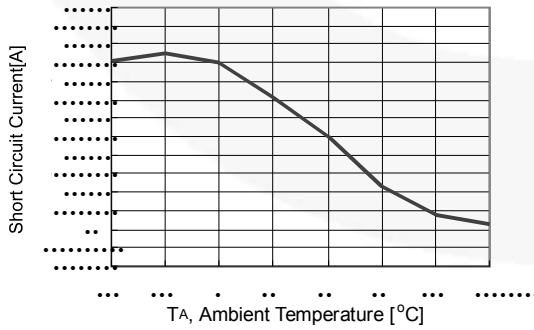

Figure 6. Short-Circuit Current

Typical Applications

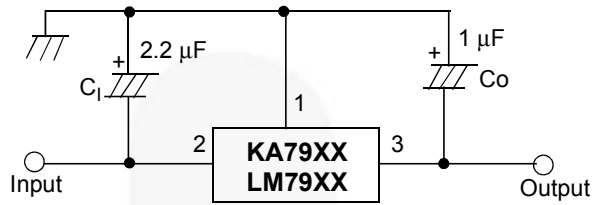

Figure 7. Negative Fixed Output Regulator

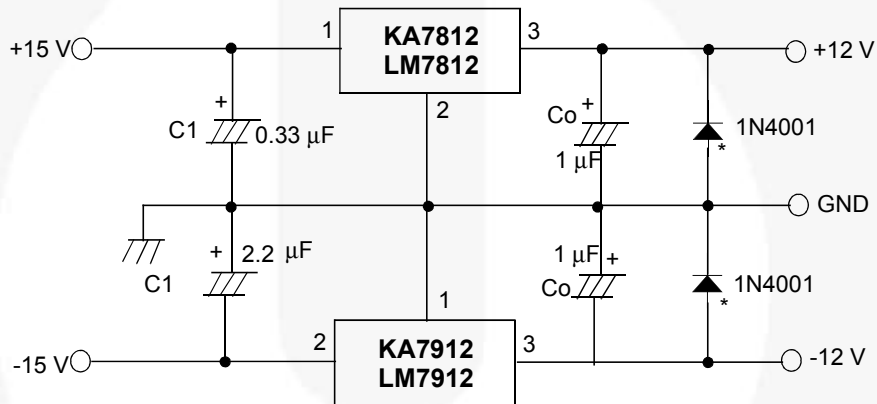

Figure 8. Split Power Supply (• 12 V / 1 A)

Notes:

14. To specify an output voltage, substitute voltage value for "XX".
15. C_1 is required if the regulator is located an appreciable distance from the power supply filter. For value given, capacitor must be solid tantalum. If aluminium electronics are used, at least ten times the value shown should be selected.
16. C_O improves stability and transient response. If large capacitors are used, a high-current diode from input to output (1N4001 or similar) should be introduced to protect the device from momentary input short circuit.

Physical Dimensions

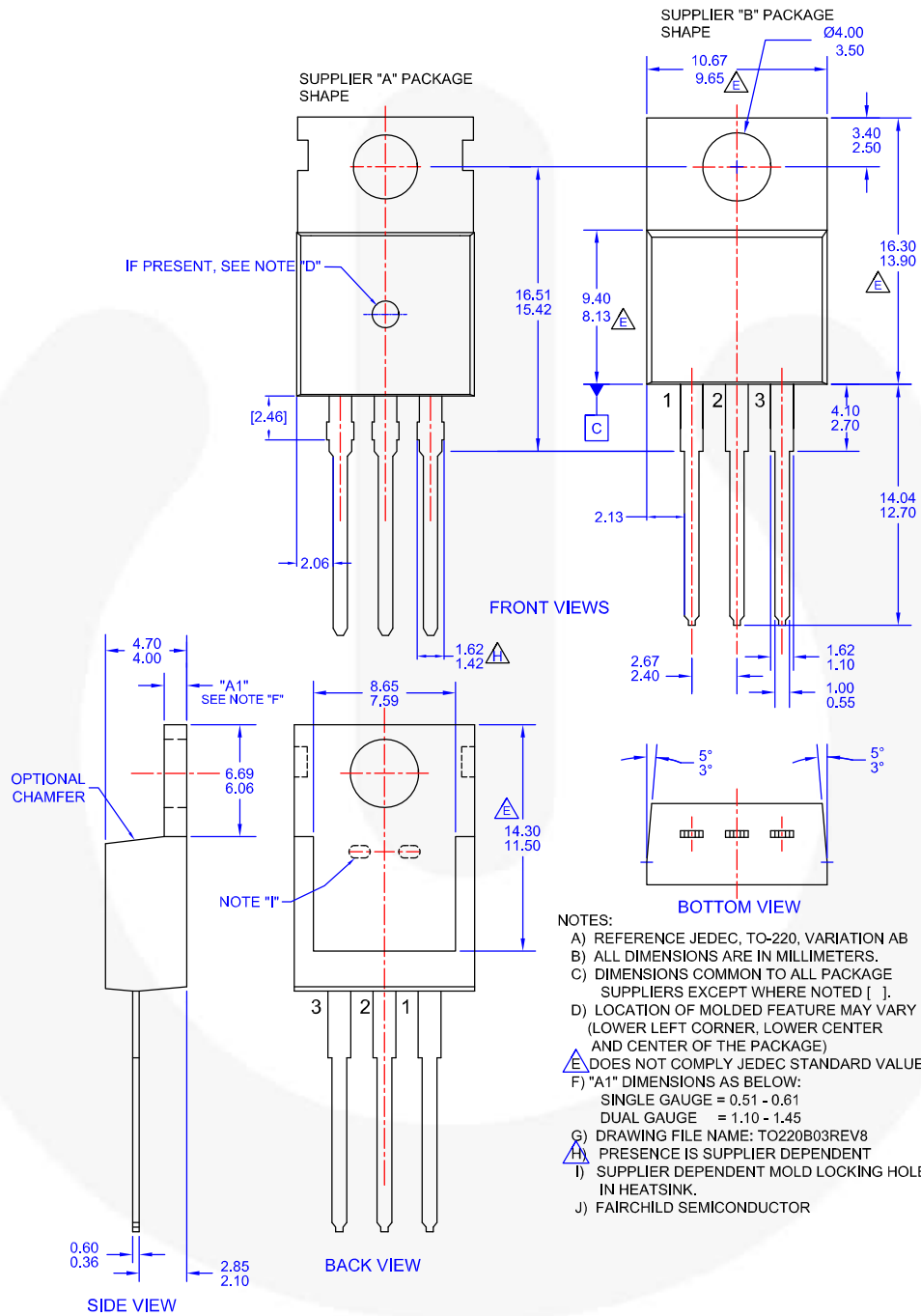

Figure 9. TO-220, MOLDED, 3-LEAD, JEDEC VARIATION AB (ACTIVE)



TRADEMARKS

The following includes registered and unregistered trademarks and service marks, owned by Fairchild Semiconductor and/or its global subsidiaries, and is not intended to be an exhaustive list of all such trademarks.

AccuPower™	F-PFS™		
Awinda®	FRFET®	PowerTrench®	TinyBoost®
AX-CAP®*	Global Power Resource™	PowerXS™	TinyBuck®
BitSiC™	GreenBridge™	Programmable Active Droop™	TinyCalc™
Build it Now™	Green FPS™	QFET®	TinyLogic®
CorePLUS™	Green FPS™ e-Series™	QS™	TINYOPTO™
CorePOWER™	Gmax™	Quiet Series™	TinyPower™
CROSSVOLT™	GTO™	RapidConfigure™	TinyPWM™
CTL™	IntelliMAX™		TinyWire™
Current Transfer Logic™	ISOPLANAR™	Saving our world, 1mW/W/kW at a time™	TranSiC™
DEUXPEED®	Making Small Speakers Sound Louder and Better™	SignalWise™	TriFault Detect™
Dual Cool™	MegaBuck™	SmartMax™	TRUECURRENT®*
EcoSPARK®	MICROCOUPLER™	SMART START™	μSerDes™
EfficientMax™	MicroFET™	Solutions for Your Success™	
ESBC™	MicroPak™	SPM®	UHC®
	MicroPak2™	STEALTH™	Ultra FRFET™
Fairchild®	MillerDrive™	SuperFET®	UniFET™
Fairchild Semiconductor®	MotionMax™	SuperSOT™-3	VCX™
FACT Quiet Series™	MotionGrid®	SuperSOT™-6	VisualMax™
FACT®	MTI®	SuperSOT™-8	VoltagePlus™
FAST®	MTx®	SupreMOS®	XS™
FastvCore™	MVN®	SyncFET™	Xsens™
FETBench™	mWSaver®	Sync-Lock™	仙童™
FPS™	OptoHiT™		

* Trademarks of System General Corporation, used under license by Fairchild Semiconductor.

DISCLAIMER

FAIRCHILD SEMICONDUCTOR RESERVES THE RIGHT TO MAKE CHANGES WITHOUT FURTHER NOTICE TO ANY PRODUCTS HEREIN TO IMPROVE RELIABILITY, FUNCTION, OR DESIGN. TO OBTAIN THE LATEST, MOST UP-TO-DATE DATASHEET AND PRODUCT INFORMATION, VISIT OUR WEBSITE AT [HTTP://WWW.FAIRCHILDSEMI.COM](http://www.fairchildsemi.com). FAIRCHILD DOES NOT ASSUME ANY LIABILITY ARISING OUT OF THE APPLICATION OR USE OF ANY PRODUCT OR CIRCUIT DESCRIBED HEREIN; NEITHER DOES IT CONVEY ANY LICENSE UNDER ITS PATENT RIGHTS, NOR THE RIGHTS OF OTHERS. THESE SPECIFICATIONS DO NOT EXPAND THE TERMS OF FAIRCHILD'S WORLDWIDE TERMS AND CONDITIONS, SPECIFICALLY THE WARRANTY THEREIN, WHICH COVERS THESE PRODUCTS.

LIFE SUPPORT POLICY

FAIRCHILD'S PRODUCTS ARE NOT AUTHORIZED FOR USE AS CRITICAL COMPONENTS IN LIFE SUPPORT DEVICES OR SYSTEMS WITHOUT THE EXPRESS WRITTEN APPROVAL OF FAIRCHILD SEMICONDUCTOR CORPORATION.

As used herein:

1. Life support devices or systems are devices or systems which, (a) are intended for surgical implant into the body or (b) support or sustain life, and (c) whose failure to perform when properly used in accordance with instructions for use provided in the labeling, can be reasonably expected to result in a significant injury of the user.
2. A critical component in any component of a life support, device, or system whose failure to perform can be reasonably expected to cause the failure of the life support device or system, or to affect its safety or effectiveness.

ANTI-COUNTERFEITING POLICY

Fairchild Semiconductor Corporation's Anti-Counterfeiting Policy. Fairchild's Anti-Counterfeiting Policy is also stated on our external website, www.fairchildsemi.com, under Sales Support.

Counterfeiting of semiconductor parts is a growing problem in the industry. All manufacturers of semiconductor products are experiencing counterfeiting of their parts. Customers who inadvertently purchase counterfeit parts experience many problems such as loss of brand reputation, substandard performance, failed applications, and increased cost of production and manufacturing delays. Fairchild is taking strong measures to protect ourselves and our customers from the proliferation of counterfeit parts. Fairchild strongly encourages customers to purchase Fairchild parts either directly from Fairchild or from Authorized Fairchild Distributors who are listed by country on our web page cited above. Products customers buy either from Fairchild directly or from Authorized Fairchild Distributors are genuine parts, have full traceability, meet Fairchild's quality standards for handling and storage and provide access to Fairchild's full range of up-to-date technical and product information. Fairchild and our Authorized Distributors will stand behind all warranties and will appropriately address any warranty issues that may arise. Fairchild will not provide any warranty coverage or other assistance for parts bought from Unauthorized Sources. Fairchild is committed to combat this global problem and encourage our customers to do their part in stopping this practice by buying direct or from authorized distributors.

PRODUCT STATUS DEFINITIONS

Definition of Terms

Datasheet Identification	Product Status	Definition
Advance Information	Formative / In Design	Datasheet contains the design specifications for product development. Specifications may change in any manner without notice.
Preliminary	First Production	Datasheet contains preliminary data; supplementary data will be published at a later date. Fairchild Semiconductor reserves the right to make changes at any time without notice to improve design.
No Identification Needed	Full Production	Datasheet contains final specifications. Fairchild Semiconductor reserves the right to make changes at any time without notice to improve the design.
Obsolete	Not In Production	Datasheet contains specifications on a product that is discontinued by Fairchild Semiconductor. The datasheet is for reference information only.

ON Semiconductor and  are trademarks of Semiconductor Components Industries, LLC dba ON Semiconductor or its subsidiaries in the United States and/or other countries. ON Semiconductor owns the rights to a number of patents, trademarks, copyrights, trade secrets, and other intellectual property. A listing of ON Semiconductor's product/patent coverage may be accessed at www.onsemi.com/site/pdf/Patent-Marking.pdf. ON Semiconductor reserves the right to make changes without further notice to any products herein. ON Semiconductor makes no warranty, representation or guarantee regarding the suitability of its products for any particular purpose, nor does ON Semiconductor assume any liability arising out of the application or use of any product or circuit, and specifically disclaims any and all liability, including without limitation special, consequential or incidental damages. Buyer is responsible for its products and applications using ON Semiconductor products, including compliance with all laws, regulations and safety requirements or standards, regardless of any support or applications information provided by ON Semiconductor. "Typical" parameters which may be provided in ON Semiconductor data sheets and/or specifications can and do vary in different applications and actual performance may vary over time. All operating parameters, including "Typicals" must be validated for each customer application by customer's technical experts. ON Semiconductor does not convey any license under its patent rights nor the rights of others. ON Semiconductor products are not designed, intended, or authorized for use as a critical component in life support systems or any FDA Class 3 medical devices or medical devices with a same or similar classification in a foreign jurisdiction or any devices intended for implantation in the human body. Should Buyer purchase or use ON Semiconductor products for any such unintended or unauthorized application, Buyer shall indemnify and hold ON Semiconductor and its officers, employees, subsidiaries, affiliates, and distributors harmless against all claims, costs, damages, and expenses, and reasonable attorney fees arising out of, directly or indirectly, any claim of personal injury or death associated with such unintended or unauthorized use, even if such claim alleges that ON Semiconductor was negligent regarding the design or manufacture of the part. ON Semiconductor is an Equal Opportunity/Affirmative Action Employer. This literature is subject to all applicable copyright laws and is not for resale in any manner.

PUBLICATION ORDERING INFORMATION

LITERATURE FULFILLMENT:



Literature Distribution Center for ON Semiconductor
19521 E. 32nd Pkwy, Aurora, Colorado 80011 USA
Phone: 303-675-2175 or 800-344-3860 Toll Free USA/Canada
Fax: 303-675-2176 or 800-344-3867 Toll Free USA/Canada
Email: orderlit@onsemi.com

N. American Technical Support: 800-282-9855 Toll Free
USA/Canada
Europe, Middle East and Africa Technical Support:
Phone: 421 33 790 2910
Japan Customer Focus Center
Phone: 81-3-5817-1050

ON Semiconductor Website: www.onsemi.com
Order Literature: <http://www.onsemi.com/orderlit>
For additional information, please contact your local
Sales Representative

Looking for pricing, stock, or lifecycle information?

Click below to explore more details on WIN SOURCE:

-  [View KA7915ATU on WIN SOURCE](#)
-  [Fairchild/ON Semiconductor](#) Information

Optimize Your Supply Chain with WIN SOURCE Solutions

-  Global Sourcing Solution
-  Obsolete Management
-  Cost Control Management
-  Shortage Management
-  Alternative Solution
-  Excess Inventory Management