



**THE DATASHEET OF
LM2678SDX-ADJ/NOPB**



LM2678 SIMPLE SWITCHER® High Efficiency 5-A Step-Down Voltage Regulator

1 Features

- Efficiency Up to 92%
- Simple and Easy to Design Using Off-the-Shelf External Components
- 120-mΩ DMOS Output Switch
- 3.3-V, 5-V, and 12-V Fixed Output and Adjustable (1.2 V to 37 V) Versions
- 50-μA Standby Current When Switched OFF
- ±2% Maximum Output Tolerance Over Full Line and Load Conditions
- Wide Input Voltage Range: 8 V to 40 V
- 260-kHz Fixed Frequency Internal Oscillator
- –40 to 125°C Operating Junction Temperature Range
- Create a Custom Design Using the LM2678 With the [WEBENCH® Power Designer](#)

2 Applications

- Simple-to-Design, High Efficiency (>90%) Step-Down Switching Regulators
- Efficient System Preregulator for Linear Voltage Regulators
- Battery Chargers

3 Description

The LM2678 series of regulators are monolithic integrated circuits which provide all of the active functions for a step-down (buck) switching regulator capable of driving up to 5-A loads with excellent line and load regulation characteristics. High efficiency (>90%) is obtained through the use of a low ON-resistance DMOS power switch. The series consists of fixed output voltages of 3.3 V, 5 V, and 12 V and an adjustable output version.

The SIMPLE SWITCHER® concept provides for a complete design using a minimum number of external components. A high fixed frequency oscillator (260 kHz) allows the use of physically smaller sized components. A family of standard inductors for use with the LM2678 are available from several manufacturers to greatly simplify the design process.

The LM2678 series also has built-in thermal shutdown, current limiting, and an ON/OFF control input that can power down the regulator to a low 50-μA quiescent current standby condition. The output voltage is ensured to a ±2% tolerance. The clock frequency is controlled to within a ±11% tolerance.

Device Information⁽¹⁾

| PART NUMBER | PACKAGE | BODY SIZE (NOM) |
|-------------|------------|----------------------|
| LM2678 | TO-263 (7) | 10.10 mm × 8.89 mm |
| | TO-220 (7) | 14.986 mm × 10.16 mm |
| | VSON (14) | 6.00 mm × 5.00 mm |

(1) For all available packages, see the orderable addendum at the end of the data sheet.

Typical Application

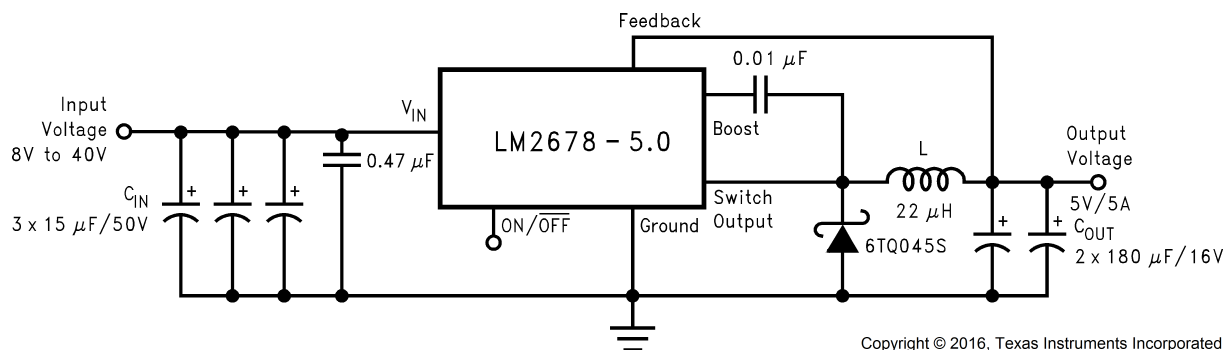

Table of Contents

| | | | |
|--|-----------|--|-----------|
| 1 Features | 1 | 7.3 Feature Description | 10 |
| 2 Applications | 1 | 7.4 Device Functional Modes | 11 |
| 3 Description | 1 | 8 Application and Implementation | 12 |
| 4 Revision History | 2 | 8.1 Application Information | 12 |
| 5 Pin Configuration and Functions | 3 | 8.2 Typical Application | 14 |
| 6 Specifications | 4 | 9 Power Supply Recommendations | 26 |
| 6.1 Absolute Maximum Ratings | 4 | 10 Layout | 26 |
| 6.2 ESD Ratings | 4 | 10.1 Layout Guidelines | 26 |
| 6.3 Recommended Operating Conditions | 4 | 10.2 Layout Example | 27 |
| 6.4 Thermal Information | 5 | 11 Device and Documentation Support | 28 |
| 6.5 Electrical Characteristics – 3.3 V | 5 | 11.1 Custom Design With WEBENCH® Tools | 28 |
| 6.6 Electrical Characteristics – 5 V | 5 | 11.2 Related Documentation | 28 |
| 6.7 Electrical Characteristics – 12 V | 6 | 11.3 Receiving Notification of Documentation Updates | 28 |
| 6.8 Electrical Characteristics – Adjustable | 6 | 11.4 Community Resources | 28 |
| 6.9 Electrical Characteristics – All Output Voltage Versions | 6 | 11.5 Trademarks | 28 |
| 6.10 Typical Characteristics | 7 | 11.6 Electrostatic Discharge Caution | 28 |
| 7 Detailed Description | 10 | 11.7 Glossary | 28 |
| 7.1 Overview | 10 | 12 Mechanical, Packaging, and Orderable Information | 29 |
| 7.2 Functional Block Diagram | 10 | 12.1 VSON Package Devices | 29 |

4 Revision History

NOTE: Page numbers for previous revisions may differ from page numbers in the current version.

| Changes from Revision J (June 2016) to Revision K | Page |
|--|-------------|
| • Deleted RADJ = 5.6 kΩ | 6 |
| • Deleted and updated with new values for Min, Typ and Max | 6 |
| • Deleted and updated with new values for Min and Max | 6 |
| • Changed soft-start pin to ON/OFF pin | 6 |
| • Changed to 200 μA from 1.5 mA | 6 |
| • Changed typ and max values to 16 and 15 mA | 6 |

| Changes from Revision I (April 2013) to Revision J | Page |
|--|-------------|
| • Added <i>ESD Ratings</i> table, <i>Feature Description</i> section, <i>Device Functional Modes</i> , <i>Application and Implementation</i> section, <i>Power Supply Recommendations</i> section, <i>Layout</i> section, <i>Device and Documentation Support</i> section, and <i>Mechanical, Packaging, and Orderable Information</i> section. | 1 |
| • Removed all references to Computer Design Software LM267X Made Simple (Version 6.0) | 1 |

| Changes from Revision H (April 2013) to Revision I | Page |
|--|-------------|
| • Changed layout of National Data Sheet to TI format | 29 |

5 Pin Configuration and Functions

**KTW Package
7-Pin TO-263
Top View**

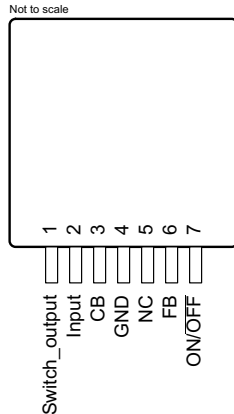

**NDZ Package
7-Pin TO-220
Top View**

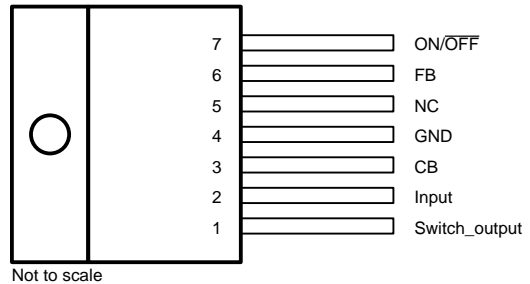

**NHM Package
14-Pin VSON
Top View**

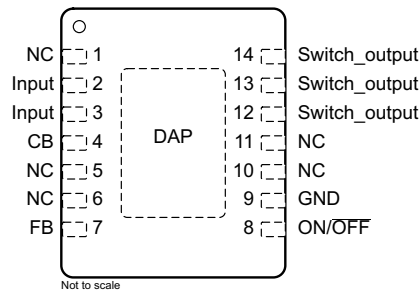

DAP connect to pin 9

Pin Functions

| NAME | PIN | | I/O | DESCRIPTION |
|---------------|----------------|-----------------|-----|---|
| | TO-263, TO-220 | VSON | | |
| Switch output | 1 | 12, 13, 14 | O | Source pin of the internal high-side FET. This is a switching node. Attached this pin to an inductor and the cathode of the external diode. |
| Input | 2 | 2, 3 | I | Supply input pin to collector pin of high-side FET. Connect to power supply and input bypass capacitors C_{IN} . Path from V_{IN} pin to high frequency bypass C_{IN} and GND must be as short as possible. |
| CB | 3 | 4 | I | Boot-strap capacitor connection for high-side driver. Connect a high-quality 100-nF capacitor from CB to VSW Pin. |
| GND | 4 | 9 | — | Power ground pins. Connect to system ground. Ground pins of C_{IN} and C_{OUT} . Path to C_{IN} must be as short as possible. |
| FB | 6 | 7 | I | Feedback sense input pin. Connect to the midpoint of feedback divider to set V_{OUT} for ADJ version or connect this pin directly to the output capacitor for a fixed output version. |
| ON/OFF | 7 | 8 | I | Enable input to the voltage regulator. High = ON and low = OFF. Pull this pin high or float to enable the regulator. |
| NC | 5 | 1, 5, 6, 10, 11 | — | No connect pins. |

6 Specifications

6.1 Absolute Maximum Ratings

over operating free-air temperature range (unless otherwise noted)⁽¹⁾⁽²⁾

| | | MIN | MAX | UNIT |
|---|--------------------|--------------------|---------------------|------|
| Input supply voltage | | | 45 | V |
| Soft-start pin voltage | | -0.1 | 6 | V |
| Switch voltage to ground ⁽³⁾ | | -1 | V _{IN} | V |
| Boost pin voltage | | | V _{SW} + 8 | V |
| Feedback pin voltage | | -0.3 | 14 | V |
| Power dissipation | | Internally limited | | |
| Soldering temperature | Wave (4 s) | | 260 | °C |
| | Infrared (10 s) | | 240 | |
| | Vapor phase (75 s) | | 219 | |
| Storage temperature, T _{stg} | | -65 | 150 | °C |

- (1) Stresses beyond those listed under *Absolute Maximum Ratings* may cause permanent damage to the device. These are stress ratings only, which do not imply functional operation of the device at these or any other conditions beyond those indicated under *Recommended Operating Conditions*. Exposure to absolute-maximum-rated conditions for extended periods may affect device reliability.
- (2) If Military/Aerospace specified devices are required, please contact the Texas Instruments Sales Office/Distributors for availability and specifications.
- (3) The absolute maximum specification of the *Switch Voltage to Ground* applies to DC voltage. An extended negative voltage limit of -10 V applies to a pulse of up to 20 ns, -6 V of 60 ns and -3 V of up to 100 ns.

6.2 ESD Ratings

| | | VALUE | UNIT |
|--------------------|-------------------------|--|------------|
| V _(ESD) | Electrostatic discharge | Human-body model (HBM), per ANSI/ESDA/JEDEC JS-001 ⁽¹⁾⁽²⁾ | ±2000 V |

- (1) JEDEC document JEP155 states that 500-V HBM allows safe manufacturing with a standard ESD control process.
- (2) ESD was applied using the human-body model, a 100-pF capacitor discharged through a 1.5-kΩ resistor into each pin.

6.3 Recommended Operating Conditions

| | | MIN | MAX | UNIT |
|--------------------------------------|--|-----|-----|------|
| Supply voltage | | 8 | 40 | V |
| Junction temperature, T _J | | -40 | 125 | °C |

6.4 Thermal Information

| THERMAL METRIC ⁽¹⁾ | | LM2678 | | | UNIT | |
|-------------------------------|---|--------------------|--------------|------------|------|------|
| | | NDZ (TO-220) | KTW (TO-263) | NHM (VSON) | | |
| | | 7 PINS | 7 PINS | 14 PINS | | |
| R _{θJA} | Junction-to-ambient thermal resistance | See ⁽²⁾ | 65 | — | — | °C/W |
| | | See ⁽³⁾ | 45 | — | — | |
| | | See ⁽⁴⁾ | — | 56 | — | |
| | | See ⁽⁵⁾ | — | 35 | — | |
| | | See ⁽⁶⁾ | — | 26 | — | |
| | | See ⁽⁷⁾ | — | — | 55 | |
| | | See ⁽⁸⁾ | — | — | 29 | |
| R _{θJC(top)} | Junction-to-case (top) thermal resistance | | 2 | 2 | — | °C/W |

- (1) For more information about traditional and new thermal metrics, see the [Semiconductor and IC Package Thermal Metrics](#) application report.
- (2) Junction to ambient thermal resistance (no external heat sink) for the 7-lead TO-220 package mounted vertically, with ½ inch leads in a socket, or on a PCB with minimum copper area.
- (3) Junction to ambient thermal resistance (no external heat sink) for the 7-lead TO-220 package mounted vertically, with ½ inch leads soldered to a PCB containing approximately 4 square inches of (1 oz.) copper area surrounding the leads.
- (4) Junction to ambient thermal resistance for the 7-lead DDPAK mounted horizontally against a PCB area of 0.136 square inches (the same size as the DDPAK package) of 1 oz. (0.0014 in. thick) copper.
- (5) Junction to ambient thermal resistance for the 7-lead DDPAK mounted horizontally against a PCB area of 0.4896 square inches (3.6 times the area of the DDPAK package) of 1 oz. (0.0014 in. thick) copper.
- (6) Junction to ambient thermal resistance for the 7-lead DDPAK mounted horizontally against a PCB copper area of 1.0064 square inches (7.4 times the area of the DDPAK 3 package) of 1 oz. (0.0014 in. thick) copper. Additional copper area reduces thermal resistance further.
- (7) Junction to ambient thermal resistance for the 14-lead VSON mounted on a PCB copper area equal to the die attach paddle.
- (8) Junction to ambient thermal resistance for the 14-lead VSON mounted on a PCB copper area using 12 vias to a second layer of copper equal to die attach paddle. Additional copper area will reduce thermal resistance further. For layout recommendations, see [AN-1187 Leadless Leadframe Package \(LLP\)](#).

6.5 Electrical Characteristics – 3.3 V

Specifications apply for T_A = T_J = 25°C and R_{ADJ} = 5.6 kΩ (unless otherwise noted).

| PARAMETER | TEST CONDITIONS | MIN ⁽¹⁾ | TYP ⁽²⁾ | MAX ⁽¹⁾ | UNIT | |
|---------------------------------|---|---------------------------------|--------------------|--------------------|-------|---|
| V _{OUT} Output voltage | V _{IN} = 8 V to 40 V, 100 mA ≤ I _{OUT} ≤ 5 A | T _J = 25°C | 3.234 | 3.3 | 3.366 | V |
| | | T _J = –40°C to 125°C | 3.201 | | 3.399 | |
| η Efficiency | V _{IN} = 12 V, I _{LOAD} = 5 A | | 82% | | | |

- (1) All room temperature limits are 100% tested during production with T_A = T_J = 25°C. All limits at temperature extremes are specified through correlation using standard Quality Control (SQC) methods. All limits are used to calculate Average Outgoing Quality Level (AOQL).
- (2) Typical values are determined with T_A = T_J = 25°C and represent the most likely norm.

6.6 Electrical Characteristics – 5 V

Specifications apply for T_A = T_J = 25°C and R_{ADJ} = 5.6 kΩ (unless otherwise noted).

| PARAMETER | TEST CONDITIONS | MIN ⁽¹⁾ | TYP ⁽²⁾ | MAX ⁽¹⁾ | UNIT | |
|---------------------------------|---|---------------------------------|--------------------|--------------------|------|---|
| V _{OUT} Output voltage | V _{IN} = 8 V to 40 V, 100 mA ≤ I _{OUT} ≤ 5 A | T _J = 25°C | 4.9 | 5 | 5.1 | V |
| | | T _J = –40°C to 125°C | 4.85 | | 5.15 | |
| η Efficiency | V _{IN} = 12 V, I _{LOAD} = 5 A | | 84% | | | |

- (1) All room temperature limits are 100% tested during production with T_A = T_J = 25°C. All limits at temperature extremes are specified through correlation using standard Quality Control (SQC) methods. All limits are used to calculate Average Outgoing Quality Level (AOQL).
- (2) Typical values are determined with T_A = T_J = 25°C and represent the most likely norm.

6.7 Electrical Characteristics – 12 V

Specifications apply for $T_A = T_J = 25^\circ\text{C}$ and $R_{ADJ} = 5.6\text{ k}\Omega$ (unless otherwise noted).

| PARAMETER | | TEST CONDITIONS | | MIN ⁽¹⁾ | TYP ⁽²⁾ | MAX ⁽¹⁾ | UNIT |
|-----------|----------------|---|--|--------------------|--------------------|--------------------|------|
| V_{OUT} | Output voltage | $V_{IN} = 15\text{ V to }40\text{ V}$, $100\text{ mA} \leq I_{OUT} \leq 5\text{ A}$ | $T_J = 25^\circ\text{C}$ | 11.76 | 12 | 12.24 | V |
| | | | $T_J = -40^\circ\text{C to }125^\circ\text{C}$ | 11.64 | | 12.36 | |
| η | Efficiency | $V_{IN} = 24\text{ V}$, $I_{LOAD} = 5\text{ A}$ | | | 92% | | |

- (1) All room temperature limits are 100% tested during production with $T_A = T_J = 25^\circ\text{C}$. All limits at temperature extremes are specified through correlation using standard Quality Control (SQC) methods. All limits are used to calculate Average Outgoing Quality Level (AOQL).
- (2) Typical values are determined with $T_A = T_J = 25^\circ\text{C}$ and represent the most likely norm.

6.8 Electrical Characteristics – Adjustable

Specifications apply for $T_A = T_J = 25^\circ\text{C}$ and $R_{ADJ} = 5.6\text{ k}\Omega$ (unless otherwise noted).

| PARAMETER | | TEST CONDITIONS | | MIN ⁽¹⁾ | TYP ⁽²⁾ | MAX ⁽¹⁾ | UNIT |
|-----------|------------------|--|--|--------------------|--------------------|--------------------|------|
| V_{FB} | Feedback voltage | $V_{IN} = 8\text{ V to }40\text{ V}$, $100\text{ mA} \leq I_{OUT} \leq 5\text{ A}$ V_{OUT} programmed for 5 V | $T_J = 25^\circ\text{C}$ | 1.186 | 1.21 | 1.234 | V |
| | | | $T_J = -40^\circ\text{C to }125^\circ\text{C}$ | 1.174 | | 1.246 | |
| η | Efficiency | $V_{IN} = 12\text{ V}$, $I_{LOAD} = 5\text{ A}$ | | | 84% | | |

- (1) All room temperature limits are 100% tested during production with $T_A = T_J = 25^\circ\text{C}$. All limits at temperature extremes are specified through correlation using standard Quality Control (SQC) methods. All limits are used to calculate Average Outgoing Quality Level (AOQL).
- (2) Typical values are determined with $T_A = T_J = 25^\circ\text{C}$ and represent the most likely norm.

6.9 Electrical Characteristics – All Output Voltage Versions

Specifications are for $T_A = T_J = 25^\circ\text{C}$, $V_{IN} = 12\text{ V}$ for the 3.3-V, 5-V, and adjustable versions, and $V_{IN} = 24\text{ V}$ for the 12-V version (unless otherwise noted).

| PARAMETER | | TEST CONDITIONS | | MIN | TYP | MAX | UNIT |
|--------------|---------------------------|---|--|------|------|-------|---------------|
| I_Q | Quiescent current | $V_{FEEDBACK} = 8\text{ V}$ for 3.3-V, 5-V, and adjustable versions, $V_{FEEDBACK} = 15\text{ V}$ for 12-V version | | | 4.2 | 6 | mA |
| I_{STBY} | Standby quiescent current | ON/\overline{OFF} pin = 0 V | $T_J = 25^\circ\text{C}$ | | 50 | 100 | μA |
| | | | $T_J = -40^\circ\text{C to }125^\circ\text{C}$ | | | 150 | |
| I_{CL} | Current limit | | $T_J = 25^\circ\text{C}$ | 6.1 | 7 | 8.3 | A |
| | | | $T_J = -40^\circ\text{C to }125^\circ\text{C}$ | 5.75 | | 8.75 | |
| I_L | Output leakage current | $V_{IN} = 40\text{ V}$, ON/\overline{OFF} pin = 0 V | $V_{SWITCH} = 0\text{ V}$ | | | 200 | μA |
| | | | $V_{SWITCH} = -1\text{ V}$ | | 16 | 15 | mA |
| $R_{DS(ON)}$ | Switch ON-Resistance | $I_{SWITCH} = 5\text{ A}$ | $T_J = 25^\circ\text{C}$ | | 0.12 | 0.14 | Ω |
| | | | $T_J = -40^\circ\text{C to }125^\circ\text{C}$ | | | 0.225 | |
| f_O | Oscillator frequency | Measured at switch pin | $T_J = 25^\circ\text{C}$ | | 260 | | kHz |
| | | | $T_J = -40^\circ\text{C to }125^\circ\text{C}$ | | 225 | 280 | |
| D | Duty cycle | Maximum duty cycle | | | 91% | | |
| | | Minimum duty cycle | | | 0% | | |
| I_{BIAS} | Feedback bias current | $V_{FEEDBACK} = 1.3\text{ V}$ (adjustable version only) | | | 85 | | nA |
| $V_{ON/OFF}$ | ON/OFF threshold voltage | | $T_J = 25^\circ\text{C}$ | | 1.4 | | V |
| | | | $T_J = -40^\circ\text{C to }125^\circ\text{C}$ | 0.8 | | 2 | |
| $I_{ON/OFF}$ | ON/OFF input current | ON/\overline{OFF} input = 0 V | $T_J = 25^\circ\text{C}$ | | 20 | | μA |
| | | | $T_J = -40^\circ\text{C to }125^\circ\text{C}$ | | | 45 | |

6.10 Typical Characteristics

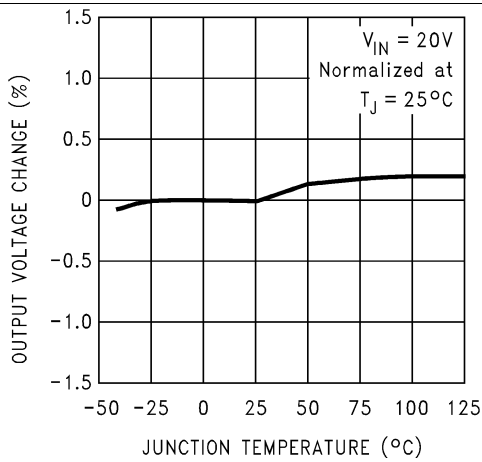

Figure 1. Normalized Output Voltage

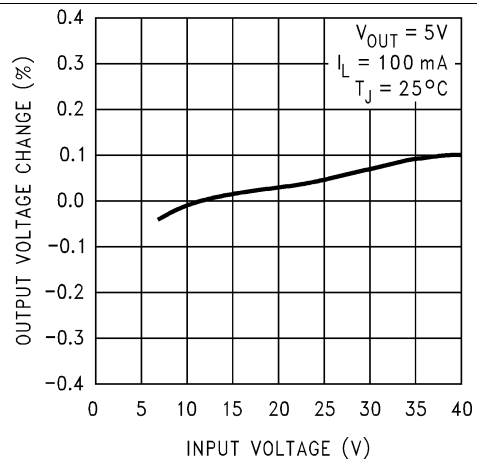

Figure 2. Line Regulation

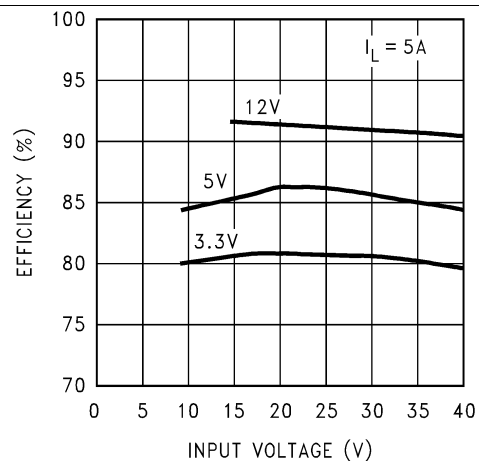

Figure 3. Efficiency vs Input Voltage

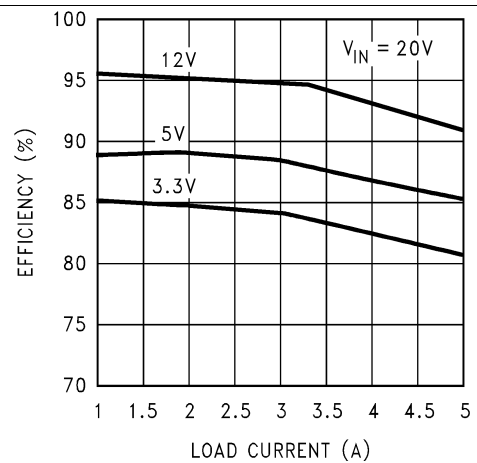

Figure 4. Efficiency vs I_{LOAD}

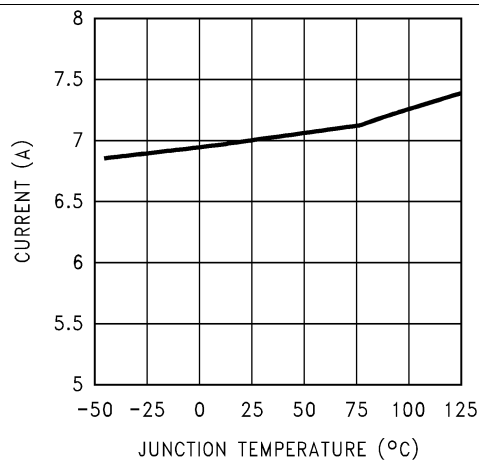

Figure 5. Switch Current Limit

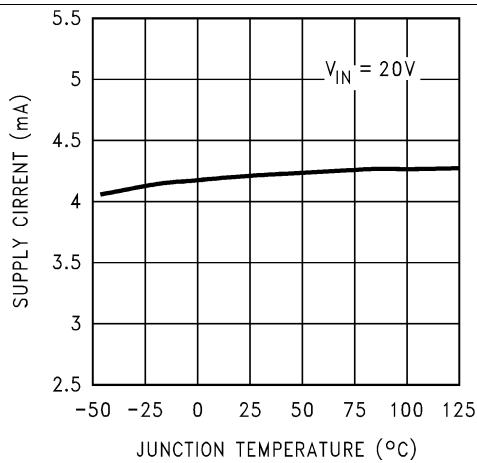

Figure 6. Operating Quiescent Current

Typical Characteristics (continued)

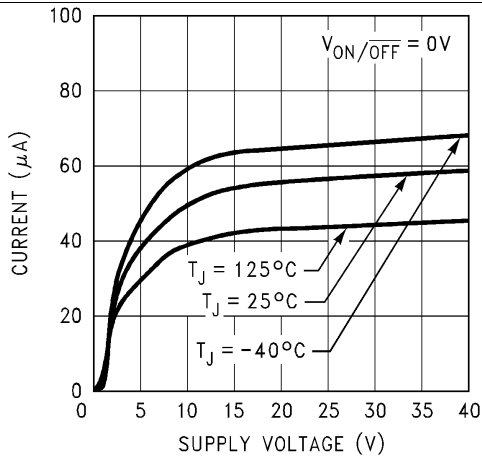

Figure 7. Standby Quiescent Current

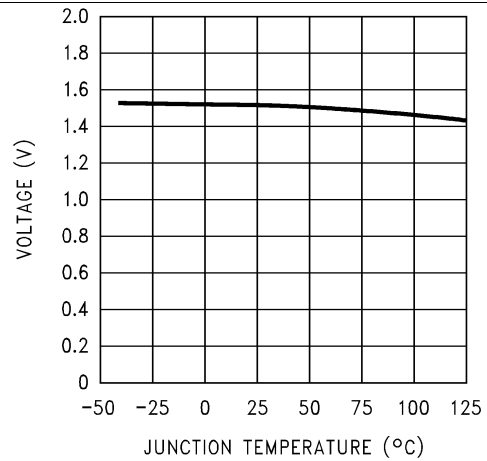

Figure 8. ON/OFF Threshold Voltage

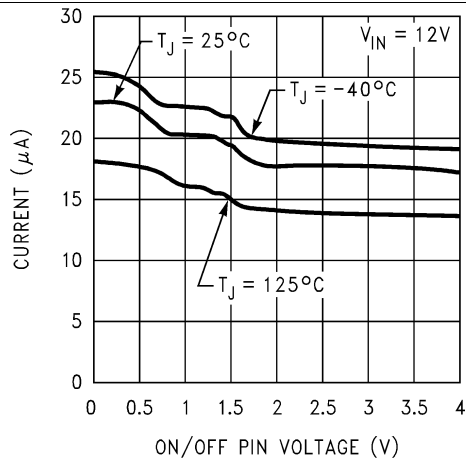

Figure 9. ON/OFF Pin Current (Sourcing)

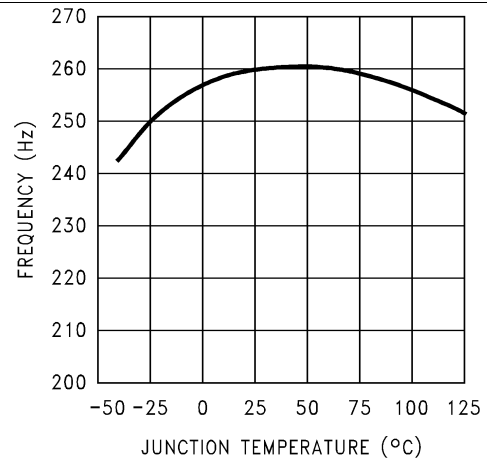

Figure 10. Switching Frequency

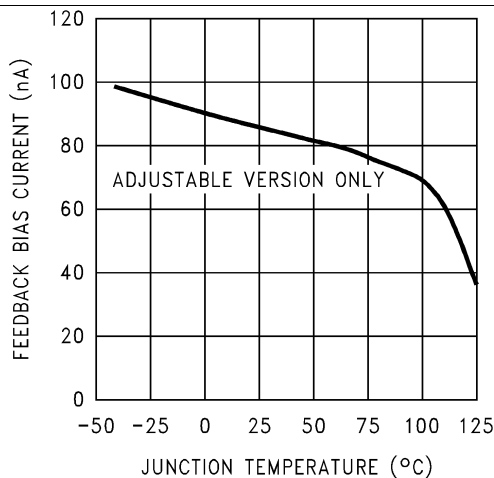
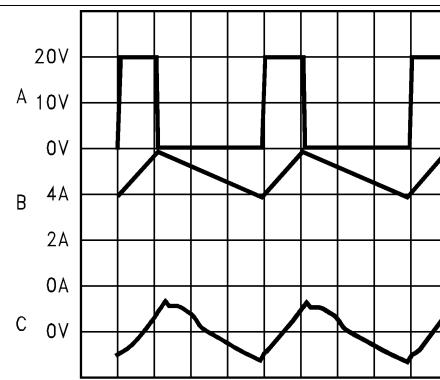

Figure 11. Feedback Pin Bias Current



Continuous Mode Switching Waveforms, $V_{IN} = 20V$, $V_{OUT} = 5V$,
 $I_{LOAD} = 5A$, $L = 10\mu H$, $C_{OUT} = 400\mu F$, $C_{OUTESR} = 13m\Omega$
 A. V_{SW} pin voltage = 10 V/div
 B. Inductor current = 2 A/div
 C. Output ripple voltage = 20 mV/div AC-coupled

Figure 12. Horizontal Time Base: 1 µs/div

Typical Characteristics (continued)

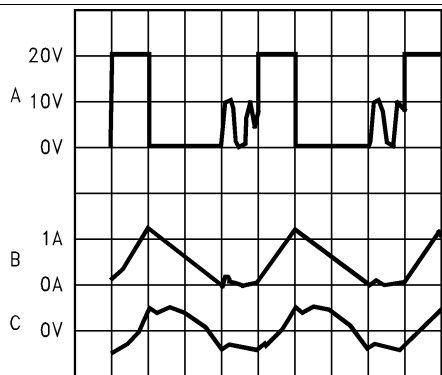

1 μ sec/Div

Discontinuous Mode Switching Waveforms, $V_{IN} = 20$ V, $V_{OUT} = 5$ V, $I_{LOAD} = 500$ mA, $L = 10$ μ H, $C_{OUT} = 400$ μ F, $C_{OUT}ESR = 13$ m Ω

A. V_{SW} pin voltage = 10 V/div

B. Inductor current = 1 A/div

C. Output ripple voltage = 20 mV/div AC-coupled

Figure 13. Horizontal Time Base: 1 μ s/div

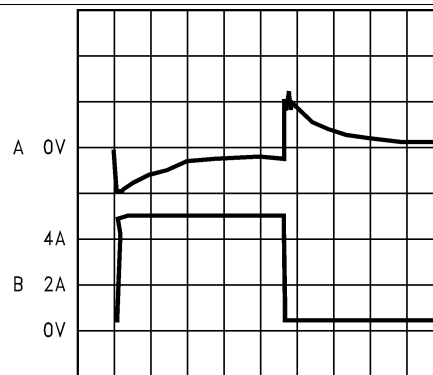

100 μ sec/Div

Load Transient Response for Continuous Mode, $V_{IN} = 20$ V, $V_{OUT} = 5$ V, $L = 10$ μ H, $C_{OUT} = 400$ μ F, $C_{OUT}ESR = 13$ m Ω

A. Output voltage = 100 mV/div, AC-coupled

B. Load current = 500-mA to 5-A load pulse

Figure 14. Horizontal Time Base: 100 μ s/div

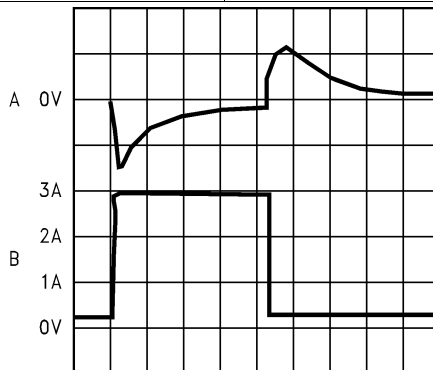

200 μ sec/Div

Load Transient Response for Discontinuous Mode, $V_{IN} = 20$ V, $V_{OUT} = 5$ V, vs $L = 10$ μ H, $C_{OUT} = 400$ μ F, $C_{OUT}ESR = 13$ m Ω

A. Output voltage = 100 mV/div, AC-coupled

B. Load current = 200-mA to 3-A load pulse

Figure 15. Horizontal Time Base: 200 μ s/div

Feature Description (continued)

7.3.2 Input

The input voltage for the power supply is connected to pin 2. In addition to providing energy to the load the input voltage also provides bias for the internal circuitry of the LM2678. For ensured performance the input voltage must be in the range of 8 V to 40 V. For best performance of the power supply the input pin must always be bypassed with an input capacitor located close to pin 2.

7.3.3 C Boost

A capacitor must be connected from pin 3 to the switch output, pin 1. This capacitor boosts the gate drive to the internal MOSFET above V_{IN} to fully turn it ON. This minimizes conduction losses in the power switch to maintain high efficiency. The recommended value for C Boost is 0.01 μ F.

7.3.4 Ground

This is the ground reference connection for all components in the power supply. In fast-switching, high-current applications such as those implemented with the LM2678, TI recommends that a broad ground plane be used to minimize signal coupling throughout the circuit.

7.3.5 Feedback

This is the input to a two-stage high gain amplifier, which drives the PWM controller. It is necessary to connect pin 6 to the actual output of the power supply to set the DC output voltage. For the fixed output devices (3.3-V, 5-V and 12-V outputs), a direct wire connection to the output is all that is required as internal gain setting resistors are provided inside the LM2678. For the adjustable output version two external resistors are required to set the DC output voltage. For stable operation of the power supply it is important to prevent coupling of any inductor flux to the feedback input.

7.3.6 ON/OFF

This input provides an electrical ON/OFF control of the power supply. Connecting this pin to ground or to any voltage less than 0.8 V is completely turn OFF the regulator. The current drain from the input supply when OFF is only 50 μ A. Pin 7 has an internal pullup current source of approximately 20 μ A and a protection clamp Zener diode of 7 V to ground. When electrically driving the ON/OFF pin the high voltage level for the ON condition should not exceed the 6 V absolute maximum limit. When ON/OFF control is not required pin 7 should be left open circuited.

7.4 Device Functional Modes

7.4.1 Shutdown Mode

The ON/OFF pin provides electrical ON and OFF control for the LM2678. When the voltage of this pin is lower than 1.4 V, the device enters shutdown mode. The typical standby current in this mode is 45 μ A.

7.4.2 Active Mode

When the voltage of the ON/OFF pin is higher than 1.4 V, the device starts switching and the output voltage rises until it reaches a normal regulation voltage.

8 Application and Implementation

NOTE

Information in the following applications sections is not part of the TI component specification, and TI does not warrant its accuracy or completeness. TI's customers are responsible for determining suitability of components for their purposes. Customers should validate and test their design implementation to confirm system functionality.

8.1 Application Information

8.1.1 Design Considerations

Power supply design using the LM2678 is greatly simplified by using recommended external components. A wide range of inductors, capacitors, and Schottky diodes from several manufacturers have been evaluated for use in designs that cover the full range of capabilities (input voltage, output voltage, and load current) of the LM2678. A simple design procedure using nomographs and component tables provided in this data sheet leads to a working design with very little effort.

The individual components from the various manufacturers called out for use are still just a small sample of the vast array of components available in the industry. While these components are recommended, they are not exclusively the only components for use in a design. After a close comparison of component specifications, equivalent devices from other manufacturers could be substituted for use in an application.

Important considerations for each external component and an explanation of how the nomographs and selection tables were developed follows.

8.1.2 Inductor

The inductor is the key component in a switching regulator. For efficiency the inductor stores energy during the switch ON time and then transfers energy to the load while the switch is OFF.

Nomographs are used to select the inductance value required for a given set of operating conditions. The nomographs assume that the circuit is operating in continuous mode (the current flowing through the inductor never falls to zero). The magnitude of inductance is selected to maintain a maximum ripple current of 30% of the maximum load current. If the ripple current exceeds this 30% limit the next larger value is selected.

The inductors offered have been specifically manufactured to provide proper operation under all operating conditions of input and output voltage and load current. Several part types are offered for a given amount of inductance. Both surface mount and through-hole devices are available. The inductors from each of the three manufacturers have unique characteristics.

- Renco: ferrite stick core inductors; benefits are typically lowest cost and can withstand ripple and transient peak currents above the rated value. These inductors have an external magnetic field, which may generate EMI.
- Pulse Engineering: powdered iron toroid core inductors; these also can withstand higher than rated currents and, being toroid inductors, have low EMI.
- Coilcraft: ferrite drum core inductors; these are the smallest physical size inductors and are available only as surface mount components. These inductors also generate EMI but less than stick inductors.

8.1.3 Output Capacitor

The output capacitor acts to smooth the DC output voltage and also provides energy storage. Selection of an output capacitor, with an associated equivalent series resistance (ESR), impacts both the amount of output ripple voltage and stability of the control loop.

The output ripple voltage of the power supply is the product of the capacitor ESR and the inductor ripple current. The capacitor types recommended in the tables were selected for having low ESR ratings.

In addition, both surface mount tantalum capacitors and through-hole aluminum electrolytic capacitors are offered as solutions.

Application Information (continued)

Impacting frequency stability of the overall control loop, the output capacitance, in conjunction with the inductor, creates a double pole inside the feedback loop. In addition the capacitance and the ESR value create a zero. These frequency response effects together with the internal frequency compensation circuitry of the LM2678 modify the gain and phase shift of the closed-loop system.

As a general rule for stable switching regulator circuits it is desired to have the unity gain bandwidth of the circuit to be limited to no more than one-sixth of the controller switching frequency. With the fixed 260-kHz switching frequency of the LM2678, the output capacitor is selected to provide a unity gain bandwidth of 40 kHz maximum. Each recommended capacitor value has been chosen to achieve this result.

In some cases multiple capacitors are required either to reduce the ESR of the output capacitor, to minimize output ripple (a ripple voltage of 1% of V_{OUT} or less is the assumed performance condition), or to increase the output capacitance to reduce the closed loop unity gain bandwidth (to less than 40 kHz). When parallel combinations of capacitors are required it has been assumed that each capacitor is the exact same part type.

The RMS current and working voltage (WV) ratings of the output capacitor are also important considerations. In a typical step-down switching regulator, the inductor ripple current (set to be no more than 30% of the maximum load current by the inductor selection) is the current that flows through the output capacitor. The capacitor RMS current rating must be greater than this ripple current. The voltage rating of the output capacitor should be greater than 1.3 times the maximum output voltage of the power supply. If operation of the system at elevated temperatures is required, the capacitor voltage rating may be de-rated to less than the nominal room temperature rating. Careful inspection of the manufacturer's specification for de-rating of working voltage with temperature is important.

8.1.4 Input Capacitor

Fast changing currents in high current switching regulators place a significant dynamic load on the unregulated power source. An input capacitor helps to provide additional current to the power supply as well as smooth out input voltage variations.

Like the output capacitor, the key specifications for the input capacitor are RMS current rating and working voltage. The RMS current flowing through the input capacitor is equal to one-half of the maximum DC load current so the capacitor should be rated to handle this. Paralleling multiple capacitors proportionally increases the current rating of the total capacitance. The voltage rating should also be selected to be 1.3 times the maximum input voltage. Depending on the unregulated input power source, under light load conditions the maximum input voltage could be significantly higher than normal operation and should be considered when selecting an input capacitor.

The input capacitor must be placed very close to the input pin of the LM2678. Due to relative high current operation with fast transient changes, the series inductance of input connecting wires or PCB traces can create ringing signals at the input terminal which could possibly propagate to the output or other parts of the circuitry. It may be necessary in some designs to add a small valued (0.1 μF to 0.47 μF) ceramic type capacitor in parallel with the input capacitor to prevent or minimize any ringing.

8.1.5 Catch Diode

When the power switch in the LM2678 turns OFF, the current through the inductor continues to flow. The path for this current is through the diode connected between the switch output and ground. This forward biased diode clamps the switch output to a voltage less than ground. This negative voltage must be greater than -1 V so a low voltage drop (particularly at high current levels) Schottky diode is recommended. Total efficiency of the entire power supply is significantly impacted by the power lost in the output catch diode. The average current through the catch diode is dependent on the switch duty cycle (D) and is equal to the load current times (1-D). Use of a diode rated for much higher current than is required by the actual application helps to minimize the voltage drop and power loss in the diode.

During the switch ON time the diode will be reversed biased by the input voltage. The reverse voltage rating of the diode must be at least 1.3 times greater than the maximum input voltage.

Application Information (continued)

8.1.6 Boost Capacitor

The boost capacitor creates a voltage used to overdrive the gate of the internal power MOSFET. This improves efficiency by minimizing the ON-resistance of the switch and associated power loss. For all applications it is recommended to use a 0.01- μF , 50-V ceramic capacitor.

8.1.7 Additional Application Information

When the output voltage is greater than approximately 6 V, and the duty cycle at minimum input voltage is greater than approximately 50%, the designer should exercise caution in selection of the output filter components. When an application designed to these specific operating conditions is subjected to a current limit fault condition, it may be possible to observe a large hysteresis in the current limit. This can affect the output voltage of the device until the load current is reduced sufficiently to allow the current limit protection circuit to reset itself.

Under current limiting conditions, the LM267x is designed to respond in the following manner:

1. At the moment when the inductor current reaches the current limit threshold, the ON-pulse is immediately terminated. This happens for any application condition.
2. However, the current limit block is also designed to momentarily reduce the duty cycle to below 50% to avoid subharmonic oscillations, which could cause the inductor to saturate.
3. Thereafter, once the inductor current falls below the current limit threshold, there is a small relaxation time during which the duty cycle progressively rises back above 50% to the value required to achieve regulation.

If the output capacitance is sufficiently *large*, it may be possible that as the output tries to recover, the output capacitor charging current is large enough to repeatedly re-trigger the current limit circuit before the output has fully settled. This condition is exacerbated with higher output voltage settings because the energy requirement of the output capacitor varies as the square of the output voltage ($\frac{1}{2} CV^2$), thus requiring an increased charging current.

A simple test to determine if this condition might exist for a suspect application is to apply a short circuit across the output of the converter, and then remove the shorted output condition. In an application with properly selected external components, the output will recover smoothly.

Practical values of external components that have been experimentally found to work well under these specific operating conditions are $C_{\text{OUT}} = 47 \mu\text{F}$, $L = 22 \mu\text{H}$. It should be noted that even with these components, for a device's current limit of I_{CLIM} , the maximum load current under which the possibility of the large current limit hysteresis can be minimized is $I_{\text{CLIM}}/2$. For example, if the input is 24 V and the set output voltage is 18 V, then for a desired maximum current of 1.5 A, the current limit of the chosen switcher must be confirmed to be at least 3 A.

Under extreme overcurrent or short circuit conditions, the LM267X employs frequency foldback in addition to the current limit. If the cycle-by-cycle inductor current increases above the current limit threshold (due to short circuit or inductor saturation for example) the switching frequency is automatically reduced to protect the IC. Frequency below 100 kHz is typical for an extreme short-circuit condition.

8.2 Typical Application

8.2.1 All Output Voltage Versions

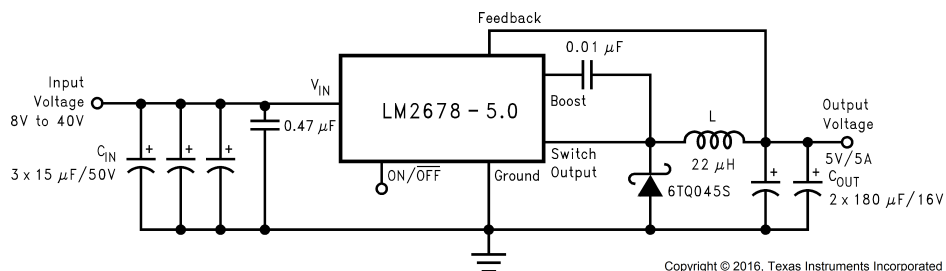

Figure 16. Typical Application for All Output Voltage Versions

Typical Application (continued)

8.2.1.1 Design Requirements

Select the power supply operating conditions and the maximum output current and follow below procedures to find the external components for LM2678.

8.2.1.2 Detailed Design Procedure

8.2.1.2.1 Custom Design With WEBENCH® Tools

[Click here](#) to create a custom design using the LM2678 device with the WEBENCH® Power Designer.

1. Start by entering the input voltage (V_{IN}), output voltage (V_{OUT}), and output current (I_{OUT}) requirements.
2. Optimize the design for key parameters such as efficiency, footprint, and cost using the optimizer dial.
3. Compare the generated design with other possible solutions from Texas Instruments.

The WEBENCH Power Designer provides a customized schematic along with a list of materials with real-time pricing and component availability.

In most cases, these actions are available:

- Run electrical simulations to see important waveforms and circuit performance
- Run thermal simulations to understand board thermal performance
- Export customized schematic and layout into popular CAD formats
- Print PDF reports for the design, and share the design with colleagues

Get more information about WEBENCH tools at www.ti.com/WEBENCH.

Using the nomographs and tables in this data sheet (or use the available design software at www.ti.com) a complete step-down regulator can be designed in a few simple steps.

Step 1: Define the power supply operating conditions:

- Required output voltage
- Maximum DC input voltage
- Maximum output load current

Step 2: Set the output voltage by selecting a fixed output LM2678 (3.3-V, 5-V, or 12-V applications) or determine the required feedback resistors for use with the adjustable LM2678-ADJ

Step 3: Determine the inductor required by using one of the four nomographs, [Figure 17](#) through [Figure 20](#). [Table 3](#) provides a specific manufacturer and part number for the inductor.

Step 4: Using [Table 5](#) (fixed output voltage) or [Table 9](#) (adjustable output voltage), determine the output capacitance required for stable operation. [Table 1](#) provides the specific capacitor type from the manufacturer of choice.

Step 5: Determine an input capacitor from [Table 5](#) for fixed output voltage applications. Use [Table 1](#) to find the specific capacitor type. For adjustable output circuits select a capacitor from [Table 1](#) with a sufficient working voltage (WV) rating greater than V_{IN} max, and an RMS current rating greater than one-half the maximum load current (2 or more capacitors in parallel may be required).

Step 6: Select a diode from [Table 4](#). The current rating of the diode must be greater than I_{LOAD} max and the reverse voltage rating must be greater than V_{IN} maximum.

Step 7: Include a 0.01- μ F, 50-V capacitor for C_{BOOST} in the design.

8.2.1.2.2 Capacitor Selection Guides

Table 1. Input and Output Capacitor Codes – Surface Mount

| CAPACITOR REFERENCE CODE | SURFACE MOUNT | | | | | | | | |
|--------------------------------|----------------|--------|----------------------|---------------------|--------|----------------------|-------------------|--------|----------------------|
| | AVX TPS SERIES | | | SPRAGUE 594D SERIES | | | KEMET T495 SERIES | | |
| | C (μ F) | WV (V) | I _{rms} (A) | C (μ F) | WV (V) | I _{rms} (A) | C (μ F) | WV (V) | I _{rms} (A) |
| C1 | 330 | 6.3 | 1.15 | 120 | 6.3 | 1.1 | 100 | 6.3 | 0.82 |
| C2 | 100 | 10 | 1.1 | 220 | 6.3 | 1.4 | 220 | 6.3 | 1.1 |

Typical Application (continued)
Table 1. Input and Output Capacitor Codes – Surface Mount (continued)

| CAPACITOR REFERENCE CODE | SURFACE MOUNT | | | | | | | | |
|--------------------------------|----------------|--------|----------------------|---------------------|--------|----------------------|-------------------|--------|----------------------|
| | AVX TPS SERIES | | | SPRAGUE 594D SERIES | | | KEMET T495 SERIES | | |
| | C (μF) | WV (V) | I _{rms} (A) | C (μF) | WV (V) | I _{rms} (A) | C (μF) | WV (V) | I _{rms} (A) |
| C3 | 220 | 10 | 1.15 | 68 | 10 | 1.05 | 330 | 6.3 | 1.1 |
| C4 | 47 | 16 | 0.89 | 150 | 10 | 1.35 | 100 | 10 | 1.1 |
| C5 | 100 | 16 | 1.15 | 47 | 16 | 1 | 150 | 10 | 1.1 |
| C6 | 33 | 20 | 0.77 | 100 | 16 | 1.3 | 220 | 10 | 1.1 |
| C7 | 68 | 20 | 0.94 | 180 | 16 | 1.95 | 33 | 20 | 0.78 |
| C8 | 22 | 25 | 0.77 | 47 | 20 | 1.15 | 47 | 20 | 0.94 |
| C9 | 10 | 35 | 0.63 | 33 | 25 | 1.05 | 68 | 20 | 0.94 |
| C10 | 22 | 35 | 0.66 | 68 | 25 | 1.6 | 10 | 35 | 0.63 |
| C11 | — | — | — | 15 | 35 | 0.75 | 22 | 35 | 0.63 |
| C12 | — | — | — | 33 | 35 | 1 | 4.7 | 50 | 0.66 |
| C13 | — | — | — | 15 | 50 | 0.9 | — | — | — |

Table 2. Input and Output Capacitor Codes – Through Hole

| CAPACITOR REFERENCE CODE | THROUGH HOLE | | | | | | | | | | | |
|--------------------------------|------------------------|--------|----------------------|--------------------|--------|----------------------|--------------------|--------|----------------------|----------------------|--------|----------------------|
| | SANYO OS-CON SA SERIES | | | SANYO MV-GX SERIES | | | NICHICON PL SERIES | | | PANASONIC HFQ SERIES | | |
| | C (μF) | WV (V) | I _{rms} (A) | C (μF) | WV (V) | I _{rms} (A) | C (μF) | WV (V) | I _{rms} (A) | C (μF) | WV (V) | I _{rms} (A) |
| C1 | 47 | 6.3 | 1 | 1000 | 6.3 | 0.8 | 680 | 10 | 0.8 | 82 | 35 | 0.4 |
| C2 | 150 | 6.3 | 1.95 | 270 | 16 | 0.6 | 820 | 10 | 0.98 | 120 | 35 | 0.44 |
| C3 | 330 | 6.3 | 2.45 | 470 | 16 | 0.75 | 1000 | 10 | 1.06 | 220 | 35 | 0.76 |
| C4 | 100 | 10 | 1.87 | 560 | 16 | 0.95 | 1200 | 10 | 1.28 | 330 | 35 | 1.01 |
| C5 | 220 | 10 | 2.36 | 820 | 16 | 1.25 | 2200 | 10 | 1.71 | 560 | 35 | 1.4 |
| C6 | 33 | 16 | 0.96 | 1000 | 16 | 1.3 | 3300 | 10 | 2.18 | 820 | 35 | 1.62 |
| C7 | 100 | 16 | 1.92 | 150 | 35 | 0.65 | 3900 | 10 | 2.36 | 1000 | 35 | 1.73 |
| C8 | 150 | 16 | 2.28 | 470 | 35 | 1.3 | 6800 | 10 | 2.68 | 2200 | 35 | 2.8 |
| C9 | 100 | 20 | 2.25 | 680 | 35 | 1.4 | 180 | 16 | 0.41 | 56 | 50 | 0.36 |
| C10 | 47 | 25 | 2.09 | 1000 | 35 | 1.7 | 270 | 16 | 0.55 | 100 | 50 | 0.5 |
| C11 | — | — | — | 220 | 63 | 0.76 | 470 | 16 | 0.77 | 220 | 50 | 0.92 |
| C12 | — | — | — | 470 | 63 | 1.2 | 680 | 16 | 1.02 | 470 | 50 | 1.44 |
| C13 | — | — | — | 680 | 63 | 1.5 | 820 | 16 | 1.22 | 560 | 50 | 1.68 |
| C14 | — | — | — | 1000 | 63 | 1.75 | 1800 | 16 | 1.88 | 1200 | 50 | 2.22 |
| C15 | — | — | — | — | — | — | 220 | 25 | 0.63 | 330 | 63 | 1.42 |
| C16 | — | — | — | — | — | — | 220 | 35 | 0.79 | 1500 | 63 | 2.51 |
| C17 | — | — | — | — | — | — | 560 | 35 | 1.43 | — | — | — |
| C18 | — | — | — | — | — | — | 2200 | 35 | 2.68 | — | — | — |
| C19 | — | — | — | — | — | — | 150 | 50 | 0.82 | — | — | — |
| C20 | — | — | — | — | — | — | 220 | 50 | 1.04 | — | — | — |
| C21 | — | — | — | — | — | — | 330 | 50 | 1.3 | — | — | — |
| C22 | — | — | — | — | — | — | 100 | 63 | 0.75 | — | — | — |
| C23 | — | — | — | — | — | — | 390 | 63 | 1.62 | — | — | — |
| C24 | — | — | — | — | — | — | 820 | 63 | 2.22 | — | — | — |
| C25 | — | — | — | — | — | — | 1200 | 63 | 2.51 | — | — | — |

Table 3. Inductor Manufacturer Part Numbers

| INDUCTOR REFERENCE NUMBER | INDUCTANCE (μH) | CURRENT (A) | RENCO | | PULSE ENGINEERING | | COILCRAFT |
|---------------------------------|--------------------|----------------|---------------|------------------|-------------------|------------------|---------------|
| | | | THROUGH HOLE | SURFACE MOUNT | THROUGH HOLE | SURFACE MOUNT | SURFACE MOUNT |
| L23 | 33 | 1.35 | RL-5471-7 | RL1500-33 | PE-53823 | PE-53823S | DO3316-333 |
| L24 | 22 | 1.65 | RL-1283-22-43 | RL1500-22 | PE-53824 | PE-53824S | DO3316-223 |
| L25 | 15 | 2 | RL-1283-15-43 | RL1500-15 | PE-53825 | PE-53825S | DO3316-153 |
| L29 | 100 | 1.41 | RL-5471-4 | RL-6050-100 | PE-53829 | PE-53829S | DO5022P-104 |
| L30 | 68 | 1.71 | RL-5471-5 | RL6050-68 | PE-53830 | PE-53830S | DO5022P-683 |
| L31 | 47 | 2.06 | RL-5471-6 | RL6050-47 | PE-53831 | PE-53831S | DO5022P-473 |
| L32 | 33 | 2.46 | RL-5471-7 | RL6050-33 | PE-53932 | PE-53932S | DO5022P-333 |
| L33 | 22 | 3.02 | RL-1283-22-43 | RL6050-22 | PE-53933 | PE-53933S | DO5022P-223 |
| L34 | 15 | 3.65 | RL-1283-15-43 | — | PE-53934 | PE-53934S | DO5022P-153 |
| L38 | 68 | 2.97 | RL-5472-2 | — | PE-54038 | PE-54038S | — |
| L39 | 47 | 3.57 | RL-5472-3 | — | PE-54039 | PE-54039S | — |
| L40 | 33 | 4.26 | RL-1283-33-43 | — | PE-54040 | PE-54040S | — |
| L41 | 22 | 5.22 | RL-1283-22-43 | — | PE-54041 | P0841 | — |
| L44 | 68 | 3.45 | RL-5473-3 | — | PE-54044 | — | — |
| L45 | 10 | 4.47 | RL-1283-10-43 | — | — | P0845 | DO5022P-103HC |
| L46 | 15 | 5.6 | RL-1283-15-43 | — | — | P0846 | DO5022P-153HC |
| L47 | 10 | 5.66 | RL-1283-10-43 | — | — | P0847 | DO5022P-103HC |
| L48 | 47 | 5.61 | RL-1282-47-43 | — | — | P0848 | — |
| L49 | 33 | 5.61 | RL-1282-33-43 | — | — | P0849 | — |

Table 4. Schottky Diode Selection Table

| REVERSE VOLTAGE (V) | SURFACE MOUNT | | THROUGH HOLE | |
|---------------------|---------------|-------------|--------------|-------------|
| | 3 A | 5 A OR MORE | 3 A | 5 A OR MORE |
| 20 | SK32 | — | 1N5820 | — |
| | | | SR302 | |
| 30 | SK33 | MBRD835L | 1N5821 | — |
| | 30WQ03F | | 31DQ03 | |
| 40 | SK34 | MBRD1545CT | 1N5822 | 1N5825 |
| | 30BQ040 | 6TQ045S | MBR340 | MBR745 |
| | 30WQ04F | — | 31DQ04 | 80SQ045 |
| | MBRS340 | — | SR403 | 6TQ045 |
| | MBRD340 | — | — | — |
| 50 or more | SK35 | — | MBR350 | — |
| | 30WQ05F | — | 31DQ05 | — |
| | — | — | SR305 | — |

8.2.1.3 Application Curves

For continuous mode operation

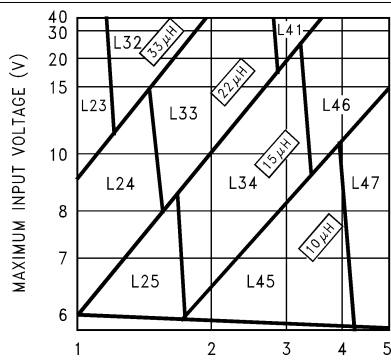

Figure 17. LM2678-3-3

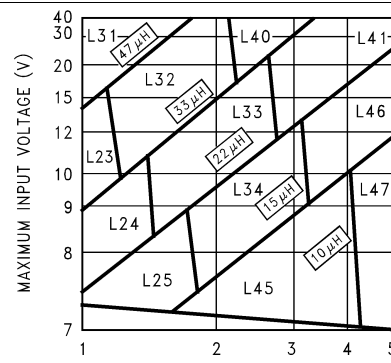

Figure 18. LM2678-5

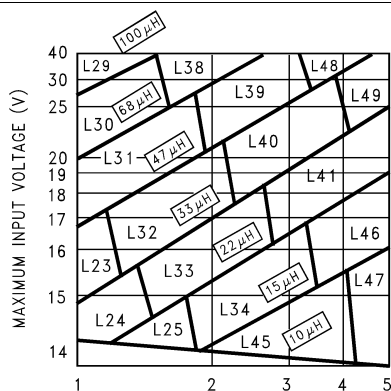

Figure 19. LM2678-12

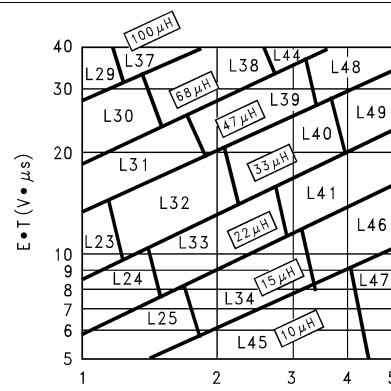

Figure 20. LM2678-Adjustable

8.2.2 Fixed Output Voltage Design Example

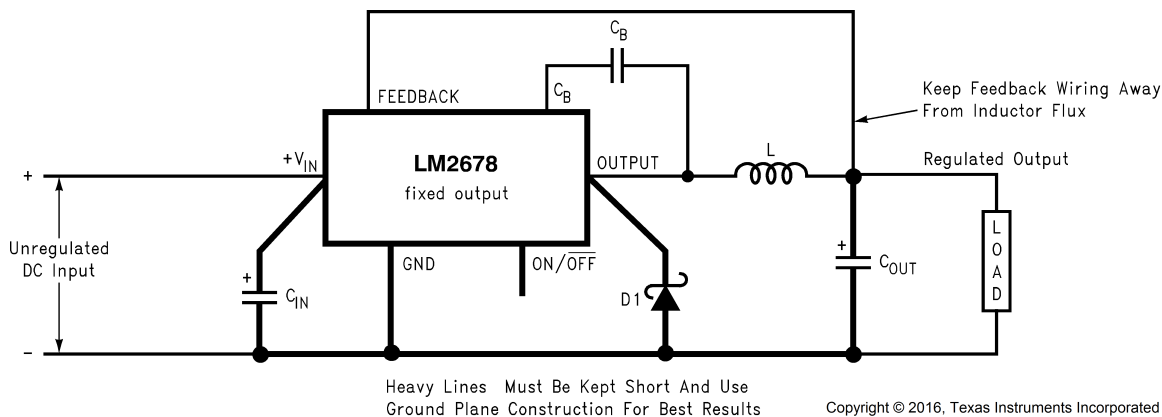

Figure 21. Basic Circuit for Fixed Output Voltage Applications

8.2.2.1 Detailed Design Procedure

A system logic power supply bus of 3.3 V is to be generated from a wall adapter which provides an unregulated DC voltage of 13 V to 16 V. The maximum load current is 4 A. Through-hole components are preferred.

Step 1: Operating conditions are:

- $V_{OUT} = 3.3\text{ V}$
- $V_{IN\text{ max}} = 16\text{ V}$
- $I_{LOAD\text{ max}} = 4\text{ A}$

Step 2: Select a LM2678 3.3-V. The output voltage has a tolerance of $\pm 2\%$ at room temperature and $\pm 3\%$ over the full operating temperature range.

Step 3: Use the nomograph for the 3.3-V device, [Figure 17](#). The intersection of the 16-V horizontal line ($V_{in\text{ max}}$) and the 4-A vertical line ($I_{load\text{ max}}$) indicates that L46, a 15- μH inductor, is required.

From [Table 3](#), L46 in a through-hole component is available from Renco with part number RL-1283-15-43.

Step 4: Use [Table 5](#) to determine an output capacitor. With a 3.3-V output and a 15- μH inductor there are four through-hole output capacitor solutions with the number of same type capacitors to be paralleled and an identifying capacitor code given. [Table 1](#) provides the actual capacitor characteristics. Any of the following choices work in the circuit:

- 2 \times 220- μF , 10-V Sanyo OS-CON (code C5)
- 2 \times 820- μF , 16-V Sanyo MV-GX (code C5)
- 1 \times 3900- μF , 10-V Nichicon PL (code C7)
- 2 \times 560- μF , 35-V Panasonic HFQ (code C5)

Step 5: Use [Table 5](#) to select an input capacitor. With 3.3-V output and 15 μH there are three through-hole solutions. These capacitors provide a sufficient voltage rating and an RMS current rating greater than 2 A ($1/2 I_{load\text{ max}}$). Again using [Table 1](#) for specific component characteristics the following choices are suitable:

- 2 \times 680- μF , 63-V Sanyo MV-GX (code C13)
- 1 \times 1200- μF , 63-V Nichicon PL (code C25)
- 1 \times 1500- μF , 63-V Panasonic HFQ (code C16)

Step 6: From [Table 4](#) a 5-A or more Schottky diode must be selected. For through-hole components only 40-V rated diodes are indicated and 4 part types are suitable:

- 1N5825
- MBR745
- 80SQ045
- 6TQ045

Step 7: A 0.01- μF capacitor is used for C_{BOOST} .

8.2.2.1.1 Capacitor Selection
Table 5. Output Capacitors for Fixed Output Voltage Application—Surface Mount⁽¹⁾⁽²⁾

| OUTPUT VOLTAGE (V) | INDUCTANCE (μH) | SURFACE MOUNT | | | | | |
|--------------------|-----------------|----------------|--------|---------------------|--------|-------------------|--------|
| | | AVX TPS SERIES | | SPRAGUE 594D SERIES | | KEMET T495 SERIES | |
| | | NO. | C CODE | NO. | C CODE | NO. | C CODE |
| 3.3 | 10 | 5 | C1 | 5 | C1 | 5 | C2 |
| | 15 | 4 | C1 | 4 | C1 | 4 | C3 |
| | 22 | 3 | C2 | 2 | C7 | 3 | C4 |
| | 33 | 1 | C1 | 2 | C7 | 3 | C4 |
| 5 | 10 | 4 | C2 | 4 | C6 | 4 | C4 |
| | 15 | 3 | C3 | 2 | C7 | 3 | C5 |
| | 22 | 3 | C2 | 2 | C7 | 3 | C4 |
| | 33 | 2 | C2 | 2 | C3 | 2 | C4 |
| | 47 | 2 | C2 | 1 | C7 | 2 | C4 |
| 12 | 10 | 4 | C5 | 3 | C6 | 5 | C9 |
| | 15 | 3 | C5 | 2 | C7 | 4 | C9 |
| | 22 | 2 | C5 | 2 | C6 | 3 | C8 |
| | 33 | 2 | C5 | 1 | C7 | 3 | C8 |
| | 47 | 2 | C4 | 1 | C6 | 2 | C8 |
| | 68 | 1 | C5 | 1 | C5 | 2 | C7 |
| 100 | 1 | C4 | 1 | C5 | 1 | C8 | |

(1) No. represents the number of identical capacitor types to be connected in parallel.

(2) C Code indicates the Capacitor Reference number in [Table 1](#) and [Table 2](#) for identifying the specific component from the manufacturer.

Table 6. Output Capacitors for Fixed Output Voltage Application—Through Hole⁽¹⁾⁽²⁾

| OUTPUT VOLTAGE (V) | INDUCTANCE (μH) | THROUGH HOLE | | | | | | | |
|--------------------|-----------------|------------------------|--------|--------------------|--------|--------------------|--------|----------------------|--------|
| | | SANYO OS-CON SA SERIES | | SANYO MV-GX SERIES | | NICHICON PL SERIES | | PANASONIC HFQ SERIES | |
| | | NO. | C CODE | NO. | C CODE | NO. | C CODE | NO. | C CODE |
| 3.3 | 10 | 2 | C5 | 2 | C6 | 1 | C8 | 2 | C6 |
| | 15 | 2 | C5 | 2 | C5 | 1 | C7 | 2 | C5 |
| | 22 | 1 | C5 | 1 | C10 | 1 | C5 | 1 | C7 |
| | 33 | 1 | C5 | 1 | C10 | 1 | C5 | 1 | C7 |
| 5 | 10 | 2 | C4 | 2 | C5 | 1 | C6 | 2 | C5 |
| | 15 | 1 | C5 | 1 | C10 | 1 | C5 | 1 | C7 |
| | 22 | 1 | C5 | 1 | C9 | 1 | C5 | 1 | C5 |
| | 33 | 1 | C4 | 1 | C5 | 1 | C4 | 1 | C4 |
| | 47 | 1 | C4 | 1 | C4 | 1 | C2 | 2 | C4 |
| 12 | 10 | 2 | C7 | 1 | C10 | 1 | C14 | 2 | C4 |
| | 15 | 1 | C8 | 1 | C6 | 1 | C17 | 1 | C5 |
| | 22 | 1 | C7 | 1 | C5 | 1 | C13 | 1 | C5 |
| | 33 | 1 | C7 | 1 | C4 | 1 | C12 | 1 | C4 |
| | 47 | 1 | C7 | 1 | C3 | 1 | C11 | 1 | C3 |
| | 68 | 1 | C6 | 1 | C2 | 1 | C10 | 1 | C3 |
| 100 | 1 | C6 | 1 | C2 | 1 | C9 | 1 | C1 | |

(1) No. represents the number of identical capacitor types to be connected in parallel.

(2) C Code indicates the Capacitor Reference number in [Table 1](#) and [Table 2](#) for identifying the specific component from the manufacturer.

Table 7. Input Capacitors for Fixed Output Voltage Application—Surface Mount^{(1)(2) (3)}

| OUTPUT VOLTAGE (V) | INDUCTANCE (μH) | SURFACE MOUNT | | | | | |
|--------------------|-----------------|--------------------|--------------------|---------------------|--------|-------------------|--------|
| | | AVX TPS SERIES | | SPRAGUE 594D SERIES | | KEMET T495 SERIES | |
| | | NO. | C CODE | NO. | C CODE | NO. | C CODE |
| 3.3 | 10 | 3 | C7 | 2 | C10 | 3 | C9 |
| | 15 | See ⁽⁴⁾ | See ⁽⁴⁾ | 3 | C13 | 4 | C12 |
| | 22 | See ⁽⁴⁾ | See ⁽⁴⁾ | 2 | C13 | 3 | C12 |
| | 33 | See ⁽⁴⁾ | See ⁽⁴⁾ | 2 | C13 | 3 | C12 |
| 5 | 10 | 3 | C4 | 2 | C6 | 3 | C9 |
| | 15 | 4 | C9 | 3 | C12 | 4 | C10 |
| | 22 | See ⁽⁴⁾ | See ⁽⁴⁾ | 3 | C13 | 4 | C12 |
| | 33 | See ⁽⁴⁾ | See ⁽⁴⁾ | 2 | C13 | 3 | C12 |
| | 47 | See ⁽⁴⁾ | See ⁽⁴⁾ | 1 | C13 | 2 | C12 |
| 12 | 10 | 4 | C9 | 2 | C10 | 4 | C10 |
| | 15 | 4 | C8 | 2 | C10 | 4 | C10 |
| | 22 | 4 | C9 | 3 | C12 | 4 | C10 |
| | 33 | See ⁽⁴⁾ | See ⁽⁴⁾ | 3 | C13 | 4 | C12 |
| | 47 | See ⁽⁴⁾ | See ⁽⁴⁾ | 2 | C13 | 3 | C12 |
| | 68 | See ⁽⁴⁾ | See ⁽⁴⁾ | 2 | C13 | 2 | C12 |
| | 100 | See ⁽⁴⁾ | See ⁽⁴⁾ | 1 | C13 | 2 | C12 |

- (1) No. represents the number of identical capacitor types to be connected in parallel.
- (2) C Code indicates the Capacitor Reference number in [Table 1](#) and [Table 2](#) for identifying the specific component from the manufacturer.
- (3) Assumes worst case maximum input voltage and load current for a given inductance value.
- (4) Check voltage rating of capacitors to be greater than application input voltage.

Table 8. Input Capacitors for Fixed Output Voltage Application—Through Hole^{(1)(2) (3)}

| OUTPUT VOLTAGE (V) | INDUCTANCE (μH) | THROUGH HOLE | | | | | | | |
|--------------------|-----------------|------------------------|--------------------|--------------------|--------|--------------------|--------|----------------------|--------|
| | | SANYO OS-CON SA SERIES | | SANYO MV-GX SERIES | | NICHICON PL SERIES | | PANASONIC HFQ SERIES | |
| | | NO. | C CODE | NO. | C CODE | NO. | C CODE | NO. | C CODE |
| 3.3 | 10 | 2 | C9 | 2 | C8 | 1 | C18 | 1 | C8 |
| | 15 | See ⁽⁴⁾ | See ⁽⁴⁾ | 2 | C13 | 1 | C25 | 1 | C16 |
| | 22 | See ⁽⁴⁾ | See ⁽⁴⁾ | 1 | C14 | 1 | C24 | 1 | C16 |
| | 33 | See ⁽⁴⁾ | See ⁽⁴⁾ | 1 | C14 | 1 | C24 | 1 | C16 |
| 5 | 10 | 2 | C7 | 2 | C8 | 1 | C25 | 1 | C8 |
| | 15 | See ⁽⁴⁾ | See ⁽⁴⁾ | 2 | C8 | 1 | C25 | 1 | C8 |
| | 22 | See ⁽⁴⁾ | See ⁽⁴⁾ | 2 | C13 | 1 | C25 | 1 | C16 |
| | 33 | See ⁽⁴⁾ | See ⁽⁴⁾ | 1 | C14 | 1 | C23 | 1 | C13 |
| | 47 | See ⁽⁴⁾ | See ⁽⁴⁾ | 1 | C12 | 1 | C19 | 1 | C11 |
| 12 | 10 | 2 | C10 | 2 | C8 | 1 | C18 | 1 | C8 |
| | 15 | 2 | C10 | 2 | C8 | 1 | C18 | 1 | C8 |
| | 22 | See ⁽⁴⁾ | See ⁽⁴⁾ | 2 | C8 | 1 | C18 | 1 | C8 |
| | 33 | See ⁽⁴⁾ | See ⁽⁴⁾ | 2 | C12 | 1 | C24 | 1 | C14 |
| | 47 | See ⁽⁴⁾ | See ⁽⁴⁾ | 1 | C14 | 1 | C23 | 1 | C13 |
| | 68 | See ⁽⁴⁾ | See ⁽⁴⁾ | 1 | C13 | 1 | C21 | 1 | C15 |
| | 100 | See ⁽⁴⁾ | See ⁽⁴⁾ | 1 | C11 | 1 | C22 | 1 | C11 |

- (1) No. represents the number of identical capacitor types to be connected in parallel.
- (2) C Code indicates the Capacitor Reference number in [Table 1](#) and [Table 2](#) for identifying the specific component from the manufacturer.
- (3) Assumes worst case maximum input voltage and load current for a given inductance value.
- (4) Check voltage rating of capacitors to be greater than application input voltage.

8.2.3 Adjustable Output Design Example

Locate the Programming Resistors near the Feedback Pin Using Short Leads

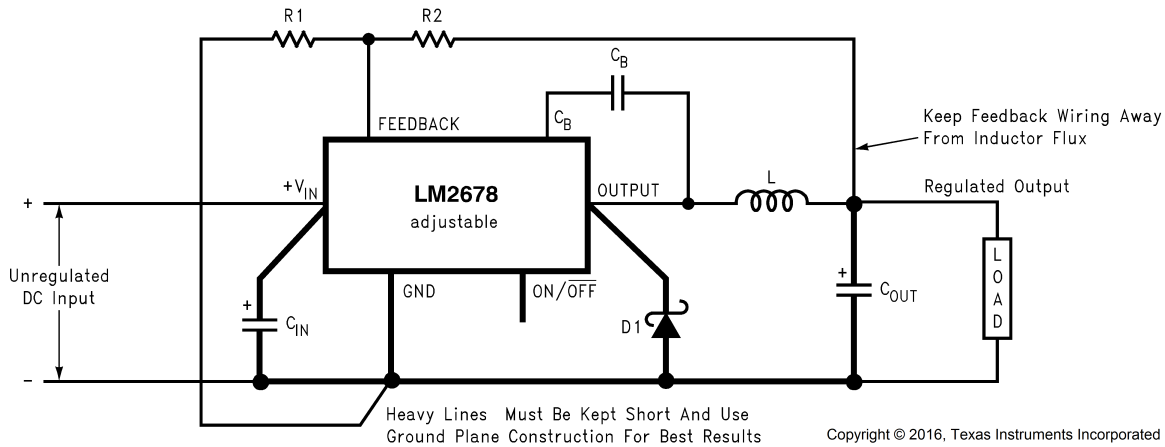

Figure 22. Basic Circuit for Adjustable Output Voltage Applications

8.2.3.1 Detailed Design Procedure

In this example it is desired to convert the voltage from a two battery automotive power supply (voltage range of 20 V to 28 V, typical in large truck applications) to the 14.8-VDC alternator supply typically used to power electronic equipment from single battery 12-V vehicle systems. The load current required is 3.5 A maximum. It is also desired to implement the power supply with all surface mount components.

Step 1: Operating conditions are:

- $V_{OUT} = 14.8\text{ V}$
- $V_{IN\text{ max}} = 28\text{ V}$
- $I_{LOAD\text{ max}} = 3.5\text{ A}$

Step 2: Select an LM2678S-ADJ. To set the output voltage to 14.9-V two resistors need to be chosen (R_1 and R_2 in Figure 22). For the adjustable device the output voltage is set by Equation 1.

$$V_{OUT} = V_{FB} \left(1 + \frac{R_2}{R_1} \right)$$

where

- V_{FB} is the feedback voltage of typically 1.21 V (1)

A recommended value to use for R_1 is 1k. In this example then R_2 is determined with Equation 2.

$$R_2 = R_1 \left(\frac{V_{OUT}}{V_{FB}} - 1 \right) = 1\text{ k}\Omega \left(\frac{14.8\text{ V}}{1.21\text{ V}} - 1 \right)$$

where

- $R_2 = 11.23\text{ k}\Omega$ (2)

The closest standard 1% tolerance value to use is 11.3 k Ω .

This sets the nominal output voltage to 14.88 V which is within 0.5% of the target value.

Step 3: To use the nomograph for the adjustable device, Figure 20, requires a calculation of the inductor Volt • microsecond constant ($E \cdot T$ expressed in $V \cdot \mu\text{s}$) from Equation 3.

$$E \cdot T = (V_{IN(MAX)} - V_{OUT} - V_{SAT}) \cdot \frac{V_{OUT} + V_D}{V_{IN(MAX)} - V_{SAT} + V_D} \cdot \frac{1000}{260} \text{ (V} \cdot \mu\text{s)}$$

where

- V_{SAT} is the voltage drop across the internal power switch which is $R_{ds(ON)}$ times I_{load} (3)

In this example this would be typically $0.12 \Omega \times 3.5 \text{ A}$ or 0.42 V and V_D is the voltage drop across the forward biased Schottky diode, typically 0.5 V . The switching frequency of 260 kHz is the nominal value to use to estimate the ON time of the switch during which energy is stored in the inductor.

For this example, $E \cdot T$ is found with [Equation 4](#) and [Equation 5](#).

$$E \cdot T = (28 - 14.8 - 0.42) \cdot \frac{14.8 + 0.5}{28 - 0.42 + 0.5} \cdot \frac{1000}{260} \text{ (V} \cdot \mu\text{s)} \quad (4)$$

$$E \cdot T = (12.78\text{V}) \cdot \frac{15.3\text{V}}{28.08\text{V}} \cdot 3.85 \text{ (V} \cdot \mu\text{s)} = 26.8 \text{ (V} \cdot \mu\text{s)} \quad (5)$$

Using [Figure 20](#), the intersection of $27 \text{ V} \cdot \mu\text{S}$ horizontally and the 3.5 A vertical line ($I_{\text{LOAD max}}$) indicates that L48, a $47\text{-}\mu\text{H}$ inductor, or L49, a $33\text{-}\mu\text{H}$ inductor could be used. Either inductor will be suitable, but for this example selecting the larger inductance results in lower ripple current.

From [Table 3](#), L48 in a surface mount component is available from Pulse Engineering with part number P0848.

Step 4: Use [Table 9](#) to determine an output capacitor. With a 14.8-V output the 12.5 to 15 V row is used and with a $47\text{-}\mu\text{H}$ inductor there are three surface mount output capacitor solutions. [Table 1](#) provides the actual capacitor characteristics based on the C Code number. Any of the following choices can be used:

- $1 \times 33\text{-}\mu\text{F}$, 20-V AVX TPS (code C6)
- $1 \times 47\text{-}\mu\text{F}$, 20-V Sprague 594 (code C8)
- $1 \times 47\text{-}\mu\text{F}$, 20-V Kemet T495 (code C8)

NOTE

When using the adjustable device in low voltage applications (less than 3-V output), if the nomograph [Figure 20](#) selects an inductance of $22 \mu\text{H}$ or less [Table 9](#) and [Table 10](#) do not provide an output capacitor solution. With these conditions the number of output capacitors required for stable operation becomes impractical. TI recommends using either a $33\text{-}\mu\text{H}$ or $47\text{-}\mu\text{H}$ inductor and the output capacitors from [Table 9](#) and [Table 10](#).

Step 5: An input capacitor for this example requires at least a 35-V WV rating with an RMS current rating of 1.75 A ($1/2 I_{\text{OUT max}}$). [Table 1](#) shows that C12, a $33\text{-}\mu\text{F}$, 35-V capacitor from Sprague, has the highest voltage and current rating of the surface mount components and that two of these capacitor in parallel are adequate.

Step 6: From [Table 4](#) a 5-A or more Schottky diode must be selected. For surface mount diodes with a margin of safety on the voltage rating one of two diodes can be used:

- MBRD1545CT
- 6TQ045S

Step 7: A $0.01\text{-}\mu\text{F}$ capacitor is used for C_{BOOST} .

8.2.3.1.1 Capacitor Selection

Table 9. Output Capacitors for Adjustable Output Voltage Applications—Surface Mount⁽¹⁾⁽²⁾

| OUTPUT VOLTAGE (V) | INDUCTANCE (μH) | SURFACE MOUNT | | | | | |
|--------------------|------------------------------|----------------|--------|---------------------|--------|-------------------|--------|
| | | AVX TPS SERIES | | SPRAGUE 594D SERIES | | KEMET T495 SERIES | |
| | | NO. | C CODE | NO. | C CODE | NO. | C CODE |
| 1.21 to 2.5 | $33^{(3)}$ | 7 | C1 | 6 | C2 | 7 | C3 |
| | $47^{(3)}$ | 5 | C1 | 4 | C2 | 5 | C3 |
| 2.5 to 3.75 | $33^{(3)}$ | 4 | C1 | 3 | C2 | 4 | C3 |
| | $47^{(3)}$ | 3 | C1 | 2 | C2 | 3 | C3 |
| 3.75 to 5 | 22 | 4 | C1 | 3 | C2 | 4 | C3 |
| | 33 | 3 | C1 | 2 | C2 | 3 | C3 |
| | 47 | 2 | C1 | 2 | C2 | 2 | C3 |

(1) No. represents the number of identical capacitor types to be connected in parallel.

(2) C Code indicates the Capacitor Reference number in [Table 1](#) and [Table 2](#) for identifying the specific component from the manufacturer.

(3) Set to a higher value for a practical design solution.

Table 9. Output Capacitors for Adjustable Output Voltage Applications—Surface Mount⁽¹⁾⁽²⁾ (continued)

| OUTPUT VOLTAGE (V) | INDUCTANCE (μH) | SURFACE MOUNT | | | | | |
|--------------------|-----------------|---------------------|--------|---------------------|--------|-------------------|--------|
| | | AVX TPS SERIES | | SPRAGUE 594D SERIES | | KEMET T495 SERIES | |
| | | NO. | C CODE | NO. | C CODE | NO. | C CODE |
| 5 to 6.25 | 22 | 3 | C2 | 3 | C3 | 3 | C4 |
| | 33 | 2 | C2 | 2 | C3 | 2 | C4 |
| | 47 | 2 | C2 | 2 | C3 | 2 | C4 |
| | 68 | 1 | C2 | 1 | C3 | 1 | C4 |
| 6.25 to 7.5 | 22 | 3 | C2 | 1 | C4 | 3 | C4 |
| | 33 | 2 | C2 | 1 | C3 | 2 | C4 |
| | 47 | 1 | C3 | 1 | C4 | 1 | C6 |
| | 68 | 1 | C2 | 1 | C3 | 1 | C4 |
| 7.5 to 10 | 33 | 2 | C5 | 1 | C6 | 2 | C8 |
| | 47 | 1 | C5 | 1 | C6 | 2 | C8 |
| | 68 | 1 | C5 | 1 | C6 | 1 | C8 |
| | 100 | 1 | C4 | 1 | C5 | 1 | C8 |
| 10 to 12.5 | 33 | 1 | C5 | 1 | C6 | 2 | C8 |
| | 47 | 1 | C5 | 1 | C6 | 2 | C8 |
| | 68 | 1 | C5 | 1 | C6 | 1 | C8 |
| | 100 | 1 | C5 | 1 | C6 | 1 | C8 |
| 12.5 to 15 | 33 | 1 | C6 | 1 | C8 | 1 | C8 |
| | 47 | 1 | C6 | 1 | C8 | 1 | C8 |
| | 68 | 1 | C6 | 1 | C8 | 1 | C8 |
| | 100 | 1 | C6 | 1 | C8 | 1 | C8 |
| 15 to 20 | 33 | 1 | C8 | 1 | C10 | 2 | C10 |
| | 47 | 1 | C8 | 1 | C9 | 2 | C10 |
| | 68 | 1 | C8 | 1 | C9 | 2 | C10 |
| | 100 | 1 | C8 | 1 | C9 | 1 | C10 |
| 20 to 30 | 33 | 2 | C9 | 2 | C11 | 2 | C11 |
| | 47 | 1 | C10 | 1 | C12 | 1 | C11 |
| | 68 | 1 | C9 | 1 | C12 | 1 | C11 |
| | 100 | 1 | C9 | 1 | C12 | 1 | C11 |
| 30 to 37 | 10 | No values available | | 4 | C13 | 8 | C12 |
| | 15 | | | 3 | C13 | 5 | C12 |
| | 22 | | | 2 | C13 | 4 | C12 |
| | 33 | | | 1 | C13 | 3 | C12 |
| | 47 | | | 1 | C13 | 2 | C12 |
| | 68 | | | 1 | C13 | 2 | C12 |

Table 10. Output Capacitors for Adjustable Output Voltage Applications—Through Hole⁽¹⁾⁽²⁾

| OUTPUT VOLTAGE (V) | INDUCTANCE (μH) | THROUGH HOLE | | | | | | | |
|--------------------|-------------------|------------------------|--------|--------------------|--------|--------------------|--------|----------------------|--------|
| | | SANYO OS-CON SA SERIES | | SANYO MV-GX SERIES | | NICHICON PL SERIES | | PANASONIC HFQ SERIES | |
| | | NO. | C CODE | NO. | C CODE | NO. | C CODE | NO. | C CODE |
| 1.21 to 2.5 | 33 ⁽³⁾ | 2 | C3 | 5 | C1 | 5 | C3 | 3 | C |
| | 47 ⁽³⁾ | 2 | C2 | 4 | C1 | 3 | C3 | 2 | C5 |
| 2.5 to 3.75 | 33 ⁽³⁾ | 1 | C3 | 3 | C1 | 3 | C1 | 2 | C5 |
| | 47 ⁽³⁾ | 1 | C2 | 2 | C1 | 2 | C3 | 1 | C5 |
| 3.75 to 5 | 22 | 1 | C3 | 3 | C1 | 3 | C1 | 2 | C5 |
| | 33 | 1 | C2 | 2 | C1 | 2 | C1 | 1 | C5 |
| | 47 | 1 | C2 | 2 | C1 | 1 | C3 | 1 | C5 |
| 5 to 6.25 | 22 | 1 | C5 | 2 | C6 | 2 | C3 | 2 | C5 |
| | 33 | 1 | C4 | 1 | C6 | 2 | C1 | 1 | C5 |
| | 47 | 1 | C4 | 1 | C6 | 1 | C3 | 1 | C5 |
| | 68 | 1 | C4 | 1 | C6 | 1 | C1 | 1 | C5 |
| 6.25 to 7.5 | 22 | 1 | C5 | 1 | C6 | 2 | C1 | 1 | C5 |
| | 33 | 1 | C4 | 1 | C6 | 1 | C3 | 1 | C5 |
| | 47 | 1 | C4 | 1 | C6 | 1 | C1 | 1 | C5 |
| | 68 | 1 | C4 | 1 | C2 | 1 | C1 | 1 | C5 |
| 7.5 to 10 | 33 | 1 | C7 | 1 | C6 | 1 | C14 | 1 | C5 |
| | 47 | 1 | C7 | 1 | C6 | 1 | C14 | 1 | C5 |
| | 68 | 1 | C7 | 1 | C2 | 1 | C14 | 1 | C2 |
| | 100 | 1 | C7 | 1 | C2 | 1 | C14 | 1 | C2 |
| 10 to 12.5 | 33 | 1 | C7 | 1 | C6 | 1 | C14 | 1 | C5 |
| | 47 | 1 | C7 | 1 | C2 | 1 | C14 | 1 | C5 |
| | 68 | 1 | C7 | 1 | C2 | 1 | C9 | 1 | C2 |
| | 100 | 1 | C7 | 1 | C2 | 1 | C9 | 1 | C2 |
| 12.5 to 15 | 33 | 1 | C9 | 1 | C10 | 1 | C15 | 1 | C2 |
| | 47 | 1 | C9 | 1 | C10 | 1 | C15 | 1 | C2 |
| | 68 | 1 | C9 | 1 | C10 | 1 | C15 | 1 | C2 |
| | 100 | 1 | C9 | 1 | C10 | 1 | C15 | 1 | C2 |
| 15 to 20 | 33 | 1 | C10 | 1 | C7 | 1 | C15 | 1 | C2 |
| | 47 | 1 | C10 | 1 | C7 | 1 | C15 | 1 | C2 |
| | 68 | 1 | C10 | 1 | C7 | 1 | C15 | 1 | C2 |
| | 100 | 1 | C10 | 1 | C7 | 1 | C15 | 1 | C2 |
| 20 to 30 | 33 | No values available | | 1 | C7 | 1 | C16 | 1 | C2 |
| | 47 | | | 1 | C7 | 1 | C16 | 1 | C2 |
| | 68 | | | 1 | C7 | 1 | C16 | 1 | C2 |
| | 100 | | | 1 | C7 | 1 | C16 | 1 | C2 |
| 30 to 37 | 10 | No values available | | 1 | C12 | 1 | C20 | 1 | C10 |
| | 15 | | | 1 | C11 | 1 | C20 | 1 | C11 |
| | 22 | | | 1 | C11 | 1 | C20 | 1 | C10 |
| | 33 | | | 1 | C11 | 1 | C20 | 1 | C10 |
| | 47 | | | 1 | C11 | 1 | C20 | 1 | C10 |
| | 68 | | | 1 | C11 | 1 | C20 | 1 | C10 |

(1) No. represents the number of identical capacitor types to be connected in parallel.

(2) C Code indicates the Capacitor Reference number in [Table 1](#) and [Table 2](#) for identifying the specific component from the manufacturer.

(3) Set to a higher value for a practical design solution.

9 Power Supply Recommendations

The LM2678 is designed to operate from an input voltage supply up to 40 V. This input supply must be well regulated and able to withstand maximum input current and maintain a stable voltage.

10 Layout

10.1 Layout Guidelines

Board layout is critical for the proper operation of switching power supplies. First, the ground plane area must be sufficient for thermal dissipation purposes. Second, appropriate guidelines must be followed to reduce the effects of switching noise. Switch mode converters are very fast switching devices. In such cases, the rapid increase of input current combined with the parasitic trace inductance generates unwanted $L di/dt$ noise spikes. The magnitude of this noise tends to increase as the output current increases. This noise may turn into electromagnetic interference (EMI) and can also cause problems in device performance. Therefore, take care in layout to minimize the effect of this switching noise. The most important layout rule is to keep the AC current loops as small as possible. [Figure 23](#) shows the current flow in a buck converter. The top schematic shows a dotted line which represents the current flow during the top switch ON-state. The middle schematic shows the current flow during the top switch OFF-state. The bottom schematic shows the currents referred to as AC currents. These AC currents are the most critical because they are changing in a very short time period. The dotted lines of the bottom schematic are the traces to keep as short and wide as possible. This will also yield a small loop area reducing the loop inductance. To avoid functional problems due to layout, review the PCB layout example. Best results are achieved if the placement of the LM2679 device, the bypass capacitor, the Schottky diode, RFBB, RFBT, and the inductor are placed as shown in the example. Note that, in the layout shown, R1 = RFBB and R2 = RFBT. It is also recommended to use 2-oz. copper boards or heavier to help thermal dissipation and to reduce the parasitic inductances of board traces. See [AN-1229 SIMPLE SWITCHER® PCB Layout Guidelines](#) for more information.

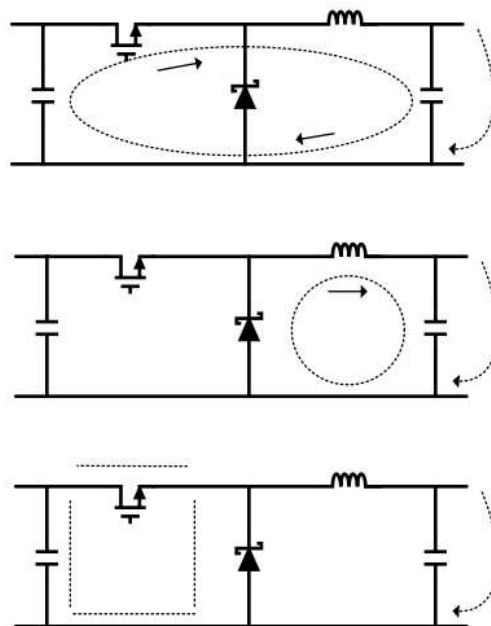

Figure 23. Typical Current Flow in Buck Regulator

10.2 Layout Example

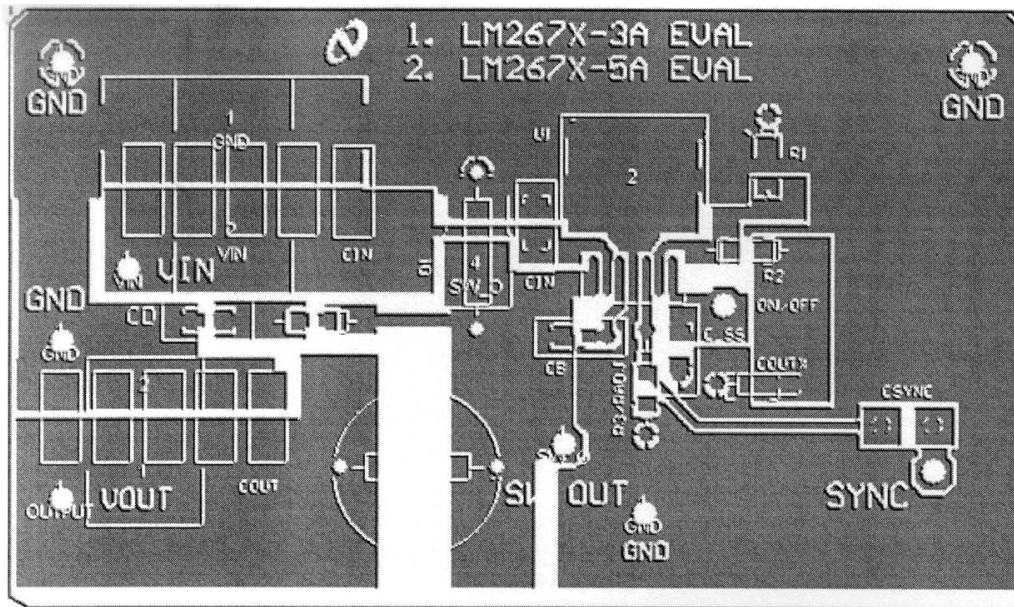

Figure 24. Top Layer Foil Pattern of Printed-Circuit Board

11 Device and Documentation Support

11.1 Custom Design With WEBENCH® Tools

[Click here](#) to create a custom design using the LM2678 device with the WEBENCH® Power Designer.

1. Start by entering the input voltage (V_{IN}), output voltage (V_{OUT}), and output current (I_{OUT}) requirements.
2. Optimize the design for key parameters such as efficiency, footprint, and cost using the optimizer dial.
3. Compare the generated design with other possible solutions from Texas Instruments.

The WEBENCH Power Designer provides a customized schematic along with a list of materials with real-time pricing and component availability.

In most cases, these actions are available:

- Run electrical simulations to see important waveforms and circuit performance
- Run thermal simulations to understand board thermal performance
- Export customized schematic and layout into popular CAD formats
- Print PDF reports for the design, and share the design with colleagues

Get more information about WEBENCH tools at www.ti.com/WEBENCH.

11.2 Related Documentation

For related documentation see the following:

- [AN-1187 Leadless Leadframe Package \(LLP\)](#) (SNOA401)
- [AN-1229 SIMPLE SWITCHER® PCB Layout Guidelines](#) (SNVA054)

11.3 Receiving Notification of Documentation Updates

To receive notification of documentation updates, navigate to the device product folder on ti.com. In the upper right corner, click on *Alert me* to register and receive a weekly digest of any product information that has changed. For change details, review the revision history included in any revised document.

11.4 Community Resources

The following links connect to TI community resources. Linked contents are provided "AS IS" by the respective contributors. They do not constitute TI specifications and do not necessarily reflect TI's views; see TI's [Terms of Use](#).

TI E2E™ Online Community *TI's Engineer-to-Engineer (E2E) Community*. Created to foster collaboration among engineers. At e2e.ti.com, you can ask questions, share knowledge, explore ideas and help solve problems with fellow engineers.

Design Support *TI's Design Support* Quickly find helpful E2E forums along with design support tools and contact information for technical support.

11.5 Trademarks

E2E is a trademark of Texas Instruments.

SIMPLE SWITCHER, WEBENCH are registered trademarks of Texas Instruments.

All other trademarks are the property of their respective owners.

11.6 Electrostatic Discharge Caution



These devices have limited built-in ESD protection. The leads should be shorted together or the device placed in conductive foam during storage or handling to prevent electrostatic damage to the MOS gates.

11.7 Glossary

[SLYZ022](#) — *TI Glossary*.

This glossary lists and explains terms, acronyms, and definitions.

12 Mechanical, Packaging, and Orderable Information

The following pages include mechanical, packaging, and orderable information. This information is the most current data available for the designated devices. This data is subject to change without notice and revision of this document. For browser-based versions of this data sheet, refer to the left-hand navigation.

12.1 VSON Package Devices

The LM2678 is offered in the 14-pin VSON surface mount package to allow for a significantly decreased footprint with equivalent power dissipation compared to the DDPAK. For details on mounting and soldering specifications, refer to [AN-1187 Leadless Leadfram Package \(LLP\)](#).

PACKAGING INFORMATION

| Orderable Device | Status (1) | Package Type | Package Drawing | Pins | Package Qty | Eco Plan (2) | Lead/Ball Finish (6) | MSL Peak Temp (3) | Op Temp (°C) | Device Marking (4/5) | Samples |
|--------------------|---------------|------------------|--------------------|------|----------------|----------------------------|-------------------------|----------------------|--------------|-------------------------|-------------------------|
| LM2678S-12 | NRND | DDPAK/ TO-263 | KTW | 7 | 45 | TBD | Call TI | Call TI | -40 to 125 | LM2678 S-12 | |
| LM2678S-12/NOPB | ACTIVE | DDPAK/ TO-263 | KTW | 7 | 45 | Pb-Free (RoHS Exempt) | CU SN | Level-3-245C-168 HR | -40 to 125 | LM2678 S-12 | Samples |
| LM2678S-3.3 | NRND | DDPAK/ TO-263 | KTW | 7 | 45 | TBD | Call TI | Call TI | -40 to 125 | LM2678 S-3.3 | |
| LM2678S-3.3/NOPB | ACTIVE | DDPAK/ TO-263 | KTW | 7 | 45 | Pb-Free (RoHS Exempt) | CU SN | Level-3-245C-168 HR | -40 to 125 | LM2678 S-3.3 | Samples |
| LM2678S-5.0 | NRND | DDPAK/ TO-263 | KTW | 7 | 45 | TBD | Call TI | Call TI | -40 to 125 | LM2678 S-5.0 | |
| LM2678S-5.0/NOPB | ACTIVE | DDPAK/ TO-263 | KTW | 7 | 45 | Pb-Free (RoHS Exempt) | CU SN | Level-3-245C-168 HR | -40 to 125 | LM2678 S-5.0 | Samples |
| LM2678S-ADJ | NRND | DDPAK/ TO-263 | KTW | 7 | 45 | TBD | Call TI | Call TI | -40 to 125 | LM2678 S-ADJ | |
| LM2678S-ADJ/NOPB | ACTIVE | DDPAK/ TO-263 | KTW | 7 | 45 | Pb-Free (RoHS Exempt) | CU SN | Level-3-245C-168 HR | -40 to 125 | LM2678 S-ADJ | Samples |
| LM2678SD-12 | NRND | VSON | NHM | 14 | 250 | TBD | Call TI | Call TI | -40 to 125 | S0003BB | |
| LM2678SD-12/NOPB | ACTIVE | VSON | NHM | 14 | 250 | Green (RoHS & no Sb/Br) | CU SN | Level-1-260C-UNLIM | -40 to 125 | S0003BB | Samples |
| LM2678SD-3.3/NOPB | ACTIVE | VSON | NHM | 14 | 250 | Green (RoHS & no Sb/Br) | CU SN | Level-1-260C-UNLIM | -40 to 125 | S0003CB | Samples |
| LM2678SD-5.0/NOPB | ACTIVE | VSON | NHM | 14 | 250 | Green (RoHS & no Sb/Br) | CU SN | Level-1-260C-UNLIM | -40 to 125 | S0003DB | Samples |
| LM2678SD-ADJ/NOPB | ACTIVE | VSON | NHM | 14 | 250 | Green (RoHS & no Sb/Br) | CU SN | Level-1-260C-UNLIM | -40 to 125 | S0003EB | Samples |
| LM2678SDX-3.3/NOPB | ACTIVE | VSON | NHM | 14 | 2500 | Green (RoHS & no Sb/Br) | CU SN | Level-1-260C-UNLIM | -40 to 125 | S0003CB | Samples |
| LM2678SDX-5.0/NOPB | ACTIVE | VSON | NHM | 14 | 2500 | Green (RoHS & no Sb/Br) | CU SN | Level-1-260C-UNLIM | -40 to 125 | S0003DB | Samples |
| LM2678SDX-ADJ/NOPB | ACTIVE | VSON | NHM | 14 | 2500 | Green (RoHS & no Sb/Br) | CU SN | Level-1-260C-UNLIM | -40 to 125 | S0003EB | Samples |
| LM2678SX-12/NOPB | ACTIVE | DDPAK/ TO-263 | KTW | 7 | 500 | Pb-Free (RoHS Exempt) | CU SN | Level-3-245C-168 HR | -40 to 125 | LM2678 S-12 | Samples |

| Orderable Device | Status (1) | Package Type | Package Drawing | Pins | Package Qty | Eco Plan (2) | Lead/Ball Finish (6) | MSL Peak Temp (3) | Op Temp (°C) | Device Marking (4/5) | Samples |
|-------------------|---------------|------------------|-----------------|------|-------------|----------------------------|-------------------------|----------------------|--------------|-------------------------|-------------------------|
| LM2678SX-3.3/NOPB | ACTIVE | DDPAK/ TO-263 | KTW | 7 | 500 | Pb-Free (RoHS Exempt) | CU SN | Level-3-245C-168 HR | -40 to 125 | LM2678 S-3.3 | Samples |
| LM2678SX-5.0/NOPB | ACTIVE | DDPAK/ TO-263 | KTW | 7 | 500 | Pb-Free (RoHS Exempt) | CU SN | Level-3-245C-168 HR | -40 to 125 | LM2678 S-5.0 | Samples |
| LM2678SX-ADJ | NRND | DDPAK/ TO-263 | KTW | 7 | 500 | TBD | Call TI | Call TI | -40 to 125 | LM2678 S-ADJ | |
| LM2678SX-ADJ/NOPB | ACTIVE | DDPAK/ TO-263 | KTW | 7 | 500 | Pb-Free (RoHS Exempt) | CU SN | Level-3-245C-168 HR | -40 to 125 | LM2678 S-ADJ | Samples |
| LM2678T-12/NOPB | ACTIVE | TO-220 | NDZ | 7 | 45 | Green (RoHS & no Sb/Br) | CU SN | Level-1-NA-UNLIM | -40 to 125 | LM2678 T-12 | Samples |
| LM2678T-3.3/NOPB | ACTIVE | TO-220 | NDZ | 7 | 45 | Green (RoHS & no Sb/Br) | CU SN | Level-1-NA-UNLIM | -40 to 125 | LM2678 T-3.3 | Samples |
| LM2678T-5.0 | NRND | TO-220 | NDZ | 7 | 45 | TBD | Call TI | Call TI | -40 to 125 | LM2678 T-5.0 | |
| LM2678T-5.0/NOPB | ACTIVE | TO-220 | NDZ | 7 | 45 | Green (RoHS & no Sb/Br) | CU SN | Level-1-NA-UNLIM | -40 to 125 | LM2678 T-5.0 | Samples |
| LM2678T-ADJ | NRND | TO-220 | NDZ | 7 | 45 | TBD | Call TI | Call TI | -40 to 125 | LM2678 T-ADJ | |
| LM2678T-ADJ/NOPB | ACTIVE | TO-220 | NDZ | 7 | 45 | Green (RoHS & no Sb/Br) | CU SN | Level-1-NA-UNLIM | -40 to 125 | LM2678 T-ADJ | Samples |

(1) The marketing status values are defined as follows:

ACTIVE: Product device recommended for new designs.

LIFEBUY: TI has announced that the device will be discontinued, and a lifetime-buy period is in effect.

NRND: Not recommended for new designs. Device is in production to support existing customers, but TI does not recommend using this part in a new design.

PREVIEW: Device has been announced but is not in production. Samples may or may not be available.

OBSELETE: TI has discontinued the production of the device.

(2) **RoHS:** TI defines "RoHS" to mean semiconductor products that are compliant with the current EU RoHS requirements for all 10 RoHS substances, including the requirement that RoHS substance do not exceed 0.1% by weight in homogeneous materials. Where designed to be soldered at high temperatures, "RoHS" products are suitable for use in specified lead-free processes. TI may reference these types of products as "Pb-Free".

RoHS Exempt: TI defines "RoHS Exempt" to mean products that contain lead but are compliant with EU RoHS pursuant to a specific EU RoHS exemption.

Green: TI defines "Green" to mean the content of Chlorine (Cl) and Bromine (Br) based flame retardants meet JS709B low halogen requirements of <=1000ppm threshold. Antimony trioxide based flame retardants must also meet the <=1000ppm threshold requirement.

(3) MSL, Peak Temp. - The Moisture Sensitivity Level rating according to the JEDEC industry standard classifications, and peak solder temperature.

(4) There may be additional marking, which relates to the logo, the lot trace code information, or the environmental category on the device.

(5) Multiple Device Markings will be inside parentheses. Only one Device Marking contained in parentheses and separated by a "~" will appear on a device. If a line is indented then it is a continuation of the previous line and the two combined represent the entire Device Marking for that device.

(6) Lead/Ball Finish - Orderable Devices may have multiple material finish options. Finish options are separated by a vertical ruled line. Lead/Ball Finish values may wrap to two lines if the finish value exceeds the maximum column width.

Important Information and Disclaimer:The information provided on this page represents TI's knowledge and belief as of the date that it is provided. TI bases its knowledge and belief on information provided by third parties, and makes no representation or warranty as to the accuracy of such information. Efforts are underway to better integrate information from third parties. TI has taken and continues to take reasonable steps to provide representative and accurate information but may not have conducted destructive testing or chemical analysis on incoming materials and chemicals. TI and TI suppliers consider certain information to be proprietary, and thus CAS numbers and other limited information may not be available for release.

In no event shall TI's liability arising out of such information exceed the total purchase price of the TI part(s) at issue in this document sold by TI to Customer on an annual basis.

TAPE AND REEL INFORMATION



QUADRANT ASSIGNMENTS FOR PIN 1 ORIENTATION IN TAPE



*All dimensions are nominal

| Device | Package Type | Package Drawing | Pins | SPQ | Reel Diameter (mm) | Reel Width W1 (mm) | A0 (mm) | B0 (mm) | K0 (mm) | P1 (mm) | W (mm) | Pin1 Quadrant |
|--------------------|------------------|-----------------|------|------|--------------------|--------------------|---------|---------|---------|---------|--------|---------------|
| LM2678SD-12 | VSON | NHM | 14 | 250 | 178.0 | 16.4 | 5.3 | 6.3 | 1.5 | 12.0 | 16.0 | Q1 |
| LM2678SD-12/NOPB | VSON | NHM | 14 | 250 | 178.0 | 16.4 | 5.3 | 6.3 | 1.5 | 12.0 | 16.0 | Q1 |
| LM2678SD-3.3/NOPB | VSON | NHM | 14 | 250 | 178.0 | 16.4 | 5.3 | 6.3 | 1.5 | 12.0 | 16.0 | Q1 |
| LM2678SD-5.0/NOPB | VSON | NHM | 14 | 250 | 178.0 | 16.4 | 5.3 | 6.3 | 1.5 | 12.0 | 16.0 | Q1 |
| LM2678SD-ADJ/NOPB | VSON | NHM | 14 | 250 | 178.0 | 16.4 | 5.3 | 6.3 | 1.5 | 12.0 | 16.0 | Q1 |
| LM2678SDX-3.3/NOPB | VSON | NHM | 14 | 2500 | 330.0 | 16.4 | 5.3 | 6.3 | 1.5 | 12.0 | 16.0 | Q1 |
| LM2678SDX-5.0/NOPB | VSON | NHM | 14 | 2500 | 330.0 | 16.4 | 5.3 | 6.3 | 1.5 | 12.0 | 16.0 | Q1 |
| LM2678SDX-ADJ/NOPB | VSON | NHM | 14 | 2500 | 330.0 | 16.4 | 5.3 | 6.3 | 1.5 | 12.0 | 16.0 | Q1 |
| LM2678SX-12/NOPB | DDPAK/ TO-263 | KTW | 7 | 500 | 330.0 | 24.4 | 10.75 | 14.85 | 5.0 | 16.0 | 24.0 | Q2 |
| LM2678SX-3.3/NOPB | DDPAK/ TO-263 | KTW | 7 | 500 | 330.0 | 24.4 | 10.75 | 14.85 | 5.0 | 16.0 | 24.0 | Q2 |
| LM2678SX-5.0/NOPB | DDPAK/ TO-263 | KTW | 7 | 500 | 330.0 | 24.4 | 10.75 | 14.85 | 5.0 | 16.0 | 24.0 | Q2 |
| LM2678SX-ADJ | DDPAK/ TO-263 | KTW | 7 | 500 | 330.0 | 24.4 | 10.75 | 14.85 | 5.0 | 16.0 | 24.0 | Q2 |
| LM2678SX-ADJ/NOPB | DDPAK/ TO-263 | KTW | 7 | 500 | 330.0 | 24.4 | 10.75 | 14.85 | 5.0 | 16.0 | 24.0 | Q2 |

TAPE AND REEL BOX DIMENSIONS



*All dimensions are nominal

| Device | Package Type | Package Drawing | Pins | SPQ | Length (mm) | Width (mm) | Height (mm) |
|--------------------|--------------|-----------------|------|------|-------------|------------|-------------|
| LM2678SD-12 | VSON | NHM | 14 | 250 | 210.0 | 185.0 | 35.0 |
| LM2678SD-12/NOPB | VSON | NHM | 14 | 250 | 210.0 | 185.0 | 35.0 |
| LM2678SD-3.3/NOPB | VSON | NHM | 14 | 250 | 210.0 | 185.0 | 35.0 |
| LM2678SD-5.0/NOPB | VSON | NHM | 14 | 250 | 210.0 | 185.0 | 35.0 |
| LM2678SD-ADJ/NOPB | VSON | NHM | 14 | 250 | 210.0 | 185.0 | 35.0 |
| LM2678SDX-3.3/NOPB | VSON | NHM | 14 | 2500 | 367.0 | 367.0 | 35.0 |
| LM2678SDX-5.0/NOPB | VSON | NHM | 14 | 2500 | 367.0 | 367.0 | 35.0 |
| LM2678SDX-ADJ/NOPB | VSON | NHM | 14 | 2500 | 367.0 | 367.0 | 35.0 |
| LM2678SX-12/NOPB | DDPAK/TO-263 | KTW | 7 | 500 | 367.0 | 367.0 | 45.0 |
| LM2678SX-3.3/NOPB | DDPAK/TO-263 | KTW | 7 | 500 | 367.0 | 367.0 | 45.0 |
| LM2678SX-5.0/NOPB | DDPAK/TO-263 | KTW | 7 | 500 | 367.0 | 367.0 | 45.0 |
| LM2678SX-ADJ | DDPAK/TO-263 | KTW | 7 | 500 | 367.0 | 367.0 | 45.0 |
| LM2678SX-ADJ/NOPB | DDPAK/TO-263 | KTW | 7 | 500 | 367.0 | 367.0 | 45.0 |

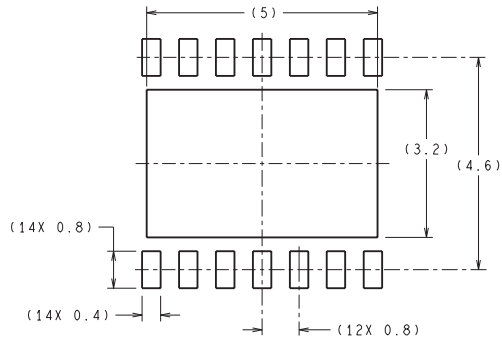
NHM0014A

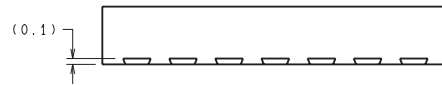

DIMENSIONS ARE IN MILLIMETERS
DIMENSIONS IN () FOR REFERENCE ONLY



RECOMMENDED LAND PATTERN

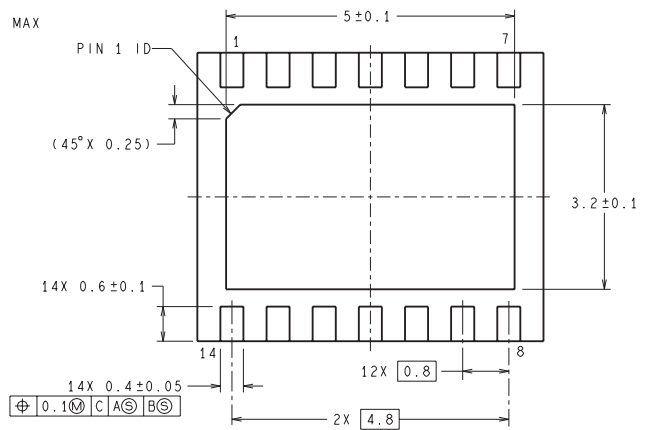
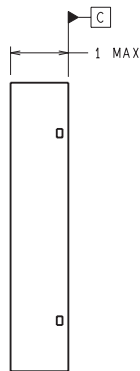
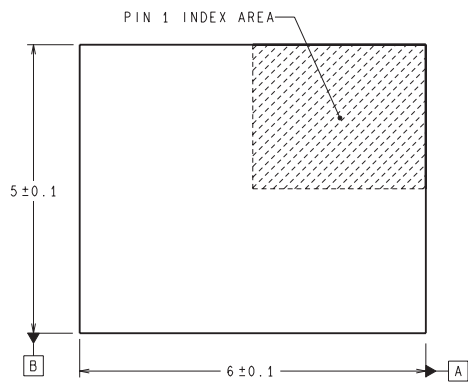

SRC14A (Rev A)

IMPORTANT NOTICE AND DISCLAIMER

TI PROVIDES TECHNICAL AND RELIABILITY DATA (INCLUDING DATASHEETS), DESIGN RESOURCES (INCLUDING REFERENCE DESIGNS), APPLICATION OR OTHER DESIGN ADVICE, WEB TOOLS, SAFETY INFORMATION, AND OTHER RESOURCES "AS IS" AND WITH ALL FAULTS, AND DISCLAIMS ALL WARRANTIES, EXPRESS AND IMPLIED, INCLUDING WITHOUT LIMITATION ANY IMPLIED WARRANTIES OF MERCHANTABILITY, FITNESS FOR A PARTICULAR PURPOSE OR NON-INFRINGEMENT OF THIRD PARTY INTELLECTUAL PROPERTY RIGHTS.



These resources are intended for skilled developers designing with TI products. You are solely responsible for (1) selecting the appropriate TI products for your application, (2) designing, validating and testing your application, and (3) ensuring your application meets applicable standards, and any other safety, security, or other requirements. These resources are subject to change without notice. TI grants you permission to use these resources only for development of an application that uses the TI products described in the resource. Other reproduction and display of these resources is prohibited. No license is granted to any other TI intellectual property right or to any third party intellectual property right. TI disclaims responsibility for, and you will fully indemnify TI and its representatives against, any claims, damages, costs, losses, and liabilities arising out of your use of these resources.

TI's products are provided subject to TI's Terms of Sale (www.ti.com/legal/termsofsale.html) or other applicable terms available either on ti.com or provided in conjunction with such TI products. TI's provision of these resources does not expand or otherwise alter TI's applicable warranties or warranty disclaimers for TI products.

Mailing Address: Texas Instruments, Post Office Box 655303, Dallas, Texas 75265
Copyright © 2019, Texas Instruments Incorporated

Looking for pricing, stock, or lifecycle information?

Click below to explore more details on WIN SOURCE:

-  [View LM2678SDX-ADJ/NOPB on WIN SOURCE](#)
-  [Texas Instruments](#) Information

Optimize Your Supply Chain with WIN SOURCE Solutions

-  Global Sourcing Solution
-  Obsolete Management
-  Cost Control Management
-  Shortage Management
-  Alternative Solution
-  Excess Inventory Management