



## LM4128/LM4128Q SOT-23 Precision Micropower Series Voltage Reference

Check for Samples: [LM4128](#), [LM4128Q](#)

### FEATURES

- Output Voltage Initial Accuracy 0.1%
- Low Temperature Coefficient 75 ppm/°C
- Low Supply Current, 60  $\mu$ A
- Enable Pin Allowing a 3  $\mu$ A Shutdown Mode
- Up to 20 mA Output Current
- Voltage Options 1.8V, 2.048V, 2.5V, 3.0V, 3.3V, 4.096V
- Custom Voltage Options Available (1.8V to 4.096V)
- $V_{IN}$  Range of  $V_{REF} + 400$  mV to 5.5V @10 mA
- Stable with Low ESR Ceramic Capacitors
- 5-Pin SOT-23 Package
- -40°C to 125°C Junction Temperature Range
- LM4128AQ/BQ/CQ/DQ are AEC-Q100 Grade 1 Qualified and are Manufactured on an Automotive Grade Flow

### APPLICATIONS

- Instrumentation & Process Control
- Test Equipment
- Data Acquisition Systems
- Base Stations
- Servo Systems
- Portable, Battery Powered Equipment
- Automotive & Industrial Electronics
- Precision Regulators
- Battery Chargers
- Communications
- Medical Equipment

### DESCRIPTION

Ideal for space critical applications, the LM4128 precision voltage reference is available in the SOT-23 surface-mount package. The LM4128's advanced design eliminates the need for an external stabilizing capacitor while ensuring stability with capacitive loads up to 10  $\mu$ F, thus making the LM4128 easy to use.

Series references provide lower power consumption than shunt references, since they do not have to idle the maximum possible load current under no load conditions. This advantage, the low quiescent current (60  $\mu$ A), and the low dropout voltage (400 mV) make the LM4128 ideal for battery-powered solutions.

The LM4128 is available in four grades (A, B, C, and D) for greater flexibility. The best grade devices (A) have an initial accuracy of 0.1% with ensured temperature coefficient of 75 ppm/°C or less, while the lowest grade parts (D) have an initial accuracy of 1.0% and a tempco of 100 ppm/°C.

### Typical Application Circuit

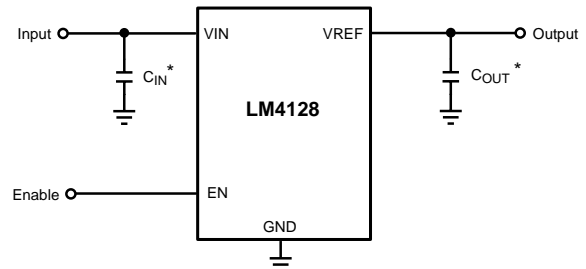

\*Note: The capacitor  $C_{IN}$  is required and the capacitor  $C_{OUT}$  is optional.



Please be aware that an important notice concerning availability, standard warranty, and use in critical applications of Texas Instruments semiconductor products and disclaimers thereto appears at the end of this data sheet.

All trademarks are the property of their respective owners.

## Connection Diagram



**5-Pin SOT-23 Package – Top View**  
See Package Number DBV (R-PDSO-G5)

### PIN DESCRIPTIONS

Pin #	Name	Function
1	N/C	No connect pin, leave floating
2	GND	Ground
3	EN	Enable pin
4	VIN	Input supply
5	VREF	Reference output



These devices have limited built-in ESD protection. The leads should be shorted together or the device placed in conductive foam during storage or handling to prevent electrostatic damage to the MOS gates.

### Absolute Maximum Ratings<sup>(1)</sup>

Maximum Voltage on any input		-0.3 to 6V
Output short circuit duration		Indefinite
Power Dissipation ( $T_A = 25^\circ\text{C}$ ) <sup>(2)</sup>		350 mW
Storage Temperature Range		-65°C to 150°C
Lead Temperature	(soldering, 10sec)	260°C
	Vapor Phase (60 sec)	215°C
	Infrared (15sec)	220°C
ESD Susceptibility <sup>(3)</sup>	Human Body Model	2 kV

- (1) Absolute Maximum Ratings indicate limits beyond which damage may occur to the device. Operating Ratings indicate conditions for which the device is intended to be functional, but do not ensure specific performance limits. For ensured specifications, see Electrical Characteristics.
- (2) Without PCB copper enhancements. The maximum power dissipation must be de-rated at elevated temperatures and is limited by  $T_{JMAX}$  (maximum junction temperature),  $\theta_{J-A}$  (junction to ambient thermal resistance) and  $T_A$  (ambient temperature). The maximum power dissipation at any temperature is:  $P_{DissMAX} = (T_{JMAX} - T_A) / \theta_{J-A}$  up to the value listed in the Absolute Maximum Ratings.  $\theta_{J-A}$  for SOT-23 package is 220°C/W,  $T_{JMAX} = 125^\circ\text{C}$ .
- (3) The human body model is a 100 pF capacitor discharged through a 1.5 kΩ resistor into each pin.

### Operating Ratings

Maximum Input Supply Voltage	5.5V
Maximum Enable Input Voltage	$V_{IN}$
Maximum Load Current	20mA
Junction Temperature Range ( $T_J$ )	-40°C to +125°C

## Electrical Characteristics

### LM4128-1.8 (V<sub>OUT</sub> = 1.8V)

Limits in standard type are for T<sub>J</sub> = 25°C only, and limits in **boldface type** apply over the junction temperature (T<sub>J</sub>) range of -40°C to +125°C unless otherwise specified. Minimum and Maximum limits are ensured through test, design, or statistical correlation. Typical values represent the most likely parametric norm at T<sub>J</sub> = 25°C, and are provided for reference purposes only. Unless otherwise specified V<sub>IN</sub> = 5V and I<sub>LOAD</sub> = 0A.

Symbol	Parameter	Conditions	Min <sup>(1)</sup>	Typ <sup>(2)</sup>	Max <sup>(1)</sup>	Unit
V <sub>REF</sub>	Output Voltage Initial Accuracy					
	LM4128A-1.8	(A Grade - 0.1%)	-0.1		+0.1	%
	LM4128B-1.8	(B Grade - 0.2%)	-0.2		+0.2	
	LM4128C-1.8	(C Grade - 0.5%)	-0.5		+0.5	
LM4128D-1.8	(D Grade - 1.0%)	-1.0		+1.0		
TCV <sub>REF</sub> / °C <sup>(3)</sup>	Temperature Coefficient	LM4128A-1.8			<b>75</b>	ppm / °C
		LM4128B-1.8			<b>75</b>	
		LM4128C-1.8			<b>100</b>	
		LM4128D-1.8			<b>100</b>	
I <sub>Q</sub>	Supply Current			60	<b>100</b>	μA
I <sub>Q_SD</sub>	Supply Current in Shutdown	EN = 0V		3	<b>7</b>	μA
ΔV <sub>REF</sub> /ΔV <sub>IN</sub>	Line Regulation	V <sub>REF</sub> + 400 mV ≤ V <sub>IN</sub> ≤ 5.5V		30		ppm / V
ΔV <sub>REF</sub> /ΔI <sub>LOAD</sub>	Load Regulation	0 mA ≤ I <sub>LOAD</sub> ≤ 20 mA		25	<b>120</b>	ppm / mA
ΔV <sub>REF</sub>	Long Term Stability <sup>(4)</sup>	1000 Hrs		50		ppm
	Thermal Hysteresis <sup>(5)</sup>	-40°C ≤ T <sub>J</sub> ≤ +125°C		75		
V <sub>IN</sub> - V <sub>REF</sub>	Dropout Voltage <sup>(6)</sup>	I <sub>LOAD</sub> = 10 mA		200	<b>400</b>	mV
V <sub>N</sub>	Output Noise Voltage	0.1 Hz to 10 Hz		170		μV <sub>PP</sub>
I <sub>SC</sub>	Short Circuit Current				<b>75</b>	mA
V <sub>IL</sub>	Enable Pin Maximum Low Input Level				<b>35</b>	%V
V <sub>IH</sub>	Enable Pin Minimum High Input Level		<b>65</b>			%V

- (1) Limits are 100% production tested at 25°C. Limits over the operating temperature range are ensured through correlation using Statistical Quality Control.
- (2) Typical numbers are at 25°C and represent the most likely parametric norm.
- (3) Temperature coefficient is measured by the "Box" method; i.e., the maximum ΔV<sub>REF</sub> is divided by the maximum ΔT.
- (4) Long term stability is V<sub>REF</sub> @25°C measured during 1000 hrs.
- (5) Thermal hysteresis is defined as the change in +25°C output voltage before and after cycling the device from (-40°C to 125°C).
- (6) Dropout voltage is defined as the minimum input to output differential at which the output voltage drops by 0.5% below the value measured with a 5V input.

## Electrical Characteristics

### LM4128-2.0 ( $V_{OUT} = 2.048V$ )

Limits in standard type are for  $T_J = 25^\circ C$  only, and limits in **boldface type** apply over the junction temperature ( $T_J$ ) range of -40°C to +125°C unless otherwise specified. Minimum and Maximum limits are ensured through test, design, or statistical correlation. Typical values represent the most likely parametric norm at  $T_J = 25^\circ C$ , and are provided for reference purposes only. Unless otherwise specified  $V_{IN} = 5V$  and  $I_{LOAD} = 0A$ .

Symbol	Parameter	Conditions	Min <sup>(1)</sup>	Typ <sup>(2)</sup>	Max <sup>(1)</sup>	Unit
$V_{REF}$	Output Voltage Initial Accuracy					
	LM4128A-2.0	(A Grade - 0.1%)	-0.1		+0.1	%
	LM4128B-2.0	(B Grade - 0.2%)	-0.2		+0.2	
	LM4128C-2.0	(C Grade - 0.5%)	-0.5		+0.5	
LM4128D-2.0	(D Grade - 1.0%)	-1.0		+1.0		
$TCV_{REF} / ^\circ C^{(3)}$	Temperature Coefficient	LM4128A-2.0			<b>75</b>	ppm / °C
		LM4128B-2.0			<b>75</b>	
		LM4128C-2.0			<b>100</b>	
		LM4128D-2.0			<b>100</b>	
$I_Q$	Supply Current			60	<b>100</b>	$\mu A$
$I_{Q\_SD}$	Supply Current in Shutdown	EN = 0V		3	<b>7</b>	$\mu A$
$\Delta V_{REF}/\Delta V_{IN}$	Line Regulation	$V_{REF} + 400\text{ mV} \leq V_{IN} \leq 5.5V$		30		ppm / V
$\Delta V_{REF}/\Delta I_{LOAD}$	Load Regulation	$0\text{ mA} \leq I_{LOAD} \leq 20\text{ mA}$		25	<b>120</b>	ppm / mA
$\Delta V_{REF}$	Long Term Stability <sup>(4)</sup>	1000 Hrs		50		ppm
	Thermal Hysteresis <sup>(5)</sup>	$-40^\circ C \leq T_J \leq +125^\circ C$		75		
$V_{IN} - V_{REF}$	Dropout Voltage <sup>(6)</sup>	$I_{LOAD} = 10\text{ mA}$		175	<b>400</b>	mV
$V_N$	Output Noise Voltage	0.1 Hz to 10 Hz		190		$\mu V_{PP}$
$I_{SC}$	Short Circuit Current				<b>75</b>	mA
$V_{IL}$	Enable Pin Maximum Low Input Level				<b>35</b>	%V
$V_{IH}$	Enable Pin Minimum High Input Level		<b>65</b>			%V

- (1) Limits are 100% production tested at 25°C. Limits over the operating temperature range are ensured through correlation using Statistical Quality Control.
- (2) Typical numbers are at 25°C and represent the most likely parametric norm.
- (3) Temperature coefficient is measured by the "Box" method; i.e., the maximum  $\Delta V_{REF}$  is divided by the maximum  $\Delta T$ .
- (4) Long term stability is  $V_{REF}$  @25°C measured during 1000 hrs.
- (5) Thermal hysteresis is defined as the change in +25°C output voltage before and after cycling the device from (-40°C to 125°C).
- (6) Dropout voltage is defined as the minimum input to output differential at which the output voltage drops by 0.5% below the value measured with a 5V input.

## Electrical Characteristics

### LM4128-2.5 (V<sub>OUT</sub> = 2.5V)

Limits in standard type are for T<sub>J</sub> = 25°C only, and limits in **boldface type** apply over the junction temperature (T<sub>J</sub>) range of -40°C to +125°C unless otherwise specified. Minimum and Maximum limits are ensured through test, design, or statistical correlation. Typical values represent the most likely parametric norm at T<sub>J</sub> = 25°C, and are provided for reference purposes only. Unless otherwise specified V<sub>IN</sub> = 5V and I<sub>LOAD</sub> = 0A.

Symbol	Parameter	Conditions	Min <sup>(1)</sup>	Typ <sup>(2)</sup>	Max <sup>(1)</sup>	Unit
V <sub>REF</sub>	Output Voltage Initial Accuracy					
	LM4128A-2.5	(A Grade - 0.1%)	-0.1		+0.1	%
	LM4128B-2.5	(B Grade - 0.2%)	-0.2		+0.2	
	LM4128C-2.5	(C Grade - 0.5%)	-0.5		+0.5	
LM4128D-2.5	(D Grade - 1.0%)	-1.0		+1.0		
TCV <sub>REF</sub> / °C <sup>(3)</sup>	Temperature Coefficient	LM4128A-2.5			<b>75</b>	ppm / °C
		LM4128B-2.5			<b>75</b>	
		LM4128C-2.5			<b>100</b>	
		LM4128D-2.5			<b>100</b>	
I <sub>Q</sub>	Supply Current			60	<b>100</b>	μA
I <sub>Q_SD</sub>	Supply Current in Shutdown	EN = 0V		3	<b>7</b>	μA
ΔV <sub>REF</sub> /ΔV <sub>IN</sub>	Line Regulation	V <sub>REF</sub> + 400 mV ≤ V <sub>IN</sub> ≤ 5.5V		50		ppm / V
ΔV <sub>REF</sub> /ΔI <sub>LOAD</sub>	Load Regulation	0 mA ≤ I <sub>LOAD</sub> ≤ 20 mA		25	<b>120</b>	ppm / mA
ΔV <sub>REF</sub>	Long Term Stability <sup>(4)</sup>	1000 Hrs		50		ppm
	Thermal Hysteresis <sup>(5)</sup>	-40°C ≤ T <sub>J</sub> ≤ +125°C		75		
V <sub>IN</sub> - V <sub>REF</sub>	Dropout Voltage <sup>(6)</sup>	I <sub>LOAD</sub> = 10 mA		175	<b>400</b>	mV
V <sub>N</sub>	Output Noise Voltage	0.1 Hz to 10 Hz		275		μV <sub>PP</sub>
I <sub>SC</sub>	Short Circuit Current				<b>75</b>	mA
V <sub>IL</sub>	Enable Pin Maximum Low Input Level				<b>35</b>	%V
V <sub>IH</sub>	Enable Pin Minimum High Input Level		<b>65</b>			%V

(1) Limits are 100% production tested at 25°C. Limits over the operating temperature range are ensured through correlation using Statistical Quality Control.

(2) Typical numbers are at 25°C and represent the most likely parametric norm.

(3) Temperature coefficient is measured by the "Box" method; i.e., the maximum ΔV<sub>REF</sub> is divided by the maximum ΔT.

(4) Long term stability is V<sub>REF</sub> @25°C measured during 1000 hrs.

(5) Thermal hysteresis is defined as the change in +25°C output voltage before and after cycling the device from (-40°C to 125°C).

(6) Dropout voltage is defined as the minimum input to output differential at which the output voltage drops by 0.5% below the value measured with a 5V input.

## Electrical Characteristics

### LM4128-3.0 (V<sub>OUT</sub> = 3.0V)

Limits in standard type are for T<sub>J</sub> = 25°C only, and limits in **boldface type** apply over the junction temperature (T<sub>J</sub>) range of -40°C to +125°C unless otherwise specified. Minimum and Maximum limits are ensured through test, design, or statistical correlation. Typical values represent the most likely parametric norm at T<sub>J</sub> = 25°C, and are provided for reference purposes only. Unless otherwise specified V<sub>IN</sub> = 5V and I<sub>LOAD</sub> = 0A.

Symbol	Parameter	Conditions	Min <sup>(1)</sup>	Typ <sup>(2)</sup>	Max <sup>(1)</sup>	Unit
V <sub>REF</sub>	Output Voltage Initial Accuracy					
	LM4128A-3.0	(A Grade - 0.1%)	-0.1		+0.1	%
	LM4128B-3.0	(B Grade - 0.2%)	-0.2		+0.2	
	LM4128C-3.0	(C Grade - 0.5%)	-0.5		+0.5	
LM4128D-3.0	(D Grade - 1.0%)	-1.0		+1.0		
TCV <sub>REF</sub> / °C <sup>(3)</sup>	Temperature Coefficient	LM4128A-3.0			<b>75</b>	ppm / °C
		LM4128B-3.0			<b>75</b>	
		LM4128C-3.0			<b>100</b>	
		LM4128D-3.0			<b>100</b>	
I <sub>Q</sub>	Supply Current			60	<b>100</b>	μA
I <sub>Q_SD</sub>	Supply Current in Shutdown	EN = 0V		3	<b>7</b>	μA
ΔV <sub>REF</sub> /ΔV <sub>IN</sub>	Line Regulation	V <sub>REF</sub> + 400 mV ≤ V <sub>IN</sub> ≤ 5.5V		70		ppm / V
ΔV <sub>REF</sub> /ΔI <sub>LOAD</sub>	Load Regulation	0 mA ≤ I <sub>LOAD</sub> ≤ 20 mA		25	<b>120</b>	ppm / mA
ΔV <sub>REF</sub>	Long Term Stability <sup>(4)</sup>	1000 Hrs		50		ppm
	Thermal Hysteresis <sup>(5)</sup>	-40°C ≤ T <sub>J</sub> ≤ +125°C		75		
V <sub>IN</sub> - V <sub>REF</sub>	Dropout Voltage <sup>(6)</sup>	I <sub>LOAD</sub> = 10 mA		175	<b>400</b>	mV
V <sub>N</sub>	Output Noise Voltage	0.1 Hz to 10 Hz		285		μV <sub>PP</sub>
I <sub>SC</sub>	Short Circuit Current				<b>75</b>	mA
V <sub>IL</sub>	Enable Pin Maximum Low Input Level				<b>35</b>	%V
V <sub>IH</sub>	Enable Pin Minimum High Input Level		<b>65</b>			%V

- (1) Limits are 100% production tested at 25°C. Limits over the operating temperature range are ensured through correlation using Statistical Quality Control.
- (2) Typical numbers are at 25°C and represent the most likely parametric norm.
- (3) Temperature coefficient is measured by the "Box" method; i.e., the maximum ΔV<sub>REF</sub> is divided by the maximum ΔT.
- (4) Long term stability is V<sub>REF</sub> @25°C measured during 1000 hrs.
- (5) Thermal hysteresis is defined as the change in +25°C output voltage before and after cycling the device from (-40°C to 125°C).
- (6) Dropout voltage is defined as the minimum input to output differential at which the output voltage drops by 0.5% below the value measured with a 5V input.

## Electrical Characteristics

### LM4128-3.3 (V<sub>OUT</sub> = 3.3V)

Limits in standard type are for T<sub>J</sub> = 25°C only, and limits in **boldface type** apply over the junction temperature (T<sub>J</sub>) range of -40°C to +125°C unless otherwise specified. Minimum and Maximum limits are ensured through test, design, or statistical correlation. Typical values represent the most likely parametric norm at T<sub>J</sub> = 25°C, and are provided for reference purposes only. Unless otherwise specified V<sub>IN</sub> = 5V and I<sub>LOAD</sub> = 0A.

Symbol	Parameter	Conditions	Min <sup>(1)</sup>	Typ <sup>(2)</sup>	Max <sup>(1)</sup>	Unit	
V <sub>REF</sub>	Output Voltage Initial Accuracy						
	LM4128A-3.3	(A Grade - 0.1%)	-0.1		+0.1	%	
	LM4128B-3.3	(B Grade - 0.2%)	-0.2		+0.2		
	LM4128C-3.3	(C Grade - 0.5%)	-0.5		+0.5		
LM4128D-3.3	(D Grade - 1.0%)	-1.0		+1.0			
TCV <sub>REF</sub> / °C <sup>(3)</sup>	Temperature Coefficient	LM4128A-3.3			<b>75</b>	ppm / °C	
		LM4128B-3.3			<b>75</b>		
		LM4128C-3.3			<b>100</b>		
		LM4128D-3.3			<b>100</b>		
I <sub>Q</sub>	Supply Current		60	<b>100</b>		μA	
I <sub>Q_SD</sub>	Supply Current in Shutdown	EN = 0V		3	<b>7</b>		μA
ΔV <sub>REF</sub> /ΔV <sub>IN</sub>	Line Regulation	V <sub>REF</sub> + 400 mV ≤ V <sub>IN</sub> ≤ 5.5V		85			ppm / V
ΔV <sub>REF</sub> /ΔI <sub>LOAD</sub>	Load Regulation	0 mA ≤ I <sub>LOAD</sub> ≤ 20 mA		25	<b>120</b>		ppm / mA
ΔV <sub>REF</sub>	Long Term Stability <sup>(4)</sup>	1000 Hrs		50			ppm
	Thermal Hysteresis <sup>(5)</sup>	-40°C ≤ T <sub>J</sub> ≤ +125°C		75			
V <sub>IN</sub> - V <sub>REF</sub>	Dropout Voltage <sup>(6)</sup>	I <sub>LOAD</sub> = 10 mA		175	<b>400</b>		mV
V <sub>N</sub>	Output Noise Voltage	0.1 Hz to 10 Hz		310			μV <sub>PP</sub>
I <sub>SC</sub>	Short Circuit Current				<b>75</b>		mA
V <sub>IL</sub>	Enable Pin Maximum Low Input Level				<b>35</b>		%V
V <sub>IH</sub>	Enable Pin Minimum High Input Level		<b>65</b>				%V

- (1) Limits are 100% production tested at 25°C. Limits over the operating temperature range are ensured through correlation using Statistical Quality Control.
- (2) Typical numbers are at 25°C and represent the most likely parametric norm.
- (3) Temperature coefficient is measured by the "Box" method; i.e., the maximum ΔV<sub>REF</sub> is divided by the maximum ΔT.
- (4) Long term stability is V<sub>REF</sub> @25°C measured during 1000 hrs.
- (5) Thermal hysteresis is defined as the change in +25°C output voltage before and after cycling the device from (-40°C to 125°C).
- (6) Dropout voltage is defined as the minimum input to output differential at which the output voltage drops by 0.5% below the value measured with a 5V input.

## Electrical Characteristics

### LM4128-4.1 ( $V_{OUT} = 4.096V$ )

Limits in standard type are for  $T_J = 25^\circ C$  only, and limits in **boldface type** apply over the junction temperature ( $T_J$ ) range of -40°C to +125°C unless otherwise specified. Minimum and Maximum limits are ensured through test, design, or statistical correlation. Typical values represent the most likely parametric norm at  $T_J = 25^\circ C$ , and are provided for reference purposes only. Unless otherwise specified  $V_{IN} = 5V$  and  $I_{LOAD} = 0A$ .

Symbol	Parameter	Conditions	Min <sup>(1)</sup>	Typ <sup>(2)</sup>	Max <sup>(1)</sup>	Unit
$V_{REF}$	Output Voltage Initial Accuracy					
	LM4128A-4.1	(A Grade - 0.1%)	-0.1		+0.1	%
	LM4128B-4.1	(B Grade - 0.2%)	-0.2		+0.2	
	LM4128C-4.1	(C Grade - 0.5%)	-0.5		+0.5	
LM4128D-4.1	(D Grade - 1.0%)	-1.0		+1.0		
$TCV_{REF} / ^\circ C^{(3)}$	Temperature Coefficient	LM4128A-4.1			<b>75</b>	ppm / °C
		LM4128B-4.1			<b>75</b>	
		LM4128C-4.1			<b>100</b>	
		LM4128D-4.1			<b>100</b>	
$I_Q$	Supply Current			60	<b>100</b>	$\mu A$
$I_{Q\_SD}$	Supply Current in Shutdown	EN = 0V		3	<b>7</b>	$\mu A$
$\Delta V_{REF}/\Delta V_{IN}$	Line Regulation	$V_{REF} + 400\text{ mV} \leq V_{IN} \leq 5.5V$		100		ppm / V
$\Delta V_{REF}/\Delta I_{LOAD}$	Load Regulation	$0\text{ mA} \leq I_{LOAD} \leq 20\text{ mA}$		25	<b>120</b>	ppm / mA
$\Delta V_{REF}$	Long Term Stability <sup>(4)</sup>	1000 Hrs		50		ppm
	Thermal Hysteresis <sup>(5)</sup>	$-40^\circ C \leq T_J \leq +125^\circ C$		75		
$V_{IN} - V_{REF}$	Dropout Voltage <sup>(6)</sup>	$I_{LOAD} = 10\text{ mA}$		175	<b>400</b>	mV
$V_N$	Output Noise Voltage	0.1 Hz to 10 Hz		350		$\mu V_{PP}$
$I_{SC}$	Short Circuit Current				<b>75</b>	mA
$V_{IL}$	Enable Pin Maximum Low Input Level				<b>35</b>	%V
$V_{IH}$	Enable Pin Minimum High Input Level		<b>65</b>			%V

- (1) Limits are 100% production tested at 25°C. Limits over the operating temperature range are ensured through correlation using Statistical Quality Control.
- (2) Typical numbers are at 25°C and represent the most likely parametric norm.
- (3) Temperature coefficient is measured by the "Box" method; i.e., the maximum  $\Delta V_{REF}$  is divided by the maximum  $\Delta T$ .
- (4) Long term stability is  $V_{REF}$  @25°C measured during 1000 hrs.
- (5) Thermal hysteresis is defined as the change in +25°C output voltage before and after cycling the device from (-40°C to 125°C).
- (6) Dropout voltage is defined as the minimum input to output differential at which the output voltage drops by 0.5% below the value measured with a 5V input.

Typical Performance Characteristics for 2.5V



Figure 1.



Figure 2.

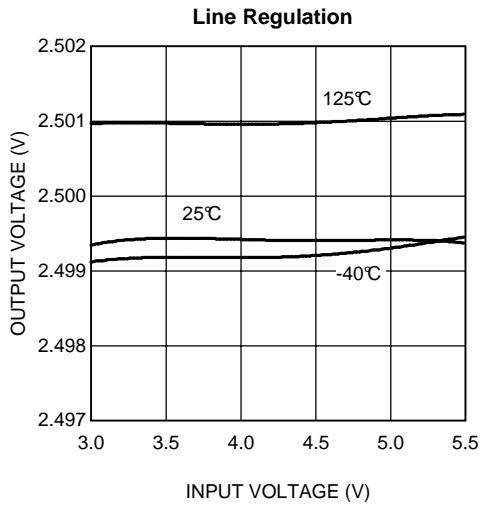

Figure 3.



Figure 4.



Figure 5.



Figure 6.

**Typical Performance Characteristics for 2.5V (continued)**



Figure 7.



Figure 8.



Figure 9.

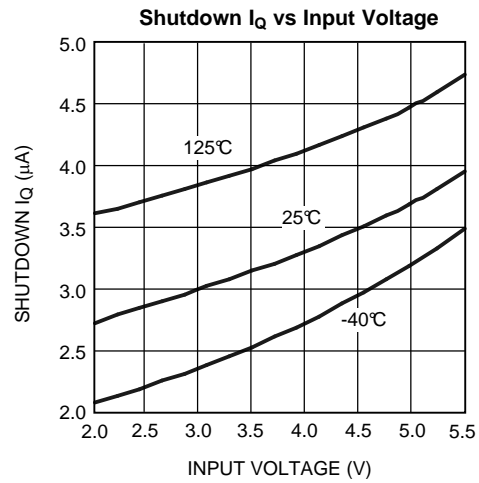

Figure 10.

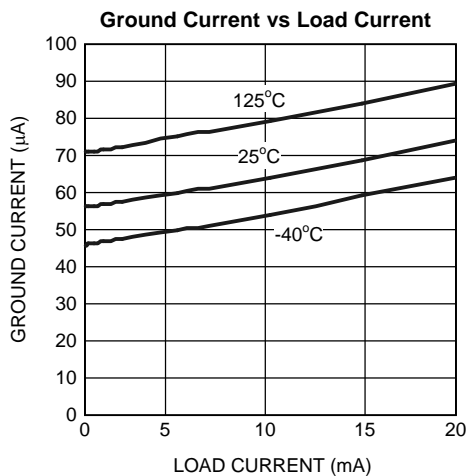

Figure 11.

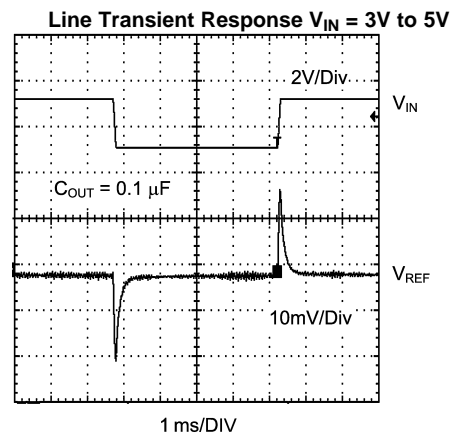

Figure 12.

Typical Performance Characteristics for 2.5V (continued)

Load Transient Response  $I_{LOAD} = 0$  to 10mA

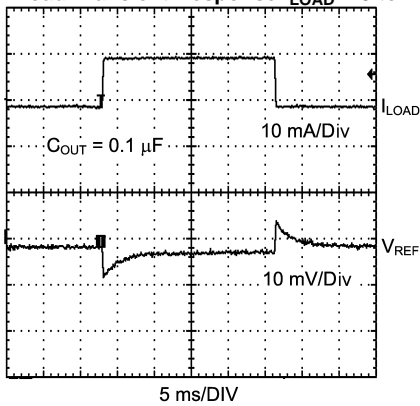

Figure 13.

Short-Circuit Protection and Recovery



Figure 14.

Start-Up Response

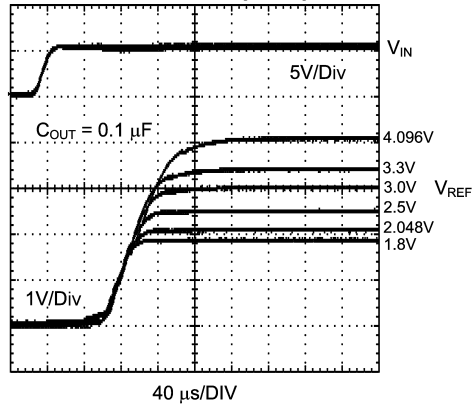

Figure 15.

## APPLICATION INFORMATION

### THEORY OF OPERATION

The foundation of any voltage reference is the band-gap circuit. While the reference in the LM4128 is developed from the gate-source voltage of transistors in the IC, principles of the band-gap circuit are easily understood using a bipolar example. For a detailed analysis of the bipolar band-gap circuit, see the AN-56 Application Report ([SNVA514](#)).

### SUPPLY AND ENABLE VOLTAGES

To ensure proper operation,  $V_{EN}$  and  $V_{IN}$  must be within a specified range. An acceptable range of input voltages is

$$V_{IN} > V_{REF} + 400 \text{ mV} \quad (I_{LOAD} \leq 10 \text{ mA}) \quad (1)$$

The enable pin uses an internal pull-up current source ( $I_{PULL\_UP} \approx 2 \mu\text{A}$ ) that may be left floating or triggered by an external source. If the part is not enabled by an external source, it may be connected to  $V_{IN}$ . An acceptable range of enable voltages is given by the enable transfer characteristics. See the [Electrical Characteristics](#) section and Enable Transfer Characteristics figure for more detail. Note, the part will not operate correctly for  $V_{EN} > V_{IN}$ .

### COMPONENT SELECTION

A small ceramic (X5R or X7R) capacitor on the input must be used to ensure stable operation. The value of  $C_{IN}$  must be sized according to the output capacitor value. The value of  $C_{IN}$  must satisfy the relationship  $C_{IN} \geq C_{OUT}$ . When no output capacitor is used,  $C_{IN}$  must have a minimum value of 0.1  $\mu\text{F}$ . Noise on the power-supply input may affect the output noise. Larger input capacitor values (typically 4.7  $\mu\text{F}$  to 22  $\mu\text{F}$ ) may help reduce noise on the output and significantly reduce overshoot during startup. Use of an additional optional bypass capacitor between the input and ground may help further reduce noise on the output. With an input capacitor, the LM4128 will drive any combination of resistance and capacitance up to  $V_{REF}/20 \text{ mA}$  and 10  $\mu\text{F}$  respectively.

The LM4128 is designed to operate with or without an output capacitor and is stable with capacitive loads up to 10  $\mu\text{F}$ . Connecting a capacitor between the output and ground will significantly improve the load transient response when switching from a light load to a heavy load. The output capacitor should not be made arbitrarily large because it will effect the turn-on time as well as line and load transients.

While a variety of capacitor chemistry types may be used, it is typically advisable to use low esr ceramic capacitors. Such capacitors provide a low impedance to high frequency signals, effectively bypassing them to ground. Bypass capacitors should be mounted close to the part. Mounting bypass capacitors close to the part will help reduce the parasitic trace components thereby improving performance.

### SHORT CIRCUITED OUTPUT

The LM4128 features indefinite short circuit protection. This protection limits the output current to 75 mA when the output is shorted to ground.

### TURN ON TIME

Turn on time is defined as the time taken for the output voltage to rise to 90% of the preset value. The turn on time depends on the load. The turn on time is typically 33.2  $\mu\text{s}$  when driving a 1  $\mu\text{F}$  load and 78.8  $\mu\text{s}$  when driving a 10  $\mu\text{F}$  load. Some users may experience an extended turn on time (up to 10 ms) under brown out conditions and low temperatures (-40°C).

### THERMAL HYSTERESIS

Thermal hysteresis is defined as the change in output voltage at 25°C after some deviation from 25°C. This is to say that thermal hysteresis is the difference in output voltage between two points in a given temperature profile. An illustrative temperature profile is shown in [Figure 16](#).



Figure 16. Illustrative Temperature Profile

This may be expressed analytically as the following:

$$V_{HYS} = \frac{|V_{REF1} - V_{REF2}|}{V_{REF}} \times 10^3 \text{ mV}$$

where

- $V_{HYS}$  = Thermal hysteresis expressed in ppm
- $V_{REF}$  = Nominal preset output voltage
- $V_{REF1} = V_{REF}$  before temperature fluctuation
- $V_{REF2} = V_{REF}$  after temperature fluctuation

(2)

The LM4128 features a low thermal hysteresis of 190  $\mu\text{V}$  from  $-40^\circ\text{C}$  to  $125^\circ\text{C}$ .

### TEMPERATURE COEFFICIENT

Temperature drift is defined as the maximum deviation in output voltage over the operating temperature range. This deviation over temperature may be illustrated as shown in Figure 17.

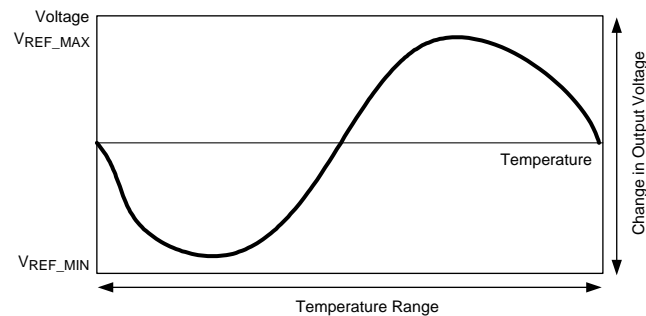

Figure 17. Illustrative Temperature Coefficient Profile

Temperature coefficient may be expressed analytically as the following:

$$T_D = \frac{(V_{REF\_MAX} - V_{REF\_MIN})}{V_{REF} \times \Delta T} \times 10^6 \text{ ppm}$$

where

- $T_D$  = Temperature drift
  - $V_{REF}$  = Nominal preset output voltage
  - $V_{REF\_MIN}$  = Minimum output voltage over operating temperature range
  - $V_{REF\_MAX}$  = Maximum output voltage over operating temperature range
  - $\Delta T$  = Operating temperature range
- (3)

The LM4128 features a low temperature drift of 75 ppm (max) to 100 ppm (max), depending on the grade, from -40°C to 125°C.

## LONG TERM STABILITY

Long-term stability refers to the fluctuation in output voltage over a long period of time (1000 hours). The LM4128 features a typical long-term stability of 50 ppm over 1000 hours. The measurements are made using 5 units of each voltage option, at a nominal input voltage (5V), with no load, at room temperature.

## EXPRESSION OF ELECTRICAL CHARACTERISTICS

Electrical characteristics are typically expressed in mV, ppm, or a percentage of the nominal value. Depending on the application, one expression may be more useful than the other. To convert one quantity to the other one may apply the following:

ppm to mV error in output voltage:

$$\frac{V_{REF} \times \text{ppm}_{ERROR}}{10^3} = V_{ERROR}$$

where

- $V_{REF}$  is in volts (V) and  $V_{ERROR}$  is in milli-volts (mV)
- (4)

Bit error (1 bit) to voltage error (mV):

$$\frac{V_{REF}}{2^n} \times 10^3 = V_{ERROR}$$

where

- $V_{REF}$  is in volts (V)
  - $V_{ERROR}$  is in milli-volts (mV)
  - and n is the number of bits
- (5)

mV to ppm error in output voltage:

$$\frac{V_{ERROR}}{V_{REF}} \times 10^3 = \text{ppm}_{ERROR}$$

where

- $V_{REF}$  is in volts (V)
  - $V_{ERROR}$  is in milli-volts (mV)
- (6)

Voltage error (mV) to percentage error (percent):

$$\frac{V_{ERROR}}{V_{REF}} \times 0.1 = \text{Percent\_Error}$$

where

- $V_{REF}$  is in volts (V)
  - $V_{ERROR}$  is in milli-volts (mV)
- (7)



### REVISION HISTORY

Changes from Revision D (April 2013) to Revision E	Page
• Changed layout of National Data Sheet to TI format .....	<a href="#">15</a>

**PACKAGING INFORMATION**

Orderable Device	Status (1)	Package Type	Package Drawing	Pins	Package Qty	Eco Plan (2)	Lead/Ball Finish (6)	MSL Peak Temp (3)	Op Temp (°C)	Device Marking (4/5)	Samples
LM4128AMF-1.8/NOPB	ACTIVE	SOT-23	DBV	5	1000	Green (RoHS & no Sb/Br)	CU SN	Level-1-260C-UNLIM	-40 to 125	R5AA	<a href="#">Samples</a>
LM4128AMF-2.0/NOPB	ACTIVE	SOT-23	DBV	5	1000	Green (RoHS & no Sb/Br)	CU SN	Level-1-260C-UNLIM	-40 to 125	R5BA	<a href="#">Samples</a>
LM4128AMF-2.5/NOPB	ACTIVE	SOT-23	DBV	5	1000	Green (RoHS & no Sb/Br)	CU SN	Level-1-260C-UNLIM	-40 to 125	R5CA	<a href="#">Samples</a>
LM4128AMF-3.0/NOPB	ACTIVE	SOT-23	DBV	5	1000	Green (RoHS & no Sb/Br)	CU SN	Level-1-260C-UNLIM	-40 to 125	R5DA	<a href="#">Samples</a>
LM4128AMF-3.3/NOPB	ACTIVE	SOT-23	DBV	5	1000	Green (RoHS & no Sb/Br)	CU SN	Level-1-260C-UNLIM	-40 to 125	R5EA	<a href="#">Samples</a>
LM4128AMF-4.1/NOPB	ACTIVE	SOT-23	DBV	5	1000	Green (RoHS & no Sb/Br)	CU SN	Level-1-260C-UNLIM	-40 to 125	R5FA	<a href="#">Samples</a>
LM4128AMFX-1.8/NOPB	ACTIVE	SOT-23	DBV	5	3000	Green (RoHS & no Sb/Br)	CU SN	Level-1-260C-UNLIM	-40 to 125	R5AA	<a href="#">Samples</a>
LM4128AMFX-2.0/NOPB	ACTIVE	SOT-23	DBV	5	3000	Green (RoHS & no Sb/Br)	CU SN	Level-1-260C-UNLIM	-40 to 125	R5BA	<a href="#">Samples</a>
LM4128AMFX-2.5/NOPB	ACTIVE	SOT-23	DBV	5	3000	Green (RoHS & no Sb/Br)	CU SN	Level-1-260C-UNLIM	-40 to 125	R5CA	<a href="#">Samples</a>
LM4128AMFX-3.0/NOPB	ACTIVE	SOT-23	DBV	5	3000	Green (RoHS & no Sb/Br)	CU SN	Level-1-260C-UNLIM	-40 to 125	R5DA	<a href="#">Samples</a>
LM4128AMFX-3.3/NOPB	ACTIVE	SOT-23	DBV	5	3000	Green (RoHS & no Sb/Br)	CU SN	Level-1-260C-UNLIM	-40 to 125	R5EA	<a href="#">Samples</a>
LM4128AMFX-4.1/NOPB	ACTIVE	SOT-23	DBV	5	3000	Green (RoHS & no Sb/Br)	CU SN	Level-1-260C-UNLIM	-40 to 125	R5FA	<a href="#">Samples</a>
LM4128AQ1MF1.8/NOPB	ACTIVE	SOT-23	DBV	5	1000	Green (RoHS & no Sb/Br)	CU SN	Level-1-260C-UNLIM	-40 to 125	R6AA	<a href="#">Samples</a>
LM4128AQ1MF2.0/NOPB	ACTIVE	SOT-23	DBV	5	1000	Green (RoHS & no Sb/Br)	CU SN	Level-1-260C-UNLIM	-40 to 125	R6BA	<a href="#">Samples</a>
LM4128AQ1MF2.5/NOPB	ACTIVE	SOT-23	DBV	5	1000	Green (RoHS & no Sb/Br)	CU SN	Level-1-260C-UNLIM	-40 to 125	R6CA	<a href="#">Samples</a>
LM4128AQ1MF3.0/NOPB	ACTIVE	SOT-23	DBV	5	1000	Green (RoHS & no Sb/Br)	CU SN	Level-1-260C-UNLIM	-40 to 125	R6DA	<a href="#">Samples</a>
LM4128AQ1MF3.3/NOPB	ACTIVE	SOT-23	DBV	5	1000	Green (RoHS & no Sb/Br)	CU SN	Level-1-260C-UNLIM	-40 to 125	R6EA	<a href="#">Samples</a>

Orderable Device	Status (1)	Package Type	Package Drawing	Pins	Package Qty	Eco Plan (2)	Lead/Ball Finish (6)	MSL Peak Temp (3)	Op Temp (°C)	Device Marking (4/5)	Samples
LM4128AQ1MF4.1/NOPB	ACTIVE	SOT-23	DBV	5	1000	Green (RoHS & no Sb/Br)	CU SN	Level-1-260C-UNLIM	-40 to 125	R6FA	<a href="#">Samples</a>
LM4128AQ1MFX1.8/NOPB	ACTIVE	SOT-23	DBV	5	3000	Green (RoHS & no Sb/Br)	CU SN	Level-1-260C-UNLIM	-40 to 125	R6AA	<a href="#">Samples</a>
LM4128AQ1MFX2.0/NOPB	ACTIVE	SOT-23	DBV	5	3000	Green (RoHS & no Sb/Br)	CU SN	Level-1-260C-UNLIM	-40 to 125	R6BA	<a href="#">Samples</a>
LM4128AQ1MFX2.5/NOPB	ACTIVE	SOT-23	DBV	5	3000	Green (RoHS & no Sb/Br)	CU SN	Level-1-260C-UNLIM	-40 to 125	R6CA	<a href="#">Samples</a>
LM4128AQ1MFX3.0/NOPB	ACTIVE	SOT-23	DBV	5	3000	Green (RoHS & no Sb/Br)	CU SN	Level-1-260C-UNLIM	-40 to 125	R6DA	<a href="#">Samples</a>
LM4128AQ1MFX3.3/NOPB	ACTIVE	SOT-23	DBV	5	3000	Green (RoHS & no Sb/Br)	CU SN	Level-1-260C-UNLIM	-40 to 125	R6EA	<a href="#">Samples</a>
LM4128AQ1MFX4.1/NOPB	ACTIVE	SOT-23	DBV	5	3000	Green (RoHS & no Sb/Br)	CU SN	Level-1-260C-UNLIM	-40 to 125	R6FA	<a href="#">Samples</a>
LM4128BMF-1.8/NOPB	ACTIVE	SOT-23	DBV	5	1000	Green (RoHS & no Sb/Br)	CU SN	Level-1-260C-UNLIM	-40 to 125	R5AB	<a href="#">Samples</a>
LM4128BMF-2.0/NOPB	ACTIVE	SOT-23	DBV	5	1000	Green (RoHS & no Sb/Br)	CU SN	Level-1-260C-UNLIM	-40 to 125	R5BB	<a href="#">Samples</a>
LM4128BMF-2.5	NRND	SOT-23	DBV	5	1000	TBD	Call TI	Call TI	-40 to 125	R5CB	
LM4128BMF-2.5/NOPB	ACTIVE	SOT-23	DBV	5	1000	Green (RoHS & no Sb/Br)	CU SN	Level-1-260C-UNLIM	-40 to 125	R5CB	<a href="#">Samples</a>
LM4128BMF-3.0/NOPB	ACTIVE	SOT-23	DBV	5	1000	Green (RoHS & no Sb/Br)	CU SN	Level-1-260C-UNLIM	-40 to 125	R5DB	<a href="#">Samples</a>
LM4128BMF-3.3/NOPB	ACTIVE	SOT-23	DBV	5	1000	Green (RoHS & no Sb/Br)	CU SN	Level-1-260C-UNLIM	-40 to 125	R5EB	<a href="#">Samples</a>
LM4128BMF-4.1/NOPB	ACTIVE	SOT-23	DBV	5	1000	Green (RoHS & no Sb/Br)	CU SN	Level-1-260C-UNLIM	-40 to 125	R5FB	<a href="#">Samples</a>
LM4128BMFX-1.8/NOPB	ACTIVE	SOT-23	DBV	5	3000	Green (RoHS & no Sb/Br)	CU SN	Level-1-260C-UNLIM	-40 to 125	R5AB	<a href="#">Samples</a>
LM4128BMFX-2.0/NOPB	ACTIVE	SOT-23	DBV	5	3000	Green (RoHS & no Sb/Br)	CU SN	Level-1-260C-UNLIM	-40 to 125	R5BB	<a href="#">Samples</a>
LM4128BMFX-2.5/NOPB	ACTIVE	SOT-23	DBV	5	3000	Green (RoHS & no Sb/Br)	CU SN	Level-1-260C-UNLIM	-40 to 125	R5CB	<a href="#">Samples</a>
LM4128BMFX-3.0/NOPB	ACTIVE	SOT-23	DBV	5	3000	Green (RoHS & no Sb/Br)	CU SN	Level-1-260C-UNLIM	-40 to 125	R5DB	<a href="#">Samples</a>

Orderable Device	Status (1)	Package Type	Package Drawing	Pins	Package Qty	Eco Plan (2)	Lead/Ball Finish (6)	MSL Peak Temp (3)	Op Temp (°C)	Device Marking (4/5)	Samples
LM4128BMFX-3.3/NOPB	ACTIVE	SOT-23	DBV	5	3000	Green (RoHS & no Sb/Br)	CU SN	Level-1-260C-UNLIM	-40 to 125	R5EB	<a href="#">Samples</a>
LM4128BMFX-4.1/NOPB	ACTIVE	SOT-23	DBV	5	3000	Green (RoHS & no Sb/Br)	CU SN	Level-1-260C-UNLIM	-40 to 125	R5FB	<a href="#">Samples</a>
LM4128BQ1MF1.8/NOPB	ACTIVE	SOT-23	DBV	5	1000	Green (RoHS & no Sb/Br)	CU SN	Level-1-260C-UNLIM	-40 to 125	R6AB	<a href="#">Samples</a>
LM4128BQ1MF2.0/NOPB	ACTIVE	SOT-23	DBV	5	1000	Green (RoHS & no Sb/Br)	CU SN	Level-1-260C-UNLIM	-40 to 125	R6BB	<a href="#">Samples</a>
LM4128BQ1MF2.5/NOPB	ACTIVE	SOT-23	DBV	5	1000	Green (RoHS & no Sb/Br)	CU SN	Level-1-260C-UNLIM	-40 to 125	R6CB	<a href="#">Samples</a>
LM4128BQ1MF3.0/NOPB	ACTIVE	SOT-23	DBV	5	1000	Green (RoHS & no Sb/Br)	CU SN	Level-1-260C-UNLIM	-40 to 125	R6DB	<a href="#">Samples</a>
LM4128BQ1MF3.3/NOPB	ACTIVE	SOT-23	DBV	5	1000	Green (RoHS & no Sb/Br)	CU SN	Level-1-260C-UNLIM	-40 to 125	R6EB	<a href="#">Samples</a>
LM4128BQ1MF4.1/NOPB	ACTIVE	SOT-23	DBV	5	1000	Green (RoHS & no Sb/Br)	CU SN	Level-1-260C-UNLIM	-40 to 125	R6FB	<a href="#">Samples</a>
LM4128BQ1MFX1.8/NOPB	ACTIVE	SOT-23	DBV	5	3000	Green (RoHS & no Sb/Br)	CU SN	Level-1-260C-UNLIM	-40 to 125	R6AB	<a href="#">Samples</a>
LM4128BQ1MFX2.0/NOPB	ACTIVE	SOT-23	DBV	5	3000	Green (RoHS & no Sb/Br)	CU SN	Level-1-260C-UNLIM	-40 to 125	R6BB	<a href="#">Samples</a>
LM4128BQ1MFX2.5/NOPB	ACTIVE	SOT-23	DBV	5	3000	Green (RoHS & no Sb/Br)	CU SN	Level-1-260C-UNLIM	-40 to 125	R6CB	<a href="#">Samples</a>
LM4128BQ1MFX3.0/NOPB	ACTIVE	SOT-23	DBV	5	3000	Green (RoHS & no Sb/Br)	CU SN	Level-1-260C-UNLIM	-40 to 125	R6DB	<a href="#">Samples</a>
LM4128BQ1MFX3.3/NOPB	ACTIVE	SOT-23	DBV	5	3000	Green (RoHS & no Sb/Br)	CU SN	Level-1-260C-UNLIM	-40 to 125	R6EB	<a href="#">Samples</a>
LM4128BQ1MFX4.1/NOPB	ACTIVE	SOT-23	DBV	5	3000	Green (RoHS & no Sb/Br)	CU SN	Level-1-260C-UNLIM	-40 to 125	R6FB	<a href="#">Samples</a>
LM4128CMF-1.8/NOPB	ACTIVE	SOT-23	DBV	5	1000	Green (RoHS & no Sb/Br)	CU SN	Level-1-260C-UNLIM	-40 to 125	R5AC	<a href="#">Samples</a>
LM4128CMF-2.0/NOPB	ACTIVE	SOT-23	DBV	5	1000	Green (RoHS & no Sb/Br)	CU SN	Level-1-260C-UNLIM	-40 to 125	R5BC	<a href="#">Samples</a>
LM4128CMF-2.5/NOPB	ACTIVE	SOT-23	DBV	5	1000	Green (RoHS & no Sb/Br)	CU SN	Level-1-260C-UNLIM	-40 to 125	R5CC	<a href="#">Samples</a>
LM4128CMF-3.0/NOPB	ACTIVE	SOT-23	DBV	5	1000	Green (RoHS & no Sb/Br)	CU SN	Level-1-260C-UNLIM	-40 to 125	R5DC	<a href="#">Samples</a>

Orderable Device	Status (1)	Package Type	Package Drawing	Pins	Package Qty	Eco Plan (2)	Lead/Ball Finish (6)	MSL Peak Temp (3)	Op Temp (°C)	Device Marking (4/5)	Samples
LM4128CMF-3.3/NOPB	ACTIVE	SOT-23	DBV	5	1000	Green (RoHS & no Sb/Br)	CU SN	Level-1-260C-UNLIM	-40 to 125	R5EC	<a href="#">Samples</a>
LM4128CMF-4.1/NOPB	ACTIVE	SOT-23	DBV	5	1000	Green (RoHS & no Sb/Br)	CU SN	Level-1-260C-UNLIM	-40 to 125	R5FC	<a href="#">Samples</a>
LM4128CMFX-1.8/NOPB	ACTIVE	SOT-23	DBV	5	3000	Green (RoHS & no Sb/Br)	CU SN	Level-1-260C-UNLIM	-40 to 125	R5AC	<a href="#">Samples</a>
LM4128CMFX-2.0/NOPB	ACTIVE	SOT-23	DBV	5	3000	Green (RoHS & no Sb/Br)	CU SN	Level-1-260C-UNLIM	-40 to 125	R5BC	<a href="#">Samples</a>
LM4128CMFX-2.5/NOPB	ACTIVE	SOT-23	DBV	5	3000	Green (RoHS & no Sb/Br)	CU SN	Level-1-260C-UNLIM	-40 to 125	R5CC	<a href="#">Samples</a>
LM4128CMFX-3.0/NOPB	ACTIVE	SOT-23	DBV	5	3000	Green (RoHS & no Sb/Br)	CU SN	Level-1-260C-UNLIM	-40 to 125	R5DC	<a href="#">Samples</a>
LM4128CMFX-3.3/NOPB	ACTIVE	SOT-23	DBV	5	3000	Green (RoHS & no Sb/Br)	CU SN	Level-1-260C-UNLIM	-40 to 125	R5EC	<a href="#">Samples</a>
LM4128CMFX-4.1/NOPB	ACTIVE	SOT-23	DBV	5	3000	Green (RoHS & no Sb/Br)	CU SN	Level-1-260C-UNLIM	-40 to 125	R5FC	<a href="#">Samples</a>
LM4128CQ1MF1.8/NOPB	ACTIVE	SOT-23	DBV	5	1000	Green (RoHS & no Sb/Br)	CU SN	Level-1-260C-UNLIM	-40 to 125	R6AC	<a href="#">Samples</a>
LM4128CQ1MF2.0/NOPB	ACTIVE	SOT-23	DBV	5	1000	Green (RoHS & no Sb/Br)	CU SN	Level-1-260C-UNLIM	-40 to 125	R6BC	<a href="#">Samples</a>
LM4128CQ1MF2.5/NOPB	ACTIVE	SOT-23	DBV	5	1000	Green (RoHS & no Sb/Br)	CU SN	Level-1-260C-UNLIM	-40 to 125	R6CC	<a href="#">Samples</a>
LM4128CQ1MF3.0/NOPB	ACTIVE	SOT-23	DBV	5	1000	Green (RoHS & no Sb/Br)	CU SN	Level-1-260C-UNLIM	-40 to 125	R6DC	<a href="#">Samples</a>
LM4128CQ1MF3.3/NOPB	ACTIVE	SOT-23	DBV	5	1000	Green (RoHS & no Sb/Br)	CU SN	Level-1-260C-UNLIM	-40 to 125	R6EC	<a href="#">Samples</a>
LM4128CQ1MF4.1/NOPB	ACTIVE	SOT-23	DBV	5	1000	Green (RoHS & no Sb/Br)	CU SN	Level-1-260C-UNLIM	-40 to 125	R6FC	<a href="#">Samples</a>
LM4128CQ1MF1.8/NOPB	ACTIVE	SOT-23	DBV	5	3000	Green (RoHS & no Sb/Br)	CU SN	Level-1-260C-UNLIM	-40 to 125	R6AC	<a href="#">Samples</a>
LM4128CQ1MF2.0/NOPB	ACTIVE	SOT-23	DBV	5	3000	Green (RoHS & no Sb/Br)	CU SN	Level-1-260C-UNLIM	-40 to 125	R6BC	<a href="#">Samples</a>
LM4128CQ1MF2.5/NOPB	ACTIVE	SOT-23	DBV	5	3000	Green (RoHS & no Sb/Br)	CU SN	Level-1-260C-UNLIM	-40 to 125	R6CC	<a href="#">Samples</a>
LM4128CQ1MF3.0/NOPB	ACTIVE	SOT-23	DBV	5	3000	Green (RoHS & no Sb/Br)	CU SN	Level-1-260C-UNLIM	-40 to 125	R6DC	<a href="#">Samples</a>

Orderable Device	Status (1)	Package Type	Package Drawing	Pins	Package Qty	Eco Plan (2)	Lead/Ball Finish (6)	MSL Peak Temp (3)	Op Temp (°C)	Device Marking (4/5)	Samples
LM4128CQ1MFX3.3/NOPB	ACTIVE	SOT-23	DBV	5	3000	Green (RoHS & no Sb/Br)	CU SN	Level-1-260C-UNLIM	-40 to 125	R6EC	<a href="#">Samples</a>
LM4128CQ1MFX4.1/NOPB	ACTIVE	SOT-23	DBV	5	3000	Green (RoHS & no Sb/Br)	CU SN	Level-1-260C-UNLIM	-40 to 125	R6FC	<a href="#">Samples</a>
LM4128DMF-1.8/NOPB	ACTIVE	SOT-23	DBV	5	1000	Green (RoHS & no Sb/Br)	CU SN	Level-1-260C-UNLIM	-40 to 125	R5AD	<a href="#">Samples</a>
LM4128DMF-2.0/NOPB	ACTIVE	SOT-23	DBV	5	1000	Green (RoHS & no Sb/Br)	CU SN	Level-1-260C-UNLIM	-40 to 125	R5BD	<a href="#">Samples</a>
LM4128DMF-2.5/NOPB	ACTIVE	SOT-23	DBV	5	1000	Green (RoHS & no Sb/Br)	CU SN	Level-1-260C-UNLIM	-40 to 125	R5CD	<a href="#">Samples</a>
LM4128DMF-3.0/NOPB	ACTIVE	SOT-23	DBV	5	1000	Green (RoHS & no Sb/Br)	CU SN	Level-1-260C-UNLIM	-40 to 125	R5DD	<a href="#">Samples</a>
LM4128DMF-3.3/NOPB	ACTIVE	SOT-23	DBV	5	1000	Green (RoHS & no Sb/Br)	CU SN	Level-1-260C-UNLIM	-40 to 125	R5ED	<a href="#">Samples</a>
LM4128DMF-4.1/NOPB	ACTIVE	SOT-23	DBV	5	1000	Green (RoHS & no Sb/Br)	CU SN	Level-1-260C-UNLIM	-40 to 125	R5FD	<a href="#">Samples</a>
LM4128DMFX-1.8/NOPB	ACTIVE	SOT-23	DBV	5	3000	Green (RoHS & no Sb/Br)	CU SN	Level-1-260C-UNLIM	-40 to 125	R5AD	<a href="#">Samples</a>
LM4128DMFX-2.0/NOPB	ACTIVE	SOT-23	DBV	5	3000	Green (RoHS & no Sb/Br)	CU SN	Level-1-260C-UNLIM	-40 to 125	R5BD	<a href="#">Samples</a>
LM4128DMFX-3.0/NOPB	ACTIVE	SOT-23	DBV	5	3000	Green (RoHS & no Sb/Br)	CU SN	Level-1-260C-UNLIM	-40 to 125	R5DD	<a href="#">Samples</a>
LM4128DMFX-3.3/NOPB	ACTIVE	SOT-23	DBV	5	3000	Green (RoHS & no Sb/Br)	CU SN	Level-1-260C-UNLIM	-40 to 125	R5ED	<a href="#">Samples</a>
LM4128DMFX-4.1/NOPB	ACTIVE	SOT-23	DBV	5	3000	Green (RoHS & no Sb/Br)	CU SN	Level-1-260C-UNLIM	-40 to 125	R5FD	<a href="#">Samples</a>
LM4128DQ1MF1.8/NOPB	ACTIVE	SOT-23	DBV	5	1000	Green (RoHS & no Sb/Br)	CU SN	Level-1-260C-UNLIM	-40 to 125	R6AD	<a href="#">Samples</a>
LM4128DQ1MF2.0/NOPB	ACTIVE	SOT-23	DBV	5	1000	Green (RoHS & no Sb/Br)	CU SN	Level-1-260C-UNLIM	-40 to 125	R6BD	<a href="#">Samples</a>
LM4128DQ1MF2.5/NOPB	ACTIVE	SOT-23	DBV	5	1000	Green (RoHS & no Sb/Br)	CU SN	Level-1-260C-UNLIM	-40 to 125	R6CD	<a href="#">Samples</a>
LM4128DQ1MF3.0/NOPB	ACTIVE	SOT-23	DBV	5	1000	Green (RoHS & no Sb/Br)	CU SN	Level-1-260C-UNLIM	-40 to 125	R6DD	<a href="#">Samples</a>
LM4128DQ1MF3.3/NOPB	ACTIVE	SOT-23	DBV	5	1000	Green (RoHS & no Sb/Br)	CU SN	Level-1-260C-UNLIM	-40 to 125	R6ED	<a href="#">Samples</a>

Orderable Device	Status (1)	Package Type	Package Drawing	Pins	Package Qty	Eco Plan (2)	Lead/Ball Finish (6)	MSL Peak Temp (3)	Op Temp (°C)	Device Marking (4/5)	Samples
LM4128DQ1MF4.1/NOPB	ACTIVE	SOT-23	DBV	5	1000	Green (RoHS & no Sb/Br)	CU SN	Level-1-260C-UNLIM	-40 to 125	R6FD	<a href="#">Samples</a>
LM4128DQ1MFX1.8/NOPB	ACTIVE	SOT-23	DBV	5	3000	Green (RoHS & no Sb/Br)	CU SN	Level-1-260C-UNLIM	-40 to 125	R6AD	<a href="#">Samples</a>
LM4128DQ1MFX2.0/NOPB	ACTIVE	SOT-23	DBV	5	3000	Green (RoHS & no Sb/Br)	CU SN	Level-1-260C-UNLIM	-40 to 125	R6BD	<a href="#">Samples</a>
LM4128DQ1MFX2.5/NOPB	ACTIVE	SOT-23	DBV	5	3000	Green (RoHS & no Sb/Br)	CU SN	Level-1-260C-UNLIM	-40 to 125	R6CD	<a href="#">Samples</a>
LM4128DQ1MFX3.0/NOPB	ACTIVE	SOT-23	DBV	5	3000	Green (RoHS & no Sb/Br)	CU SN	Level-1-260C-UNLIM	-40 to 125	R6DD	<a href="#">Samples</a>
LM4128DQ1MFX3.3/NOPB	ACTIVE	SOT-23	DBV	5	3000	Green (RoHS & no Sb/Br)	CU SN	Level-1-260C-UNLIM	-40 to 125	R6ED	<a href="#">Samples</a>
LM4128DQ1MFX4.1/NOPB	ACTIVE	SOT-23	DBV	5	3000	Green (RoHS & no Sb/Br)	CU SN	Level-1-260C-UNLIM	-40 to 125	R6FD	<a href="#">Samples</a>

(1) The marketing status values are defined as follows:

**ACTIVE:** Product device recommended for new designs.

**LIFEBUY:** TI has announced that the device will be discontinued, and a lifetime-buy period is in effect.

**NRND:** Not recommended for new designs. Device is in production to support existing customers, but TI does not recommend using this part in a new design.

**PREVIEW:** Device has been announced but is not in production. Samples may or may not be available.

**OBSOLETE:** TI has discontinued the production of the device.

(2) **RoHS:** TI defines "RoHS" to mean semiconductor products that are compliant with the current EU RoHS requirements for all 10 RoHS substances, including the requirement that RoHS substance do not exceed 0.1% by weight in homogeneous materials. Where designed to be soldered at high temperatures, "RoHS" products are suitable for use in specified lead-free processes. TI may reference these types of products as "Pb-Free".

**RoHS Exempt:** TI defines "RoHS Exempt" to mean products that contain lead but are compliant with EU RoHS pursuant to a specific EU RoHS exemption.

**Green:** TI defines "Green" to mean the content of Chlorine (Cl) and Bromine (Br) based flame retardants meet JS709B low halogen requirements of <=1000ppm threshold. Antimony trioxide based flame retardants must also meet the <=1000ppm threshold requirement.

(3) MSL, Peak Temp. - The Moisture Sensitivity Level rating according to the JEDEC industry standard classifications, and peak solder temperature.

(4) There may be additional marking, which relates to the logo, the lot trace code information, or the environmental category on the device.

(5) Multiple Device Markings will be inside parentheses. Only one Device Marking contained in parentheses and separated by a "~" will appear on a device. If a line is indented then it is a continuation of the previous line and the two combined represent the entire Device Marking for that device.

<sup>(6)</sup> Lead/Ball Finish - Orderable Devices may have multiple material finish options. Finish options are separated by a vertical ruled line. Lead/Ball Finish values may wrap to two lines if the finish value exceeds the maximum column width.

**Important Information and Disclaimer:**The information provided on this page represents TI's knowledge and belief as of the date that it is provided. TI bases its knowledge and belief on information provided by third parties, and makes no representation or warranty as to the accuracy of such information. Efforts are underway to better integrate information from third parties. TI has taken and continues to take reasonable steps to provide representative and accurate information but may not have conducted destructive testing or chemical analysis on incoming materials and chemicals. TI and TI suppliers consider certain information to be proprietary, and thus CAS numbers and other limited information may not be available for release.

In no event shall TI's liability arising out of such information exceed the total purchase price of the TI part(s) at issue in this document sold by TI to Customer on an annual basis.

**OTHER QUALIFIED VERSIONS OF LM4128, LM4128-Q1 :**

- Catalog: [LM4128](#)
- Automotive: [LM4128-Q1](#)

NOTE: Qualified Version Definitions:

- Catalog - TI's standard catalog product
- Automotive - Q100 devices qualified for high-reliability automotive applications targeting zero defects

## TAPE AND REEL INFORMATION



### QUADRANT ASSIGNMENTS FOR PIN 1 ORIENTATION IN TAPE



\*All dimensions are nominal

Device	Package Type	Package Drawing	Pins	SPQ	Reel Diameter (mm)	Reel Width W1 (mm)	A0 (mm)	B0 (mm)	K0 (mm)	P1 (mm)	W (mm)	Pin1 Quadrant
LM4128AMF-1.8/NOPB	SOT-23	DBV	5	1000	178.0	8.4	3.2	3.2	1.4	4.0	8.0	Q3
LM4128AMF-2.0/NOPB	SOT-23	DBV	5	1000	178.0	8.4	3.2	3.2	1.4	4.0	8.0	Q3
LM4128AMF-2.5/NOPB	SOT-23	DBV	5	1000	178.0	8.4	3.2	3.2	1.4	4.0	8.0	Q3
LM4128AMF-3.0/NOPB	SOT-23	DBV	5	1000	178.0	8.4	3.2	3.2	1.4	4.0	8.0	Q3
LM4128AMF-3.3/NOPB	SOT-23	DBV	5	1000	178.0	8.4	3.2	3.2	1.4	4.0	8.0	Q3
LM4128AMF-4.1/NOPB	SOT-23	DBV	5	1000	178.0	8.4	3.2	3.2	1.4	4.0	8.0	Q3
LM4128AMFX-1.8/NOPB	SOT-23	DBV	5	3000	178.0	8.4	3.2	3.2	1.4	4.0	8.0	Q3
LM4128AMFX-2.0/NOPB	SOT-23	DBV	5	3000	178.0	8.4	3.2	3.2	1.4	4.0	8.0	Q3
LM4128AMFX-2.5/NOPB	SOT-23	DBV	5	3000	178.0	8.4	3.2	3.2	1.4	4.0	8.0	Q3
LM4128AMFX-3.0/NOPB	SOT-23	DBV	5	3000	178.0	8.4	3.2	3.2	1.4	4.0	8.0	Q3
LM4128AMFX-3.3/NOPB	SOT-23	DBV	5	3000	178.0	8.4	3.2	3.2	1.4	4.0	8.0	Q3
LM4128AMFX-4.1/NOPB	SOT-23	DBV	5	3000	178.0	8.4	3.2	3.2	1.4	4.0	8.0	Q3
LM4128AQ1MF1.8/NOPB	SOT-23	DBV	5	1000	178.0	8.4	3.2	3.2	1.4	4.0	8.0	Q3
LM4128AQ1MF2.0/NOPB	SOT-23	DBV	5	1000	178.0	8.4	3.2	3.2	1.4	4.0	8.0	Q3
LM4128AQ1MF2.5/NOPB	SOT-23	DBV	5	1000	178.0	8.4	3.2	3.2	1.4	4.0	8.0	Q3
LM4128AQ1MF3.0/NOPB	SOT-23	DBV	5	1000	178.0	8.4	3.2	3.2	1.4	4.0	8.0	Q3
LM4128AQ1MF3.3/NOPB	SOT-23	DBV	5	1000	178.0	8.4	3.2	3.2	1.4	4.0	8.0	Q3
LM4128AQ1MF4.1/NOPB	SOT-23	DBV	5	1000	178.0	8.4	3.2	3.2	1.4	4.0	8.0	Q3

Device	Package Type	Package Drawing	Pins	SPQ	Reel Diameter (mm)	Reel Width W1 (mm)	A0 (mm)	B0 (mm)	K0 (mm)	P1 (mm)	W (mm)	Pin1 Quadrant
LM4128AQ1MFX1.8/NOPB	SOT-23	DBV	5	3000	178.0	8.4	3.2	3.2	1.4	4.0	8.0	Q3
LM4128AQ1MFX2.0/NOPB	SOT-23	DBV	5	3000	178.0	8.4	3.2	3.2	1.4	4.0	8.0	Q3
LM4128AQ1MFX2.5/NOPB	SOT-23	DBV	5	3000	178.0	8.4	3.2	3.2	1.4	4.0	8.0	Q3
LM4128AQ1MFX3.0/NOPB	SOT-23	DBV	5	3000	178.0	8.4	3.2	3.2	1.4	4.0	8.0	Q3
LM4128AQ1MFX3.3/NOPB	SOT-23	DBV	5	3000	178.0	8.4	3.2	3.2	1.4	4.0	8.0	Q3
LM4128AQ1MFX4.1/NOPB	SOT-23	DBV	5	3000	178.0	8.4	3.2	3.2	1.4	4.0	8.0	Q3
LM4128BMF-1.8/NOPB	SOT-23	DBV	5	1000	178.0	8.4	3.2	3.2	1.4	4.0	8.0	Q3
LM4128BMF-2.0/NOPB	SOT-23	DBV	5	1000	178.0	8.4	3.2	3.2	1.4	4.0	8.0	Q3
LM4128BMF-2.5	SOT-23	DBV	5	1000	178.0	8.4	3.2	3.2	1.4	4.0	8.0	Q3
LM4128BMF-2.5/NOPB	SOT-23	DBV	5	1000	178.0	8.4	3.2	3.2	1.4	4.0	8.0	Q3
LM4128BMF-3.0/NOPB	SOT-23	DBV	5	1000	178.0	8.4	3.2	3.2	1.4	4.0	8.0	Q3
LM4128BMF-3.3/NOPB	SOT-23	DBV	5	1000	178.0	8.4	3.2	3.2	1.4	4.0	8.0	Q3
LM4128BMF-4.1/NOPB	SOT-23	DBV	5	1000	178.0	8.4	3.2	3.2	1.4	4.0	8.0	Q3
LM4128BMFX-1.8/NOPB	SOT-23	DBV	5	3000	178.0	8.4	3.2	3.2	1.4	4.0	8.0	Q3
LM4128BMFX-2.0/NOPB	SOT-23	DBV	5	3000	178.0	8.4	3.2	3.2	1.4	4.0	8.0	Q3
LM4128BMFX-2.5/NOPB	SOT-23	DBV	5	3000	178.0	8.4	3.2	3.2	1.4	4.0	8.0	Q3
LM4128BMFX-3.0/NOPB	SOT-23	DBV	5	3000	178.0	8.4	3.2	3.2	1.4	4.0	8.0	Q3
LM4128BMFX-3.3/NOPB	SOT-23	DBV	5	3000	178.0	8.4	3.2	3.2	1.4	4.0	8.0	Q3
LM4128BMFX-4.1/NOPB	SOT-23	DBV	5	3000	178.0	8.4	3.2	3.2	1.4	4.0	8.0	Q3
LM4128BQ1MF1.8/NOPB	SOT-23	DBV	5	1000	178.0	8.4	3.2	3.2	1.4	4.0	8.0	Q3
LM4128BQ1MF2.0/NOPB	SOT-23	DBV	5	1000	178.0	8.4	3.2	3.2	1.4	4.0	8.0	Q3
LM4128BQ1MF2.5/NOPB	SOT-23	DBV	5	1000	178.0	8.4	3.2	3.2	1.4	4.0	8.0	Q3
LM4128BQ1MF3.0/NOPB	SOT-23	DBV	5	1000	178.0	8.4	3.2	3.2	1.4	4.0	8.0	Q3
LM4128BQ1MF3.3/NOPB	SOT-23	DBV	5	1000	178.0	8.4	3.2	3.2	1.4	4.0	8.0	Q3
LM4128BQ1MF4.1/NOPB	SOT-23	DBV	5	1000	178.0	8.4	3.2	3.2	1.4	4.0	8.0	Q3
LM4128BQ1MFX1.8/NOPB	SOT-23	DBV	5	3000	178.0	8.4	3.2	3.2	1.4	4.0	8.0	Q3
LM4128BQ1MFX2.0/NOPB	SOT-23	DBV	5	3000	178.0	8.4	3.2	3.2	1.4	4.0	8.0	Q3
LM4128BQ1MFX2.5/NOPB	SOT-23	DBV	5	3000	178.0	8.4	3.2	3.2	1.4	4.0	8.0	Q3
LM4128BQ1MFX3.0/NOPB	SOT-23	DBV	5	3000	178.0	8.4	3.2	3.2	1.4	4.0	8.0	Q3
LM4128BQ1MFX3.3/NOPB	SOT-23	DBV	5	3000	178.0	8.4	3.2	3.2	1.4	4.0	8.0	Q3
LM4128BQ1MFX4.1/NOPB	SOT-23	DBV	5	3000	178.0	8.4	3.2	3.2	1.4	4.0	8.0	Q3
LM4128CMF-1.8/NOPB	SOT-23	DBV	5	1000	178.0	8.4	3.2	3.2	1.4	4.0	8.0	Q3
LM4128CMF-2.0/NOPB	SOT-23	DBV	5	1000	178.0	8.4	3.2	3.2	1.4	4.0	8.0	Q3
LM4128CMF-2.5/NOPB	SOT-23	DBV	5	1000	178.0	8.4	3.2	3.2	1.4	4.0	8.0	Q3

Device	Package Type	Package Drawing	Pins	SPQ	Reel Diameter (mm)	Reel Width W1 (mm)	A0 (mm)	B0 (mm)	K0 (mm)	P1 (mm)	W (mm)	Pin1 Quadrant
LM4128CMF-3.0/NOPB	SOT-23	DBV	5	1000	178.0	8.4	3.2	3.2	1.4	4.0	8.0	Q3
LM4128CMF-3.3/NOPB	SOT-23	DBV	5	1000	178.0	8.4	3.2	3.2	1.4	4.0	8.0	Q3
LM4128CMF-4.1/NOPB	SOT-23	DBV	5	1000	178.0	8.4	3.2	3.2	1.4	4.0	8.0	Q3
LM4128CMFX-1.8/NOPB	SOT-23	DBV	5	3000	178.0	8.4	3.2	3.2	1.4	4.0	8.0	Q3
LM4128CMFX-2.0/NOPB	SOT-23	DBV	5	3000	178.0	8.4	3.2	3.2	1.4	4.0	8.0	Q3
LM4128CMFX-2.5/NOPB	SOT-23	DBV	5	3000	178.0	8.4	3.2	3.2	1.4	4.0	8.0	Q3
LM4128CMFX-3.0/NOPB	SOT-23	DBV	5	3000	178.0	8.4	3.2	3.2	1.4	4.0	8.0	Q3
LM4128CMFX-3.3/NOPB	SOT-23	DBV	5	3000	178.0	8.4	3.2	3.2	1.4	4.0	8.0	Q3
LM4128CMFX-4.1/NOPB	SOT-23	DBV	5	3000	178.0	8.4	3.2	3.2	1.4	4.0	8.0	Q3
LM4128CQ1MF1.8/NOPB	SOT-23	DBV	5	1000	178.0	8.4	3.2	3.2	1.4	4.0	8.0	Q3
LM4128CQ1MF2.0/NOPB	SOT-23	DBV	5	1000	178.0	8.4	3.2	3.2	1.4	4.0	8.0	Q3
LM4128CQ1MF2.5/NOPB	SOT-23	DBV	5	1000	178.0	8.4	3.2	3.2	1.4	4.0	8.0	Q3
LM4128CQ1MF3.0/NOPB	SOT-23	DBV	5	1000	178.0	8.4	3.2	3.2	1.4	4.0	8.0	Q3
LM4128CQ1MF3.3/NOPB	SOT-23	DBV	5	1000	178.0	8.4	3.2	3.2	1.4	4.0	8.0	Q3
LM4128CQ1MF4.1/NOPB	SOT-23	DBV	5	1000	178.0	8.4	3.2	3.2	1.4	4.0	8.0	Q3
LM4128CQ1MFX1.8/NOPB	SOT-23	DBV	5	3000	178.0	8.4	3.2	3.2	1.4	4.0	8.0	Q3
LM4128CQ1MFX2.0/NOPB	SOT-23	DBV	5	3000	178.0	8.4	3.2	3.2	1.4	4.0	8.0	Q3
LM4128CQ1MFX2.5/NOPB	SOT-23	DBV	5	3000	178.0	8.4	3.2	3.2	1.4	4.0	8.0	Q3
LM4128CQ1MFX3.0/NOPB	SOT-23	DBV	5	3000	178.0	8.4	3.2	3.2	1.4	4.0	8.0	Q3
LM4128CQ1MFX3.3/NOPB	SOT-23	DBV	5	3000	178.0	8.4	3.2	3.2	1.4	4.0	8.0	Q3
LM4128CQ1MFX4.1/NOPB	SOT-23	DBV	5	3000	178.0	8.4	3.2	3.2	1.4	4.0	8.0	Q3
LM4128DMF-1.8/NOPB	SOT-23	DBV	5	1000	178.0	8.4	3.2	3.2	1.4	4.0	8.0	Q3
LM4128DMF-2.0/NOPB	SOT-23	DBV	5	1000	178.0	8.4	3.2	3.2	1.4	4.0	8.0	Q3
LM4128DMF-2.5/NOPB	SOT-23	DBV	5	1000	178.0	8.4	3.2	3.2	1.4	4.0	8.0	Q3
LM4128DMF-3.0/NOPB	SOT-23	DBV	5	1000	178.0	8.4	3.2	3.2	1.4	4.0	8.0	Q3
LM4128DMF-3.3/NOPB	SOT-23	DBV	5	1000	178.0	8.4	3.2	3.2	1.4	4.0	8.0	Q3
LM4128DMF-4.1/NOPB	SOT-23	DBV	5	1000	178.0	8.4	3.2	3.2	1.4	4.0	8.0	Q3
LM4128DMFX-1.8/NOPB	SOT-23	DBV	5	3000	178.0	8.4	3.2	3.2	1.4	4.0	8.0	Q3
LM4128DMFX-2.0/NOPB	SOT-23	DBV	5	3000	178.0	8.4	3.2	3.2	1.4	4.0	8.0	Q3
LM4128DMFX-3.0/NOPB	SOT-23	DBV	5	3000	178.0	8.4	3.2	3.2	1.4	4.0	8.0	Q3
LM4128DMFX-3.3/NOPB	SOT-23	DBV	5	3000	178.0	8.4	3.2	3.2	1.4	4.0	8.0	Q3
LM4128DMFX-4.1/NOPB	SOT-23	DBV	5	3000	178.0	8.4	3.2	3.2	1.4	4.0	8.0	Q3
LM4128DQ1MF1.8/NOPB	SOT-23	DBV	5	1000	178.0	8.4	3.2	3.2	1.4	4.0	8.0	Q3
LM4128DQ1MF2.0/NOPB	SOT-23	DBV	5	1000	178.0	8.4	3.2	3.2	1.4	4.0	8.0	Q3
LM4128DQ1MF2.5/NOPB	SOT-23	DBV	5	1000	178.0	8.4	3.2	3.2	1.4	4.0	8.0	Q3
LM4128DQ1MF3.0/NOPB	SOT-23	DBV	5	1000	178.0	8.4	3.2	3.2	1.4	4.0	8.0	Q3
LM4128DQ1MF3.3/NOPB	SOT-23	DBV	5	1000	178.0	8.4	3.2	3.2	1.4	4.0	8.0	Q3
LM4128DQ1MF4.1/NOPB	SOT-23	DBV	5	1000	178.0	8.4	3.2	3.2	1.4	4.0	8.0	Q3
LM4128DQ1MFX1.8/NOPB	SOT-23	DBV	5	3000	178.0	8.4	3.2	3.2	1.4	4.0	8.0	Q3

Device	Package Type	Package Drawing	Pins	SPQ	Reel Diameter (mm)	Reel Width W1 (mm)	A0 (mm)	B0 (mm)	K0 (mm)	P1 (mm)	W (mm)	Pin1 Quadrant
B												
LM4128DQ1MFX2.0/NOPB	SOT-23	DBV	5	3000	178.0	8.4	3.2	3.2	1.4	4.0	8.0	Q3
LM4128DQ1MFX2.5/NOPB	SOT-23	DBV	5	3000	178.0	8.4	3.2	3.2	1.4	4.0	8.0	Q3
LM4128DQ1MFX3.0/NOPB	SOT-23	DBV	5	3000	178.0	8.4	3.2	3.2	1.4	4.0	8.0	Q3
LM4128DQ1MFX3.3/NOPB	SOT-23	DBV	5	3000	178.0	8.4	3.2	3.2	1.4	4.0	8.0	Q3
LM4128DQ1MFX4.1/NOPB	SOT-23	DBV	5	3000	178.0	8.4	3.2	3.2	1.4	4.0	8.0	Q3

### TAPE AND REEL BOX DIMENSIONS



\*All dimensions are nominal

Device	Package Type	Package Drawing	Pins	SPQ	Length (mm)	Width (mm)	Height (mm)
LM4128AMF-1.8/NOPB	SOT-23	DBV	5	1000	210.0	185.0	35.0
LM4128AMF-2.0/NOPB	SOT-23	DBV	5	1000	210.0	185.0	35.0
LM4128AMF-2.5/NOPB	SOT-23	DBV	5	1000	210.0	185.0	35.0
LM4128AMF-3.0/NOPB	SOT-23	DBV	5	1000	210.0	185.0	35.0
LM4128AMF-3.3/NOPB	SOT-23	DBV	5	1000	210.0	185.0	35.0
LM4128AMF-4.1/NOPB	SOT-23	DBV	5	1000	210.0	185.0	35.0
LM4128AMFX-1.8/NOPB	SOT-23	DBV	5	3000	210.0	185.0	35.0

Device	Package Type	Package Drawing	Pins	SPQ	Length (mm)	Width (mm)	Height (mm)
LM4128AMFX-2.0/NOPB	SOT-23	DBV	5	3000	210.0	185.0	35.0
LM4128AMFX-2.5/NOPB	SOT-23	DBV	5	3000	210.0	185.0	35.0
LM4128AMFX-3.0/NOPB	SOT-23	DBV	5	3000	210.0	185.0	35.0
LM4128AMFX-3.3/NOPB	SOT-23	DBV	5	3000	210.0	185.0	35.0
LM4128AMFX-4.1/NOPB	SOT-23	DBV	5	3000	210.0	185.0	35.0
LM4128AQ1MF1.8/NOPB	SOT-23	DBV	5	1000	210.0	185.0	35.0
LM4128AQ1MF2.0/NOPB	SOT-23	DBV	5	1000	210.0	185.0	35.0
LM4128AQ1MF2.5/NOPB	SOT-23	DBV	5	1000	210.0	185.0	35.0
LM4128AQ1MF3.0/NOPB	SOT-23	DBV	5	1000	210.0	185.0	35.0
LM4128AQ1MF3.3/NOPB	SOT-23	DBV	5	1000	210.0	185.0	35.0
LM4128AQ1MF4.1/NOPB	SOT-23	DBV	5	1000	210.0	185.0	35.0
LM4128AQ1MFX1.8/NOPB	SOT-23	DBV	5	3000	210.0	185.0	35.0
LM4128AQ1MFX2.0/NOPB	SOT-23	DBV	5	3000	210.0	185.0	35.0
LM4128AQ1MFX2.5/NOPB	SOT-23	DBV	5	3000	210.0	185.0	35.0
LM4128AQ1MFX3.0/NOPB	SOT-23	DBV	5	3000	210.0	185.0	35.0
LM4128AQ1MFX3.3/NOPB	SOT-23	DBV	5	3000	210.0	185.0	35.0
LM4128AQ1MFX4.1/NOPB	SOT-23	DBV	5	3000	210.0	185.0	35.0
LM4128BMF-1.8/NOPB	SOT-23	DBV	5	1000	210.0	185.0	35.0
LM4128BMF-2.0/NOPB	SOT-23	DBV	5	1000	210.0	185.0	35.0
LM4128BMF-2.5	SOT-23	DBV	5	1000	210.0	185.0	35.0
LM4128BMF-2.5/NOPB	SOT-23	DBV	5	1000	210.0	185.0	35.0
LM4128BMF-3.0/NOPB	SOT-23	DBV	5	1000	210.0	185.0	35.0
LM4128BMF-3.3/NOPB	SOT-23	DBV	5	1000	210.0	185.0	35.0
LM4128BMF-4.1/NOPB	SOT-23	DBV	5	1000	210.0	185.0	35.0
LM4128BMFX-1.8/NOPB	SOT-23	DBV	5	3000	210.0	185.0	35.0
LM4128BMFX-2.0/NOPB	SOT-23	DBV	5	3000	210.0	185.0	35.0
LM4128BMFX-2.5/NOPB	SOT-23	DBV	5	3000	210.0	185.0	35.0
LM4128BMFX-3.0/NOPB	SOT-23	DBV	5	3000	210.0	185.0	35.0
LM4128BMFX-3.3/NOPB	SOT-23	DBV	5	3000	210.0	185.0	35.0
LM4128BMFX-4.1/NOPB	SOT-23	DBV	5	3000	210.0	185.0	35.0
LM4128BQ1MF1.8/NOPB	SOT-23	DBV	5	1000	210.0	185.0	35.0
LM4128BQ1MF2.0/NOPB	SOT-23	DBV	5	1000	210.0	185.0	35.0
LM4128BQ1MF2.5/NOPB	SOT-23	DBV	5	1000	210.0	185.0	35.0
LM4128BQ1MF3.0/NOPB	SOT-23	DBV	5	1000	210.0	185.0	35.0
LM4128BQ1MF3.3/NOPB	SOT-23	DBV	5	1000	210.0	185.0	35.0
LM4128BQ1MF4.1/NOPB	SOT-23	DBV	5	1000	210.0	185.0	35.0
LM4128BQ1MFX1.8/NOPB	SOT-23	DBV	5	3000	210.0	185.0	35.0
LM4128BQ1MFX2.0/NOPB	SOT-23	DBV	5	3000	210.0	185.0	35.0
LM4128BQ1MFX2.5/NOPB	SOT-23	DBV	5	3000	210.0	185.0	35.0
LM4128BQ1MFX3.0/NOPB	SOT-23	DBV	5	3000	210.0	185.0	35.0
LM4128BQ1MFX3.3/NOPB	SOT-23	DBV	5	3000	210.0	185.0	35.0
LM4128BQ1MFX4.1/NOPB	SOT-23	DBV	5	3000	210.0	185.0	35.0
LM4128CMF-1.8/NOPB	SOT-23	DBV	5	1000	210.0	185.0	35.0
LM4128CMF-2.0/NOPB	SOT-23	DBV	5	1000	210.0	185.0	35.0

Device	Package Type	Package Drawing	Pins	SPQ	Length (mm)	Width (mm)	Height (mm)
LM4128CMF-2.5/NOPB	SOT-23	DBV	5	1000	210.0	185.0	35.0
LM4128CMF-3.0/NOPB	SOT-23	DBV	5	1000	210.0	185.0	35.0
LM4128CMF-3.3/NOPB	SOT-23	DBV	5	1000	210.0	185.0	35.0
LM4128CMF-4.1/NOPB	SOT-23	DBV	5	1000	210.0	185.0	35.0
LM4128CMFX-1.8/NOPB	SOT-23	DBV	5	3000	210.0	185.0	35.0
LM4128CMFX-2.0/NOPB	SOT-23	DBV	5	3000	210.0	185.0	35.0
LM4128CMFX-2.5/NOPB	SOT-23	DBV	5	3000	210.0	185.0	35.0
LM4128CMFX-3.0/NOPB	SOT-23	DBV	5	3000	210.0	185.0	35.0
LM4128CMFX-3.3/NOPB	SOT-23	DBV	5	3000	210.0	185.0	35.0
LM4128CMFX-4.1/NOPB	SOT-23	DBV	5	3000	210.0	185.0	35.0
LM4128CQ1MF1.8/NOPB	SOT-23	DBV	5	1000	210.0	185.0	35.0
LM4128CQ1MF2.0/NOPB	SOT-23	DBV	5	1000	210.0	185.0	35.0
LM4128CQ1MF2.5/NOPB	SOT-23	DBV	5	1000	210.0	185.0	35.0
LM4128CQ1MF3.0/NOPB	SOT-23	DBV	5	1000	210.0	185.0	35.0
LM4128CQ1MF3.3/NOPB	SOT-23	DBV	5	1000	210.0	185.0	35.0
LM4128CQ1MF4.1/NOPB	SOT-23	DBV	5	1000	210.0	185.0	35.0
LM4128CQ1MFX1.8/NOP B	SOT-23	DBV	5	3000	210.0	185.0	35.0
LM4128CQ1MFX2.0/NOP B	SOT-23	DBV	5	3000	210.0	185.0	35.0
LM4128CQ1MFX2.5/NOP B	SOT-23	DBV	5	3000	210.0	185.0	35.0
LM4128CQ1MFX3.0/NOP B	SOT-23	DBV	5	3000	210.0	185.0	35.0
LM4128CQ1MFX3.3/NOP B	SOT-23	DBV	5	3000	210.0	185.0	35.0
LM4128CQ1MFX4.1/NOP B	SOT-23	DBV	5	3000	210.0	185.0	35.0
LM4128DMF-1.8/NOPB	SOT-23	DBV	5	1000	210.0	185.0	35.0
LM4128DMF-2.0/NOPB	SOT-23	DBV	5	1000	210.0	185.0	35.0
LM4128DMF-2.5/NOPB	SOT-23	DBV	5	1000	210.0	185.0	35.0
LM4128DMF-3.0/NOPB	SOT-23	DBV	5	1000	210.0	185.0	35.0
LM4128DMF-3.3/NOPB	SOT-23	DBV	5	1000	210.0	185.0	35.0
LM4128DMF-4.1/NOPB	SOT-23	DBV	5	1000	210.0	185.0	35.0
LM4128DMFX-1.8/NOPB	SOT-23	DBV	5	3000	210.0	185.0	35.0
LM4128DMFX-2.0/NOPB	SOT-23	DBV	5	3000	210.0	185.0	35.0
LM4128DMFX-3.0/NOPB	SOT-23	DBV	5	3000	210.0	185.0	35.0
LM4128DMFX-3.3/NOPB	SOT-23	DBV	5	3000	210.0	185.0	35.0
LM4128DMFX-4.1/NOPB	SOT-23	DBV	5	3000	210.0	185.0	35.0
LM4128DQ1MF1.8/NOPB	SOT-23	DBV	5	1000	210.0	185.0	35.0
LM4128DQ1MF2.0/NOPB	SOT-23	DBV	5	1000	210.0	185.0	35.0
LM4128DQ1MF2.5/NOPB	SOT-23	DBV	5	1000	210.0	185.0	35.0
LM4128DQ1MF3.0/NOPB	SOT-23	DBV	5	1000	210.0	185.0	35.0
LM4128DQ1MF3.3/NOPB	SOT-23	DBV	5	1000	210.0	185.0	35.0
LM4128DQ1MF4.1/NOPB	SOT-23	DBV	5	1000	210.0	185.0	35.0
LM4128DQ1MFX1.8/NOP	SOT-23	DBV	5	3000	210.0	185.0	35.0

Device	Package Type	Package Drawing	Pins	SPQ	Length (mm)	Width (mm)	Height (mm)
B							
LM4128DQ1MFX2.0/NOP B	SOT-23	DBV	5	3000	210.0	185.0	35.0
LM4128DQ1MFX2.5/NOP B	SOT-23	DBV	5	3000	210.0	185.0	35.0
LM4128DQ1MFX3.0/NOP B	SOT-23	DBV	5	3000	210.0	185.0	35.0
LM4128DQ1MFX3.3/NOP B	SOT-23	DBV	5	3000	210.0	185.0	35.0
LM4128DQ1MFX4.1/NOP B	SOT-23	DBV	5	3000	210.0	185.0	35.0

DBV0005A



# PACKAGE OUTLINE

SOT-23 - 1.45 mm max height

SMALL OUTLINE TRANSISTOR



4214839/D 11/2018

NOTES:

1. All linear dimensions are in millimeters. Any dimensions in parenthesis are for reference only. Dimensioning and tolerancing per ASME Y14.5M.
2. This drawing is subject to change without notice.
3. Reference JEDEC MO-178.
4. Body dimensions do not include mold flash, protrusions, or gate burrs. Mold flash, protrusions, or gate burrs shall not exceed 0.15 mm per side.

# EXAMPLE BOARD LAYOUT

DBV0005A

SOT-23 - 1.45 mm max height

SMALL OUTLINE TRANSISTOR



LAND PATTERN EXAMPLE  
EXPOSED METAL SHOWN  
SCALE:15X

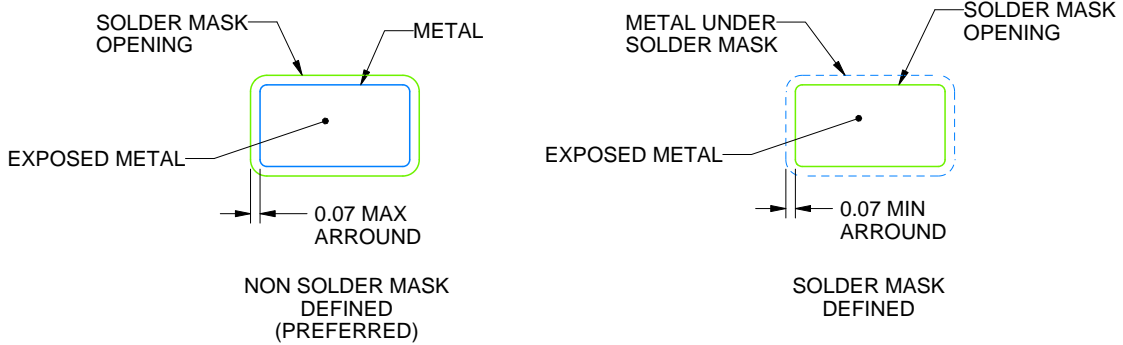

SOLDER MASK DETAILS

4214839/D 11/2018

NOTES: (continued)

- 5. Publication IPC-7351 may have alternate designs.
- 6. Solder mask tolerances between and around signal pads can vary based on board fabrication site.

# EXAMPLE STENCIL DESIGN

DBV0005A

SOT-23 - 1.45 mm max height

SMALL OUTLINE TRANSISTOR



SOLDER PASTE EXAMPLE  
BASED ON 0.125 mm THICK STENCIL  
SCALE:15X

4214839/D 11/2018

NOTES: (continued)

7. Laser cutting apertures with trapezoidal walls and rounded corners may offer better paste release. IPC-7525 may have alternate design recommendations.
8. Board assembly site may have different recommendations for stencil design.

## IMPORTANT NOTICE AND DISCLAIMER

TI PROVIDES TECHNICAL AND RELIABILITY DATA (INCLUDING DATASHEETS), DESIGN RESOURCES (INCLUDING REFERENCE DESIGNS), APPLICATION OR OTHER DESIGN ADVICE, WEB TOOLS, SAFETY INFORMATION, AND OTHER RESOURCES "AS IS" AND WITH ALL FAULTS, AND DISCLAIMS ALL WARRANTIES, EXPRESS AND IMPLIED, INCLUDING WITHOUT LIMITATION ANY IMPLIED WARRANTIES OF MERCHANTABILITY, FITNESS FOR A PARTICULAR PURPOSE OR NON-INFRINGEMENT OF THIRD PARTY INTELLECTUAL PROPERTY RIGHTS.

These resources are intended for skilled developers designing with TI products. You are solely responsible for (1) selecting the appropriate TI products for your application, (2) designing, validating and testing your application, and (3) ensuring your application meets applicable standards, and any other safety, security, or other requirements. These resources are subject to change without notice. TI grants you permission to use these resources only for development of an application that uses the TI products described in the resource. Other reproduction and display of these resources is prohibited. No license is granted to any other TI intellectual property right or to any third party intellectual property right. TI disclaims responsibility for, and you will fully indemnify TI and its representatives against, any claims, damages, costs, losses, and liabilities arising out of your use of these resources.

TI's products are provided subject to TI's Terms of Sale ([www.ti.com/legal/termsofsale.html](http://www.ti.com/legal/termsofsale.html)) or other applicable terms available either on [ti.com](http://ti.com) or provided in conjunction with such TI products. TI's provision of these resources does not expand or otherwise alter TI's applicable warranties or warranty disclaimers for TI products.

Mailing Address: Texas Instruments, Post Office Box 655303, Dallas, Texas 75265  
Copyright © 2019, Texas Instruments Incorporated

## Looking for pricing, stock, or lifecycle information?

Click below to explore more details on WIN SOURCE:

 [View LM4128AQ1MFX4.1/NOPB on WIN SOURCE](#)

 [Texas Instruments](#) Information

## Optimize Your Supply Chain with WIN SOURCE Solutions

-  Global Sourcing Solution
-  Obsolete Management
-  Cost Control Management
-  Shortage Management
-  Alternative Solution
-  Excess Inventory Management