



**THE DATASHEET OF
LM4132CMFX-3.0/NOPB**



LM4132, LM4132-Q1 SOT-23 Precision Low Dropout Voltage Reference

1 Features

- Qualified for Automotive Applications
- AEC-Q100 Qualified With the Following Results:
 - Device Temperature Grade 1: -40°C to $+125^{\circ}\text{C}$ Ambient Operating Temperature Range
 - Device HBM ESD Classification Level 2
- Output Initial Voltage Accuracy: 0.05%
- Low Temperature Coefficient: 10 ppm/ $^{\circ}\text{C}$
- Low Supply Current: 60 μA
- Enable Pin Allowing a 3- μA Shutdown Mode
- 20-mA Output Current
- Voltage Options: 1.8 V, 2.048 V, 2.5 V, 3 V, 3.3 V, 4.096 V
- Custom Voltage Options Available (1.8 V to 4.096 V)
- V_{IN} Range of $V_{\text{REF}} + 400 \text{ mV}$ to 5.5 V at 10 mA
- Stable With Low-ESR Ceramic Capacitors

2 Applications

- Instrumentation and Process Control
- Test Equipment
- Data Acquisition Systems
- Base Stations
- Servo Systems
- Portable, Battery-Powered Equipment
- Automotive and Industrial
- Precision Regulators
- Battery Chargers
- Communications
- Medical Equipment

3 Description

The LM4132 family of precision voltage references performs comparable to the best laser-trimmed bipolar references, but in cost-effective CMOS technology. The key to this breakthrough is the use of EEPROM registers for correction of curvature, temperature coefficient (tempco), and accuracy on a CMOS band-gap architecture allowing package-level programming to overcome assembly shift. The shifts in voltage accuracy and tempco during assembly of die into plastic packages limit the accuracy of references trimmed with laser techniques.

Unlike other LDO references, the LM4132 can deliver up to 20 mA and does not require an output capacitor or buffer amplifier. These advantages along with the SOT-23 packaging are important for space-critical applications.

Series references provide lower power consumption than shunt references, because they do not have to idle the maximum possible load current under no-load conditions. This advantage, the low quiescent current (60 μA), and the low dropout voltage (400 mV) make the LM4132 ideal for battery-powered solutions.

The LM4132 is available in five grades (A, B, C, D and E) for greater flexibility. The best grade devices (A) have an initial accuracy of 0.05% with a specified temperature coefficient of 10 ppm/ $^{\circ}\text{C}$ or less, while the lowest grade devices (E) have an initial accuracy of 0.5% and a tempco of 30 ppm/ $^{\circ}\text{C}$.

Device Information⁽¹⁾

| PART NUMBER | PACKAGE | BODY SIZE (NOM) |
|-------------------|------------|-------------------|
| LM4132, LM4132-Q1 | SOT-23 (5) | 2.90 mm x 1.60 mm |

(1) For all available packages, see the orderable addendum at the end of the data sheet.

Simplified Schematic



*The capacitor C_{IN} is required and the capacitor C_{OUT} is optional.



Table of Contents

| | | | | | |
|----------|--|----------|-----------|---|-----------|
| 1 | Features | 1 | 7 | Detailed Description | 20 |
| 2 | Applications | 1 | 7.1 | Overview | 20 |
| 3 | Description | 1 | 7.2 | Functional Block Diagram | 20 |
| 4 | Revision History | 2 | 7.3 | Feature Description | 20 |
| 5 | Pin Configuration and Functions | 3 | 7.4 | Device Functional Modes | 21 |
| 6 | Specifications | 3 | 8 | Applications and Implementation | 22 |
| 6.1 | Absolute Maximum Ratings | 3 | 8.1 | Application Information | 22 |
| 6.2 | ESD Ratings | 4 | 8.2 | Typical Applications | 22 |
| 6.3 | Recommended Operating Conditions | 4 | 9 | Power Supply Recommendations | 25 |
| 6.4 | Thermal Information | 4 | 10 | Layout | 26 |
| 6.5 | Electrical Characteristics LM4132-1.8 (V _{OUT} = 1.8 V) | 5 | 10.1 | Layout Guidelines | 26 |
| 6.6 | Electrical Characteristics LM4132-2 (V _{OUT} = 2.048 V) | 6 | 10.2 | Layout Example | 26 |
| 6.7 | Electrical Characteristics LM4132-2.5 (V _{OUT} = 2.5 V) | 7 | 11 | Device and Documentation Support | 27 |
| 6.8 | Electrical Characteristics LM4132-3 (V _{OUT} = 3 V) | 8 | 11.1 | Documentation Support | 27 |
| 6.9 | Electrical Characteristics LM4132-3.3 (V _{OUT} = 3.3 V) | 9 | 11.2 | Related Links | 27 |
| 6.10 | Electrical Characteristics LM4132-3.3- Q1(V _{OUT} = 3.3 V) | 10 | 11.3 | Receiving Notification of Documentation Updates | 27 |
| 6.11 | Electrical Characteristics LM4132-4.1 (V _{OUT} = 4.096 V) | 11 | 11.4 | Community Resources | 27 |
| 6.12 | Typical Characteristics | 12 | 11.5 | Trademarks | 27 |
| | | | 11.6 | Electrostatic Discharge Caution | 27 |
| | | | 11.7 | Glossary | 27 |
| | | | 12 | Mechanical, Packaging, and Orderable Information | 27 |

4 Revision History

NOTE: Page numbers for previous revisions may differ from page numbers in the current version.

| Changes from Revision F (March 2016) to Revision G | Page |
|--|-------------|
| • Updated data sheet text to the latest TI documentation and translations standards | 1 |
| • Added <i>LM4132-3.3-Q1</i> to <i>maximum load current</i> in <i>Recommended Operating Conditions</i> | 4 |
| • Added <i>Electrical Characteristics LM4132-3.3-Q1</i> table | 10 |
| Changes from Revision E (January 2016) to Revision F | Page |
| • Added correct <i>Layout Example</i> | 26 |
| Changes from Revision D (March 2015) to Revision E | Page |
| • Added <i>Device Information</i> , <i>ESD Ratings</i> and <i>Thermal Information</i> tables, <i>Feature Description</i> section, <i>Device Functional Modes</i> , <i>Application and Implementation</i> section, <i>Power Supply Recommendations</i> section, <i>Layout</i> section, <i>Device and Documentation Support</i> section, and <i>Mechanical, Packaging, and Orderable Information</i> section. | 1 |
| Changes from Revision C (April 2013) to Revision D | Page |
| • Added some of the latest inclusions from new TI formatting and made available of the automotive grade for the SOT-23 package | 1 |
| Changes from Revision B (August 2005) to Revision C | Page |
| • Changed layout of National Data Sheet to TI format | 25 |

5 Pin Configuration and Functions

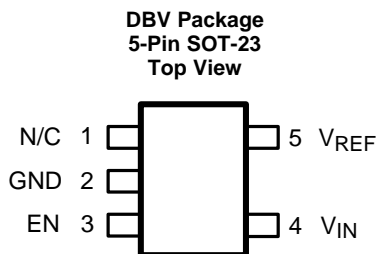

Pin Functions

| PIN | | I/O ⁽¹⁾ | DESCRIPTION |
|-----|------------------|--------------------|--------------------------------|
| NO. | NAME | | |
| 1 | N/C | — | No connect pin, leave floating |
| 2 | GND | G | Ground |
| 3 | EN | I | Enable pin |
| 4 | V _{IN} | P | Input supply |
| 5 | V _{REF} | P | Reference output |

(1) G: Ground; I: Input; P: Power

6 Specifications

6.1 Absolute Maximum Ratings

over operating free-air temperature range (unless otherwise noted)⁽¹⁾⁽²⁾

| | | MIN | MAX | UNIT |
|--|-------------------------------|------------|-----|------|
| Voltage | Maximum voltage on any input | –0.3 | 6 | V |
| | Output short-circuit duration | Indefinite | | |
| Power dissipation (T _A = 25°C) ⁽³⁾ | | | 350 | mW |
| Lead temperature (soldering, 10 sec) | | | 260 | °C |
| Vapor phase (60 sec) | | | 215 | °C |
| Infrared (15 sec) | | | 220 | °C |
| Storage temperature, T _{stg} | | –65 | 150 | °C |

- Stresses beyond those listed under *Absolute Maximum Ratings* may cause permanent damage to the device. These are stress ratings only, which do not imply functional operation of the device at these or any other conditions beyond those indicated under *Recommended Operating Conditions*. Exposure to absolute-maximum-rated conditions for extended periods may affect device reliability.
- If Military/Aerospace specified devices are required, contact the Texas Instruments Sales Office/Distributors for availability and specifications.
- Without PCB copper enhancements. The maximum power dissipation must be de-rated at elevated temperatures and is limited by T_{JMAX} (maximum junction temperature), R_{θJA} (junction to ambient thermal resistance) and T_A (ambient temperature). The maximum power dissipation at any temperature is: P_{DissMAX} = (T_{JMAX} – T_A) / R_{θJA} up to the value listed in the *Absolute Maximum Ratings*. R_{θJA} for SOT-23 is 164.1°C/W, T_{JMAX} = 125°C.

6.2 ESD Ratings

| | | VALUE | UNIT |
|-------------|--|-------|------|
| $V_{(ESD)}$ | Electrostatic discharge ⁽¹⁾ Human-body model (HBM), per AEC Q100-002 ⁽²⁾ | ±2000 | V |

(1) The Human body model is a 100-pF capacitor discharged through a 1.5-kΩ resistor into each pin.

(2) AEC Q100-002 indicates that HBM stressing shall be in accordance with the ANSI/ESDA/JEDEC JS-001 specification.

6.3 Recommended Operating Conditions

| | | MIN | NOM | MAX | UNIT |
|------------------------------|---------------|-----|-----|----------|------|
| Maximum input supply voltage | | | | 5.5 | V |
| Maximum enable input voltage | | | | V_{IN} | V |
| Maximum load current | LM4132 | | | 20 | mA |
| | LM4132-3.3-Q1 | | | 25 | mA |
| Junction temperature, T_J | | –40 | | 125 | °C |

6.4 Thermal Information

| THERMAL METRIC ⁽¹⁾ | | LM4132, LM4132-Q1 | UNIT |
|-------------------------------|--|-------------------|------|
| | | DBV (SOT-23) | |
| | | 5 PINS | |
| $R_{\theta JA}$ | Junction-to-ambient thermal resistance | 164.1 | °C/W |
| $R_{\theta JC(top)}$ | Junction-to-case (top) thermal resistance | 115.3 | °C/W |
| $R_{\theta JB}$ | Junction-to-board thermal resistance | 27.1 | °C/W |
| Ψ_{JT} | Junction-to-top characterization parameter | 12.8 | °C/W |
| Ψ_{JB} | Junction-to-board characterization parameter | 26.6 | °C/W |

(1) For more information about traditional and new thermal metrics, see the [Semiconductor and IC Package Thermal Metrics](#) application report.

6.5 Electrical Characteristics LM4132-1.8 ($V_{OUT} = 1.8\text{ V}$)

Unless otherwise specified, limits are $T_J = 25^\circ\text{C}$, $V_{IN} = 5\text{ V}$, and $I_{LOAD} = 0\text{ mA}$.

| PARAMETER | | TEST CONDITIONS | MIN ⁽¹⁾ | TYP ⁽²⁾ | MAX ⁽¹⁾ | UNIT |
|----------------------------------|-------------------------------------|---|---|--------------------|--------------------|-----------------------|
| V_{REF} | Output voltage initial accuracy | LM4132A-1.8 | (A Grade - 0.05%) | -0.05% | 0.05% | |
| | | LM4132B-1.8 | (B Grade - 0.1%) | -0.1% | 0.1% | |
| | | LM4132C-1.8 | (C Grade - 0.2%) | -0.2% | 0.2% | |
| | | LM4132D-1.8 | (D Grade - 0.4%) | -0.4% | 0.4% | |
| | | LM4132E-1.8 | (E Grade - 0.5%) | -0.5% | 0.5% | |
| $TCV_{REF}/^\circ\text{C}$ | Temperature coefficient | LM4132A-1.8 | $0^\circ\text{C} \leq T_J \leq 85^\circ\text{C}$ | | 10 | ppm/ $^\circ\text{C}$ |
| | | | $-40^\circ\text{C} \leq T_J \leq 125^\circ\text{C}$ | | 20 | |
| | | LM4132B-1.8 | $-40^\circ\text{C} \leq T_J \leq 125^\circ\text{C}$ | | 20 | |
| | | | | | 20 | |
| | | | | | 20 | |
| LM4132E-1.8 | | 30 | | | | |
| I_Q | Supply current | $-40^\circ\text{C} \leq T_J \leq 125^\circ\text{C}$ | | 60 | | μA |
| | | | | 100 | | |
| I_{Q_SD} | Supply current in shutdown | $-40^\circ\text{C} \leq T_J \leq 125^\circ\text{C}$ | EN = 0 V | 3 | | μA |
| | | | | 7 | | |
| $\Delta V_{REF}/\Delta V_{IN}$ | Line regulation | $V_{REF} + 400\text{ mV} \leq V_{IN} \leq 5.5\text{ V}$ | | 30 | | ppm/V |
| $\Delta V_{REF}/\Delta I_{LOAD}$ | Load regulation | $-40^\circ\text{C} \leq T_J \leq 125^\circ\text{C}$ | $0\text{ mA} \leq I_{LOAD} \leq 20\text{ mA}$ | 25 | | ppm/mA |
| | | | | | 120 | |
| ΔV_{REF} | Long-term stability ⁽³⁾ | 1000 Hrs | | 50 | | ppm |
| | Thermal hysteresis ⁽⁴⁾ | $-40^\circ\text{C} \leq T_J \leq 125^\circ\text{C}$ | | 75 | | |
| $V_{IN} - V_{REF}$ | Dropout voltage ⁽⁵⁾ | $-40^\circ\text{C} \leq T_J \leq 125^\circ\text{C}$ | $I_{LOAD} = 10\text{ mA}$ | 230 | | mV |
| | | | | | 400 | |
| V_N | Output noise voltage | 0.1 Hz to 10 Hz | | 170 | | μV_{PP} |
| I_{SC} | Short-circuit current | $-40^\circ\text{C} \leq T_J \leq 125^\circ\text{C}$ | | | 75 | mA |
| V_{IL} | Enable pin maximum low input level | $-40^\circ\text{C} \leq T_J \leq 125^\circ\text{C}$ | | | 35% (V_{IN}) | V |
| V_{IH} | Enable pin minimum high input level | $-40^\circ\text{C} \leq T_J \leq 125^\circ\text{C}$ | | 65% (V_{IN}) | | V |

- (1) Limits are 100% production tested at 25°C . Limits over the operating temperature range are specified through correlation using Statistical Quality Control.
- (2) Typical numbers are at 25°C and represent the most likely parametric norm.
- (3) Long-term stability is V_{REF} at 25°C measured during 1000 hrs.
- (4) Thermal hysteresis is defined as the change in 25°C output voltage before and after cycling the device from (-40°C to 125°C).
- (5) Dropout voltage is defined as the minimum input to output differential at which the output voltage drops by 0.5% below the value measured with a 5-V input.

6.6 Electrical Characteristics LM4132-2 ($V_{OUT} = 2.048\text{ V}$)

Unless otherwise specified, limits are $T_J = 25^\circ\text{C}$, $V_{IN} = 5\text{ V}$, and $I_{LOAD} = 0\text{ mA}$.

| PARAMETER | | TEST CONDITIONS | MIN ⁽¹⁾ | TYP ⁽²⁾ | MAX ⁽¹⁾ | UNIT |
|----------------------------------|-------------------------------------|---|---|--------------------|--------------------|-----------------------|
| V_{REF} | Output voltage initial accuracy | LM4132A-2.0 | (A Grade - 0.05%) | -0.05% | 0.05% | |
| | | LM4132B-2.0 | (B Grade - 0.1%) | -0.1% | 0.1% | |
| | | LM4132C-2.0 | (C Grade - 0.2%) | -0.2% | 0.2% | |
| | | LM4132D-2.0 | (D Grade - 0.4%) | -0.4% | 0.4% | |
| | | LM4132E-2.0 | (E Grade - 0.5%) | -0.5% | 0.5% | |
| $TCV_{REF}/^\circ\text{C}$ | Temperature coefficient | LM4132A-2.0 | $0^\circ\text{C} \leq T_J \leq 85^\circ\text{C}$ | | 10 | ppm/ $^\circ\text{C}$ |
| | | | $-40^\circ\text{C} \leq T_J \leq 125^\circ\text{C}$ | | 20 | |
| | | LM4132B-2.0 | $-40^\circ\text{C} \leq T_J \leq 125^\circ\text{C}$ | | 20 | |
| | | | | | 20 | |
| | | | | | 20 | |
| LM4132E-2.0 | | 30 | | | | |
| I_Q | Supply current | $-40^\circ\text{C} \leq T_J \leq 125^\circ\text{C}$ | | 60 | | μA |
| | | | | 100 | | |
| I_{Q_SD} | Supply current in shutdown | $-40^\circ\text{C} \leq T_J \leq 125^\circ\text{C}$ | EN = 0 V | 3 | | μA |
| | | | | 7 | | |
| $\Delta V_{REF}/\Delta V_{IN}$ | Line regulation | $V_{REF} + 400\text{ mV} \leq V_{IN} \leq 5.5\text{ V}$ | | 30 | | ppm/V |
| $\Delta V_{REF}/\Delta I_{LOAD}$ | Load regulation | $-40^\circ\text{C} \leq T_J \leq 125^\circ\text{C}$ | $0\text{ mA} \leq I_{LOAD} \leq 20\text{ mA}$ | 25 | | ppm/mA |
| | | | | | 120 | |
| ΔV_{REF} | Long-term stability ⁽³⁾ | 1000 Hrs | | 50 | | ppm |
| | Thermal hysteresis ⁽⁴⁾ | $-40^\circ\text{C} \leq T_J \leq 125^\circ\text{C}$ | | 75 | | |
| $V_{IN} - V_{REF}$ | Dropout voltage ⁽⁵⁾ | $-40^\circ\text{C} \leq T_J \leq 125^\circ\text{C}$ | $I_{LOAD} = 10\text{ mA}$ | 175 | | mV |
| | | | | | 400 | |
| V_N | Output noise voltage | 0.1 Hz to 10 Hz | | 190 | | μV_{PP} |
| I_{SC} | Short-circuit current | $-40^\circ\text{C} \leq T_J \leq 125^\circ\text{C}$ | | | 75 | mA |
| V_{IL} | Enable pin maximum low input level | $-40^\circ\text{C} \leq T_J \leq 125^\circ\text{C}$ | | | 35% (V_{IN}) | V |
| V_{IH} | Enable pin minimum high input level | $-40^\circ\text{C} \leq T_J \leq 125^\circ\text{C}$ | | 65% (V_{IN}) | | V |

- (1) Limits are 100% production tested at 25°C . Limits over the operating temperature range are specified through correlation using Statistical Quality Control.
- (2) Typical numbers are at 25°C and represent the most likely parametric norm.
- (3) Long-term stability is V_{REF} at 25°C measured during 1000 hrs.
- (4) Thermal hysteresis is defined as the change in 25°C output voltage before and after cycling the device from (-40°C to 125°C).
- (5) Dropout voltage is defined as the minimum input to output differential at which the output voltage drops by 0.5% below the value measured with a 5-V input.

6.7 Electrical Characteristics LM4132-2.5 ($V_{OUT} = 2.5\text{ V}$)

Unless otherwise specified, limits are $T_J = 25^\circ\text{C}$, $V_{IN} = 5\text{ V}$, and $I_{LOAD} = 0\text{ mA}$.

| PARAMETER | | TEST CONDITIONS | MIN ⁽¹⁾ | TYP ⁽²⁾ | MAX ⁽¹⁾ | UNIT |
|----------------------------------|-------------------------------------|---|---|--------------------|--------------------|-----------------------|
| V_{REF} | Output voltage initial accuracy | LM4132A-2.5 | (A Grade - 0.05%) | -0.05% | 0.05% | |
| | | LM4132B-2.5 | (B Grade - 0.1%) | -0.1% | 0.1% | |
| | | LM4132C-2.5 | (C Grade - 0.2%) | -0.2% | 0.2% | |
| | | LM4132D-2.5 | (D Grade - 0.4%) | -0.4% | 0.4% | |
| | | LM4132E-2.5 | (E Grade - 0.5%) | -0.5% | 0.5% | |
| $TCV_{REF}/^\circ\text{C}$ | Temperature coefficient | LM4132A-2.5 | $0^\circ\text{C} \leq T_J \leq 85^\circ\text{C}$ | | 10 | ppm/ $^\circ\text{C}$ |
| | | | $-40^\circ\text{C} \leq T_J \leq 125^\circ\text{C}$ | | 20 | |
| | | LM4132B-2.5 | $-40^\circ\text{C} \leq T_J \leq 125^\circ\text{C}$ | | 20 | |
| | | | | | 20 | |
| | | | | | 20 | |
| LM4132E-2.5 | | 30 | | | | |
| I_Q | Supply current | $-40^\circ\text{C} \leq T_J \leq 125^\circ\text{C}$ | | 60 | | μA |
| | | | | 100 | | |
| I_{Q_SD} | Supply current in shutdown | $-40^\circ\text{C} \leq T_J \leq 125^\circ\text{C}$ | EN = 0 V | 3 | | μA |
| | | | | 7 | | |
| $\Delta V_{REF}/\Delta V_{IN}$ | Line regulation | $V_{REF} + 400\text{ mV} \leq V_{IN} \leq 5.5\text{ V}$ | | 50 | | ppm/V |
| $\Delta V_{REF}/\Delta I_{LOAD}$ | Load regulation | $-40^\circ\text{C} \leq T_J \leq 125^\circ\text{C}$ | $0\text{ mA} \leq I_{LOAD} \leq 20\text{ mA}$ | 25 | | ppm/mA |
| | | | | | 120 | |
| ΔV_{REF} | Long-term stability ⁽³⁾ | 1000 Hrs | | 50 | | ppm |
| | Thermal hysteresis ⁽⁴⁾ | $-40^\circ\text{C} \leq T_J \leq 125^\circ\text{C}$ | | 75 | | |
| $V_{IN} - V_{REF}$ | Dropout voltage ⁽⁵⁾ | $-40^\circ\text{C} \leq T_J \leq 125^\circ\text{C}$ | $I_{LOAD} = 10\text{ mA}$ | 175 | | mV |
| | | | | | 400 | |
| V_N | Output noise voltage | 0.1 Hz to 10 Hz | | 240 | | μV_{PP} |
| I_{SC} | Short-circuit current | $-40^\circ\text{C} \leq T_J \leq 125^\circ\text{C}$ | | | 75 | mA |
| V_{IL} | Enable pin maximum low input level | $-40^\circ\text{C} \leq T_J \leq 125^\circ\text{C}$ | | | 35% (V_{IN}) | V |
| V_{IH} | Enable pin minimum high input level | $-40^\circ\text{C} \leq T_J \leq 125^\circ\text{C}$ | | 65% (V_{IN}) | | V |

- (1) Limits are 100% production tested at 25°C . Limits over the operating temperature range are specified through correlation using Statistical Quality Control.
- (2) Typical numbers are at 25°C and represent the most likely parametric norm.
- (3) Long-term stability is V_{REF} at 25°C measured during 1000 hrs.
- (4) Thermal hysteresis is defined as the change in 25°C output voltage before and after cycling the device from (-40°C to 125°C).
- (5) Dropout voltage is defined as the minimum input to output differential at which the output voltage drops by 0.5% below the value measured with a 5-V input.

6.8 Electrical Characteristics LM4132-3 ($V_{OUT} = 3\text{ V}$)

Unless otherwise specified, limits are $T_J = 25^\circ\text{C}$, $V_{IN} = 5\text{ V}$, and $I_{LOAD} = 0\text{ mA}$.

| PARAMETER | | TEST CONDITIONS | MIN ⁽¹⁾ | TYP ⁽²⁾ | MAX ⁽¹⁾ | UNIT |
|----------------------------------|-------------------------------------|---|---|--------------------|--------------------|-----------------------|
| V_{REF} | Output voltage initial accuracy | LM4132A-3.0 | (A Grade - 0.05%) | -0.05% | 0.05% | |
| | | LM4132B-3.0 | (B Grade - 0.1%) | -0.1% | 0.1% | |
| | | LM4132C-3.0 | (C Grade - 0.2%) | -0.2% | 0.2% | |
| | | LM4132D-3.0 | (D Grade - 0.4%) | -0.4% | 0.4% | |
| | | LM4132E-3.0 | (E Grade - 0.5%) | -0.5% | 0.5% | |
| $TCV_{REF}/^\circ\text{C}$ | Temperature coefficient | LM4132A-3.0 | $0^\circ\text{C} \leq T_J \leq 85^\circ\text{C}$ | | 10 | ppm/ $^\circ\text{C}$ |
| | | | $-40^\circ\text{C} \leq T_J \leq 125^\circ\text{C}$ | | 20 | |
| | | LM4132B-3.0 | $-40^\circ\text{C} \leq T_J \leq 125^\circ\text{C}$ | | 20 | |
| | | | | | 20 | |
| | | | | | 20 | |
| LM4132E-3.0 | | 30 | | | | |
| I_Q | Supply current | $-40^\circ\text{C} \leq T_J \leq 125^\circ\text{C}$ | | 60 | | μA |
| | | | | 100 | | |
| I_{Q_SD} | Supply current in shutdown | $-40^\circ\text{C} \leq T_J \leq 125^\circ\text{C}$ | EN = 0 V | 3 | | μA |
| | | | | 7 | | |
| $\Delta V_{REF}/\Delta V_{IN}$ | Line regulation | $V_{REF} + 400\text{ mV} \leq V_{IN} \leq 5.5\text{ V}$ | | 70 | | ppm/V |
| $\Delta V_{REF}/\Delta I_{LOAD}$ | Load regulation | $-40^\circ\text{C} \leq T_J \leq 125^\circ\text{C}$ | $0\text{ mA} \leq I_{LOAD} \leq 20\text{ mA}$ | 25 | | ppm/mA |
| | | | | | 120 | |
| ΔV_{REF} | Long-term stability ⁽³⁾ | 1000 Hrs | | 50 | | ppm |
| | Thermal hysteresis ⁽⁴⁾ | $-40^\circ\text{C} \leq T_J \leq 125^\circ\text{C}$ | | 75 | | |
| $V_{IN} - V_{REF}$ | Dropout voltage ⁽⁵⁾ | $-40^\circ\text{C} \leq T_J \leq 125^\circ\text{C}$ | $I_{LOAD} = 10\text{ mA}$ | 175 | | mV |
| | | | | | 400 | |
| V_N | Output noise voltage | 0.1 Hz to 10 Hz | | 285 | | μV_{PP} |
| I_{SC} | Short-circuit current | $-40^\circ\text{C} \leq T_J \leq 125^\circ\text{C}$ | | | 75 | mA |
| V_{IL} | Enable pin maximum low input level | $-40^\circ\text{C} \leq T_J \leq 125^\circ\text{C}$ | | | 35% (V_{IN}) | V |
| V_{IH} | Enable pin minimum high input level | $-40^\circ\text{C} \leq T_J \leq 125^\circ\text{C}$ | | 65% (V_{IN}) | | V |

(1) Limits are 100% production tested at 25°C . Limits over the operating temperature range are specified through correlation using Statistical Quality Control.

(2) Typical numbers are at 25°C and represent the most likely parametric norm.

(3) Long-term stability is V_{REF} at 25°C measured during 1000 hrs.

(4) Thermal hysteresis is defined as the change in 25°C output voltage before and after cycling the device from (-40°C to 125°C).

(5) Dropout voltage is defined as the minimum input to output differential at which the output voltage drops by 0.5% below the value measured with a 5-V input.

6.9 Electrical Characteristics LM4132-3.3 ($V_{OUT} = 3.3\text{ V}$)

Unless otherwise specified, limits are $T_J = 25^\circ\text{C}$, $V_{IN} = 5\text{ V}$, and $I_{LOAD} = 0\text{ mA}$.

| PARAMETER | | TEST CONDITIONS | MIN ⁽¹⁾ | TYP ⁽²⁾ | MAX ⁽¹⁾ | UNIT |
|----------------------------------|-------------------------------------|---|---|--------------------|--------------------|-----------------------|
| V_{REF} | Output voltage initial accuracy | LM4132A-3.3 | (A Grade - 0.05%) | -0.05% | 0.05% | |
| | | LM4132B-3.3 | (B Grade - 0.1%) | -0.1% | 0.1% | |
| | | LM4132C-3.3 | (C Grade - 0.2%) | -0.2% | 0.2% | |
| | | LM4132D-3.3 | (D Grade - 0.4%) | -0.4% | 0.4% | |
| | | LM4132E-3.3 | (E Grade - 0.5%) | -0.5% | 0.5% | |
| $TCV_{REF}/^\circ\text{C}$ | Temperature coefficient | LM4132A-3.3 | $0^\circ\text{C} \leq T_J \leq 85^\circ\text{C}$ | | 10 | ppm/ $^\circ\text{C}$ |
| | | | $-40^\circ\text{C} \leq T_J \leq 125^\circ\text{C}$ | | 20 | |
| | | LM4132B-3.3 | $-40^\circ\text{C} \leq T_J \leq 125^\circ\text{C}$ | | 20 | |
| | | | | | 20 | |
| | | | | | 20 | |
| LM4132E-3.3 | | 30 | | | | |
| I_Q | Supply current | $-40^\circ\text{C} \leq T_J \leq 125^\circ\text{C}$ | | 60 | | μA |
| | | | | 100 | | |
| I_{Q_SD} | Supply current in shutdown | $-40^\circ\text{C} \leq T_J \leq 125^\circ\text{C}$ | EN = 0 V | 3 | | μA |
| | | | | 7 | | |
| $\Delta V_{REF}/\Delta V_{IN}$ | Line regulation | $V_{REF} + 400\text{ mV} \leq V_{IN} \leq 5.5\text{ V}$ | | 85 | | ppm/V |
| $\Delta V_{REF}/\Delta I_{LOAD}$ | Load Regulation | $-40^\circ\text{C} \leq T_J \leq 125^\circ\text{C}$ | $0\text{ mA} \leq I_{LOAD} \leq 20\text{ mA}$ | 25 | | ppm/mA |
| | | | | 120 | | |
| ΔV_{REF} | Long-term stability ⁽³⁾ | 1000 Hrs | | 50 | | ppm |
| | Thermal hysteresis ⁽⁴⁾ | $-40^\circ\text{C} \leq T_J \leq 125^\circ\text{C}$ | | 75 | | |
| $V_{IN} - V_{REF}$ | Dropout voltage ⁽⁵⁾ | $-40^\circ\text{C} \leq T_J \leq 125^\circ\text{C}$ | $I_{LOAD} = 10\text{ mA}$ | 175 | | mV |
| | | | | 400 | | |
| V_N | Output noise voltage | 0.1 Hz to 10 Hz | | 310 | | μV_{PP} |
| I_{SC} | Short-circuit current | $-40^\circ\text{C} \leq T_J \leq 125^\circ\text{C}$ | | | 75 | mA |
| V_{IL} | Enable pin maximum low input level | $-40^\circ\text{C} \leq T_J \leq 125^\circ\text{C}$ | | | 35% (V_{IN}) | V |
| V_{IH} | Enable pin minimum high input level | $-40^\circ\text{C} \leq T_J \leq 125^\circ\text{C}$ | | | 65% (V_{IN}) | V |

- (1) Limits are 100% production tested at 25°C . Limits over the operating temperature range are specified through correlation using Statistical Quality Control.
- (2) Typical numbers are at 25°C and represent the most likely parametric norm.
- (3) Long-term stability is V_{REF} at 25°C measured during 1000 hrs.
- (4) Thermal hysteresis is defined as the change in 25°C output voltage before and after cycling the device from (-40°C to 125°C).
- (5) Dropout voltage is defined as the minimum input to output differential at which the output voltage drops by 0.5% below the value measured with a 5-V input.

6.10 Electrical Characteristics LM4132-3.3-Q1 ($V_{OUT} = 3.3\text{ V}$)

Unless otherwise specified, limits are $T_J = 25^\circ\text{C}$, $V_{IN} = 5\text{ V}$, and $I_{LOAD} = 0\text{ mA}$.

| PARAMETER | | TEST CONDITIONS | MIN ⁽¹⁾ | TYP ⁽²⁾ | MAX ⁽¹⁾ | UNIT |
|----------------------------------|-------------------------------------|---|---|--------------------|--------------------|-----------------------|
| V_{REF} | Output voltage initial accuracy | LM4132C-3.3-Q1 | (C Grade - 0.2%) | -0.2% | 0.2% | |
| | | LM4132D-3.3-Q1 | (D Grade - 0.4%) | -0.4% | 0.4% | |
| $TCV_{REF}/^\circ\text{C}$ | Temperature coefficient | LM4132C-3.3-Q1 | $-40^\circ\text{C} \leq T_J \leq 125^\circ\text{C}$ | | 20 | ppm/ $^\circ\text{C}$ |
| | | LM4132D-3.3-Q1 | | | 20 | |
| I_Q | Supply current | | | 60 | | μA |
| | | | $-40^\circ\text{C} \leq T_J \leq 125^\circ\text{C}$ | | 100 | |
| I_{Q_SD} | Supply current in shutdown | EN = 0 V | | 3 | | μA |
| | | | $-40^\circ\text{C} \leq T_J \leq 125^\circ\text{C}$ | | 7 | |
| $\Delta V_{REF}/\Delta V_{IN}$ | Line regulation | $V_{REF} + 400\text{ mV} \leq V_{IN} \leq 5.5\text{ V}$ | | 85 | | ppm/V |
| $\Delta V_{REF}/\Delta I_{LOAD}$ | Load Regulation | $0\text{ mA} \leq I_{LOAD} \leq 25\text{ mA}$ | | 25 | | ppm/mA |
| | | | $-40^\circ\text{C} \leq T_J \leq 125^\circ\text{C}$ | | 120 | |
| ΔV_{REF} | Long-term stability ⁽³⁾ | 1000 Hrs | | 50 | | ppm |
| | Thermal hysteresis ⁽⁴⁾ | $-40^\circ\text{C} \leq T_J \leq 125^\circ\text{C}$ | | 75 | | |
| $V_{IN} - V_{REF}$ | Dropout voltage ⁽⁵⁾ | $I_{LOAD} = 10\text{ mA}$ | | 175 | | mV |
| | | | $-40^\circ\text{C} \leq T_J \leq 125^\circ\text{C}$ | | 400 | |
| V_N | Output noise voltage | 0.1 Hz to 10 Hz | | 310 | | μV_{PP} |
| I_{SC} | Short-circuit current | $-40^\circ\text{C} \leq T_J \leq 125^\circ\text{C}$ | | | 75 | mA |
| V_{IL} | Enable pin maximum low input level | $-40^\circ\text{C} \leq T_J \leq 125^\circ\text{C}$ | | | 35% (V_{IN}) | V |
| V_{IH} | Enable pin minimum high input level | $-40^\circ\text{C} \leq T_J \leq 125^\circ\text{C}$ | | | 65% (V_{IN}) | V |

- (1) Limits are 100% production tested at 25°C . Limits over the operating temperature range are specified through correlation using Statistical Quality Control.
- (2) Typical numbers are at 25°C and represent the most likely parametric norm.
- (3) Long-term stability is V_{REF} at 25°C measured during 1000 hrs.
- (4) Thermal hysteresis is defined as the change in 25°C output voltage before and after cycling the device from (-40°C to 125°C).
- (5) Dropout voltage is defined as the minimum input to output differential at which the output voltage drops by 0.5% below the value measured with a 5-V input.

6.11 Electrical Characteristics LM4132-4.1 ($V_{OUT} = 4.096\text{ V}$)

Unless otherwise specified, limits are $T_J = 25^\circ\text{C}$, $V_{IN} = 5\text{ V}$, and $I_{LOAD} = 0\text{ mA}$.

| PARAMETER | | TEST CONDITIONS | MIN ⁽¹⁾ | TYP ⁽²⁾ | MAX ⁽¹⁾ | UNIT |
|----------------------------------|-------------------------------------|---|---|--------------------|--------------------|-----------------------|
| V_{REF} | Output voltage initial accuracy | LM4132A-4.1 | (A Grade - 0.05%) | -0.05% | 0.05% | |
| | | LM4132B-4.1 | (B Grade - 0.1%) | -0.1% | 0.1% | |
| | | LM4132C-4.1 | (C Grade - 0.2%) | -0.2% | 0.2% | |
| | | LM4132D-4.1 | (D Grade - 0.4%) | -0.4% | 0.4% | |
| | | LM4132E-4.1 | (E Grade - 0.5%) | -0.5% | 0.5% | |
| $TCV_{REF}/^\circ\text{C}$ | Temperature coefficient | LM4132A-4.1 | $0^\circ\text{C} \leq T_J \leq 85^\circ\text{C}$ | | 10 | ppm/ $^\circ\text{C}$ |
| | | | $-40^\circ\text{C} \leq T_J \leq 125^\circ\text{C}$ | | 20 | |
| | | LM4132B-4.1 | $-40^\circ\text{C} \leq T_J \leq 125^\circ\text{C}$ | | 20 | |
| | | LM4132C-4.1 | | | 20 | |
| | | LM4132D-4.1 | | | 20 | |
| LM4132E-4.1 | | 30 | | | | |
| I_Q | Supply current | $-40^\circ\text{C} \leq T_J \leq 125^\circ\text{C}$ | | 60 | | μA |
| | | | | 100 | | |
| I_{Q_SD} | Supply current in shutdown | EN = 0 V | | 3 | | μA |
| | | $-40^\circ\text{C} \leq T_J \leq 125^\circ\text{C}$ | | 7 | | |
| $\Delta V_{REF}/\Delta V_{IN}$ | Line regulation | $V_{REF} + 400\text{ mV} \leq V_{IN} \leq 5.5\text{ V}$ | | 100 | | ppm/V |
| $\Delta V_{REF}/\Delta I_{LOAD}$ | Load regulation | $0\text{ mA} \leq I_{LOAD} \leq 20\text{ mA}$ | | 25 | | ppm/mA |
| | | $-40^\circ\text{C} \leq T_J \leq 125^\circ\text{C}$ | | 120 | | |
| ΔV_{REF} | Long-term stability ⁽³⁾ | 1000 Hrs | | 50 | | ppm |
| | Thermal hysteresis ⁽⁴⁾ | $-40^\circ\text{C} \leq T_J \leq 125^\circ\text{C}$ | | 75 | | |
| $V_{IN} - V_{REF}$ | Dropout voltage ⁽⁵⁾ | $I_{LOAD} = 10\text{ mA}$ | | 175 | | mV |
| | | $-40^\circ\text{C} \leq T_J \leq 125^\circ\text{C}$ | | 400 | | |
| V_N | Output noise voltage | 0.1 Hz to 10 Hz | | 350 | | μV_{PP} |
| I_{SC} | Short-circuit current | $-40^\circ\text{C} \leq T_J \leq 125^\circ\text{C}$ | | | 75 | mA |
| V_{IL} | Enable pin maximum low input level | $-40^\circ\text{C} \leq T_J \leq 125^\circ\text{C}$ | | | 35% (V_{IN}) | V |
| V_{IH} | Enable pin minimum high input level | $-40^\circ\text{C} \leq T_J \leq 125^\circ\text{C}$ | | | 65% (V_{IN}) | V |

- (1) Limits are 100% production tested at 25°C . Limits over the operating temperature range are specified through correlation using Statistical Quality Control.
- (2) Typical numbers are at 25°C and represent the most likely parametric norm.
- (3) Long-term stability is V_{REF} at 25°C measured during 1000 hrs.
- (4) Thermal hysteresis is defined as the change in 25°C output voltage before and after cycling the device from (-40°C to 125°C).
- (5) Dropout voltage is defined as the minimum input to output differential at which the output voltage drops by 0.5% below the value measured with a 5-V input.

6.12 Typical Characteristics

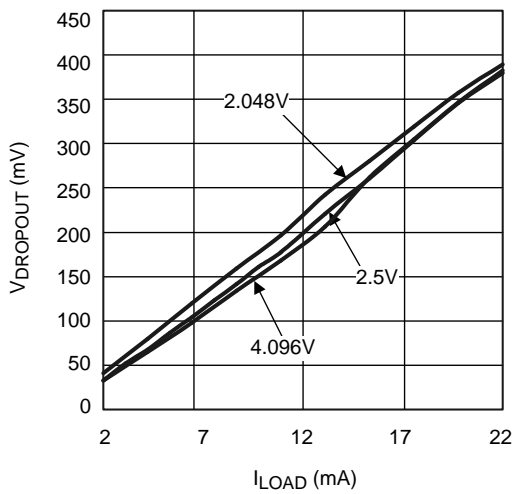

Figure 1. Dropout vs Load to 0.5% Accuracy



Figure 2. Supply Current vs Input Voltage

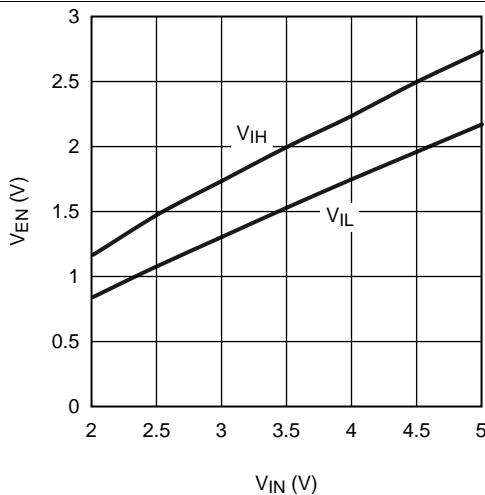

Figure 3. Enable Threshold Voltage and Hysteresis

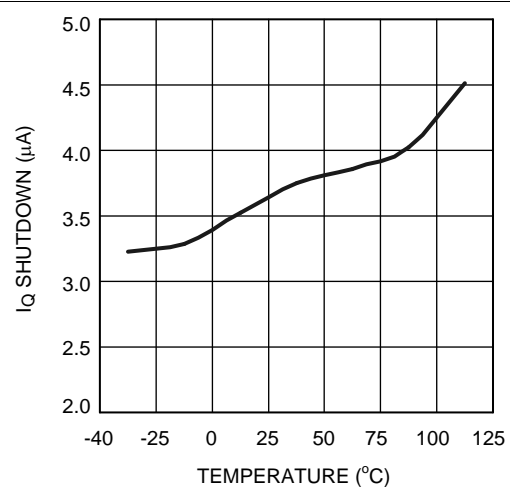

Figure 4. Shutdown I_Q vs Temperature

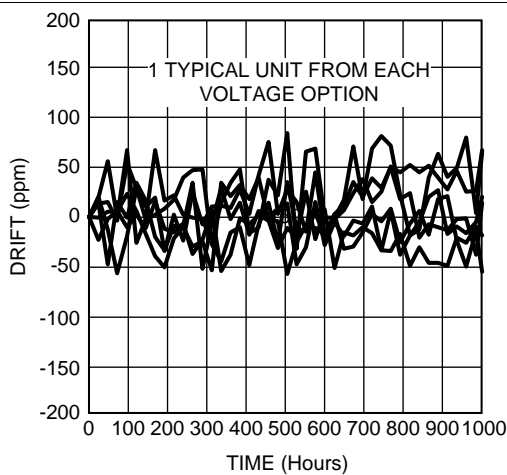

Figure 5. Typical Long-Term Stability

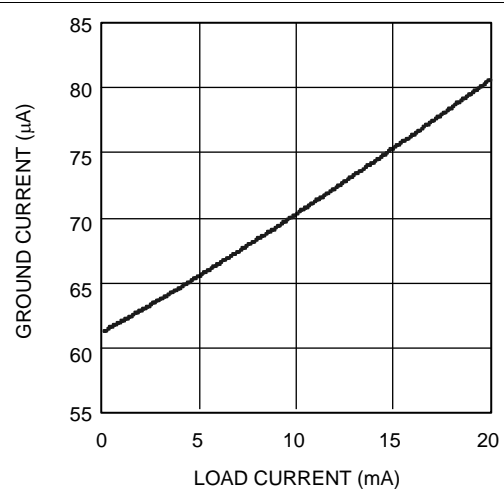

Figure 6. Ground Current vs Load Current

Typical Characteristics (continued)

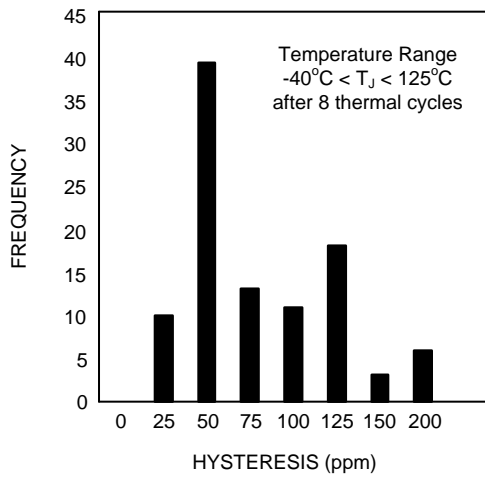

Figure 7. Typical Thermal Hysteresis

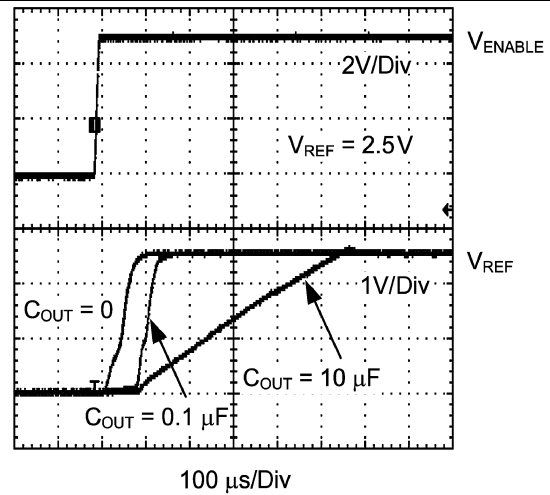

Figure 8. Turnon Transient Response

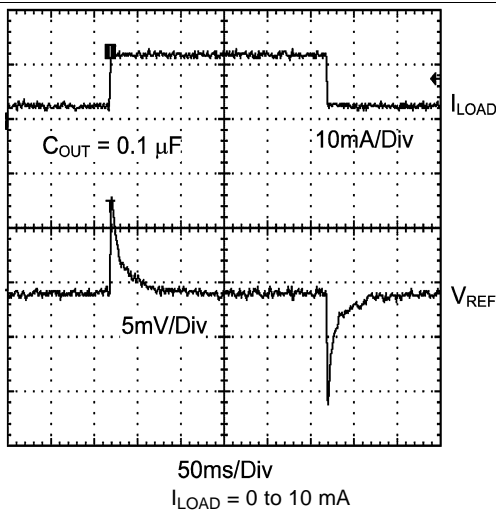

Figure 9. Load Transient Response



Figure 10. Line Transient Response

6.12.1 Typical Characteristics for 1.8 V



Figure 11. Output Voltage vs Temperature



Figure 12. Load Regulation

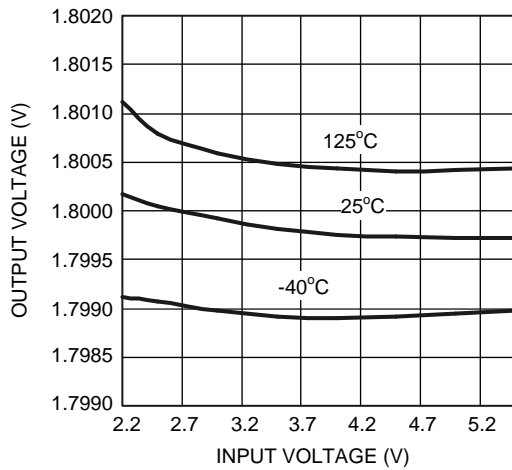

Figure 13. Line Regulation



Figure 14. 0.1–10 Hz Noise



Figure 15. Output Voltage Noise Spectrum



Figure 16. Power Supply Rejection vs Frequency

6.12.2 Typical Characteristics for 2.048 V



Figure 17. Output Voltage vs Temperature



Figure 18. Load Regulation



Figure 19. Line Regulation



Figure 20. 0.1–10 Hz Noise

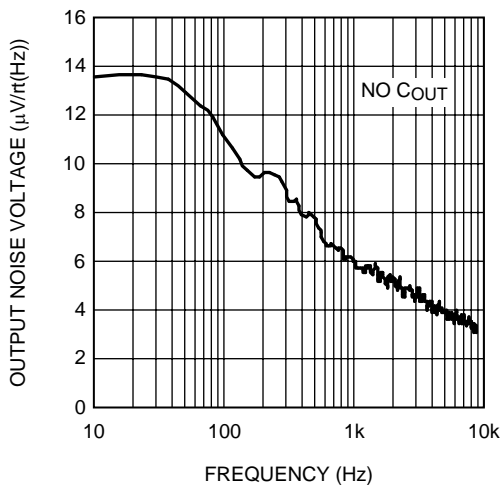

Figure 21. Output Voltage Noise Spectrum

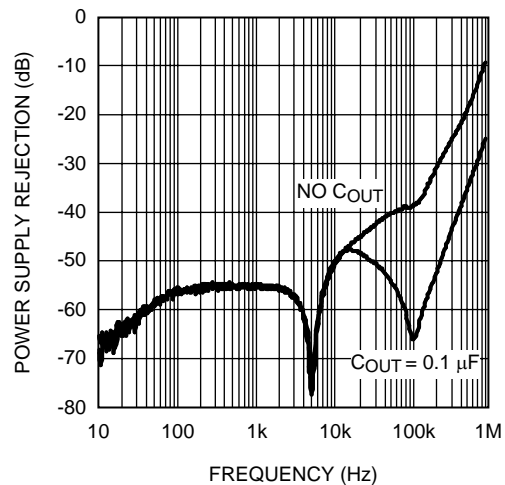

Figure 22. Power Supply Rejection vs Frequency

6.12.3 Typical Characteristics for 2.5 V

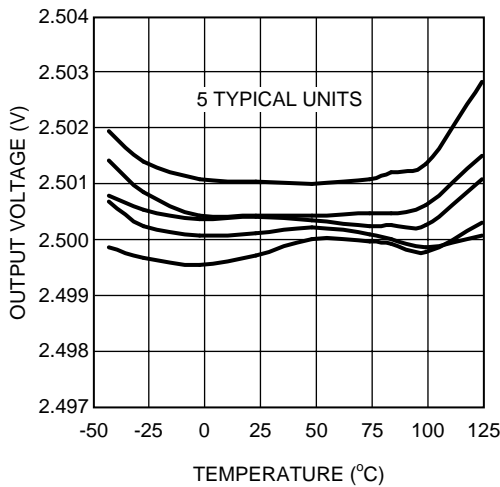

Figure 23. Output Voltage vs Temperature



Figure 24. Load Regulation

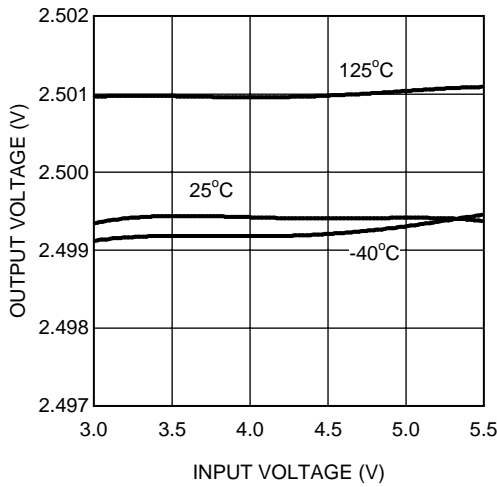

Figure 25. Line Regulation

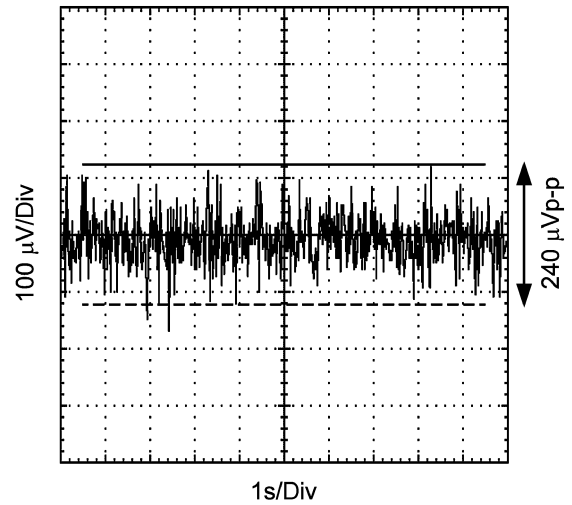

Figure 26. 0.1–10 Hz Noise

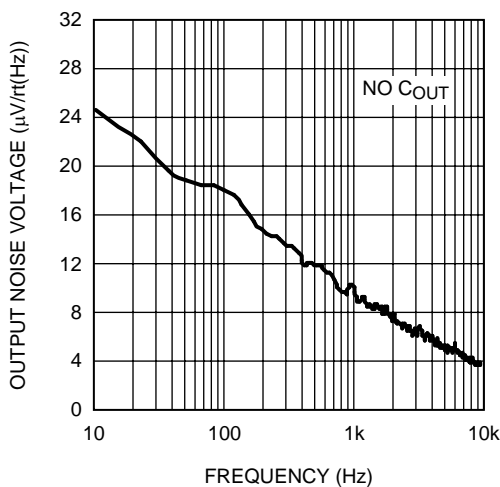

Figure 27. Output Voltage Noise Spectrum



Figure 28. Power Supply Rejection vs Frequency

6.12.4 Typical Characteristics for 3 V

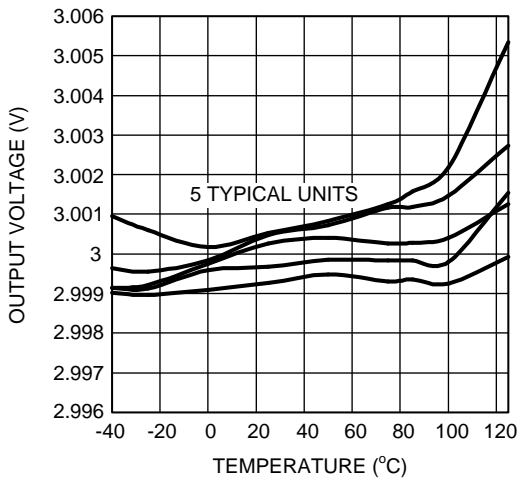

Figure 29. Output Voltage vs Temperature



Figure 30. Load Regulation

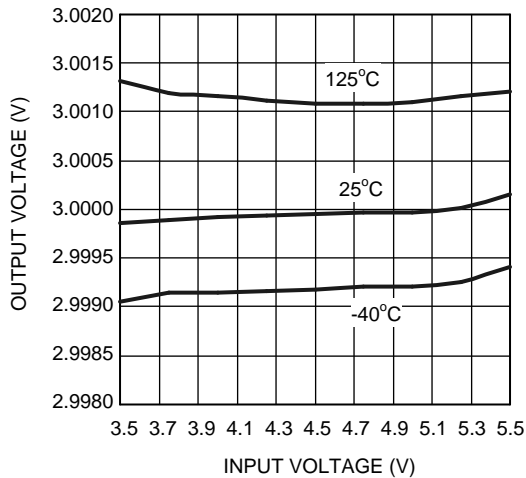

Figure 31. Line Regulation

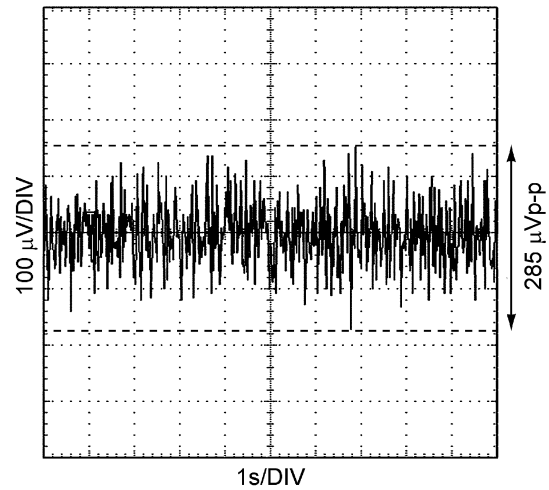

Figure 32. 0.1–10 Hz Noise

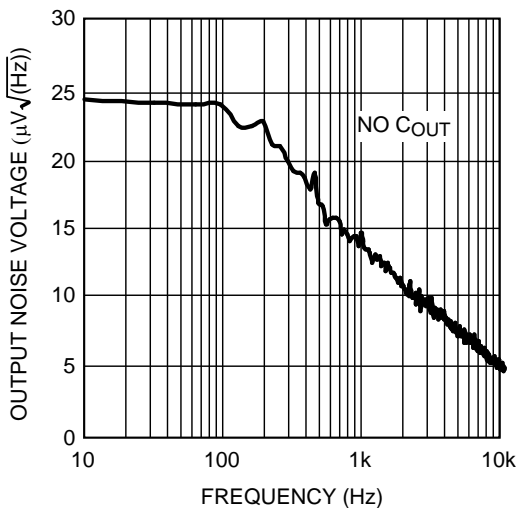

Figure 33. Output Voltage Noise Spectrum

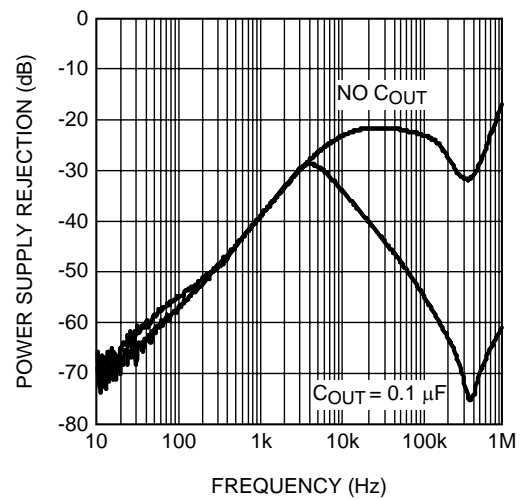

Figure 34. Power Supply Rejection vs Frequency

6.12.5 Typical Characteristics for 3.3 V



Figure 35. Output Voltage vs Temperature



Figure 36. Load Regulation



Figure 37. Line Regulation



Figure 38. 0.1–10 Hz Noise



Figure 39. Output Voltage Noise Spectrum



Figure 40. Power Supply Rejection vs Frequency

6.12.6 Typical Characteristics for 4.096 V

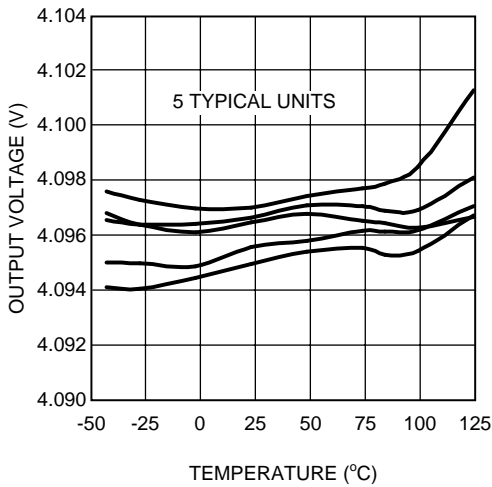

Figure 41. Output Voltage vs Temperature



Figure 42. Load Regulation

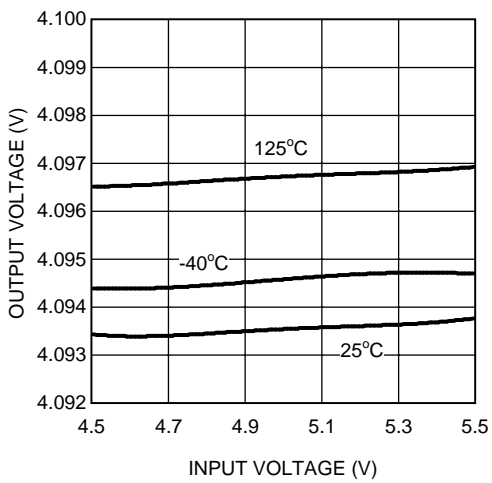

Figure 43. Line Regulation



Figure 44. 0.1–10 Hz Noise

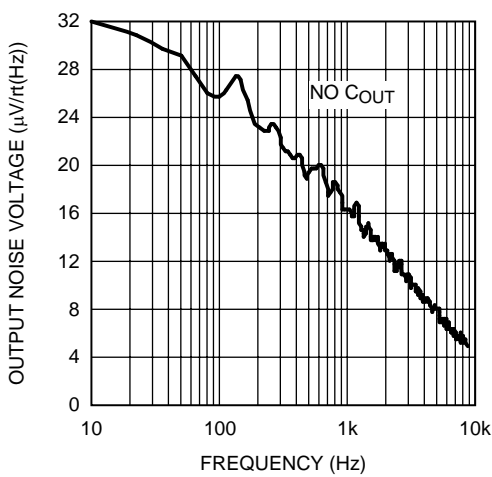

Figure 45. Output Voltage Noise Spectrum

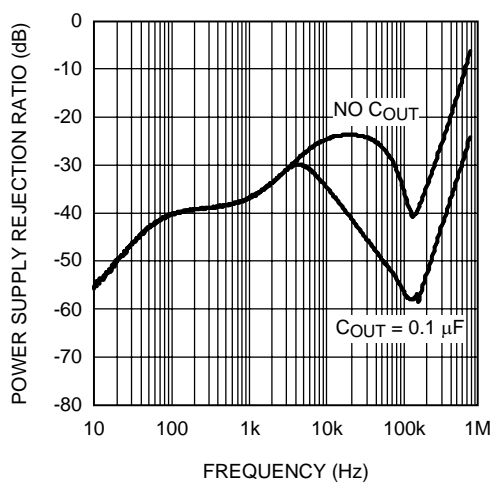

Figure 46. Power Supply Rejection vs Frequency

7 Detailed Description

7.1 Overview

The LM4132 device is a precision band-gap voltage reference available in 6 different voltages with 20-mA current source capability. This series reference can operate with input voltages from $V_{REF} + 400\text{ mV}$ to 5.5 V while consuming 60- μA (typical) supply current. In shutdown mode, current drops to 3 μA (typical). The LM4132 is available in five grades from A and E.

The best grade devices (A) have an initial accuracy of 0.05% with a specified tempco of 10 ppm/ $^{\circ}\text{C}$ from -40°C to 125°C . The grade devices (E) have an initial accuracy of 0.5% with specified tempco of 30 ppm/ $^{\circ}\text{C}$ from -40°C to 125°C .

7.2 Functional Block Diagram



7.3 Feature Description

The LM4132 can be remotely operated by applying an EN voltage between 65% of V_{IN} , and V_{IN} . The LM4312 can be remotely disabled by applying an EN voltage between 0 V to 35% of V_{IN} . The EN pin can also be strapped to V_{IN} , so V_{REF} is active when V_{IN} is applied.

7.3.1 Short Circuited Output

The LM4132 features indefinite short-circuit protection. This protection limits the output current to 75 mA when the output is shorted to ground.

7.3.2 Turnon Time

Turnon time is defined as the time taken for the output voltage to rise to 90% of the preset value. The turnon time depends on the load. The turnon time is typically 33.2 μs when driving a 1- μF load and 78.8 μs when driving a 10- μF load. Some users may experience an extended turnon time (up to 10 ms) under brownout conditions and low temperatures (-40°C).

Feature Description (continued)

7.3.3 Thermal Hysteresis

Thermal hysteresis is defined as the change in output voltage at 25°C after some deviation from 25°C. This is to say that thermal hysteresis is the difference in output voltage between two points in a given temperature profile. An illustrative temperature profile is shown in Figure 47.

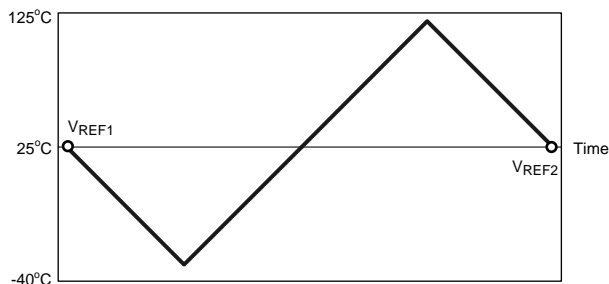

Figure 47. Temperature Profile

This may be expressed analytically by Equation 1:

$$V_{HYS} = \frac{|V_{REF1} - V_{REF2}|}{V_{REF}} \times 10^6 \text{ ppm}$$

where

- V_{HYS} = Thermal hysteresis expressed in ppm
- V_{REF} = Nominal preset output voltage
- V_{REF1} = V_{REF} before temperature fluctuation
- V_{REF2} = V_{REF} after temperature fluctuation
- The LM4132 features a low thermal hysteresis of 75 ppm (typical) from -40°C to 125°C after 8 temperature cycles. (1)

7.4 Device Functional Modes

Table 1 describes the functional modes of the LM4132.

Table 1. Enable Pin Mode Summary

| ENABLE PIN CONNECTION | LOGIC STATE | DESCRIPTION |
|-----------------------|-------------|--------------------------------------|
| EN = VIN | 1 | Normal operation — LM4132 starts up. |
| EN = GND | 0 | The LM4132 is in shutdown mode. |

8 Applications and Implementation

NOTE

Information in the following applications sections is not part of the TI component specification, and TI does not warrant its accuracy or completeness. TI's customers are responsible for determining suitability of components for their purposes. Customers should validate and test their design implementation to confirm system functionality.

8.1 Application Information

The LM4132 family of precision voltage references can deliver up to 20 mA without an output capacitor or buffer amplifier. The LM4132 is ideal for battery-powered solutions, with a low quiescent current of 60 μ A, and a low dropout voltage of 400 mV. The LM4132 enters the shutdown mode (3 μ A, typical) when EN is 0 V.

8.2 Typical Applications

8.2.1 LM4132 Typical Application



8.2.1.1 Design Requirements

For this design example, use the parameters listed as the input parameters.

- $V_{IN} > V_{REF} + 400 \text{ mV}$ ($I_{LOAD} \leq 10 \text{ mA}$)
- $I_{LOAD} \leq 20 \text{ mA}$
- The LM4132 is enabled when $65\%V_{IN} < V_{EN} \leq V_{IN}$. V_{EN} cannot be greater than V_{IN} ; otherwise, the device does not operate correctly.
- The device is disabled when $0 \text{ V} \leq V_{EN} \leq 35\% V_{IN}$.

8.2.1.2 Detailed Design Procedure

The foundation of any voltage reference is the band-gap circuit. While the reference in the LM4132 is developed from the gate-source voltage of transistors in the device, principles of the band-gap circuit are easily understood using a bipolar example. For a detailed analysis of the bipolar band-gap circuit, refer to [AN-56 LM113 1.2V Reference](#) (SNVA514).

8.2.1.2.1 Supply and Enable Voltages

To ensure proper operation, V_{EN} and V_{IN} must be within a specified range. An acceptable range of input voltages is calculated by [Equation 2](#):

$$V_{IN} > V_{REF} + 400 \text{ mV} \quad (I_{LOAD} \leq 10 \text{ mA}) \quad (2)$$

The EN pin uses an internal pullup current source ($I_{PULLUP} \approx 2 \mu\text{A}$) that may be left floating or triggered by an external source. If the device is not enabled by an external source, it may be connected to V_{IN} . An acceptable range of enable voltages is given by [Figure 4](#). See [Electrical Characteristics LM4132-1.8 \(V_{OUT} = 1.8 V\)](#) and [Figure 3](#) for more detail. The device does not operate correctly for $V_{EN} > V_{IN}$.

Typical Applications (continued)

8.2.1.2.2 Component Selection

A small ceramic (X5R or X7R) capacitor on the input must be used to ensure stable operation. The value of C_{IN} must be sized according to the output capacitor value. The value of C_{IN} must satisfy the relationship $C_{IN} \geq C_{OUT}$. When no output capacitor is used, C_{IN} must have a minimum value of 0.1 μF . Noise on the power-supply input may affect the output noise. Larger input capacitor values (typically 4.7 μF to 22 μF) may help reduce noise on the output and significantly reduce overshoot during start-up. Use of an additional optional bypass capacitor from the input and ground may help further reduce noise on the output. With an input capacitor, the LM4132 drives any combination of resistance and capacitance up to $V_{REF} / 20 \text{ mA}$ and 10 μF , respectively.

The LM4132 is designed to operate with or without an output capacitor and is stable with capacitive loads up to 10 μF . Connecting a capacitor from the output and ground significantly improves the load transient response when switching from a light load to a heavy load. The output capacitor must not be made arbitrarily large because capacitor selection affects the turnon time as well as line and load transients.

While a variety of capacitor chemistry types may be used, it is typically advisable to use low equivalent series resistance (ESR) ceramic capacitors. Such capacitors provide a low impedance to high frequency signals, effectively bypassing them to ground. Bypass capacitors must be mounted close to the device. Mounting bypass capacitors close to the device helps reduce the parasitic trace components thereby improving performance.

8.2.1.2.3 Temperature Coefficient

Temperature drift is defined as the maximum deviation in output voltage over the operating temperature range. This deviation over temperature may be shown in [Figure 48](#):

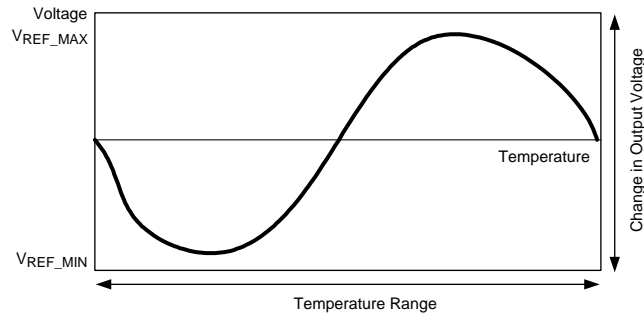

Figure 48. V_{REF} vs Temperature Profile

Temperature coefficient may be expressed analytically as [Equation 3](#):

$$T_D = \frac{(V_{REF_MAX} - V_{REF_MIN})}{V_{REF} \times \Delta T} \times 10^6 \text{ ppm}$$

where

- T_D = Temperature drift
- V_{REF} = Nominal preset output voltage
- V_{REF_MIN} = Minimum output voltage over operating temperature range
- V_{REF_MAX} = Maximum output voltage over operating temperature range
- ΔT = Operating temperature range
- The LM4132 features a low temperature drift of 10 ppm (maximum) to 30 ppm (maximum), depending on the grade. (3)

8.2.1.2.4 Long-Term Stability

Long-term stability refers to the fluctuation in output voltage over a long period of time (1000 hours). The LM4132 features a typical long-term stability of 50 ppm over 1000 hours. The measurements are made using 5 units of each voltage option, at a nominal input voltage (5 V), with no load, at room temperature.

Typical Applications (continued)

8.2.1.2.5 Expression of Electrical Characteristics

Electrical characteristics are typically expressed in mV, ppm, or a percentage of the nominal value. Depending on the application, one expression may be more useful than the other. To convert one quantity to the other one may apply the following:

ppm to mV error in output voltage:

$$\frac{V_{REF} \times \text{ppm}_{ERROR}}{10^3} = V_{ERROR}$$

where

- V_{REF} is in volts (V)
- V_{ERROR} is in millivolts (mV)

(4)

Bit error (1 bit) to voltage error (mV):

$$\frac{V_{REF}}{2^n} \times 10^3 = V_{ERROR}$$

where

- V_{REF} is in volts (V)
- V_{ERROR} is in millivolts (mV)
- n is the number of bits

(5)

mV to ppm error in output voltage:

$$\frac{V_{ERROR}}{V_{REF}} \times 10^3 = \text{ppm}_{ERROR}$$

where

- V_{REF} is in volts (V)
- V_{ERROR} is in millivolts (mV)

(6)

Voltage error (mV) to percentage error (percent):

$$\frac{V_{ERROR}}{V_{REF}} \times 0.1 = \text{Percent_Error}$$

where

- V_{REF} is in volts (V)
- V_{ERROR} is in millivolts (mV)

(7)

8.2.1.3 Application Curves

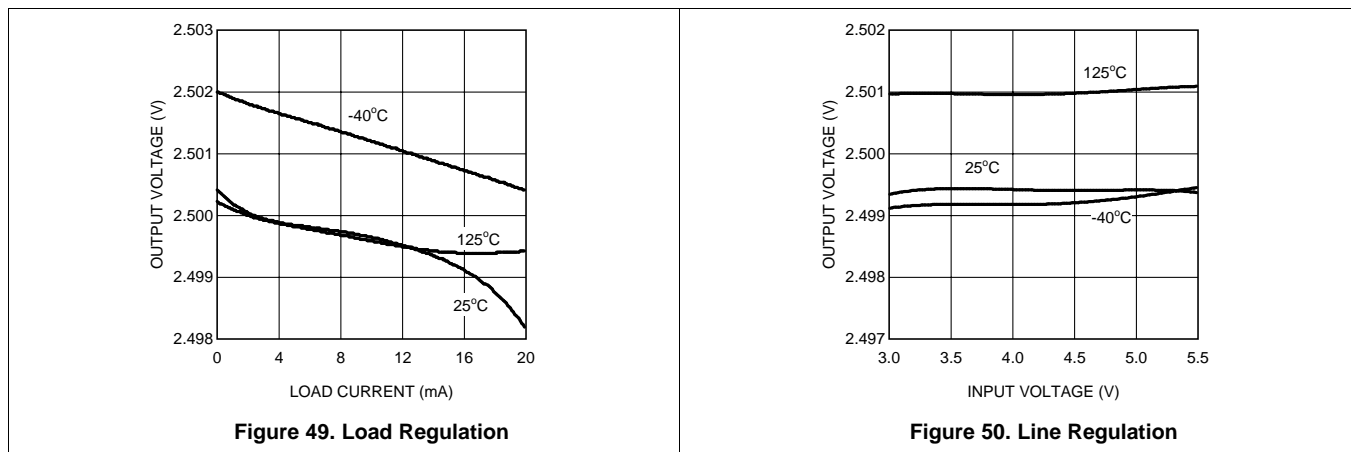

Typical Applications (continued)

8.2.2 Other Application Circuits



Figure 51. Voltage Reference With Complementary Output



Figure 52. Precision Voltage Reference With Force and Sense Output



Figure 53. Programmable Current Source

9 Power Supply Recommendations

An input capacitor between VIN and ground is required, and must be placed close to the device. An output capacitor is optional, and if used must satisfy the relationship $C_{IN} \geq C_{OUT}$. Refer to [Component Selection](#).

10 Layout

10.1 Layout Guidelines

The mechanical stress due to PCB mounting can cause the output voltage to shift from its initial value. The center of a PCB generally has the highest mechanical and thermal expansion stress. Mounting the device near the edges or the corners of the board where mechanical stress is at its minimum. References in SOT-23 packages are generally less prone to assembly stress than devices in small outline (SOIC) packages.

A mechanical isolation of the device by creating an island by cutting a U shape slot (U - SLOT) on the PCB while mounting the device helps in reducing the impact of the PCB stresses on the output voltage of the reference. This approach would also provide some thermal isolation from the rest of the circuit.

Figure 54 shows a recommended printed board layout for LM4132 along with an in-set diagram, which exhibits a slot cut on three sides of the reference device.

Bypass capacitors must be mounted close to the device. Mounting bypass capacitors close to the device reduces the parasitic trace components, thereby improving performance.

10.2 Layout Example



Figure 54. Typical Layout Example With LM4132

11 Device and Documentation Support

11.1 Documentation Support

11.1.1 Related Documentation

For related documentation see the following:

[AN-56 LM113 1.2V Reference](#) (SNVA514)

11.2 Related Links

The table below lists quick access links. Categories include technical documents, support and community resources, tools and software, and quick access to sample or buy.

Table 2. Related Links

| PARTS | PRODUCT FOLDER | SAMPLE & BUY | TECHNICAL DOCUMENTS | TOOLS & SOFTWARE | SUPPORT & COMMUNITY |
|-----------|----------------------------|----------------------------|----------------------------|----------------------------|----------------------------|
| LM4132 | Click here | Click here | Click here | Click here | Click here |
| LM4132-Q1 | Click here | Click here | Click here | Click here | Click here |

11.3 Receiving Notification of Documentation Updates

To receive notification of documentation updates, navigate to the device product folder on ti.com. In the upper right corner, click on *Alert me* to register and receive a weekly digest of any product information that has changed. For change details, review the revision history included in any revised document.

11.4 Community Resources

The following links connect to TI community resources. Linked contents are provided "AS IS" by the respective contributors. They do not constitute TI specifications and do not necessarily reflect TI's views; see TI's [Terms of Use](#).

TI E2E™ Online Community *TI's Engineer-to-Engineer (E2E) Community*. Created to foster collaboration among engineers. At e2e.ti.com, you can ask questions, share knowledge, explore ideas and help solve problems with fellow engineers.

Design Support *TI's Design Support* Quickly find helpful E2E forums along with design support tools and contact information for technical support.

11.5 Trademarks

E2E is a trademark of Texas Instruments.
All other trademarks are the property of their respective owners.

11.6 Electrostatic Discharge Caution



These devices have limited built-in ESD protection. The leads should be shorted together or the device placed in conductive foam during storage or handling to prevent electrostatic damage to the MOS gates.

11.7 Glossary

[SLYZ022](#) — *TI Glossary*.

This glossary lists and explains terms, acronyms, and definitions.

12 Mechanical, Packaging, and Orderable Information

The following pages include mechanical, packaging, and orderable information. This information is the most current data available for the designated devices. This data is subject to change without notice and revision of this document. For browser-based versions of this data sheet, refer to the left-hand navigation.

PACKAGING INFORMATION

| Orderable Device | Status (1) | Package Type | Package Drawing | Pins | Package Qty | Eco Plan (2) | Lead/Ball Finish (6) | MSL Peak Temp (3) | Op Temp (°C) | Device Marking (4/5) | Samples |
|---------------------|---------------|--------------|-----------------|------|-------------|-------------------------|-------------------------|----------------------|--------------|-------------------------|-------------------------|
| LM4132AMF-1.8/NOPB | ACTIVE | SOT-23 | DBV | 5 | 1000 | Green (RoHS & no Sb/Br) | CU SN | Level-1-260C-UNLIM | -40 to 125 | R4AA | Samples |
| LM4132AMF-2.0/NOPB | ACTIVE | SOT-23 | DBV | 5 | 1000 | Green (RoHS & no Sb/Br) | CU SN | Level-1-260C-UNLIM | -40 to 125 | R4BA | Samples |
| LM4132AMF-2.5/NOPB | ACTIVE | SOT-23 | DBV | 5 | 1000 | Green (RoHS & no Sb/Br) | CU SN | Level-1-260C-UNLIM | -40 to 125 | R4CA | Samples |
| LM4132AMF-3.0/NOPB | ACTIVE | SOT-23 | DBV | 5 | 1000 | Green (RoHS & no Sb/Br) | CU SN | Level-1-260C-UNLIM | -40 to 125 | R4DA | Samples |
| LM4132AMF-3.3/NOPB | ACTIVE | SOT-23 | DBV | 5 | 1000 | Green (RoHS & no Sb/Br) | CU SN | Level-1-260C-UNLIM | -40 to 125 | R4EA | Samples |
| LM4132AMF-4.1/NOPB | ACTIVE | SOT-23 | DBV | 5 | 1000 | Green (RoHS & no Sb/Br) | CU SN | Level-1-260C-UNLIM | -40 to 125 | R4FA | Samples |
| LM4132AMFX-1.8/NOPB | ACTIVE | SOT-23 | DBV | 5 | 3000 | Green (RoHS & no Sb/Br) | CU SN | Level-1-260C-UNLIM | -40 to 125 | R4AA | Samples |
| LM4132AMFX-2.0/NOPB | ACTIVE | SOT-23 | DBV | 5 | 3000 | Green (RoHS & no Sb/Br) | CU SN | Level-1-260C-UNLIM | -40 to 125 | R4BA | Samples |
| LM4132AMFX-2.5/NOPB | ACTIVE | SOT-23 | DBV | 5 | 3000 | Green (RoHS & no Sb/Br) | CU SN | Level-1-260C-UNLIM | -40 to 125 | R4CA | Samples |
| LM4132AMFX-3.0/NOPB | ACTIVE | SOT-23 | DBV | 5 | 3000 | Green (RoHS & no Sb/Br) | CU SN | Level-1-260C-UNLIM | -40 to 125 | R4DA | Samples |
| LM4132AMFX-3.3/NOPB | ACTIVE | SOT-23 | DBV | 5 | 3000 | Green (RoHS & no Sb/Br) | CU SN | Level-1-260C-UNLIM | -40 to 125 | R4EA | Samples |
| LM4132AMFX-4.1/NOPB | ACTIVE | SOT-23 | DBV | 5 | 3000 | Green (RoHS & no Sb/Br) | CU SN | Level-1-260C-UNLIM | -40 to 125 | R4FA | Samples |
| LM4132AQ1MFR2.5 | ACTIVE | SOT-23 | DBV | 5 | 3000 | Green (RoHS & no Sb/Br) | CU SN | Level-1-260C-UNLIM | -40 to 125 | ZECX | Samples |
| LM4132AQ1MFR3.0 | ACTIVE | SOT-23 | DBV | 5 | 3000 | Green (RoHS & no Sb/Br) | CU SN | Level-1-260C-UNLIM | -40 to 125 | ZEIX | Samples |
| LM4132AQ1MFT2.5 | ACTIVE | SOT-23 | DBV | 5 | 250 | Green (RoHS & no Sb/Br) | CU SN | Level-1-260C-UNLIM | -40 to 125 | ZECX | Samples |
| LM4132AQ1MFT3.0 | ACTIVE | SOT-23 | DBV | 5 | 250 | Green (RoHS & no Sb/Br) | CU SN | Level-1-260C-UNLIM | -40 to 125 | ZEIX | Samples |
| LM4132BMF-1.8/NOPB | ACTIVE | SOT-23 | DBV | 5 | 1000 | Green (RoHS & no Sb/Br) | CU SN | Level-1-260C-UNLIM | -40 to 125 | R4AB | Samples |

| Orderable Device | Status (1) | Package Type | Package Drawing | Pins | Package Qty | Eco Plan (2) | Lead/Ball Finish (6) | MSL Peak Temp (3) | Op Temp (°C) | Device Marking (4/5) | Samples |
|---------------------|---------------|--------------|-----------------|------|-------------|-------------------------|-------------------------|----------------------|--------------|-------------------------|-------------------------|
| LM4132BMF-2.0/NOPB | ACTIVE | SOT-23 | DBV | 5 | 1000 | Green (RoHS & no Sb/Br) | CU SN | Level-1-260C-UNLIM | -40 to 125 | R4BB | Samples |
| LM4132BMF-2.5/NOPB | ACTIVE | SOT-23 | DBV | 5 | 1000 | Green (RoHS & no Sb/Br) | CU SN | Level-1-260C-UNLIM | -40 to 125 | R4CB | Samples |
| LM4132BMF-3.0/NOPB | ACTIVE | SOT-23 | DBV | 5 | 1000 | Green (RoHS & no Sb/Br) | CU SN | Level-1-260C-UNLIM | -40 to 125 | R4DB | Samples |
| LM4132BMF-3.3/NOPB | ACTIVE | SOT-23 | DBV | 5 | 1000 | Green (RoHS & no Sb/Br) | CU SN | Level-1-260C-UNLIM | -40 to 125 | R4EB | Samples |
| LM4132BMF-4.1/NOPB | ACTIVE | SOT-23 | DBV | 5 | 1000 | Green (RoHS & no Sb/Br) | CU SN | Level-1-260C-UNLIM | -40 to 125 | R4FB | Samples |
| LM4132BMFX-1.8/NOPB | ACTIVE | SOT-23 | DBV | 5 | 3000 | Green (RoHS & no Sb/Br) | CU SN | Level-1-260C-UNLIM | -40 to 125 | R4AB | Samples |
| LM4132BMFX-2.0/NOPB | ACTIVE | SOT-23 | DBV | 5 | 3000 | Green (RoHS & no Sb/Br) | CU SN | Level-1-260C-UNLIM | -40 to 125 | R4BB | Samples |
| LM4132BMFX-2.5/NOPB | ACTIVE | SOT-23 | DBV | 5 | 3000 | Green (RoHS & no Sb/Br) | CU SN | Level-1-260C-UNLIM | -40 to 125 | R4CB | Samples |
| LM4132BMFX-3.0/NOPB | ACTIVE | SOT-23 | DBV | 5 | 3000 | Green (RoHS & no Sb/Br) | CU SN | Level-1-260C-UNLIM | -40 to 125 | R4DB | Samples |
| LM4132BMFX-3.3/NOPB | ACTIVE | SOT-23 | DBV | 5 | 3000 | Green (RoHS & no Sb/Br) | CU SN | Level-1-260C-UNLIM | -40 to 125 | R4EB | Samples |
| LM4132BMFX-4.1/NOPB | ACTIVE | SOT-23 | DBV | 5 | 3000 | Green (RoHS & no Sb/Br) | CU SN | Level-1-260C-UNLIM | -40 to 125 | R4FB | Samples |
| LM4132BQ1MFR2.5 | ACTIVE | SOT-23 | DBV | 5 | 3000 | Green (RoHS & no Sb/Br) | CU SN | Level-1-260C-UNLIM | -40 to 125 | ZDYX | Samples |
| LM4132BQ1MFR3.0 | ACTIVE | SOT-23 | DBV | 5 | 3000 | Green (RoHS & no Sb/Br) | CU SN | Level-1-260C-UNLIM | -40 to 125 | ZEJX | Samples |
| LM4132BQ1MFT2.5 | ACTIVE | SOT-23 | DBV | 5 | 250 | Green (RoHS & no Sb/Br) | CU SN | Level-1-260C-UNLIM | -40 to 125 | ZDYX | Samples |
| LM4132BQ1MFT3.0 | ACTIVE | SOT-23 | DBV | 5 | 250 | Green (RoHS & no Sb/Br) | CU SN | Level-1-260C-UNLIM | -40 to 125 | ZEJX | Samples |
| LM4132CMF-1.8/NOPB | ACTIVE | SOT-23 | DBV | 5 | 1000 | Green (RoHS & no Sb/Br) | CU SN | Level-1-260C-UNLIM | -40 to 125 | R4AC | Samples |
| LM4132CMF-2.0/NOPB | ACTIVE | SOT-23 | DBV | 5 | 1000 | Green (RoHS & no Sb/Br) | CU SN | Level-1-260C-UNLIM | -40 to 125 | R4BC | Samples |
| LM4132CMF-2.5/NOPB | ACTIVE | SOT-23 | DBV | 5 | 1000 | Green (RoHS & no Sb/Br) | CU SN | Level-1-260C-UNLIM | -40 to 125 | R4CC | Samples |

| Orderable Device | Status (1) | Package Type | Package Drawing | Pins | Package Qty | Eco Plan (2) | Lead/Ball Finish (6) | MSL Peak Temp (3) | Op Temp (°C) | Device Marking (4/5) | Samples |
|---------------------|---------------|--------------|-----------------|------|-------------|-------------------------|-------------------------|----------------------|--------------|-------------------------|-------------------------|
| LM4132CMF-3.0/NOPB | ACTIVE | SOT-23 | DBV | 5 | 1000 | Green (RoHS & no Sb/Br) | CU SN | Level-1-260C-UNLIM | -40 to 125 | R4DC | Samples |
| LM4132CMF-3.3/NOPB | ACTIVE | SOT-23 | DBV | 5 | 1000 | Green (RoHS & no Sb/Br) | CU SN | Level-1-260C-UNLIM | -40 to 125 | R4EC | Samples |
| LM4132CMF-4.1/NOPB | ACTIVE | SOT-23 | DBV | 5 | 1000 | Green (RoHS & no Sb/Br) | CU SN | Level-1-260C-UNLIM | -40 to 125 | R4FC | Samples |
| LM4132CMFX-1.8/NOPB | ACTIVE | SOT-23 | DBV | 5 | 3000 | Green (RoHS & no Sb/Br) | CU SN | Level-1-260C-UNLIM | -40 to 125 | R4AC | Samples |
| LM4132CMFX-2.0/NOPB | ACTIVE | SOT-23 | DBV | 5 | 3000 | Green (RoHS & no Sb/Br) | CU SN | Level-1-260C-UNLIM | -40 to 125 | R4BC | Samples |
| LM4132CMFX-2.5/NOPB | ACTIVE | SOT-23 | DBV | 5 | 3000 | Green (RoHS & no Sb/Br) | CU SN | Level-1-260C-UNLIM | -40 to 125 | R4CC | Samples |
| LM4132CMFX-3.0/NOPB | ACTIVE | SOT-23 | DBV | 5 | 3000 | Green (RoHS & no Sb/Br) | CU SN | Level-1-260C-UNLIM | -40 to 125 | R4DC | Samples |
| LM4132CMFX-3.3/NOPB | ACTIVE | SOT-23 | DBV | 5 | 3000 | Green (RoHS & no Sb/Br) | CU SN | Level-1-260C-UNLIM | -40 to 125 | R4EC | Samples |
| LM4132CMFX-4.1/NOPB | ACTIVE | SOT-23 | DBV | 5 | 3000 | Green (RoHS & no Sb/Br) | CU SN | Level-1-260C-UNLIM | -40 to 125 | R4FC | Samples |
| LM4132CQ1MFR2.5 | ACTIVE | SOT-23 | DBV | 5 | 3000 | Green (RoHS & no Sb/Br) | CU SN | Level-1-260C-UNLIM | -40 to 125 | ZDZX | Samples |
| LM4132CQ1MFR3.0 | ACTIVE | SOT-23 | DBV | 5 | 3000 | Green (RoHS & no Sb/Br) | CU SN | Level-1-260C-UNLIM | -40 to 125 | ZEKX | Samples |
| LM4132CQ1MFR3.3 | ACTIVE | SOT-23 | DBV | 5 | 3000 | Green (RoHS & no Sb/Br) | CU SN | Level-1-260C-UNLIM | -40 to 125 | ZEZX | Samples |
| LM4132CQ1MFT2.5 | ACTIVE | SOT-23 | DBV | 5 | 250 | Green (RoHS & no Sb/Br) | CU SN | Level-1-260C-UNLIM | -40 to 125 | ZDZX | Samples |
| LM4132CQ1MFT3.0 | ACTIVE | SOT-23 | DBV | 5 | 250 | Green (RoHS & no Sb/Br) | CU SN | Level-1-260C-UNLIM | -40 to 125 | ZEKX | Samples |
| LM4132CQ1MFT3.3 | ACTIVE | SOT-23 | DBV | 5 | 250 | Green (RoHS & no Sb/Br) | CU SN | Level-1-260C-UNLIM | -40 to 125 | ZEZX | Samples |
| LM4132DMF-1.8/NOPB | ACTIVE | SOT-23 | DBV | 5 | 1000 | Green (RoHS & no Sb/Br) | CU SN | Level-1-260C-UNLIM | -40 to 125 | R4AD | Samples |
| LM4132DMF-2.0/NOPB | ACTIVE | SOT-23 | DBV | 5 | 1000 | Green (RoHS & no Sb/Br) | CU SN | Level-1-260C-UNLIM | -40 to 125 | R4BD | Samples |
| LM4132DMF-2.5/NOPB | ACTIVE | SOT-23 | DBV | 5 | 1000 | Green (RoHS & no Sb/Br) | CU SN | Level-1-260C-UNLIM | -40 to 125 | R4CD | Samples |

| Orderable Device | Status (1) | Package Type | Package Drawing | Pins | Package Qty | Eco Plan (2) | Lead/Ball Finish (6) | MSL Peak Temp (3) | Op Temp (°C) | Device Marking (4/5) | Samples |
|---------------------|---------------|--------------|-----------------|------|-------------|-------------------------|-------------------------|----------------------|--------------|-------------------------|-------------------------|
| LM4132DMF-3.0/NOPB | ACTIVE | SOT-23 | DBV | 5 | 1000 | Green (RoHS & no Sb/Br) | CU SN | Level-1-260C-UNLIM | -40 to 125 | R4DD | Samples |
| LM4132DMF-3.3/NOPB | ACTIVE | SOT-23 | DBV | 5 | 1000 | Green (RoHS & no Sb/Br) | CU SN | Level-1-260C-UNLIM | -40 to 125 | R4ED | Samples |
| LM4132DMF-4.1/NOPB | ACTIVE | SOT-23 | DBV | 5 | 1000 | Green (RoHS & no Sb/Br) | CU SN | Level-1-260C-UNLIM | -40 to 125 | R4FD | Samples |
| LM4132DMFX-1.8/NOPB | ACTIVE | SOT-23 | DBV | 5 | 3000 | Green (RoHS & no Sb/Br) | CU SN | Level-1-260C-UNLIM | -40 to 125 | R4AD | Samples |
| LM4132DMFX-2.0/NOPB | ACTIVE | SOT-23 | DBV | 5 | 3000 | Green (RoHS & no Sb/Br) | CU SN | Level-1-260C-UNLIM | -40 to 125 | R4BD | Samples |
| LM4132DMFX-2.5/NOPB | ACTIVE | SOT-23 | DBV | 5 | 3000 | Green (RoHS & no Sb/Br) | CU SN | Level-1-260C-UNLIM | -40 to 125 | R4CD | Samples |
| LM4132DMFX-3.0/NOPB | ACTIVE | SOT-23 | DBV | 5 | 3000 | Green (RoHS & no Sb/Br) | CU SN | Level-1-260C-UNLIM | -40 to 125 | R4DD | Samples |
| LM4132DMFX-3.3/NOPB | ACTIVE | SOT-23 | DBV | 5 | 3000 | Green (RoHS & no Sb/Br) | CU SN | Level-1-260C-UNLIM | -40 to 125 | R4ED | Samples |
| LM4132DMFX-4.1/NOPB | ACTIVE | SOT-23 | DBV | 5 | 3000 | Green (RoHS & no Sb/Br) | CU SN | Level-1-260C-UNLIM | -40 to 125 | R4FD | Samples |
| LM4132DQ1MFR2.5 | ACTIVE | SOT-23 | DBV | 5 | 3000 | Green (RoHS & no Sb/Br) | CU SN | Level-1-260C-UNLIM | -40 to 125 | ZEAX | Samples |
| LM4132DQ1MFR3.0 | ACTIVE | SOT-23 | DBV | 5 | 3000 | Green (RoHS & no Sb/Br) | CU SN | Level-1-260C-UNLIM | -40 to 125 | ZELX | Samples |
| LM4132DQ1MFR3.3 | ACTIVE | SOT-23 | DBV | 5 | 3000 | Green (RoHS & no Sb/Br) | CU SN | Level-1-260C-UNLIM | -40 to 125 | ZFAX | Samples |
| LM4132DQ1MFT2.5 | ACTIVE | SOT-23 | DBV | 5 | 250 | Green (RoHS & no Sb/Br) | CU SN | Level-1-260C-UNLIM | -40 to 125 | ZEAX | Samples |
| LM4132DQ1MFT3.0 | ACTIVE | SOT-23 | DBV | 5 | 250 | Green (RoHS & no Sb/Br) | CU SN | Level-1-260C-UNLIM | -40 to 125 | ZELX | Samples |
| LM4132DQ1MFT3.3 | ACTIVE | SOT-23 | DBV | 5 | 250 | Green (RoHS & no Sb/Br) | CU SN | Level-1-260C-UNLIM | -40 to 125 | ZFAX | Samples |
| LM4132EMF-1.8/NOPB | ACTIVE | SOT-23 | DBV | 5 | 1000 | Green (RoHS & no Sb/Br) | CU SN | Level-1-260C-UNLIM | -40 to 125 | R4AE | Samples |
| LM4132EMF-2.0/NOPB | ACTIVE | SOT-23 | DBV | 5 | 1000 | Green (RoHS & no Sb/Br) | CU SN | Level-1-260C-UNLIM | -40 to 125 | R4BE | Samples |
| LM4132EMF-2.5/NOPB | ACTIVE | SOT-23 | DBV | 5 | 1000 | Green (RoHS & no Sb/Br) | CU SN | Level-1-260C-UNLIM | -40 to 125 | R4CE | Samples |

| Orderable Device | Status (1) | Package Type | Package Drawing | Pins | Package Qty | Eco Plan (2) | Lead/Ball Finish (6) | MSL Peak Temp (3) | Op Temp (°C) | Device Marking (4/5) | Samples |
|---------------------|---------------|--------------|-----------------|------|-------------|-------------------------|-------------------------|----------------------|--------------|-------------------------|-------------------------|
| LM4132EMF-3.0/NOPB | ACTIVE | SOT-23 | DBV | 5 | 1000 | Green (RoHS & no Sb/Br) | CU SN | Level-1-260C-UNLIM | -40 to 125 | R4DE | Samples |
| LM4132EMF-3.3/NOPB | ACTIVE | SOT-23 | DBV | 5 | 1000 | Green (RoHS & no Sb/Br) | CU SN | Level-1-260C-UNLIM | -40 to 125 | R4EE | Samples |
| LM4132EMF-4.1/NOPB | ACTIVE | SOT-23 | DBV | 5 | 1000 | Green (RoHS & no Sb/Br) | CU SN | Level-1-260C-UNLIM | -40 to 125 | R4FE | Samples |
| LM4132EMFX-1.8/NOPB | ACTIVE | SOT-23 | DBV | 5 | 3000 | Green (RoHS & no Sb/Br) | CU SN | Level-1-260C-UNLIM | -40 to 125 | R4AE | Samples |
| LM4132EMFX-2.0/NOPB | ACTIVE | SOT-23 | DBV | 5 | 3000 | Green (RoHS & no Sb/Br) | CU SN | Level-1-260C-UNLIM | -40 to 125 | R4BE | Samples |
| LM4132EMFX-2.5/NOPB | ACTIVE | SOT-23 | DBV | 5 | 3000 | Green (RoHS & no Sb/Br) | CU SN | Level-1-260C-UNLIM | -40 to 125 | R4CE | Samples |
| LM4132EMFX-3.0/NOPB | ACTIVE | SOT-23 | DBV | 5 | 3000 | Green (RoHS & no Sb/Br) | CU SN | Level-1-260C-UNLIM | -40 to 125 | R4DE | Samples |
| LM4132EMFX-3.3/NOPB | ACTIVE | SOT-23 | DBV | 5 | 3000 | Green (RoHS & no Sb/Br) | CU SN | Level-1-260C-UNLIM | -40 to 125 | R4EE | Samples |
| LM4132EMFX-4.1/NOPB | ACTIVE | SOT-23 | DBV | 5 | 3000 | Green (RoHS & no Sb/Br) | CU SN | Level-1-260C-UNLIM | -40 to 125 | R4FE | Samples |

(1) The marketing status values are defined as follows:

ACTIVE: Product device recommended for new designs.

LIFEBUY: TI has announced that the device will be discontinued, and a lifetime-buy period is in effect.

NRND: Not recommended for new designs. Device is in production to support existing customers, but TI does not recommend using this part in a new design.

PREVIEW: Device has been announced but is not in production. Samples may or may not be available.

OBSELETE: TI has discontinued the production of the device.

(2) **RoHS:** TI defines "RoHS" to mean semiconductor products that are compliant with the current EU RoHS requirements for all 10 RoHS substances, including the requirement that RoHS substance do not exceed 0.1% by weight in homogeneous materials. Where designed to be soldered at high temperatures, "RoHS" products are suitable for use in specified lead-free processes. TI may reference these types of products as "Pb-Free".

RoHS Exempt: TI defines "RoHS Exempt" to mean products that contain lead but are compliant with EU RoHS pursuant to a specific EU RoHS exemption.

Green: TI defines "Green" to mean the content of Chlorine (Cl) and Bromine (Br) based flame retardants meet JS709B low halogen requirements of <=1000ppm threshold. Antimony trioxide based flame retardants must also meet the <=1000ppm threshold requirement.

(3) MSL, Peak Temp. - The Moisture Sensitivity Level rating according to the JEDEC industry standard classifications, and peak solder temperature.

(4) There may be additional marking, which relates to the logo, the lot trace code information, or the environmental category on the device.

(5) Multiple Device Markings will be inside parentheses. Only one Device Marking contained in parentheses and separated by a "-" will appear on a device. If a line is indented then it is a continuation of the previous line and the two combined represent the entire Device Marking for that device.

(6) Lead/Ball Finish - Orderable Devices may have multiple material finish options. Finish options are separated by a vertical ruled line. Lead/Ball Finish values may wrap to two lines if the finish value exceeds the maximum column width.

Important Information and Disclaimer:The information provided on this page represents TI's knowledge and belief as of the date that it is provided. TI bases its knowledge and belief on information provided by third parties, and makes no representation or warranty as to the accuracy of such information. Efforts are underway to better integrate information from third parties. TI has taken and continues to take reasonable steps to provide representative and accurate information but may not have conducted destructive testing or chemical analysis on incoming materials and chemicals. TI and TI suppliers consider certain information to be proprietary, and thus CAS numbers and other limited information may not be available for release.

In no event shall TI's liability arising out of such information exceed the total purchase price of the TI part(s) at issue in this document sold by TI to Customer on an annual basis.

OTHER QUALIFIED VERSIONS OF LM4132, LM4132-Q1 :

- Catalog: [LM4132](#)

- Automotive: [LM4132-Q1](#)

NOTE: Qualified Version Definitions:

- Catalog - TI's standard catalog product

- Automotive - Q100 devices qualified for high-reliability automotive applications targeting zero defects

TAPE AND REEL INFORMATION

QUADRANT ASSIGNMENTS FOR PIN 1 ORIENTATION IN TAPE

*All dimensions are nominal

| Device | Package Type | Package Drawing | Pins | SPQ | Reel Diameter (mm) | Reel Width W1 (mm) | A0 (mm) | B0 (mm) | K0 (mm) | P1 (mm) | W (mm) | Pin1 Quadrant |
|---------------------|--------------|-----------------|------|------|--------------------|--------------------|---------|---------|---------|---------|--------|---------------|
| LM4132AMF-1.8/NOPB | SOT-23 | DBV | 5 | 1000 | 178.0 | 8.4 | 3.2 | 3.2 | 1.4 | 4.0 | 8.0 | Q3 |
| LM4132AMF-2.0/NOPB | SOT-23 | DBV | 5 | 1000 | 178.0 | 8.4 | 3.2 | 3.2 | 1.4 | 4.0 | 8.0 | Q3 |
| LM4132AMF-2.5/NOPB | SOT-23 | DBV | 5 | 1000 | 178.0 | 8.4 | 3.2 | 3.2 | 1.4 | 4.0 | 8.0 | Q3 |
| LM4132AMF-3.0/NOPB | SOT-23 | DBV | 5 | 1000 | 178.0 | 8.4 | 3.2 | 3.2 | 1.4 | 4.0 | 8.0 | Q3 |
| LM4132AMF-3.3/NOPB | SOT-23 | DBV | 5 | 1000 | 178.0 | 8.4 | 3.2 | 3.2 | 1.4 | 4.0 | 8.0 | Q3 |
| LM4132AMF-4.1/NOPB | SOT-23 | DBV | 5 | 1000 | 178.0 | 8.4 | 3.2 | 3.2 | 1.4 | 4.0 | 8.0 | Q3 |
| LM4132AMFX-1.8/NOPB | SOT-23 | DBV | 5 | 3000 | 178.0 | 8.4 | 3.2 | 3.2 | 1.4 | 4.0 | 8.0 | Q3 |
| LM4132AMFX-2.0/NOPB | SOT-23 | DBV | 5 | 3000 | 178.0 | 8.4 | 3.2 | 3.2 | 1.4 | 4.0 | 8.0 | Q3 |
| LM4132AMFX-2.5/NOPB | SOT-23 | DBV | 5 | 3000 | 178.0 | 8.4 | 3.2 | 3.2 | 1.4 | 4.0 | 8.0 | Q3 |
| LM4132AMFX-3.0/NOPB | SOT-23 | DBV | 5 | 3000 | 178.0 | 8.4 | 3.2 | 3.2 | 1.4 | 4.0 | 8.0 | Q3 |
| LM4132AMFX-3.3/NOPB | SOT-23 | DBV | 5 | 3000 | 178.0 | 8.4 | 3.2 | 3.2 | 1.4 | 4.0 | 8.0 | Q3 |
| LM4132AMFX-4.1/NOPB | SOT-23 | DBV | 5 | 3000 | 178.0 | 8.4 | 3.2 | 3.2 | 1.4 | 4.0 | 8.0 | Q3 |
| LM4132AQ1MFR2.5 | SOT-23 | DBV | 5 | 3000 | 178.0 | 8.4 | 3.2 | 3.2 | 1.4 | 4.0 | 8.0 | Q3 |
| LM4132AQ1MFR3.0 | SOT-23 | DBV | 5 | 3000 | 178.0 | 8.4 | 3.2 | 3.2 | 1.4 | 4.0 | 8.0 | Q3 |
| LM4132AQ1MFT2.5 | SOT-23 | DBV | 5 | 250 | 178.0 | 8.4 | 3.2 | 3.2 | 1.4 | 4.0 | 8.0 | Q3 |
| LM4132AQ1MFT3.0 | SOT-23 | DBV | 5 | 250 | 178.0 | 8.4 | 3.2 | 3.2 | 1.4 | 4.0 | 8.0 | Q3 |
| LM4132BMF-1.8/NOPB | SOT-23 | DBV | 5 | 1000 | 178.0 | 8.4 | 3.2 | 3.2 | 1.4 | 4.0 | 8.0 | Q3 |
| LM4132BMF-2.0/NOPB | SOT-23 | DBV | 5 | 1000 | 178.0 | 8.4 | 3.2 | 3.2 | 1.4 | 4.0 | 8.0 | Q3 |

| Device | Package Type | Package Drawing | Pins | SPQ | Reel Diameter (mm) | Reel Width W1 (mm) | A0 (mm) | B0 (mm) | K0 (mm) | P1 (mm) | W (mm) | Pin1 Quadrant |
|---------------------|--------------|-----------------|------|------|--------------------|--------------------|---------|---------|---------|---------|--------|---------------|
| LM4132BMF-2.5/NOPB | SOT-23 | DBV | 5 | 1000 | 178.0 | 8.4 | 3.2 | 3.2 | 1.4 | 4.0 | 8.0 | Q3 |
| LM4132BMF-3.0/NOPB | SOT-23 | DBV | 5 | 1000 | 178.0 | 8.4 | 3.2 | 3.2 | 1.4 | 4.0 | 8.0 | Q3 |
| LM4132BMF-3.3/NOPB | SOT-23 | DBV | 5 | 1000 | 178.0 | 8.4 | 3.2 | 3.2 | 1.4 | 4.0 | 8.0 | Q3 |
| LM4132BMF-4.1/NOPB | SOT-23 | DBV | 5 | 1000 | 178.0 | 8.4 | 3.2 | 3.2 | 1.4 | 4.0 | 8.0 | Q3 |
| LM4132BMFX-1.8/NOPB | SOT-23 | DBV | 5 | 3000 | 178.0 | 8.4 | 3.2 | 3.2 | 1.4 | 4.0 | 8.0 | Q3 |
| LM4132BMFX-2.0/NOPB | SOT-23 | DBV | 5 | 3000 | 178.0 | 8.4 | 3.2 | 3.2 | 1.4 | 4.0 | 8.0 | Q3 |
| LM4132BMFX-2.5/NOPB | SOT-23 | DBV | 5 | 3000 | 178.0 | 8.4 | 3.2 | 3.2 | 1.4 | 4.0 | 8.0 | Q3 |
| LM4132BMFX-3.0/NOPB | SOT-23 | DBV | 5 | 3000 | 178.0 | 8.4 | 3.2 | 3.2 | 1.4 | 4.0 | 8.0 | Q3 |
| LM4132BMFX-3.3/NOPB | SOT-23 | DBV | 5 | 3000 | 178.0 | 8.4 | 3.2 | 3.2 | 1.4 | 4.0 | 8.0 | Q3 |
| LM4132BMFX-4.1/NOPB | SOT-23 | DBV | 5 | 3000 | 178.0 | 8.4 | 3.2 | 3.2 | 1.4 | 4.0 | 8.0 | Q3 |
| LM4132BQ1MFR2.5 | SOT-23 | DBV | 5 | 3000 | 178.0 | 8.4 | 3.2 | 3.2 | 1.4 | 4.0 | 8.0 | Q3 |
| LM4132BQ1MFR3.0 | SOT-23 | DBV | 5 | 3000 | 178.0 | 8.4 | 3.2 | 3.2 | 1.4 | 4.0 | 8.0 | Q3 |
| LM4132BQ1MFT2.5 | SOT-23 | DBV | 5 | 250 | 178.0 | 8.4 | 3.2 | 3.2 | 1.4 | 4.0 | 8.0 | Q3 |
| LM4132BQ1MFT3.0 | SOT-23 | DBV | 5 | 250 | 178.0 | 8.4 | 3.2 | 3.2 | 1.4 | 4.0 | 8.0 | Q3 |
| LM4132CMF-1.8/NOPB | SOT-23 | DBV | 5 | 1000 | 178.0 | 8.4 | 3.2 | 3.2 | 1.4 | 4.0 | 8.0 | Q3 |
| LM4132CMF-2.0/NOPB | SOT-23 | DBV | 5 | 1000 | 178.0 | 8.4 | 3.2 | 3.2 | 1.4 | 4.0 | 8.0 | Q3 |
| LM4132CMF-2.5/NOPB | SOT-23 | DBV | 5 | 1000 | 178.0 | 8.4 | 3.2 | 3.2 | 1.4 | 4.0 | 8.0 | Q3 |
| LM4132CMF-3.0/NOPB | SOT-23 | DBV | 5 | 1000 | 178.0 | 8.4 | 3.2 | 3.2 | 1.4 | 4.0 | 8.0 | Q3 |
| LM4132CMF-3.3/NOPB | SOT-23 | DBV | 5 | 1000 | 178.0 | 8.4 | 3.2 | 3.2 | 1.4 | 4.0 | 8.0 | Q3 |
| LM4132CMF-4.1/NOPB | SOT-23 | DBV | 5 | 1000 | 178.0 | 8.4 | 3.2 | 3.2 | 1.4 | 4.0 | 8.0 | Q3 |
| LM4132CMFX-1.8/NOPB | SOT-23 | DBV | 5 | 3000 | 178.0 | 8.4 | 3.2 | 3.2 | 1.4 | 4.0 | 8.0 | Q3 |
| LM4132CMFX-2.0/NOPB | SOT-23 | DBV | 5 | 3000 | 178.0 | 8.4 | 3.2 | 3.2 | 1.4 | 4.0 | 8.0 | Q3 |
| LM4132CMFX-2.5/NOPB | SOT-23 | DBV | 5 | 3000 | 178.0 | 8.4 | 3.2 | 3.2 | 1.4 | 4.0 | 8.0 | Q3 |
| LM4132CMFX-3.0/NOPB | SOT-23 | DBV | 5 | 3000 | 178.0 | 8.4 | 3.2 | 3.2 | 1.4 | 4.0 | 8.0 | Q3 |
| LM4132CMFX-3.3/NOPB | SOT-23 | DBV | 5 | 3000 | 178.0 | 8.4 | 3.2 | 3.2 | 1.4 | 4.0 | 8.0 | Q3 |
| LM4132CMFX-4.1/NOPB | SOT-23 | DBV | 5 | 3000 | 178.0 | 8.4 | 3.2 | 3.2 | 1.4 | 4.0 | 8.0 | Q3 |
| LM4132CQ1MFR2.5 | SOT-23 | DBV | 5 | 3000 | 178.0 | 8.4 | 3.2 | 3.2 | 1.4 | 4.0 | 8.0 | Q3 |
| LM4132CQ1MFR3.0 | SOT-23 | DBV | 5 | 3000 | 178.0 | 8.4 | 3.2 | 3.2 | 1.4 | 4.0 | 8.0 | Q3 |
| LM4132CQ1MFR3.3 | SOT-23 | DBV | 5 | 3000 | 178.0 | 8.4 | 3.2 | 3.2 | 1.4 | 4.0 | 8.0 | Q3 |
| LM4132CQ1MFT2.5 | SOT-23 | DBV | 5 | 250 | 178.0 | 8.4 | 3.2 | 3.2 | 1.4 | 4.0 | 8.0 | Q3 |
| LM4132CQ1MFT3.0 | SOT-23 | DBV | 5 | 250 | 178.0 | 8.4 | 3.2 | 3.2 | 1.4 | 4.0 | 8.0 | Q3 |
| LM4132CQ1MFT3.3 | SOT-23 | DBV | 5 | 250 | 178.0 | 8.4 | 3.2 | 3.2 | 1.4 | 4.0 | 8.0 | Q3 |
| LM4132DMF-1.8/NOPB | SOT-23 | DBV | 5 | 1000 | 178.0 | 8.4 | 3.2 | 3.2 | 1.4 | 4.0 | 8.0 | Q3 |
| LM4132DMF-2.0/NOPB | SOT-23 | DBV | 5 | 1000 | 178.0 | 8.4 | 3.2 | 3.2 | 1.4 | 4.0 | 8.0 | Q3 |
| LM4132DMF-2.5/NOPB | SOT-23 | DBV | 5 | 1000 | 178.0 | 8.4 | 3.2 | 3.2 | 1.4 | 4.0 | 8.0 | Q3 |
| LM4132DMF-3.0/NOPB | SOT-23 | DBV | 5 | 1000 | 178.0 | 8.4 | 3.2 | 3.2 | 1.4 | 4.0 | 8.0 | Q3 |
| LM4132DMF-3.3/NOPB | SOT-23 | DBV | 5 | 1000 | 178.0 | 8.4 | 3.2 | 3.2 | 1.4 | 4.0 | 8.0 | Q3 |
| LM4132DMF-4.1/NOPB | SOT-23 | DBV | 5 | 1000 | 178.0 | 8.4 | 3.2 | 3.2 | 1.4 | 4.0 | 8.0 | Q3 |
| LM4132DMFX-1.8/NOPB | SOT-23 | DBV | 5 | 3000 | 178.0 | 8.4 | 3.2 | 3.2 | 1.4 | 4.0 | 8.0 | Q3 |
| LM4132DMFX-2.0/NOPB | SOT-23 | DBV | 5 | 3000 | 178.0 | 8.4 | 3.2 | 3.2 | 1.4 | 4.0 | 8.0 | Q3 |
| LM4132DMFX-2.5/NOPB | SOT-23 | DBV | 5 | 3000 | 178.0 | 8.4 | 3.2 | 3.2 | 1.4 | 4.0 | 8.0 | Q3 |
| LM4132DMFX-3.0/NOPB | SOT-23 | DBV | 5 | 3000 | 178.0 | 8.4 | 3.2 | 3.2 | 1.4 | 4.0 | 8.0 | Q3 |
| LM4132DMFX-3.3/NOPB | SOT-23 | DBV | 5 | 3000 | 178.0 | 8.4 | 3.2 | 3.2 | 1.4 | 4.0 | 8.0 | Q3 |

| Device | Package Type | Package Drawing | Pins | SPQ | Reel Diameter (mm) | Reel Width W1 (mm) | A0 (mm) | B0 (mm) | K0 (mm) | P1 (mm) | W (mm) | Pin1 Quadrant |
|---------------------|--------------|-----------------|------|------|--------------------|--------------------|---------|---------|---------|---------|--------|---------------|
| LM4132DMFX-4.1/NOPB | SOT-23 | DBV | 5 | 3000 | 178.0 | 8.4 | 3.2 | 3.2 | 1.4 | 4.0 | 8.0 | Q3 |
| LM4132DQ1MFR2.5 | SOT-23 | DBV | 5 | 3000 | 178.0 | 8.4 | 3.2 | 3.2 | 1.4 | 4.0 | 8.0 | Q3 |
| LM4132DQ1MFR3.0 | SOT-23 | DBV | 5 | 3000 | 178.0 | 8.4 | 3.2 | 3.2 | 1.4 | 4.0 | 8.0 | Q3 |
| LM4132DQ1MFR3.3 | SOT-23 | DBV | 5 | 3000 | 178.0 | 8.4 | 3.2 | 3.2 | 1.4 | 4.0 | 8.0 | Q3 |
| LM4132DQ1MFT2.5 | SOT-23 | DBV | 5 | 250 | 178.0 | 8.4 | 3.2 | 3.2 | 1.4 | 4.0 | 8.0 | Q3 |
| LM4132DQ1MFT3.0 | SOT-23 | DBV | 5 | 250 | 178.0 | 8.4 | 3.2 | 3.2 | 1.4 | 4.0 | 8.0 | Q3 |
| LM4132DQ1MFT3.3 | SOT-23 | DBV | 5 | 250 | 178.0 | 8.4 | 3.2 | 3.2 | 1.4 | 4.0 | 8.0 | Q3 |
| LM4132EMF-1.8/NOPB | SOT-23 | DBV | 5 | 1000 | 178.0 | 8.4 | 3.2 | 3.2 | 1.4 | 4.0 | 8.0 | Q3 |
| LM4132EMF-2.0/NOPB | SOT-23 | DBV | 5 | 1000 | 178.0 | 8.4 | 3.2 | 3.2 | 1.4 | 4.0 | 8.0 | Q3 |
| LM4132EMF-2.5/NOPB | SOT-23 | DBV | 5 | 1000 | 178.0 | 8.4 | 3.2 | 3.2 | 1.4 | 4.0 | 8.0 | Q3 |
| LM4132EMF-3.0/NOPB | SOT-23 | DBV | 5 | 1000 | 178.0 | 8.4 | 3.2 | 3.2 | 1.4 | 4.0 | 8.0 | Q3 |
| LM4132EMF-3.3/NOPB | SOT-23 | DBV | 5 | 1000 | 178.0 | 8.4 | 3.2 | 3.2 | 1.4 | 4.0 | 8.0 | Q3 |
| LM4132EMF-4.1/NOPB | SOT-23 | DBV | 5 | 1000 | 178.0 | 8.4 | 3.2 | 3.2 | 1.4 | 4.0 | 8.0 | Q3 |
| LM4132EMFX-1.8/NOPB | SOT-23 | DBV | 5 | 3000 | 178.0 | 8.4 | 3.2 | 3.2 | 1.4 | 4.0 | 8.0 | Q3 |
| LM4132EMFX-2.0/NOPB | SOT-23 | DBV | 5 | 3000 | 178.0 | 8.4 | 3.2 | 3.2 | 1.4 | 4.0 | 8.0 | Q3 |
| LM4132EMFX-2.5/NOPB | SOT-23 | DBV | 5 | 3000 | 178.0 | 8.4 | 3.2 | 3.2 | 1.4 | 4.0 | 8.0 | Q3 |
| LM4132EMFX-3.0/NOPB | SOT-23 | DBV | 5 | 3000 | 178.0 | 8.4 | 3.2 | 3.2 | 1.4 | 4.0 | 8.0 | Q3 |
| LM4132EMFX-3.3/NOPB | SOT-23 | DBV | 5 | 3000 | 178.0 | 8.4 | 3.2 | 3.2 | 1.4 | 4.0 | 8.0 | Q3 |
| LM4132EMFX-4.1/NOPB | SOT-23 | DBV | 5 | 3000 | 178.0 | 8.4 | 3.2 | 3.2 | 1.4 | 4.0 | 8.0 | Q3 |

TAPE AND REEL BOX DIMENSIONS



*All dimensions are nominal

| Device | Package Type | Package Drawing | Pins | SPQ | Length (mm) | Width (mm) | Height (mm) |
|---------------------|--------------|-----------------|------|------|-------------|------------|-------------|
| LM4132AMF-1.8/NOPB | SOT-23 | DBV | 5 | 1000 | 210.0 | 185.0 | 35.0 |
| LM4132AMF-2.0/NOPB | SOT-23 | DBV | 5 | 1000 | 210.0 | 185.0 | 35.0 |
| LM4132AMF-2.5/NOPB | SOT-23 | DBV | 5 | 1000 | 210.0 | 185.0 | 35.0 |
| LM4132AMF-3.0/NOPB | SOT-23 | DBV | 5 | 1000 | 210.0 | 185.0 | 35.0 |
| LM4132AMF-3.3/NOPB | SOT-23 | DBV | 5 | 1000 | 210.0 | 185.0 | 35.0 |
| LM4132AMF-4.1/NOPB | SOT-23 | DBV | 5 | 1000 | 210.0 | 185.0 | 35.0 |
| LM4132AMFX-1.8/NOPB | SOT-23 | DBV | 5 | 3000 | 210.0 | 185.0 | 35.0 |
| LM4132AMFX-2.0/NOPB | SOT-23 | DBV | 5 | 3000 | 210.0 | 185.0 | 35.0 |
| LM4132AMFX-2.5/NOPB | SOT-23 | DBV | 5 | 3000 | 210.0 | 185.0 | 35.0 |
| LM4132AMFX-3.0/NOPB | SOT-23 | DBV | 5 | 3000 | 210.0 | 185.0 | 35.0 |
| LM4132AMFX-3.3/NOPB | SOT-23 | DBV | 5 | 3000 | 210.0 | 185.0 | 35.0 |
| LM4132AMFX-4.1/NOPB | SOT-23 | DBV | 5 | 3000 | 210.0 | 185.0 | 35.0 |
| LM4132AQ1MFR2.5 | SOT-23 | DBV | 5 | 3000 | 210.0 | 185.0 | 35.0 |
| LM4132AQ1MFR3.0 | SOT-23 | DBV | 5 | 3000 | 210.0 | 185.0 | 35.0 |
| LM4132AQ1MFT2.5 | SOT-23 | DBV | 5 | 250 | 210.0 | 185.0 | 35.0 |
| LM4132AQ1MFT3.0 | SOT-23 | DBV | 5 | 250 | 210.0 | 185.0 | 35.0 |
| LM4132BMF-1.8/NOPB | SOT-23 | DBV | 5 | 1000 | 210.0 | 185.0 | 35.0 |
| LM4132BMF-2.0/NOPB | SOT-23 | DBV | 5 | 1000 | 210.0 | 185.0 | 35.0 |
| LM4132BMF-2.5/NOPB | SOT-23 | DBV | 5 | 1000 | 210.0 | 185.0 | 35.0 |
| LM4132BMF-3.0/NOPB | SOT-23 | DBV | 5 | 1000 | 210.0 | 185.0 | 35.0 |
| LM4132BMF-3.3/NOPB | SOT-23 | DBV | 5 | 1000 | 210.0 | 185.0 | 35.0 |
| LM4132BMF-4.1/NOPB | SOT-23 | DBV | 5 | 1000 | 210.0 | 185.0 | 35.0 |
| LM4132BMFX-1.8/NOPB | SOT-23 | DBV | 5 | 3000 | 210.0 | 185.0 | 35.0 |
| LM4132BMFX-2.0/NOPB | SOT-23 | DBV | 5 | 3000 | 210.0 | 185.0 | 35.0 |
| LM4132BMFX-2.5/NOPB | SOT-23 | DBV | 5 | 3000 | 210.0 | 185.0 | 35.0 |
| LM4132BMFX-3.0/NOPB | SOT-23 | DBV | 5 | 3000 | 210.0 | 185.0 | 35.0 |
| LM4132BMFX-3.3/NOPB | SOT-23 | DBV | 5 | 3000 | 210.0 | 185.0 | 35.0 |
| LM4132BMFX-4.1/NOPB | SOT-23 | DBV | 5 | 3000 | 210.0 | 185.0 | 35.0 |
| LM4132BQ1MFR2.5 | SOT-23 | DBV | 5 | 3000 | 210.0 | 185.0 | 35.0 |
| LM4132BQ1MFR3.0 | SOT-23 | DBV | 5 | 3000 | 210.0 | 185.0 | 35.0 |
| LM4132BQ1MFT2.5 | SOT-23 | DBV | 5 | 250 | 210.0 | 185.0 | 35.0 |
| LM4132BQ1MFT3.0 | SOT-23 | DBV | 5 | 250 | 210.0 | 185.0 | 35.0 |
| LM4132CMF-1.8/NOPB | SOT-23 | DBV | 5 | 1000 | 210.0 | 185.0 | 35.0 |
| LM4132CMF-2.0/NOPB | SOT-23 | DBV | 5 | 1000 | 210.0 | 185.0 | 35.0 |
| LM4132CMF-2.5/NOPB | SOT-23 | DBV | 5 | 1000 | 210.0 | 185.0 | 35.0 |
| LM4132CMF-3.0/NOPB | SOT-23 | DBV | 5 | 1000 | 210.0 | 185.0 | 35.0 |
| LM4132CMF-3.3/NOPB | SOT-23 | DBV | 5 | 1000 | 210.0 | 185.0 | 35.0 |
| LM4132CMF-4.1/NOPB | SOT-23 | DBV | 5 | 1000 | 210.0 | 185.0 | 35.0 |
| LM4132CMFX-1.8/NOPB | SOT-23 | DBV | 5 | 3000 | 210.0 | 185.0 | 35.0 |
| LM4132CMFX-2.0/NOPB | SOT-23 | DBV | 5 | 3000 | 210.0 | 185.0 | 35.0 |
| LM4132CMFX-2.5/NOPB | SOT-23 | DBV | 5 | 3000 | 210.0 | 185.0 | 35.0 |
| LM4132CMFX-3.0/NOPB | SOT-23 | DBV | 5 | 3000 | 210.0 | 185.0 | 35.0 |
| LM4132CMFX-3.3/NOPB | SOT-23 | DBV | 5 | 3000 | 210.0 | 185.0 | 35.0 |

| Device | Package Type | Package Drawing | Pins | SPQ | Length (mm) | Width (mm) | Height (mm) |
|---------------------|--------------|-----------------|------|------|-------------|------------|-------------|
| LM4132CMFX-4.1/NOPB | SOT-23 | DBV | 5 | 3000 | 210.0 | 185.0 | 35.0 |
| LM4132CQ1MFR2.5 | SOT-23 | DBV | 5 | 3000 | 210.0 | 185.0 | 35.0 |
| LM4132CQ1MFR3.0 | SOT-23 | DBV | 5 | 3000 | 210.0 | 185.0 | 35.0 |
| LM4132CQ1MFR3.3 | SOT-23 | DBV | 5 | 3000 | 210.0 | 185.0 | 35.0 |
| LM4132CQ1MFT2.5 | SOT-23 | DBV | 5 | 250 | 210.0 | 185.0 | 35.0 |
| LM4132CQ1MFT3.0 | SOT-23 | DBV | 5 | 250 | 210.0 | 185.0 | 35.0 |
| LM4132CQ1MFT3.3 | SOT-23 | DBV | 5 | 250 | 210.0 | 185.0 | 35.0 |
| LM4132DMF-1.8/NOPB | SOT-23 | DBV | 5 | 1000 | 210.0 | 185.0 | 35.0 |
| LM4132DMF-2.0/NOPB | SOT-23 | DBV | 5 | 1000 | 210.0 | 185.0 | 35.0 |
| LM4132DMF-2.5/NOPB | SOT-23 | DBV | 5 | 1000 | 210.0 | 185.0 | 35.0 |
| LM4132DMF-3.0/NOPB | SOT-23 | DBV | 5 | 1000 | 210.0 | 185.0 | 35.0 |
| LM4132DMF-3.3/NOPB | SOT-23 | DBV | 5 | 1000 | 210.0 | 185.0 | 35.0 |
| LM4132DMF-4.1/NOPB | SOT-23 | DBV | 5 | 1000 | 210.0 | 185.0 | 35.0 |
| LM4132DMFX-1.8/NOPB | SOT-23 | DBV | 5 | 3000 | 210.0 | 185.0 | 35.0 |
| LM4132DMFX-2.0/NOPB | SOT-23 | DBV | 5 | 3000 | 210.0 | 185.0 | 35.0 |
| LM4132DMFX-2.5/NOPB | SOT-23 | DBV | 5 | 3000 | 210.0 | 185.0 | 35.0 |
| LM4132DMFX-3.0/NOPB | SOT-23 | DBV | 5 | 3000 | 210.0 | 185.0 | 35.0 |
| LM4132DMFX-3.3/NOPB | SOT-23 | DBV | 5 | 3000 | 210.0 | 185.0 | 35.0 |
| LM4132DMFX-4.1/NOPB | SOT-23 | DBV | 5 | 3000 | 210.0 | 185.0 | 35.0 |
| LM4132DQ1MFR2.5 | SOT-23 | DBV | 5 | 3000 | 210.0 | 185.0 | 35.0 |
| LM4132DQ1MFR3.0 | SOT-23 | DBV | 5 | 3000 | 210.0 | 185.0 | 35.0 |
| LM4132DQ1MFR3.3 | SOT-23 | DBV | 5 | 3000 | 210.0 | 185.0 | 35.0 |
| LM4132DQ1MFT2.5 | SOT-23 | DBV | 5 | 250 | 210.0 | 185.0 | 35.0 |
| LM4132DQ1MFT3.0 | SOT-23 | DBV | 5 | 250 | 210.0 | 185.0 | 35.0 |
| LM4132DQ1MFT3.3 | SOT-23 | DBV | 5 | 250 | 210.0 | 185.0 | 35.0 |
| LM4132EMF-1.8/NOPB | SOT-23 | DBV | 5 | 1000 | 210.0 | 185.0 | 35.0 |
| LM4132EMF-2.0/NOPB | SOT-23 | DBV | 5 | 1000 | 210.0 | 185.0 | 35.0 |
| LM4132EMF-2.5/NOPB | SOT-23 | DBV | 5 | 1000 | 210.0 | 185.0 | 35.0 |
| LM4132EMF-3.0/NOPB | SOT-23 | DBV | 5 | 1000 | 210.0 | 185.0 | 35.0 |
| LM4132EMF-3.3/NOPB | SOT-23 | DBV | 5 | 1000 | 210.0 | 185.0 | 35.0 |
| LM4132EMF-4.1/NOPB | SOT-23 | DBV | 5 | 1000 | 210.0 | 185.0 | 35.0 |
| LM4132EMFX-1.8/NOPB | SOT-23 | DBV | 5 | 3000 | 210.0 | 185.0 | 35.0 |
| LM4132EMFX-2.0/NOPB | SOT-23 | DBV | 5 | 3000 | 210.0 | 185.0 | 35.0 |
| LM4132EMFX-2.5/NOPB | SOT-23 | DBV | 5 | 3000 | 210.0 | 185.0 | 35.0 |
| LM4132EMFX-3.0/NOPB | SOT-23 | DBV | 5 | 3000 | 210.0 | 185.0 | 35.0 |
| LM4132EMFX-3.3/NOPB | SOT-23 | DBV | 5 | 3000 | 210.0 | 185.0 | 35.0 |
| LM4132EMFX-4.1/NOPB | SOT-23 | DBV | 5 | 3000 | 210.0 | 185.0 | 35.0 |

DBV0005A



PACKAGE OUTLINE

SOT-23 - 1.45 mm max height

SMALL OUTLINE TRANSISTOR

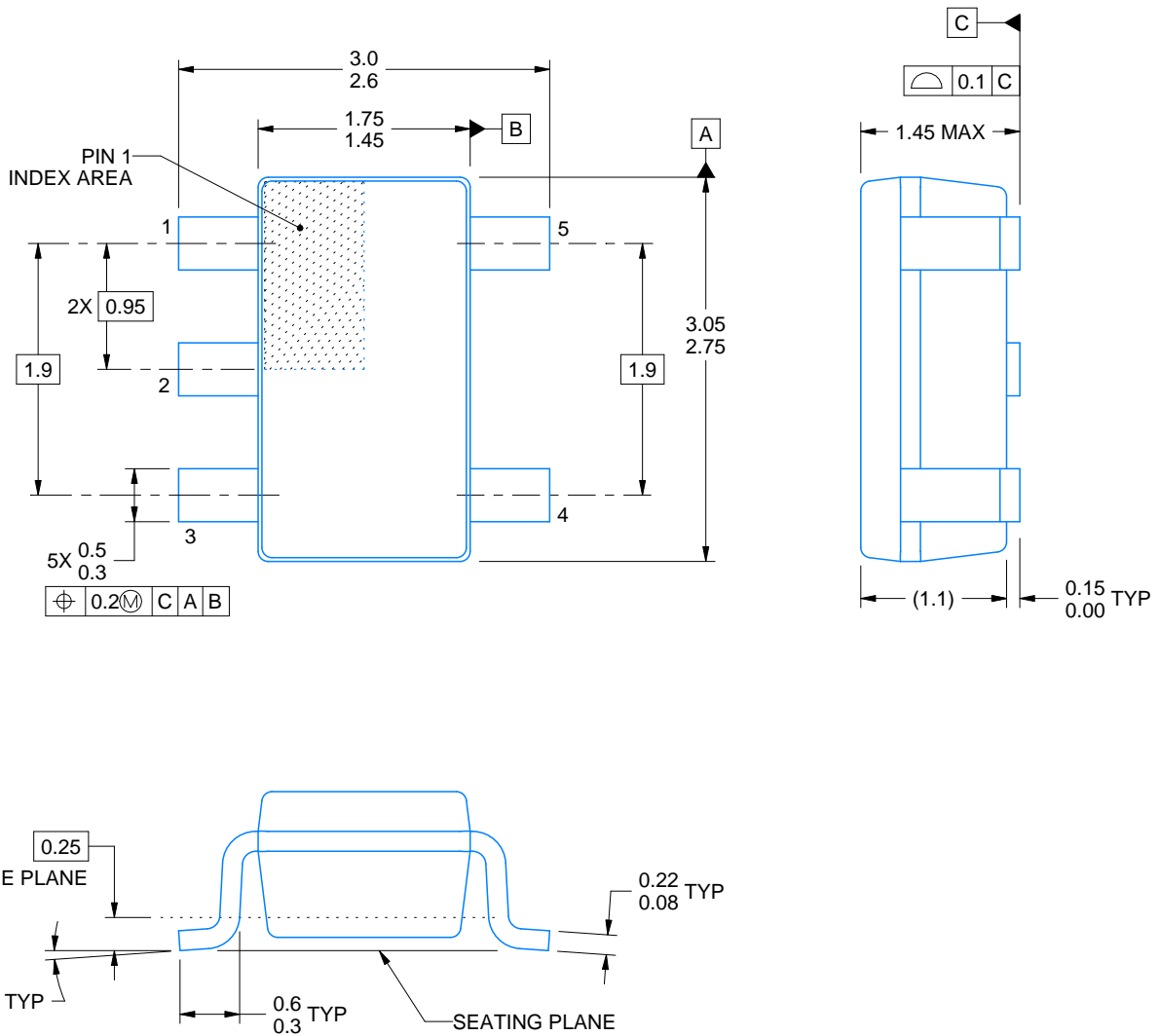

4214839/D 11/2018

NOTES:

1. All linear dimensions are in millimeters. Any dimensions in parenthesis are for reference only. Dimensioning and tolerancing per ASME Y14.5M.
2. This drawing is subject to change without notice.
3. Reference JEDEC MO-178.
4. Body dimensions do not include mold flash, protrusions, or gate burrs. Mold flash, protrusions, or gate burrs shall not exceed 0.15 mm per side.

EXAMPLE BOARD LAYOUT

DBV0005A

SOT-23 - 1.45 mm max height

SMALL OUTLINE TRANSISTOR



LAND PATTERN EXAMPLE
EXPOSED METAL SHOWN
SCALE:15X



SOLDER MASK DETAILS

4214839/D 11/2018

NOTES: (continued)

- 5. Publication IPC-7351 may have alternate designs.
- 6. Solder mask tolerances between and around signal pads can vary based on board fabrication site.

EXAMPLE STENCIL DESIGN

DBV0005A

SOT-23 - 1.45 mm max height

SMALL OUTLINE TRANSISTOR



SOLDER PASTE EXAMPLE
BASED ON 0.125 mm THICK STENCIL
SCALE:15X

4214839/D 11/2018

NOTES: (continued)

7. Laser cutting apertures with trapezoidal walls and rounded corners may offer better paste release. IPC-7525 may have alternate design recommendations.
8. Board assembly site may have different recommendations for stencil design.

IMPORTANT NOTICE AND DISCLAIMER

TI PROVIDES TECHNICAL AND RELIABILITY DATA (INCLUDING DATASHEETS), DESIGN RESOURCES (INCLUDING REFERENCE DESIGNS), APPLICATION OR OTHER DESIGN ADVICE, WEB TOOLS, SAFETY INFORMATION, AND OTHER RESOURCES "AS IS" AND WITH ALL FAULTS, AND DISCLAIMS ALL WARRANTIES, EXPRESS AND IMPLIED, INCLUDING WITHOUT LIMITATION ANY IMPLIED WARRANTIES OF MERCHANTABILITY, FITNESS FOR A PARTICULAR PURPOSE OR NON-INFRINGEMENT OF THIRD PARTY INTELLECTUAL PROPERTY RIGHTS.

These resources are intended for skilled developers designing with TI products. You are solely responsible for (1) selecting the appropriate TI products for your application, (2) designing, validating and testing your application, and (3) ensuring your application meets applicable standards, and any other safety, security, or other requirements. These resources are subject to change without notice. TI grants you permission to use these resources only for development of an application that uses the TI products described in the resource. Other reproduction and display of these resources is prohibited. No license is granted to any other TI intellectual property right or to any third party intellectual property right. TI disclaims responsibility for, and you will fully indemnify TI and its representatives against, any claims, damages, costs, losses, and liabilities arising out of your use of these resources.

TI's products are provided subject to TI's Terms of Sale (www.ti.com/legal/termsofsale.html) or other applicable terms available either on ti.com or provided in conjunction with such TI products. TI's provision of these resources does not expand or otherwise alter TI's applicable warranties or warranty disclaimers for TI products.

Mailing Address: Texas Instruments, Post Office Box 655303, Dallas, Texas 75265
Copyright © 2019, Texas Instruments Incorporated

Looking for pricing, stock, or lifecycle information?

Click below to explore more details on WIN SOURCE:

- ⊖ [View LM4132CMFX-3.0/NOPB on WIN SOURCE](#)
- ⊖ [Texas Instruments](#) Information

Optimize Your Supply Chain with WIN SOURCE Solutions

- ✓ Global Sourcing Solution
- ✓ Obsolete Management
- ✓ Cost Control Management
- ✓ Shortage Management
- ✓ Alternative Solution
- ✓ Excess Inventory Management