



THE DATASHEET OF LM431SCCMLX



LM431SA, LM431SB, LM431SC



ON Semiconductor®

www.onsemi.com

Programmable Shunt Regulator

Description

The LM431SA / LM431SB / LM431SC are three-terminal the output adjustable regulators with thermal stability over operating temperature range. The output voltage can be set any value between V_{REF} (approximately 2.5 V) and 36 V with two external resistors. These devices have a typical dynamic output impedance of 0.2 Ω . Active output circuit provides a sharp turn-on characteristic, making these devices excellent replacement for zener diodes in many applications.

Features

- Programmable Output Voltage to 36 V
- Low Dynamic Output Impedance: 0.2 Ω (Typical)
- Sink Current Capability: 1.0 to 100 mA
- Equivalent Full-Range Temperature Coefficient of 50 ppm/ $^{\circ}$ C (Typical)
- Temperature Compensated for Operation Over Full Rated Operating Temperature Range
- Low Output Noise Voltage
- Fast Turn-on Response
- These Devices are Pb-Free, Halogen Free/BFR Free and are RoHS Compliant



1
SOT-89
CASE 528AH

1. Ref
2. Anode
3. Cathode



3
SOT-23FL
CASE 419BD

1. Cathode
2. Ref
3. Anode



3
SOT-23
CASE 318BM

- | | |
|------------|------------|
| M32 | M3 |
| 1. Ref | 1. Cathode |
| 2. Cathode | 2. Ref |
| 3. Anode | 3. Anode |

ORDERING INFORMATION

Product Number	Output Voltage Tolerance	Operating Temperature	Top Mark ⁽¹⁾	Package	Shipping [†]
LM431SACMFX	2%	-25 to +85 $^{\circ}$ C	43A □	SOT-23FL 3L	Tape and Reel
LM431SACM3X			43L ⊙	SOT-23 3L	
LM431SACM32X			43G ⊙	SOT-23 3L	
LM431SBCMLX	1%		43B	SOT-89 3L	
LM431SBCMFX			43B □	SOT-23FL 3L	
LM431SBCM3X			43M ⊙	SOT-23 3L	
LM431SBCM32X			43H ⊙	SOT-23 3L	
LM431SCCMLX	0.5%		43C	SOT-89 3L	
LM431SCCMFX			43C □	SOT-23FL 3L	
LM431SCCM3X			43N ⊙	SOT-23 3L	
LM431SCCM32X		43J ⊙	SOT-23 3L		
LM431SAIMFX	2%	-40 to +85 $^{\circ}$ C	43AI	SOT-23FL 3L	
LM431SBIMFX	1%		43BI	SOT-23FL 3L	
LM431SCIMFX	0.5%		43CI	SOT-23FL 3L	

[†]For information on tape and reel specifications, including part orientation and tape sizes, please refer to our Tape and Reel Packaging Specification Brochure, BRD8011/D.

1. SOT-23 and SOT-23FL have basically four-character marking except LM431SAIMFX. (3 letters for device code + 1 letter for date code) SOT-23FL date code is composed of 1 digit numeric or alphabetic week code adding bar-type year code.

LM431SA, LM431SB, LM431SC

Block Diagram

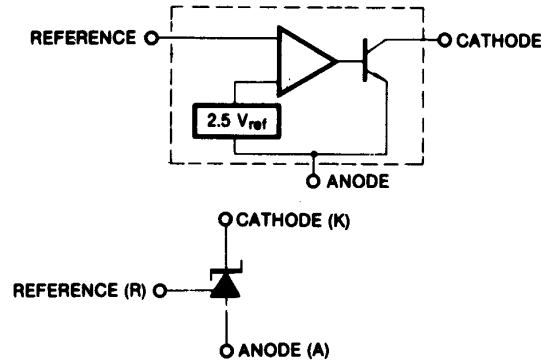

Figure 1. Block Diagram

ABSOLUTE MAXIMUM RATINGS (T_A = 25°C unless otherwise noted)

Symbol	Parameter	Value	Unit
V _{KA}	Cathode Voltage	37	V
I _{KA}	Cathode current Range (Continuous)	-100 to +150	mA
I _{REF}	Reference Input Current Range	-0.05 to +10.00	mA
R _{θJA}	Thermal Resistance Junction–Air (2, 3)	ML Suffix Package (SOT–89)	220
		MF Suffix Package (SOT–23FL)	350
		M32, M3 Suffix Package (SOT–23)	400
P _D	Power Dissipation (4, 5)	ML Suffix Package (SOT–89)	560
		MF Suffix Package (SOT–23FL)	350
		M32, M3 Suffix Package (SOT–23)	310
T _J	Junction Temperature	150	°C
T _{OPR}	Operating Temperature Range	All products except LM431SAIMFX	-25 to +85
		LM431SAIMFX, SBIMFX, SCIMFX	-40 to +85
T _{STG}	Storage Temperature Range	-65 to +150	°C

Stresses exceeding those listed in the Maximum Ratings table may damage the device. If any of these limits are exceeded, device functionality should not be assumed, damage may occur and reliability may be affected.

- Thermal resistance test board
Size: 1.6 mm x 76.2 mm x 114.3 mm (1S0P) JEDEC Standard: JESD51–3, JESD51–7.
- Assume no ambient airflow.
- T_{JMAX} = 150°C; ratings apply to ambient temperature at 25°C.
- Power dissipation calculation: P_D = (T_J – T_A) / R_{θJA}.

RECOMMENDED OPERATING CONDITIONS

Symbol	Parameter	Min.	Max.	Unit
V _{KA}	Cathode Voltage	V _{REF}	36	V
I _{KA}	Cathode Current	1	100	mA

Functional operation above the stresses listed in the Recommended Operating Ranges is not implied. Extended exposure to stresses beyond the Recommended Operating Ranges limits may affect device reliability.

LM431SA, LM431SB, LM431SC

ELECTRICAL CHARACTERISTICS (Note 6, Values are at $T_A = 25^\circ\text{C}$ unless otherwise noted)

Symbol	Parameter	Conditions	LM431SA			LM431SB			LM431SC			Unit	
			Min.	Typ.	Max.	Min.	Typ.	Max.	Min.	Typ.	Max.		
V_{REF}	Reference Input Voltage	$V_{KA} = V_{REF}, I_{KA} = 10\text{ mA}$	2.450	2.500	2.550	2.470	2.495	2.520	2.482	2.495	2.508	V	
$\Delta V_{REF} / \Delta T$	Deviation of Reference Input Voltage Over Temperature	$V_{KA} = V_{REF}, I_{KA} = 10\text{ mA}, T_{MIN} \leq T_A \leq T_{MAX}$	SOT-89 SOT-23FL		4.5	17.0		4.5	17.0		4.5	17.0	mV
			SOT-23		6.6	24		6.6	24		6.6	24	mV
$\frac{\Delta V_{REF}}{\Delta V_{KA}}$	Ratio of Change in Reference Input Voltage to the Change in Cathode Voltage	$I_{KA} = 10\text{ mA}$	$\Delta V_{KA} = 10\text{ V} - V_{REF}$		-1.0	-2.7		-1.0	-2.7		-1.0	-2.7	mV/V
			$\Delta V_{KA} = 36\text{ V} - 10\text{ V}$		-0.5	-2.0		-0.5	-2.0		-0.5	-2.0	
I_{REF}	Reference Input Current	$I_{KA} = 10\text{ mA}, R_1 = 10\text{ K}\Omega, R_2 = \infty$		1.5	4.0		1.5	4.0		1.5	4.0	μA	
$\Delta I_{REF} / \Delta T$	Deviation of Reference Input Current Over Full Temperature Range	$I_{KA} = 10\text{ mA}, R_1 = 10\text{ K}\Omega, R_2 = \infty, T_A = \text{Full Range}$	SOT-89 SOT-23FL		0.4	1.2		0.4	1.2		0.4	1.2	μA
			SOT-23		0.8	2.0		0.8	2.0		0.8	2.0	μA
$I_{KA(MIN)}$	Minimum Cathode Current for Regulation	$V_{KA} = V_{REF}$		0.45	1.00		0.45	1.00		0.45	1.00	mA	
$I_{KA(OFF)}$	Off -Stage Cathode Current	$V_{KA} = 36\text{ V}, V_{REF} = 0$		0.05	1.00		0.05	1.00		0.05	1.00	μA	
Z_{KA}	Dynamic Impedance	$V_{KA} = V_{REF}, I_{KA} = 1\text{ to }100\text{ mA}, f \geq 1.0\text{ kHz}$		0.15	0.50		0.15	0.50		0.15	0.50	Ω	

Product parametric performance is indicated in the Electrical Characteristics for the listed test conditions, unless otherwise noted. Product performance may not be indicated by the Electrical Characteristics if operated under different conditions.

6. LM431SAI, LM431SBI, LM431SCI: $-T_{A(min)} = -40^\circ\text{C}, T_{A(max)} = +85^\circ\text{C}$

All other pins: $-T_{A(min)} = -25^\circ\text{C}, T_{A(max)} = +85^\circ\text{C}$

LM431SA, LM431SB, LM431SC

ELECTRICAL CHARACTERISTICS (Continued) (Notes 7 and 8, Values are at $T_A = 25^\circ\text{C}$ unless otherwise noted)

Symbol	Parameter	Conditions	LM431SAI			LM431SBI			LM431SCI			Unit
			Min.	Typ.	Max.	Min.	Typ.	Max.	Min.	Typ.	Max.	
V_{REF}	Reference Input Voltage	$V_{KA} = V_{REF}, I_{KA} = 10 \text{ mA}$	2.450	2.500	2.550	2.470	2.495	2.520	2.482	2.495	2.508	V
$V_{REF(dev)}$	Deviation of Reference Input Voltage Over-Temperature	$V_{KA} = V_{REF}, I_{KA} = 10 \text{ mA}, T_{MIN} \leq T_A \leq T_{MAX}$		5	20		5	20		5	20	mV
$\frac{\Delta V_{REF}}{\Delta V_{KA}}$	Ratio of Change in Reference Input Voltage to Change in Cathode Voltage	$I_{KA} = 10 \text{ mA}$	$\Delta V_{KA} = 10 \text{ V} - V_{REF}$	-1.0	-2.7		-1.0	-2.7		-1.0	-2.7	mV/V
			$\Delta V_{KA} = 36 \text{ V} - 10 \text{ V}$	-0.5	-2.0		-0.5	-2.0		-0.5	-2.0	
I_{REF}	Reference Input Current	$I_{KA} = 10 \text{ mA}, R_1 = 10 \text{ K}\Omega, R_2 = \infty$		1.5	4.0		1.5	4.0		1.5	4.0	μA
$I_{REF(dev)}$	Deviation of Reference Input Current Over Full Temperature Range	$I_{KA} = 10 \text{ mA}, R_1 = 10 \text{ K}\Omega, R_2 = \infty, T_{MIN} \leq T_A \leq T_{MAX}$		0.8	2.0		0.8	2.0		0.8	2.0	μA
$I_{KA(MIN)}$	Minimum Cathode Current for Regulation	$V_{KA} = V_{REF}$		0.45	1.00		0.45	1.00		0.45	1.00	mA
$I_{KA(OFF)}$	Off-Stage Cathode Current	$V_{KA} = 36 \text{ V}, V_{REF} = 0$		0.05	1.00		0.05	1.00		0.05	1.00	μA
ZKA	Dynamic Impedance	$V_{KA} = V_{REF}, I_{KA} = 1 \text{ to } 100 \text{ mA}, f \geq 1.0 \text{ kHz}$		0.15	0.50		0.15	0.50		0.15	0.50	Ω

7. LM431SAI, LM431SBI, LM431SCI: $-T_{A(min)} = -40^\circ\text{C}, T_{A(max)} = +85^\circ\text{C}$

All other pins: $-T_{A(min)} = -25^\circ\text{C}, T_{A(max)} = +85^\circ\text{C}$

8. The deviation parameters $V_{REF(dev)}$ and $I_{REF(dev)}$ are defined as the differences between the maximum and minimum values obtained over the rated temperature range. The average full-range temperature coefficient of the reference input voltage, αV_{REF} , is defined as:

$$|\alpha V_{REF}| \left(\frac{\text{ppm}}{^\circ\text{C}} \right) = \frac{\left(\frac{V_{REF(dev)}}{V_{REF(at 25^\circ\text{C})}} \right) \cdot 10^6}{T_{MAX} - T_{MIN}}$$

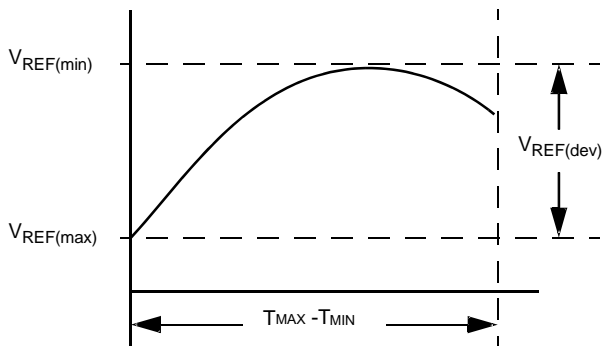

where $T_{MAX} - T_{MIN}$ is the rated operating free-air temperature range of the device.

αV_{REF} can be positive or negative, depending on whether minimum V_{REF} or maximum V_{REF} , respectively, occurs at the lower temperature.

Example:

$V_{REF(dev)} = 4.5 \text{ mV}, V_{REF} = 2500 \text{ mV}$ at 25°C ,

$T_{MAX} - T_{MIN} = 125^\circ\text{C}$ for LM431SAI.

$$|\alpha V_{REF}| = \frac{\left(\frac{4.5 \text{ mV}}{2500 \text{ mV}} \right) \cdot 10^6}{125^\circ\text{C}} = 14.4 \text{ ppm}/^\circ\text{C}$$

Because minimum V_{REF} occurs at the lower temperature, the coefficient is positive.

LM431SA, LM431SB, LM431SC

TEST CIRCUITS

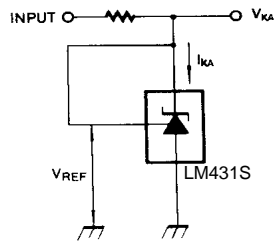

Figure 2. Test Circuit for $V_{KA} = V_{REF}$

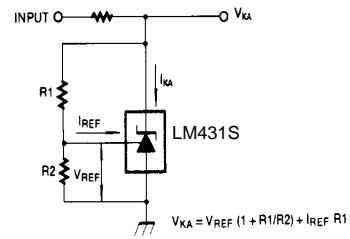

Figure 3. Test Circuit for $V_{KA} \geq V_{REF}$

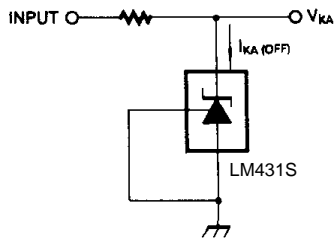

Figure 4. Test Circuit for $I_{KA(OFF)}$

LM431SA, LM431SB, LM431SC

TYPICAL APPLICATIONS

$$V_o = \left(1 + \frac{R_1}{R_2}\right) V_{ref}$$

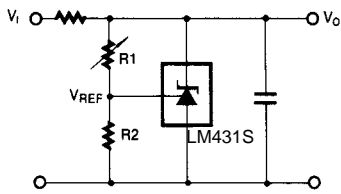

Figure 5. Shunt Regulator

$$V_o = \left(1 + \frac{R_1}{R_2}\right) V_{ref}$$

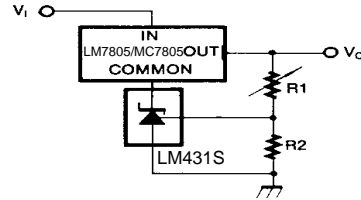

Figure 6. Output Control for Three-Terminal Fixed Regulator

$$V_o = \left(1 + \frac{R_1}{R_2}\right) V_{ref}$$

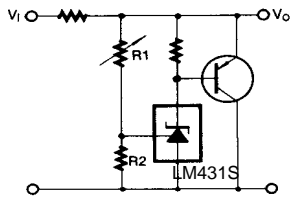

Figure 7. High Current Shunt Regulator

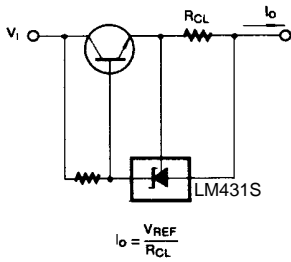

Figure 8. Current Limit or Current Source

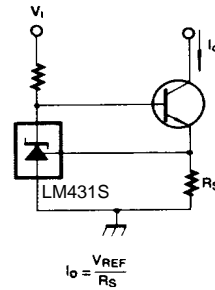

Figure 9. Constant-Current Sink

LM431SA, LM431SB, LM431SC

TYPICAL PERFORMANCE CHARACTERISTICS

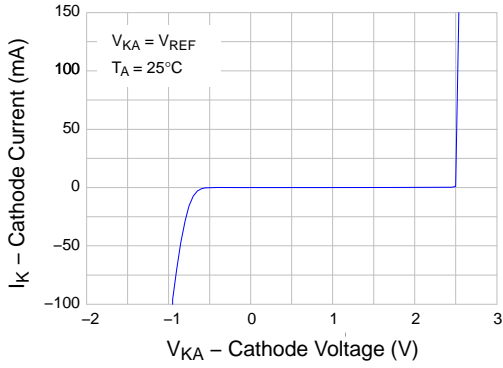

Figure 10. Cathode Current vs. Cathode Voltage

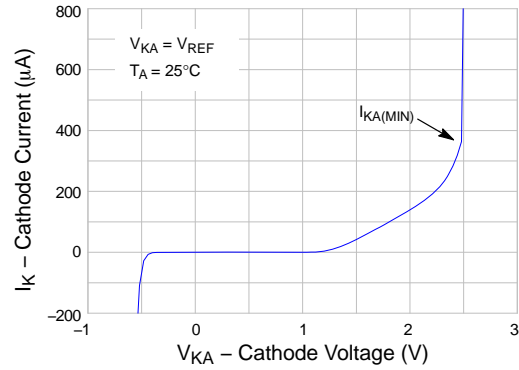

Figure 11. Cathode Current vs. Cathode Voltage

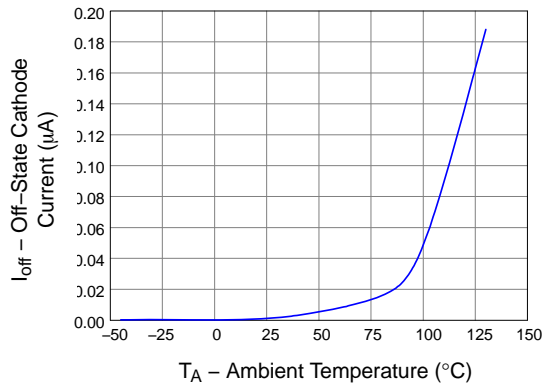

Figure 12. OFF-State Cathode Current vs. Ambient Temperature

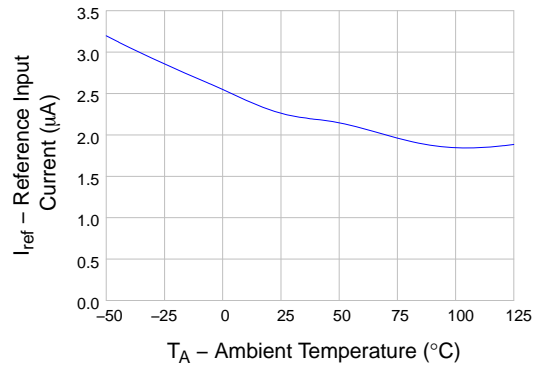

Figure 13. Reference Input Current vs. Ambient Temperature

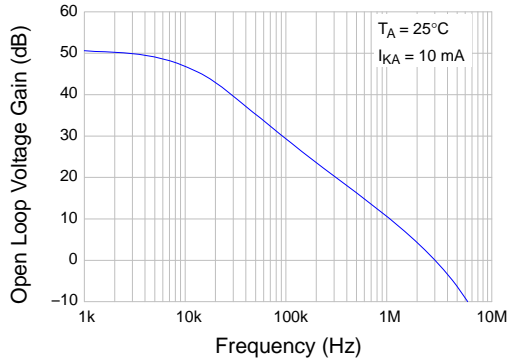

Figure 14. Frequency vs. Small Signal Voltage Amplification

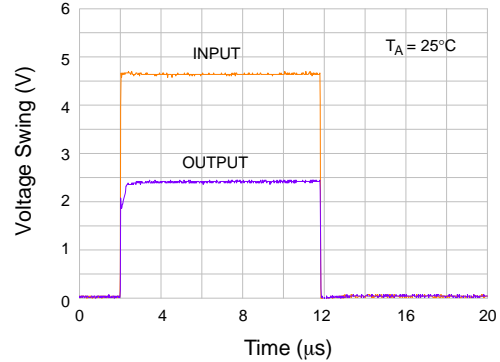

Figure 15. Pulse Response

LM431SA, LM431SB, LM431SC

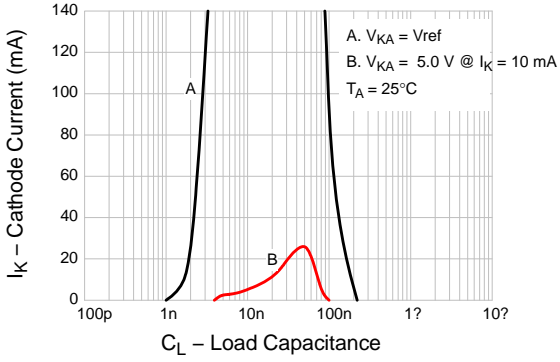

Figure 16. Stability Boundary Conditions

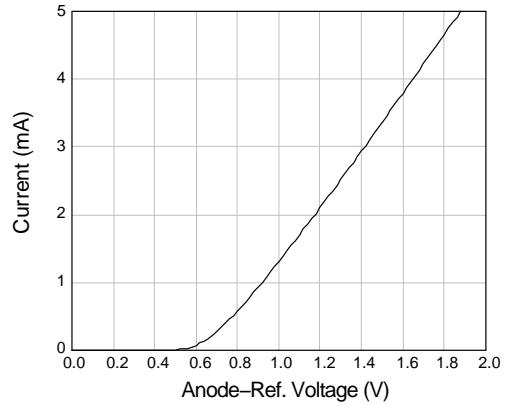

Figure 17. Anode-Reference Diode Curve

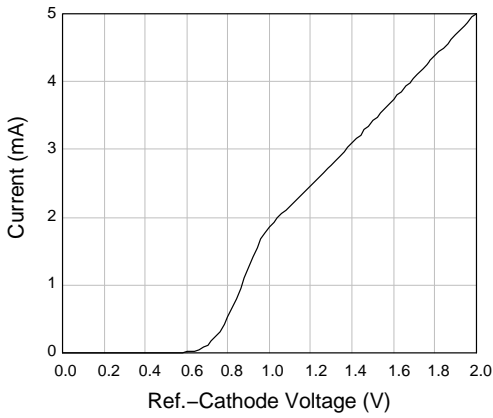

Figure 18. Reference-Cathode Diode Curve

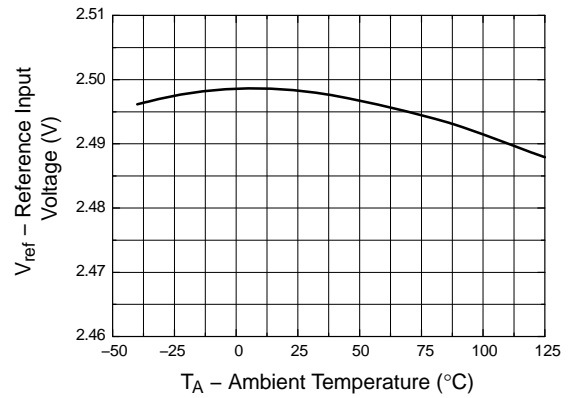
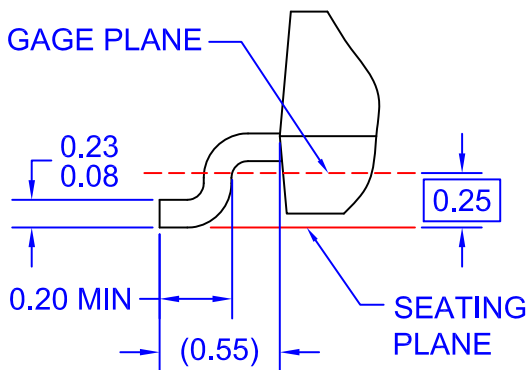
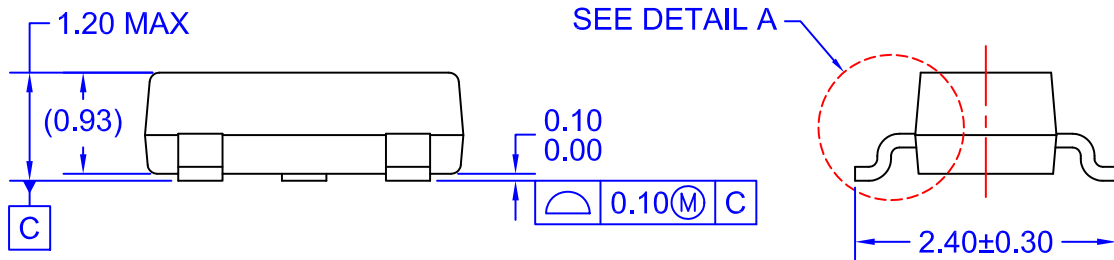
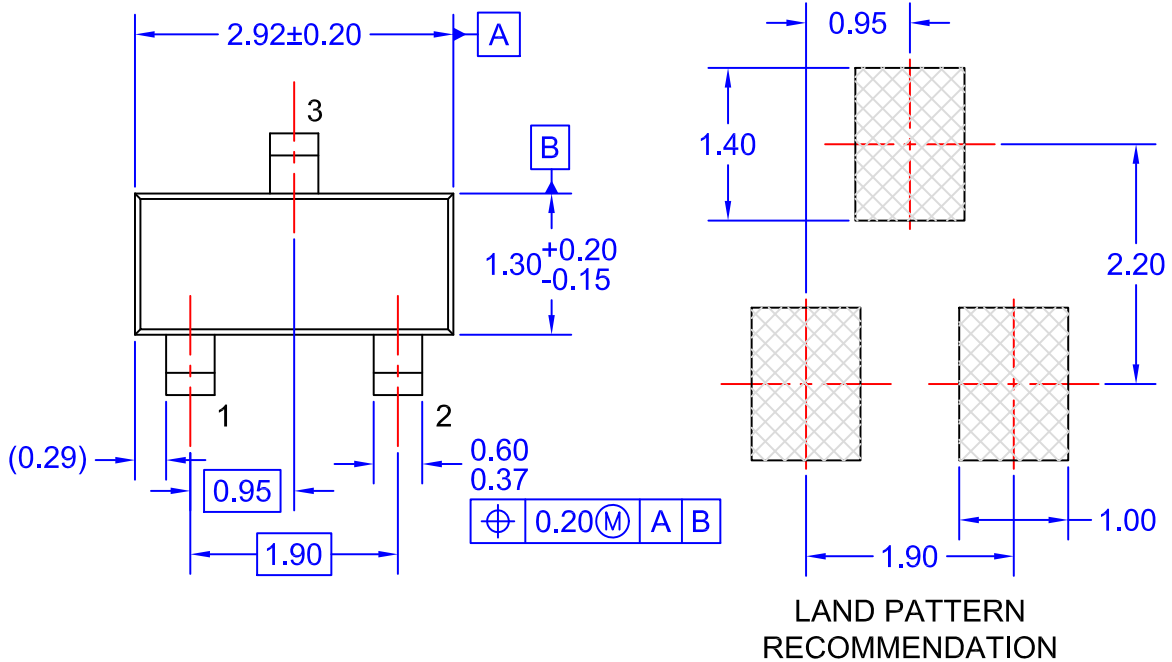

Figure 19. Reference Input Voltage vs. Ambient Temperature

LM431SA, LM431SB, LM431SC

PACKAGE DIMENSIONS

SOT-23
CASE 318BM
ISSUE O



DETAIL A
SCALE: 2X

NOTES: UNLESS OTHERWISE SPECIFIED

- A) REFERENCE JEDEC REGISTRATION TO-236, VARIATION AB, ISSUE H.
- B) ALL DIMENSIONS ARE IN MILLIMETERS.
- C) DIMENSIONS ARE INCLUSIVE OF BURRS, MOLD FLASH AND TIE BAR EXTRUSIONS.
- D) DIMENSIONING AND TOLERANCING PER ASME Y14.5M - 2009.

LM431SA, LM431SB, LM431SC

PACKAGE DIMENSIONS

SOT-23FL
CASE 419BD
ISSUE O

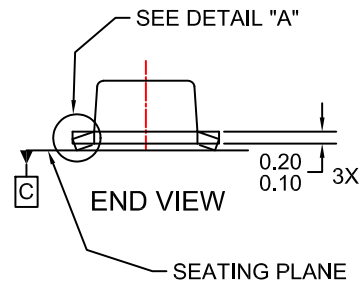
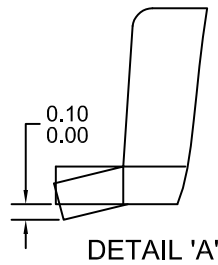
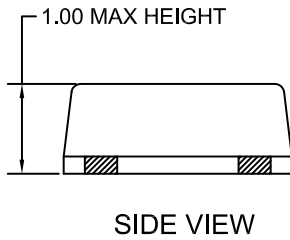
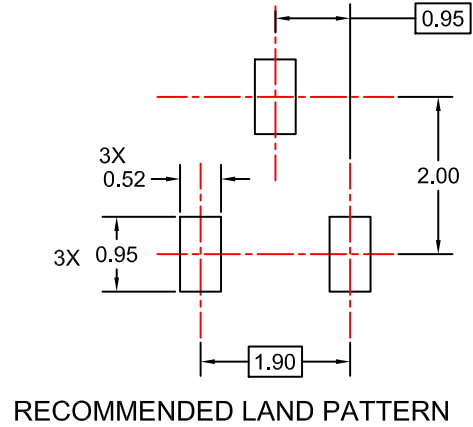
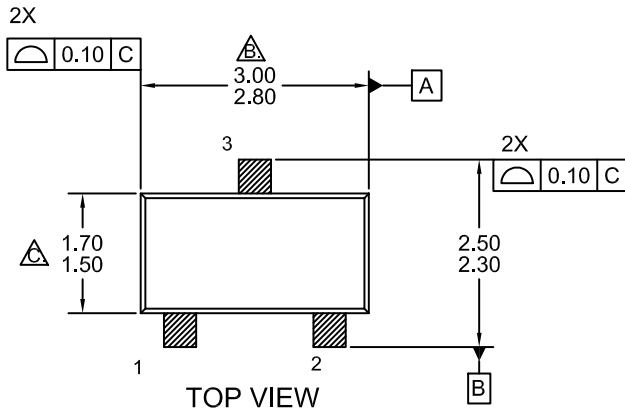

NOTES:

- A. ALL DIMENSIONS ARE IN MILLIMETERS.
- △ DIMENSION DOES NOT INCLUDE MOLD FLASH, PROTRUSIONS OR GATE BURRS. MOLD FLASH, PROTRUSIONS OR GATE BURRS SHALL NOT EXCEED 0.15mm PER END.
- ⊕ DIMENSION DOES NOT INCLUDE INTERLEAD FLASH OR PROTRUSION. INTERLEAD FLASH OR PROTRUSION SHALL NOT EXCEED 0.15mm PER SIDE.
- D. DIMENSIONS △ AND ⊕ ARE DETERMINED AT THE OUTMOST EXTREMES OF THE PLASTIC BODY EXCLUSIVE OF MOLD FLASH, TIE BAR BURRS, GATE BURRS AND INTERLEAD FLASH. BUT INCLUDING ANY MISMATCH BETWEEN THE TOP AND BOTTOM OF THE PLASTIC BODY.
- E. TERMINAL NUMBERS ARE SHOWN FOR REFERENCE ONLY.
- △ THESE DIMENSIONS APPLY TO THE FLAT SECTION OF THE LEAD BETWEEN 0.08mm AND 0.15mm FROM THE LEAD TIP.
- G. LANDPATTERN RECOMMENDATION PER IPC SOTFL95P240X100-4N (ADAPTED TO 3LD)

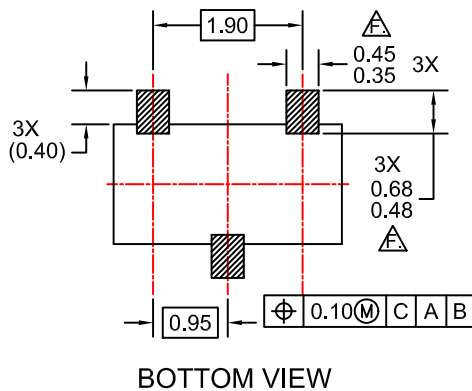

LM431SA, LM431SB, LM431SC

PACKAGE DIMENSIONS

SOT-89 3 LEAD
CASE 528AH
ISSUE O

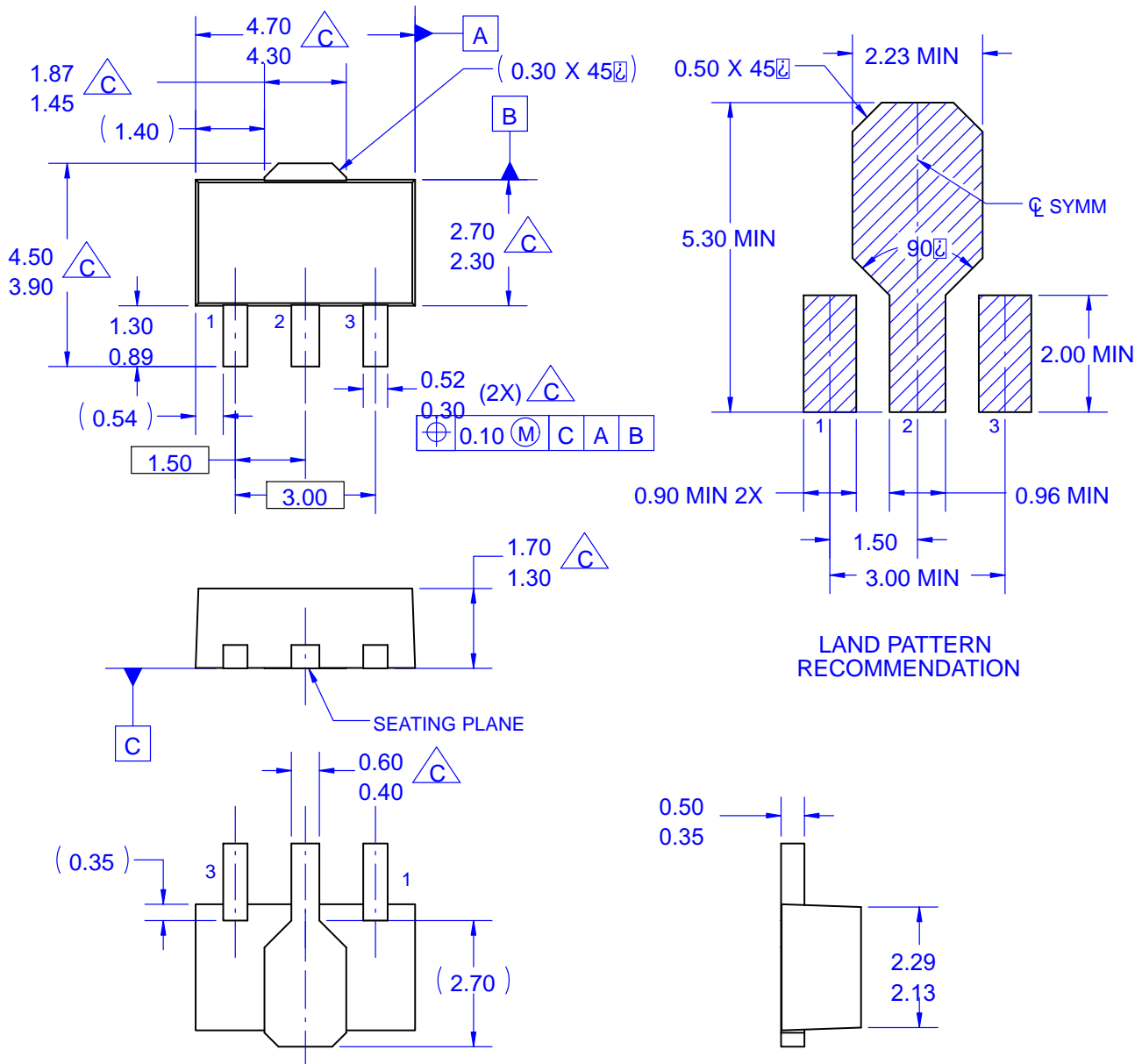

NOTES: UNLESS OTHERWISE SPECIFIED.

A. REFERENCE TO JEDEC TO-243 VARIATION AA.
B. ALL DIMENSIONS ARE IN MILLIMETERS.

(C) DOES NOT COMPLY JEDEC STANDARD VALUE.
D. DIMENSIONS ARE EXCLUSIVE OF BURRS,
MOLD FLASH AND TIE BAR PROTRUSION.
E. DIMENSION AND TOLERANCE AS PER ASME
Y14.5-1994.

LM431SA, LM431SB, LM431SC

ON Semiconductor and  are trademarks of Semiconductor Components Industries, LLC dba ON Semiconductor or its subsidiaries in the United States and/or other countries. ON Semiconductor owns the rights to a number of patents, trademarks, copyrights, trade secrets, and other intellectual property. A listing of ON Semiconductor's product/patent coverage may be accessed at www.onsemi.com/site/pdf/Patent-Marking.pdf. ON Semiconductor reserves the right to make changes without further notice to any products herein. ON Semiconductor makes no warranty, representation or guarantee regarding the suitability of its products for any particular purpose, nor does ON Semiconductor assume any liability arising out of the application or use of any product or circuit, and specifically disclaims any and all liability, including without limitation special, consequential or incidental damages. Buyer is responsible for its products and applications using ON Semiconductor products, including compliance with all laws, regulations and safety requirements or standards, regardless of any support or applications information provided by ON Semiconductor. "Typical" parameters which may be provided in ON Semiconductor data sheets and/or specifications can and do vary in different applications and actual performance may vary over time. All operating parameters, including "Typicals" must be validated for each customer application by customer's technical experts. ON Semiconductor does not convey any license under its patent rights nor the rights of others. ON Semiconductor products are not designed, intended, or authorized for use as a critical component in life support systems or any FDA Class 3 medical devices or medical devices with a same or similar classification in a foreign jurisdiction or any devices intended for implantation in the human body. Should Buyer purchase or use ON Semiconductor products for any such unintended or unauthorized application, Buyer shall indemnify and hold ON Semiconductor and its officers, employees, subsidiaries, affiliates, and distributors harmless against all claims, costs, damages, and expenses, and reasonable attorney fees arising out of, directly or indirectly, any claim of personal injury or death associated with such unintended or unauthorized use, even if such claim alleges that ON Semiconductor was negligent regarding the design or manufacture of the part. ON Semiconductor is an Equal Opportunity/Affirmative Action Employer. This literature is subject to all applicable copyright laws and is not for resale in any manner.

PUBLICATION ORDERING INFORMATION

LITERATURE FULFILLMENT:

Literature Distribution Center for ON Semiconductor
19521 E. 32nd Pkwy, Aurora, Colorado 80011 USA
Phone: 303-675-2175 or 800-344-3860 Toll Free USA/Canada
Fax: 303-675-2176 or 800-344-3867 Toll Free USA/Canada
Email: orderlit@onsemi.com

N. American Technical Support: 800-282-9855 Toll Free
USA/Canada
Europe, Middle East and Africa Technical Support:
Phone: 421 33 790 2910

ON Semiconductor Website: www.onsemi.com

Order Literature: <http://www.onsemi.com/orderlit>





For additional information, please contact your local Sales Representative

Looking for pricing, stock, or lifecycle information?

Click below to explore more details on WIN SOURCE:

-  [View LM431SCCMLX on WIN SOURCE](#)
-  [Fairchild/ON Semiconductor Information](#)

Optimize Your Supply Chain with WIN SOURCE Solutions

-  Global Sourcing Solution
-  Obsolete Management
-  Cost Control Management
-  Shortage Management
-  Alternative Solution
-  Excess Inventory Management