



**THE DATASHEET OF
LM97593VH/NOPB**



LM97593 Dual ADC / Digital Tuner / AGC

Check for Samples: [LM97593](#)

FEATURES

- **100% Software Compatible with the CLC5903**
- **Pin Compatible with the CLC5903 Except for the Analog Input and Reference Section**
- **123 dB Dynamic Range with CLC5526 DVGA (200kHz)**
- **On-chip Precision Reference**
- **User Programmable AGC with Enhanced Power Detector**
- **Channel Filters Include a Fourth Order CIC Followed by 21-tap and 63-tap Symmetric FIRs**
- **Flexible Output Formats**
- **Serial and Parallel Output Ports**
- **JTAG Boundary Scan**
- **8-bit Microprocessor Interface**
- **128 pin PQFP**

APPLICATIONS

- **Cellular Basestations**
- **GSM / GPRS / EDGE / GSM Phase 2 Receivers**
- **Satellite Receivers**
- **Wireless Local Loop Receivers**
- **Digital Communications**

KEY SPECIFICATIONS

- **Internal ADC Resolution: 12 Bits**
- **Sample Rate: 65 MSPS**
- **SNR ($f_{IN} = 250\text{MHz}$, 11-bit, Nyquist): 62 dBFS (typ)**
- **SNR ($f_{IN} = 250\text{MHz}$, 200kHz): 83 dBFS (typ)**
- **SFDR ($f_{IN} = 250\text{MHz}$, 11-bit, Nyquist): 68 dBFS (typ)**
- **Full Power Bandwidth: 650 MHz (typ)**
- **Power Consumption: (65MSPS) 560 mW (typ)**

DESCRIPTION

The LM97593 Dual ADC / Digital Tuner / AGC IC is a two channel digital downconverter (DDC) with integrated 12-bit analog-to-digital converters (ADCs) and automatic gain control (AGC). The LM97593 further enhances TI's Diversity Receiver Chipset (DRCS) by integrating a wide-bandwidth dual ADC core with the DDC. The complete DRCS includes one LM97593 Dual ADC / Digital Tuner / AGC and two CLC5526 digitally controlled variable gain amplifiers (DVGAs). This system allows direct IF sampling of signals up to 300MHz for enhanced receiver performance and reduced system costs. A block diagram for a DRCS-based narrowband communications system is shown in [Figure 1](#).

The LM97593 offers high dynamic range digital tuning and filtering based on hard-wired digital signal processing (DSP) technology. Each channel has independent tuning, phase offset, filter coefficients, and gain settings. Channel filtering is performed by a series of three filters. The first is a 4-stage Cascaded Integrator Comb (CIC) filter with a programmable decimation ratio from 8 to 2048. Next there are two symmetric FIR filters, a 21-tap and a 63-tap, both with independent programmable coefficients. The first FIR filter decimates the data by 2, the second FIR decimates by either 2 or 4. Channel filter bandwidth at 52MSPS ranges from $\pm 650\text{kHz}$ down to $\pm 1.3\text{kHz}$. At 65MSPS, the maximum bandwidth increases to $\pm 812\text{kHz}$.

The LM97593's AGC controller monitors the ADC output and controls the ADC input signal level by adjusting the DVGA setting, AGC threshold, deadband+hysteresis, and the loop time constant are user defined. Total dynamic range of greater than 123dB full-scale signal to noise in a 200kHz bandwidth can be achieved with the Diversity Receiver Chipset.



Please be aware that an important notice concerning availability, standard warranty, and use in critical applications of Texas Instruments semiconductor products and disclaimers thereto appears at the end of this data sheet.

All trademarks are the property of their respective owners.

Block Diagram 1

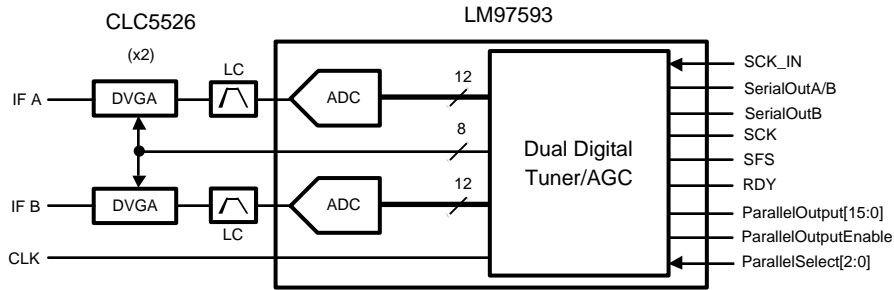

Figure 1. Diversity Receiver Chipset Block Diagram

Connection Diagram

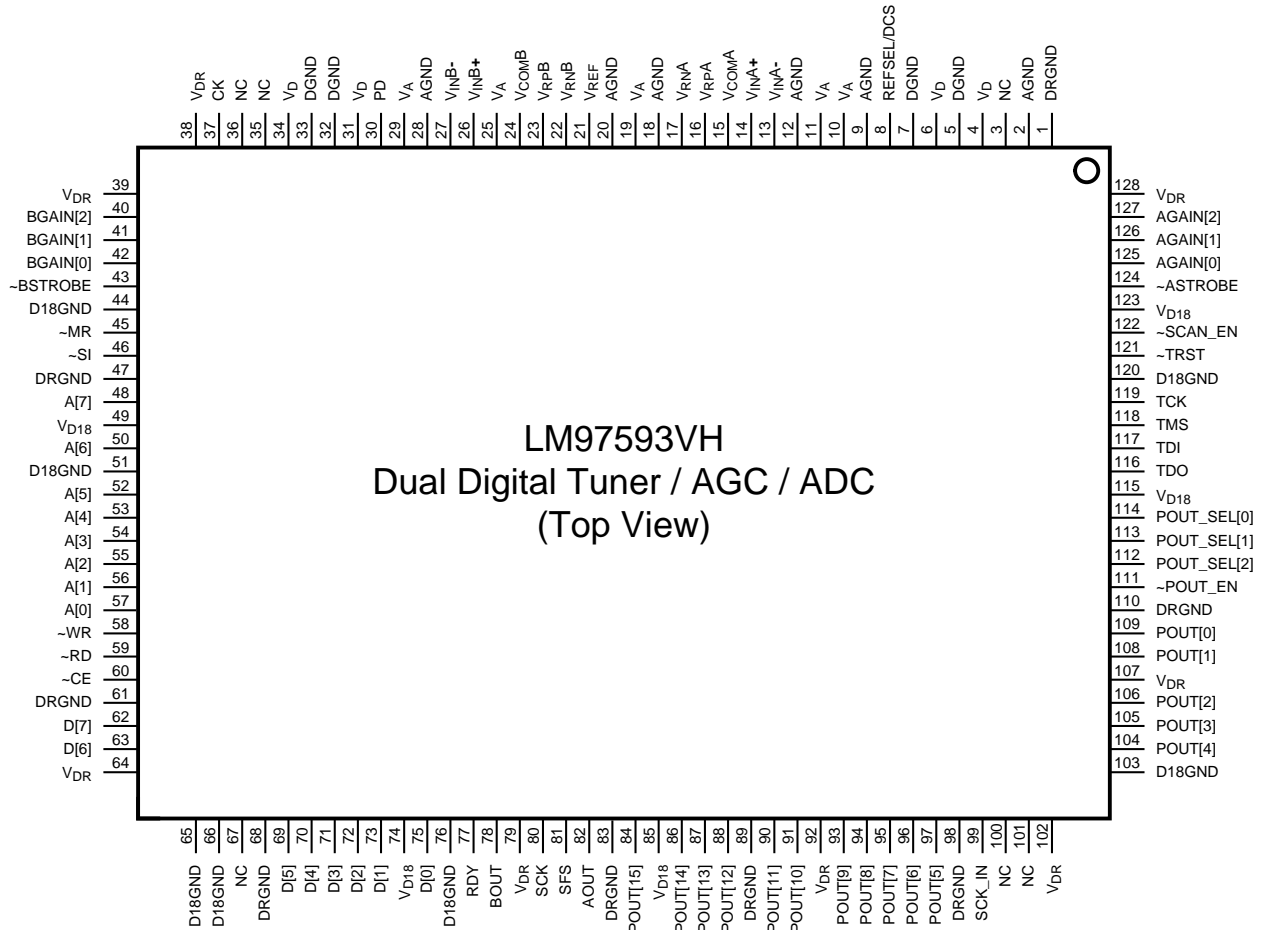

Figure 2. LM97593VH PQFP Pinout

Block Diagram 2

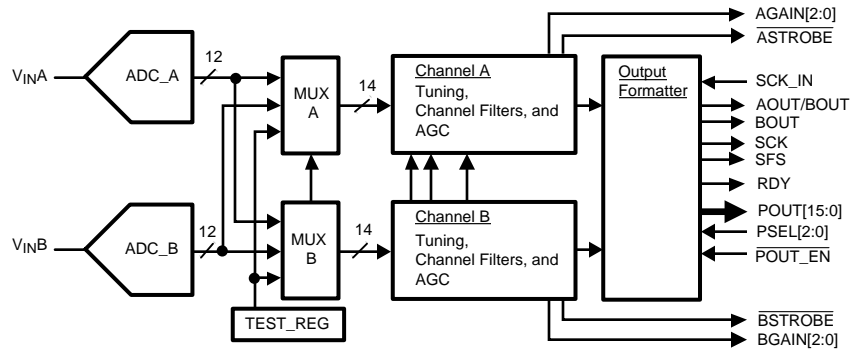

Figure 3. LM97593 Block Diagram

PIN DESCRIPTIONS AND EQUIVALENT CIRCUITS

Pin No.	Symbol	Equivalent Circuit	Description
ANALOG I/O			
13 27	V _{INA-} V _{INB-}	Analog Input	Negative differential input signal for the 'A' channel Negative differential input signal for the 'B' channel
14 26	V _{INA+} V _{INB+}	Analog Input	Positive differential input signal for the 'A' channel Positive differential input signal for the 'B' channel
21	V _{REF}	Control / Analog Input	Reference Select Pin / External Reference Voltage Input Input differential full scale swing = 2 * V _{REF} V _{REF} = V _A to V _A - 0.3V: Reference Voltage = 1.0 V (Internal) V _{REF} = 0.8V to 1.5V: Reference Voltage = V _{REF} (External)
15 24	V _{COMA} V _{COMB}	Analog Output	Common Mode reference voltage for the 'A' channel Common Mode reference voltage for the 'B' channel These pins may be loaded to 1 mA for use as temperature stable 1.5V references.
16 23	V _{RPA} V _{RPB}	Analog Output	Upper reference voltage for the 'A' channel Upper reference voltage for the 'B' channel
17 22	V _{RNA} V _{RNB}	Analog Output	Lower reference voltage for the 'A' channel Lower reference voltage for the 'B' channel
8	REFSEL/DCS	Control Input	This is a three-state pin. V _{COM} = V _{COMA} or V _{COMB} . REFSEL/DCS = AGND: the internal reference is enabled and duty cycle correction is applied to the ADC input clock (CK). REFSEL/DCS = V _{COM} : the internal reference is enabled and no duty cycle correction is applied to the ADC input clock (CK). REFSEL/DCS = V _A : DCS is on, the internal reference is disabled. Apply A 0.8-1.2V external reference to the V _{REF} pin.
DIGITAL I/O			
30	PD	Input	POWER DOWN, when high both ADCs are powered down, when low, both ADCs are enabled
45	MR	Input	MASTER RESET, <i>Active low</i> Resets all registers within the chip. ASTROBE and BSTROBE are asserted during MR .
82 78	AOUT BOUT	Output	SERIAL OUTPUT DATA, <i>Active high</i> The 2's complement serial output data is transmitted on these pins, MSB first. The output bits change on the rising edge of SCK (falling edge if SCK_POL=1) and should be captured on the falling edge of SCK (rising if SCK_POL=1). These pins are tri-stated at power up and are enabled by the SOUT_EN control register bit. See Figure 13 and Figure 75 timing diagrams. In Debug Mode AOUT=DEBUG[1] , BOUT=DEBUG[0] .
127:125 40:42	AGAIN[2:0] BGAIN[2:0]	Output	OUTPUT DATA TO DVGA, <i>Active high</i> 3 bit bus that sets the gain of the DVGA determined by the AGC circuit.
124 43	ASTROBE BSTROBE	Output	DVGA STROBE, <i>Active low</i> Strobes the data into the DVGA. See Figure 7 and Figure 82 timing diagrams.

PIN DESCRIPTIONS AND EQUIVALENT CIRCUITS (continued)

Pin No.	Symbol	Equivalent Circuit	Description
80	SCK	Output	SERIAL DATA CLOCK, <i>Active high or low</i> The serial data is clocked out of the chip by this clock. The active edge of the clock is user programmable. This pin is tri-stated at power up and is enabled by the SOUT_EN control register bit. See Figure 13 and Figure 75 timing diagrams. In Debug Mode outputs an appropriate clock for the debug data. If RATE=0 the input CK duty cycle will be reflected to SCK .
99	SCK_IN	Input	SERIAL DATA CLOCK INPUT, <i>Active high or low</i> Data bits from a serial daisy-chain slave are clocked into a serial daisy-chain master on the falling edge of SCK_IN (rising if SCK_POL=1 on the slave). Tie low if not used.
81	SFS	Output	SERIAL FRAME STROBE, <i>Active high or low</i> The serial word strobe. This strobe delineates the words within the serial output streams. This strobe is a pulse at the beginning of each serial word (PACKED=0) or each serial word I/Q pair (PACKED=1). The polarity of this signal is user programmable. This pin is tri-stated at power up and is enabled by the SOUT_EN control register bit. See Figure 13 and Figure 75 timing diagrams. In Debug Mode SFS=DEBUG[2] .
84, 86:88, 90, 91, 93:97, 104:106, 108, 109	POUT[15:0]	Output	PARALLEL OUTPUT DATA, <i>Active high</i> The output data is transmitted on these pins in parallel format. The POUT_SEL[2:0] pins select one of eight 16-bit output words. The POUT_EN pin enables these outputs. POUT[15] is the MSB. In Debug Mode POUT[15:0]=DEBUG[19:4] .
112:114	POUT_SEL[2:0]	Input	PARALLEL OUTPUT DATA SELECT, <i>Active high</i> The 16-bit output word is selected with these 3 pins. Not used in Debug Mode. For a serial daisy-chain master, POUT_SEL[2:0] become inputs from the slave: POUT_SEL[2]=SFS_{SLAVE} , POUT_SEL[1]=BOUT_{SLAVE} , and POUT_SEL[0]=AOUT_{SLAVE} . Tie low if not used.
111	$\overline{\text{POUT_EN}}$	Input	PARALLEL OUTPUT ENABLE. <i>Active low</i> This pin enables the chip to output the selected output word on the POUT[15:0] pins. Not used in Debug Mode. Tie high if not used.
77	RDY	Output	READY FLAG, <i>Active high or low</i> The chip asserts this signal to identify the beginning of an output sample period (OSP). The polarity of this signal is user programmable. This signal is typically used as an interrupt to a DSP chip, but can also be used as a start pulse to dedicated circuitry. This pin is active regardless of the state of SOUT_EN. In Debug Mode RDY=DEBUG[3] .
37	CK	Input	INPUT CLOCK. <i>Active high</i> The clock input to the chip. The V_{IN}A and V_{IN}B analog input signals are sampled on the rising edge of this signal. SI is clocked into the chip on the rising edge of CK .
46	$\overline{\text{SI}}$	Input	SYNC IN. <i>Active low</i> The sync input to the chip. The decimation counters, dither, and NCO phase can be synchronized by SI . This sync is clocked into the chip on the rising edge of CK . Tie this pin high if external sync is not required. All sample data is flushed by SI . To properly initialize the DVGA ASTROBE and BSTROBE are asserted during SI .
62, 63, 69:73, 75	D[7:0]	Input/Output	DATA BUS. <i>Active high</i> This is the 8 bit control data I/O bus. Control register data is loaded into the chip or read from the chip through these pins. The chip will only drive output data on these pins when CE is low, RD is low, and WR is high.
48, 50, 52:57	A[7:0]	Input	ADDRESS BUS. <i>Active high</i> These pins are used to address the control registers within the chip. Each of the control registers within the chip are assigned a unique address. A control register can be written to or read from by setting A[7:0] to the register's address and setting CE , RD , and WR appropriately.
59	$\overline{\text{RD}}$	Input	READ ENABLE. <i>Active low</i> This pin enables the chip to output the contents of the selected register on the D[7:0] pins when CE is also low.
58	$\overline{\text{WR}}$	Input	WRITE ENABLE. <i>Active low</i> This pin enables the chip to write the value on the D[7:0] pins into the selected register when CE is also low. This pin can also function as RD/CE if RD is held low. See Figure 15 for details.

PIN DESCRIPTIONS AND EQUIVALENT CIRCUITS (continued)

Pin No.	Symbol	Equivalent Circuit	Description
60	$\overline{\text{CE}}$	Input	CHIP ENABLE. <i>Active low</i> This control strobe enables the read or write operation. The contents of the register selected by A[7:0] will be output on D[7:0] when $\overline{\text{RD}}$ is low and $\overline{\text{CE}}$ is low. If $\overline{\text{WR}}$ is low and $\overline{\text{CE}}$ is low, then the selected register will be loaded with the contents of D[7:0] .
116	TDO	Output	TEST DATA OUT. <i>Active high</i>
117	TDI	Input	TEST DATA IN. <i>Active high with pull-up</i>
118	TMS	Input	TEST MODE SELECT. <i>Active high with pull-up</i>
119	TCK	Input	TEST CLOCK. <i>Active high</i> . Tie low if JTAG is not used.
121	$\overline{\text{TRST}}$	Input	TEST RESET. <i>Active low with pull-up</i> Asynchronous reset for TAP controller. Tie low or to $\overline{\text{MR}}$ if JTAG is not used.
122	$\overline{\text{SCAN_EN}}$	Input	SCAN ENABLE. <i>Active low with pull-up</i> Enables access to internal scan registers. Tie high. Used for manufacturing test only!
Digital Power Supplies			
38, 39, 64, 79, 92, 102, 107, 128	V _{DR}	DDC Output Driver Power	I/O Power Supply, 3.3V nominal. Quantity 8.
1, 47, 61, 68, 83, 89, 98, 110	DRGND	DDC Output Driver Ground	I/O Ground Return. Quantity 8.
49, 74, 85, 115, 123	V _{D18}	DDC Core Power	DSP Digital Core Power Supply, 1.8V nominal. Quantity 5.
49, 74, 85, 115, 123	V _{D18}	DDC Core Power	DSP Digital Core Power Supply, 1.8V nominal. Quantity 5.
44, 51, 65, 66, 76, 103, 120	D18GND	DDC Core Ground	DSP Digital Core Ground Return. Quantity 7.
4, 6, 31, 34	V _D	ADC Digital Power	ADC Digital Logic Power Supply, 3.3V nominal. Quantity 4.
5, 7, 32, 33	DGND	ADC Digital Ground	ADC Digital Logic Ground Return. Quantity 4.
Analog Power Supplies			
10, 11, 19, 25, 29	V _A	ADC Analog Power	ADC Analog Power Supply, 3.3V nominal. Quantity 5.
2, 9, 12, 18, 20, 28	AGND	ADC Analog Ground	ADC Analog Ground Return. Quantity 6.
Unconnected Pins			
3, 35, 36, 67, 100, 101	NC	NC	Not Connected. These pins should be left floating.



These devices have limited built-in ESD protection. The leads should be shorted together or the device placed in conductive foam during storage or handling to prevent electrostatic damage to the MOS gates.

Absolute Maximum Ratings⁽¹⁾⁽²⁾⁽³⁾

ADC Analog, Digital and IO Supply Voltages (V_A , V_D and V_{DR})	-0.3V to 4.2V	
Difference between V_A , V_D , and V_{DR}	≤ 100 mV	
Positive Core Supply Voltage (V_{D18})	-0.3V to 2.35V	
Voltage on Any Input or Output Pin (Not to exceed 4.2V)	-0.3V to ($V_{DR} + 0.3V$)	
Input Current at Any Pin other than Supply Pins ⁽⁴⁾	± 5 mA	
Package Input Current ⁽⁴⁾	± 50 mA	
Max Junction Temp (T_J)	+125°C	
Thermal Resistance (θ_{JA})	39°C/W	
Package Dissipation at $T_A = 25^\circ\text{C}$ ⁽⁵⁾	3.2W	
ESD Susceptibility ⁽⁶⁾	Human Body Model (1.5k Ω , 100pF)	2000 V
	Machine Model (0 Ω , 200pF)	200 V
Charge Device Model	750 V	
Storage Temperature	-65°C to +150°C	

- (1) All voltages are measured with respect to GND = AGND = DGND = DRGND = 0V, unless otherwise specified.
- (2) Absolute Maximum Ratings indicate limits beyond which damage to the device may occur. Operating Ratings indicate conditions for which the device is ensured to be functional, but do not ensure specific performance limits. For ensured specifications and test conditions, see the Electrical Characteristics. The ensured specifications apply only for the test conditions listed. Some performance characteristics may degrade when the device is not operated under the listed test conditions. Operation of the device beyond the maximum Operating Ratings is not recommended.
- (3) If Military/Aerospace specified devices are required, please contact the Texas Instruments Sales Office/Distributors for availability and specifications.
- (4) When the input voltage at any pin exceeds the power supplies (that is, $V_{IN} < \text{AGND}$, or $V_{IN} > V_A$), the current at that pin should be limited to ± 25 mA. The ± 50 mA maximum package input current rating limits the number of pins that can safely exceed the power supplies with an input current of ± 25 mA to two.
- (5) The maximum allowable power dissipation is dictated by $T_{J,max}$, the junction-to-ambient thermal resistance, (θ_{JA}), and the ambient temperature, (T_A), and can be calculated using the formula $P_{D,max} = (T_{J,max} - T_A) / \theta_{JA}$. The values for maximum power dissipation listed above will be reached only when the device is operated in a severe fault condition (e.g. when input or output pins are driven beyond the power supply voltages, or the power supply polarity is reversed). Such conditions should always be avoided.
- (6) Human Body Model is 100 pF discharged through a 1.5 k Ω resistor. Machine Model is 220 pF discharged through 0 Ω .

Operating Ratings⁽¹⁾⁽²⁾

Soldering process must comply with Texas Instrument's Reflow Temperature Profile specifications. Refer to http://www.ti.com/packaging ⁽³⁾	
Operating Temperature Range	$-40^\circ\text{C} \leq T_A \leq +85^\circ\text{C}$
ADC Analog, Digital and IO Supply Voltages (V_A , V_D and V_{DR})	+3.0V to +3.6V
Digital Core Supply Voltage (V_{D18})	+1.6V to +2.0V
Difference Between AGND, DGND, DRGND and D18GND	≤ 100 mV
Voltage on Any Input or Output Pin	0V to +3.3V
V_{CM}	1.0V to 2.0V
Clock Duty Cycle	30% to 70 %

- (1) Absolute Maximum Ratings indicate limits beyond which damage to the device may occur. Operating Ratings indicate conditions for which the device is ensured to be functional, but do not ensure specific performance limits. For ensured specifications and test conditions, see the Electrical Characteristics. The ensured specifications apply only for the test conditions listed. Some performance characteristics may degrade when the device is not operated under the listed test conditions. Operation of the device beyond the maximum Operating Ratings is not recommended.
- (2) All voltages are measured with respect to GND = AGND = DGND = DRGND = 0V, unless otherwise specified.
- (3) Reflow temperature profiles are different for lead-free and non-lead-free packages.

Reliability Information

Transistor Count	1.3 million
------------------	-------------

LM97593 Electrical Characteristics

Unless otherwise specified, the following specifications apply: AGND = DGND = DRGND = D18GND = 0V, $V_A = V_D = V_{DR} = +3.3V$, $V_{D18} = +1.8V$, Internal $V_{REF} = +1.0V$, $f_{CLK} = 65\text{ MHz}$, $V_{CM} = V_{COM}$, $t_R = t_F = 1\text{ ns}$, $C_L = 5\text{ pF/pin}$. The ADC's 11 most significant bits observed at the mixer output debug tap with NCO = 0Hz. Typical values are for $T_A = 25^\circ\text{C}$. **Boldface limits apply for $T_{MIN} \leq T_A \leq T_{MAX}$.** All other limits apply for $T_A = 25^\circ\text{C}$.⁽¹⁾⁽²⁾⁽³⁾

Symbol	Parameter	Conditions	Typical ⁽⁴⁾	Limits	Units (Limits)
STATIC CONVERTER CHARACTERISTICS					
	Resolution with No Missing Codes			11	Bits (min)
INL	Integral Non Linearity ⁽⁵⁾	Ramp, End Point	± 0.7	2	LSB (max)
				-2	LSB (min)
DNL	Differential Non Linearity	Ramp, End Point	± 0.3	0.85	LSB (max)
				-0.85	LSB (min)
V_{OFF}	Offset Error	-40°C to $+85^\circ\text{C}$	-4.1		LSB
REFERENCE AND ANALOG INPUT CHARACTERISTICS					
V_{CM}	Common Mode Input Voltage		1.5	1.0	V (min)
				2.0	V (max)
V_{COMA} V_{COMB}	Reference Output Voltage		1.5		V
C_{IN}	V_{IN} Input Capacitance (each pin to GND) ($V_{IN} = 1.5V_{dc} \pm 0.5V$) ⁽⁶⁾	CK LOW	8		pF
		CK HIGH	7		pF
V_{REF}	External Reference Voltage ⁽⁷⁾		1.0	0.8	V (min)
				1.2	V (max)
	Reference Input Resistance		1		M Ω

- (1) The inputs are protected as shown below. Input voltage magnitudes above V_A or below GND will not damage this device, provided current is limited per [Note \(4\)](#).

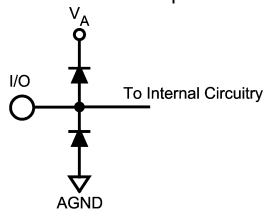

- (2) To ensure accuracy, it is required that $|V_A - V_D| \leq 100\text{ mV}$ and separate bypass capacitors are used at each power supply pin.
 (3) With the test condition for $V_{REF} = +1.0V$ ($2V_{P-P}$ differential input), the 12-Bit LSB is $488\ \mu\text{V}$.
 (4) Typical figures are at $T_A = 25^\circ\text{C}$ and represent most likely parametric norms at the time of product characterization. The typical specifications are not ensured. Test Limits are specified to TI's AOQL (Average Outgoing Quality Level).
 (5) Integral Non Linearity is defined as the deviation of the analog value, expressed in LSBs, from the straight line that passes through positive and negative full-scale.
 (6) The input capacitance is the sum of the package/pin capacitance and the sample and hold circuit capacitance.
 (7) Optimum performance will be obtained by keeping the reference input in the 0.8V to 1.2V range. The LM4051CIM3-ADJ (SOT-23 package) is recommended for external reference applications.

LM97593 Electrical Characteristics (continued)

Unless otherwise specified, the following specifications apply: AGND = DGND = DRGND = D18GND = 0V, $V_A = V_D = V_{DR} = +3.3V$, $V_{D18} = +1.8V$, Internal $V_{REF} = +1.0V$, $f_{CLK} = 65$ MHz, $V_{CM} = V_{COM}$, $t_R = t_F = 1$ ns, $C_L = 5$ pF/pin. The ADC's 11 most significant bits observed at the mixer output debug tap with NCO = 0Hz. Typical values are for $T_A = 25^\circ C$. **Boldface limits apply for $T_{MIN} \leq T_A \leq T_{MAX}$** . All other limits apply for $T_A = 25^\circ C$.⁽¹⁾⁽²⁾⁽³⁾

Symbol	Parameter	Conditions	Typical ⁽⁴⁾	Limits	Units (Limits)
DYNAMIC CONVERTER CHARACTERISTICS					
FPBW	Full Power Bandwidth		650		MHz
SNR	Signal-to-Noise Ratio	$f_{IN} = 20MHz, V_{IN} = -3dBFS$	66.2		dBFS
		$f_{IN} = 249MHz, V_{IN} = -3dBFS$	63.7		dBFS
		$f_{IN} = 249MHz, V_{IN} = -9dBFS$	63.9	62.2	dBFS (min)
SINAD	Signal-to-Noise and Distortion	$f_{IN} = 20MHz, V_{IN} = -3dBFS$	62.8		dBFS
		$f_{IN} = 249MHz, V_{IN} = -3dBFS$	62.0		dBFS
		$f_{IN} = 249MHz, V_{IN} = -9dBFS$	63.4	60.4	dBFS (min)
ENOB	Effective Number of Bits (Relative to Full Scale)	$f_{IN} = 20MHz, V_{IN} = -3dBFS$	10.6		Bits
		$f_{IN} = 249MHz, V_{IN} = -3dBFS$	10.0		Bits
		$f_{IN} = 249MHz, V_{IN} = -9dBFS$	10.3		Bits (min)
THD	Total Harmonic Distortion	$f_{IN} = 20MHz, V_{IN} = -3dBFS$	-77.1		dBc
		$f_{IN} = 249MHz, V_{IN} = -3dBFS$	-57.9		dBc
		$f_{IN} = 249MHz, V_{IN} = -9dBFS$	-64.6	-54.1	dBc (max)
H2	Second Harmonic Distortion	$f_{IN} = 20MHz, V_{IN} = -3dBFS$	-82.7		dBc
		$f_{IN} = 249MHz, V_{IN} = -3dBFS$	-59.9		dBc
		$f_{IN} = 249MHz, V_{IN} = -9dBFS$	-67.3	-59.3	dBc (max)
H3	Third Harmonic Distortion	$f_{IN} = 20MHz, V_{IN} = -3dBFS$	-91.7		dBc
		$f_{IN} = 249MHz, V_{IN} = -3dBFS$	-69.0		dBc
		$f_{IN} = 249MHz, V_{IN} = -9dBFS$	-72.5	-56.8	dBc (min)
SFDR	Spurious Free Dynamic Range	$f_{IN} = 20MHz, V_{IN} = -3dBFS$	79.7		dBFS
		$f_{IN} = 249MHz, V_{IN} = -3dBFS$	68.0		dBFS (min)
		$f_{IN} = 249MHz, V_{IN} = -9dBFS$	76.3	67.0	dBFS
IMD	Intermodulation Distortion	$f_{1IN} = 246MHz, V_{IN} = -15dBFS$ $f_{2IN} = 250MHz, V_{IN} = -15dBFS$ ($f_{1IN} + f_{2IN} = -9dBFS$)	-77.5		dBFS
		Dynamic Gain Error	-3 dBFS reference, -50dBFS target	± 1.3	± 2
INTERCHANNEL CHARACTERISTICS					
	Channel - Channel Offset Match	10 MHz -1dBFS driven	± 0.2		%FS
	Channel - Channel Gain Match	10 MHz -1dBFS driven	± 0.4		%FS
	Crosstalk (AGC fixed at 0dB gain, with AGC operating the crosstalk will improve at the output)	249MHz -3dBFS driven channel, 50 Ω termination measured channel	60(+42) ⁽⁸⁾		dBc
CIC OUTPUT CHARACTERISTICS					
SNR	Signal-to-Noise Ratio	CIC Decimation = 8, NCO = 11.1MHz (248.9MHz @65MSPS aliases to 11.1 MHz), $f_{IN} = 249MHz$ at -3dBFS, signal observed at F1 In Debug tap	68.6	66.1	dBFS
SINAD	Signal-to-Noise and Distortion		68.5	66.1	dBFS
SFDR	Spurious Free Dynamic Range		75.1	70.3	dBc
DDC OUTPUT CHARACTERISTICS					
SNR	Signal-to-Noise Ratio	GSM Filter set, 200kHz channel BW, NCO = 11.1MHz (248.9MHz @52MSPS aliases to 11.1 MHz), $f_S = 52MSPS$, $f_{IN} = 249MHz$ at -9dBFS	82(+42) ⁽⁸⁾		dBFS
SINAD	Signal-to-Noise and Distortion		73		dBc
SFDR	Spurious Free Dynamic Range		90		dBc

(8) (+x) indicates the additional dynamic range provided by the AGC. The DVGA in front of the LM97593 provides 42 dB of gain adjustment.

LM97593 Electrical Characteristics (continued)

Unless otherwise specified, the following specifications apply: AGND = DGND = DRGND = D18GND = 0V, $V_A = V_D = V_{DR} = +3.3V$, $V_{D18} = +1.8V$, Internal $V_{REF} = +1.0V$, $f_{CLK} = 65\text{ MHz}$, $V_{CM} = V_{COM}$, $t_R = t_F = 1\text{ ns}$, $C_L = 5\text{ pF/pin}$. The ADC's 11 most significant bits observed at the mixer output debug tap with NCO = 0Hz. Typical values are for $T_A = 25^\circ\text{C}$. **Boldface limits apply for $T_{MIN} \leq T_A \leq T_{MAX}$** . All other limits apply for $T_A = 25^\circ\text{C}$.⁽¹⁾⁽²⁾⁽³⁾

Symbol	Parameter	Conditions	Typical ⁽⁴⁾	Limits	Units (Limits)
SNR	Signal-to-Noise Ratio	GSM Filter set, 200kHz channel BW, NCO = 11.1MHz (248.9MHz) @52MSPS aliases to 11.1 MHz, $f_S = 52\text{MSPS}$, $f_{IN} = 249\text{MHz}$ at -3dBFS	76 (+42) ₍₉₎		dBFS
SINAD	Signal-to-Noise and Distortion		74		dBc
SFDR	Spurious Free Dynamic Range		90		dBc
SNR	Signal-to-Noise Ratio	GSM Filter set, 200kHz channel BW, NCO = 11.1MHz (248.9MHz) @65MSPS aliases to 11.1 MHz, $f_S = 65\text{MSPS}$, $f_{IN} = 249\text{MHz}$ at -9dBFS	79 (+42) ₍₉₎		dBFS
SINAD	Signal-to-Noise and Distortion		71		dBc
SFDR	Spurious Free Dynamic Range		81		dBc
SNR	Signal-to-Noise Ratio	GSM Filter set, 200kHz channel BW, NCO = 11.1MHz (248.9MHz) @65MSPS aliases to 11.1 MHz, $f_S = 65\text{MSPS}$, $f_{IN} = 249\text{MHz}$ at -3dBFS	74 (+42) ₍₉₎		dBFS
SINAD	Signal-to-Noise and Distortion		71		dBc
SFDR	Spurious Free Dynamic Range		80		dBc

(9) (+x) indicates the additional dynamic range provided by the AGC. The DVGA in front of the LM97593 provides 42 dB of gain adjustment.

DC and Logic Electrical Characteristics

Unless otherwise specified, the following specifications apply: AGND = DGND = DRGND = D18GND = 0V, $V_A = V_D = V_{DR} = +3.3V$, $V_{D18} = +1.8V$, Internal $V_{REF} = +1.0V$, $f_{CLK} = 65\text{ MHz}$, $V_{CM} = V_{COM}$, $t_R = t_F = \text{TBD ns}$, $C_L = 5\text{ pF/pin}$. CIC Decimation = 48, F2 Decimation = 2. Typical values are for $T_A = 25^\circ\text{C}$. **Boldface limits apply for $T_{MIN} \leq T_A \leq T_{MAX}$** . All other limits apply for $T_A = 25^\circ\text{C}$.

Symbol	Parameter	Conditions	Typical ⁽¹⁾	Limits	Units (Limits)
V_{IL}	Voltage input low			0.7	V (max)
V_{IH}	Voltage input high			2.3	V (min)
I_{OZ}	Input current			20	μA
V_{OL}	Voltage output low ($I_{OL} = 7\text{mA}$)			0.4	V (max)
V_{OH}	Voltage output high ($I_{OH} = -7\text{mA}$)			2.4	V (min)
C_{IN}	Input capacitance			5.0	pF
POWER SUPPLY CHARACTERISTICS					
I_A	ADC Analog Supply Current	65MSPS	96	121	mA (max)
I_A	ADC Analog Supply Current	52MSPS	84		mA
I_D	ADC Digital Supply Current	65MSPS	24	28	mA (max)
I_D	ADC Digital Supply Current	52MSPS	20		mA
I_{DR}	Digital Output Supply Current ⁽²⁾	65MSPS	14	18	mA (max)
I_{DR}	Digital Output Supply Current ⁽²⁾	52MSPS	10		mA
I_{D18}	Digital Core Supply Current	65MSPS	67	78	mA (max)
I_{D18}	Digital Core Supply Current	52MSPS	53		mA
P_{D65}	Total Power Dissipation	GSM Set, 65MSPS	560	793	mW (max)
P_{D52}	Total Power Dissipation	GSM Set, 52MSPS	485		mW
PSRR	Power Supply Rejection Ratio	Rejection of Full-Scale Error with $V_A = 3.0V$ vs. $3.6V$			dB

- (1) Typical figures are at $T_A = 25^\circ\text{C}$ and represent most likely parametric norms at the time of product characterization. The typical specifications are not ensured. Test Limits are specified to TI's AOQL (Average Outgoing Quality Level).
- (2) I_{DR} is the current consumed by the switching of the output drivers and is primarily determined by load capacitance on the output pins, the supply voltage, V_{DR} , and the rate at which the outputs are switching (which is signal dependent). $I_{DR} = V_{DR}(C_0 \times f_0 + C_1 \times f_1 + \dots + C_{11} \times f_{11})$ where V_{DR} is the output driver power supply voltage, C_n is total capacitance on the output pin, and f_n is the average frequency at which that pin is toggling.

AC Electrical Characteristics

Unless otherwise specified, the following specifications apply: AGND = DGND = DRGND = D18GND = 0V, $V_A = V_D = V_{DR} = +3.3V$ ($\pm 10\%$), $V_{D18} = +1.8V$ ($\pm 10\%$), Internal $V_{REF} = +1.0V$, $f_{CLK} = 65$ MHz, $V_{CM} = V_{COM}$, $t_R = t_F = 1$ ns, $C_L = 5$ pF/pin. CIC Decimation = 48, F2 Decimation = 2. Typical values are for $T_A = 25^\circ C$. **Boldface limits apply for $T_{MIN} \leq T_A \leq T_{MAX}$.** All other limits apply for $T_A = 25^\circ C$.⁽¹⁾

Symbol	Parameter ($C_L=50pF$)	Min	Typical ⁽²⁾	Max	Units
Clock Input					
F_{CK}	Clock (CK) Frequency (Figure 6)	20		65	MHz
t_{CKDC}	CK duty cycle, DCS off (Figure 6)	40		60	%
t_{RF}	CK rise and fall times (V_{IL} to V_{IH}) (Figure 6)			2	ns
	NCO Tuning Resolution		0.02		Hz
	NCO Phase Resolution		0.005		o
Control Interface					
t_{MRA}	\overline{MR} Active Time (Figure 4)	4			CK periods
t_{MRIC}	\overline{MR} Inactive to first Control Port Access (Figure 4)	10			CK periods
t_{MRSU}	\overline{MR} Setup Time to CK (Figure 4)	6			ns
t_{MRH}	\overline{MR} Hold Time from CK (Figure 4)	2			ns
t_{SISU}	\overline{SI} Setup Time to CK (Figure 5)	6			ns
t_{SIH}	\overline{SI} Hold Time from CK (Figure 5)	2			ns
t_{SIW}	\overline{SI} Pulse Width (Figure 5)	4			CK periods
DVGA Interface					
t_{STIW}	$\overline{A BSTROBE}$ Inactive Pulse Width (Figure 7)		2		CK periods
t_{GSTB}	$\overline{A BGAIN}$ setup before $\overline{A BSTROBE}$ (Figure 7)	6			ns
Parallel Output Interface					
t_{OENV}	POUT_EN Active to POUT[15:0] Valid (Figure 9)			12	ns
t_{OENT}	POUT_EN Inactive to POUT[15:0] Tri-State (Figure 9)			10	ns
t_{SELV}	PSEL[2:0] to POUT[15:0] Valid (Figure 10)			13	ns
t_{POV}	RDY to POUT[15:0] New Value Valid (Note 5) (Figure 11)			7	ns
t_{DBG}	SCK to POUT[15:0] , RDY , SFS , AOUT , BOUT Valid (Figure 12)			4	ns
Serial Interface					
t_{SFSV}	SCK to SFS Valid (Note 3) (Figure 13)	-2	1.6	3.5	ns
t_{OV}	SCK to A BOUT Valid (Note 4) (Figure 13)	-2	1.7	3.5	ns
t_{RDYW}	RDY Pulse Width (Figure 13)		2		CK periods
t_{DCMSU}	PSEL[2:0] Setup Time to SCK_IN (Figure 8)	3	1.4		ns
t_{DCMH}	PSEL[2:0] Hold Time from SCK_IN (Figure 8)	0.5	-0.9		ns
t_{RDYV}	SCK to RDY valid (Figure 13)	-3	1.8	4	ns
JTAG Interface					
t_{JPCO}	Propagation Delay TCK to TDO (Figure 14)			25	ns
t_{JSCO}	Propagation Delay TCK to Data Out (Figure 14)			35	ns
t_{JPDZ}	Disable Time TCK to TDO (Figure 14)			25	ns
t_{JSDZ}	Disable Time TCK to Data Out (Figure 14)			35	ns
t_{JPEN}	Enable Time TCK to TDO (Figure 14)	0		25	ns
t_{JSEN}	Enable Time TCK to Data Out (Figure 14)	0		35	ns
t_{JSSU}	Setup Time Data to TCK (Figure 14)	10			ns
t_{JPSU}	Setup Time TDI , TMS to TCK (Figure 14)	10			ns
t_{JSH}	Hold Time Data to TCK (Figure 14)	45			ns
t_{JPH}	Hold Time TCK to TDI , TMS (Figure 14)	45			ns

(1) Timing specifications are tested at TTL logic levels, $V_{IL} = 0.4V$ for a falling edge and $V_{IH} = 2.4V$ for a rising edge.

(2) Typical figures are at $T_A = 25^\circ C$ and represent most likely parametric norms at the time of product characterization. The typical specifications are not ensured. Test Limits are specified to TI's AOQL (Average Outgoing Quality Level).

AC Electrical Characteristics (continued)

Unless otherwise specified, the following specifications apply: AGND = DGND = DRGND = D18GND = 0V, $V_A = V_D = V_{DR} = +3.3V (\pm 10\%)$, $V_{D18} = +1.8V (\pm 10\%)$, Internal $V_{REF} = +1.0V$, $f_{CLK} = 65\text{ MHz}$, $V_{CM} = V_{COM}$, $t_R = t_F = 1\text{ ns}$, $C_L = 5\text{ pF/pin}$. CIC Decimation = 48, F2 Decimation = 2. Typical values are for $T_A = 25^\circ\text{C}$. **Boldface limits apply for $T_{MIN} \leq T_A \leq T_{MAX}$** . All other limits apply for $T_A = 25^\circ\text{C}$.⁽¹⁾

Symbol	Parameter ($C_L=50\text{pF}$)	Min	Typical ⁽²⁾	Max	Units
t_{JCH}	TCK Pulse Width High (Figure 14)	50			ns
t_{JCL}	TCK Pulse Width Low (Figure 14)	40			ns
$JTAG_{FMAX}$	TCK Maximum Frequency (Figure 14)			10	MHz
Microprocessor Interface					
t_{CSU}	Control Setup before the controlling signal goes low (Figure 15)	5			ns
t_{CHD}	Control hold after the controlling signal goes high (Figure 15)	5			ns
t_{CSPW}	Controlling strobe pulse width (Write) (Figure 15)	30			ns
t_{CDLY}	Control output delay controlling signal low to D (Read) (Figure 15)			30	ns
t_{CZ}	Control tri-state delay after controlling signal high (Figure 15)			20	ns

DDC Timing Diagrams

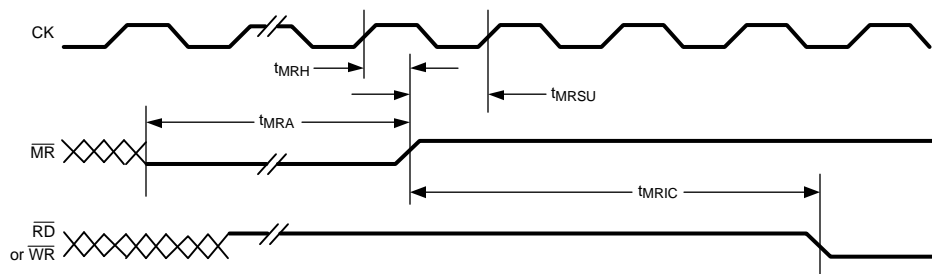

Figure 4. LM97593 Master Reset Timing

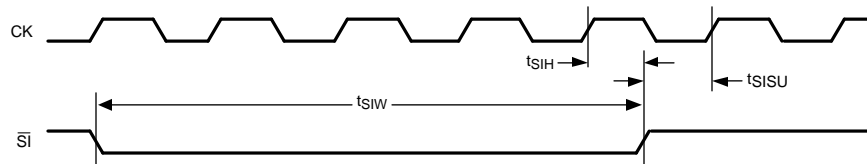

Figure 5. LM97593 Synchronization Input (SI) Timing

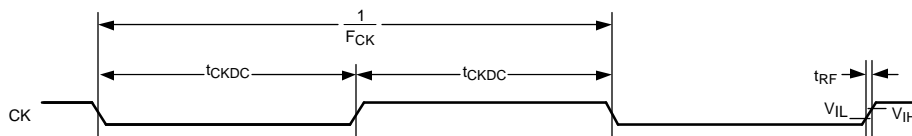

Figure 6. LM97593 Clock Timing

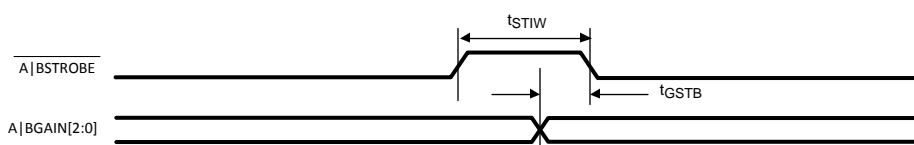

Figure 7. LM97593 DVGA Interface Timing

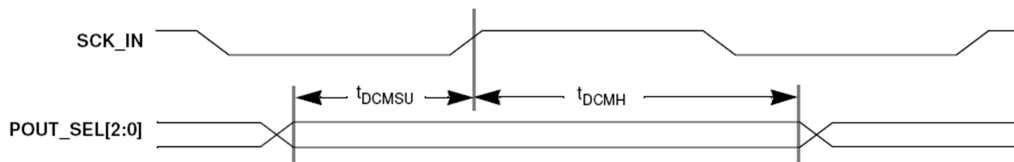

Figure 8. LM97593 Dual Chip Mode Timing

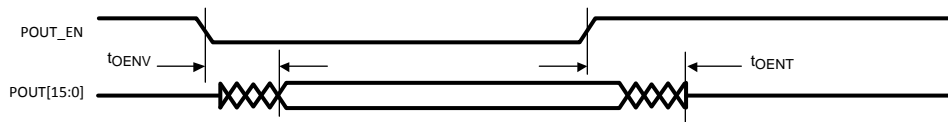

Figure 9. LM97593 Parallel Output Enable Timing

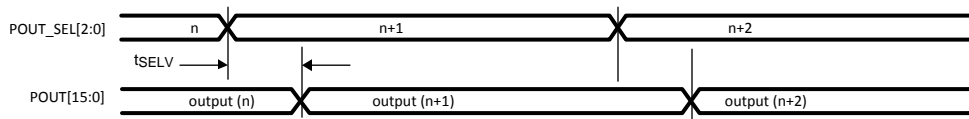

Figure 10. LM97593 Parallel Output Select Timing

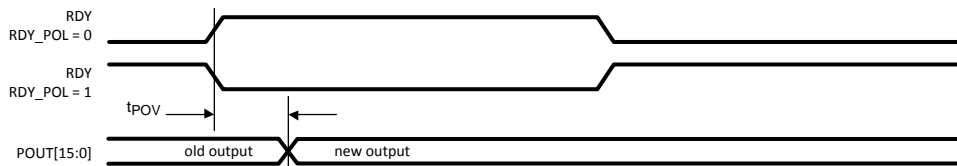

Figure 11. LM97593 Parallel Output Data Ready Timing

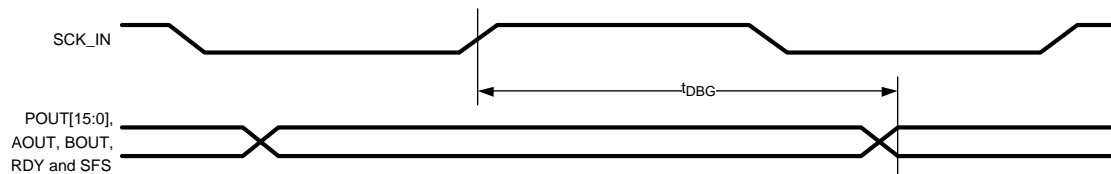

Figure 12. LM97593 Debug Mode Timing

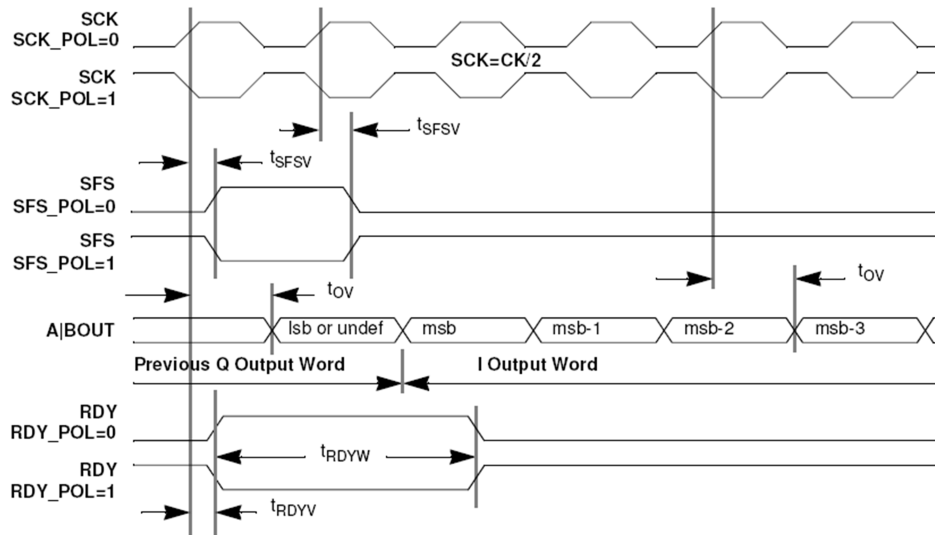

Figure 13. LM97593 Serial Port Timing

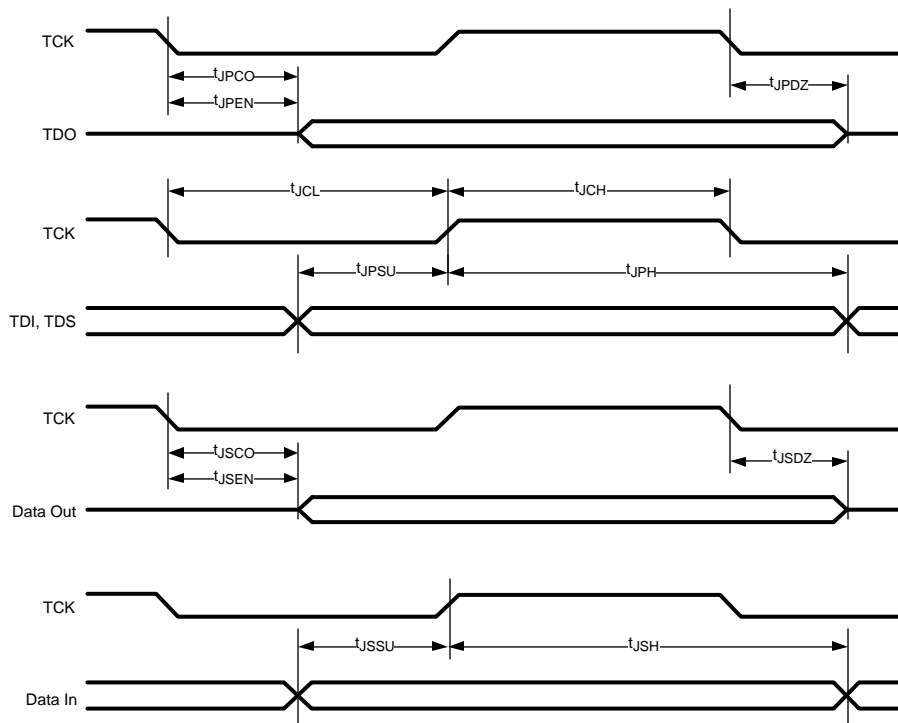

Figure 14. LM97593 JTAG Port Timing

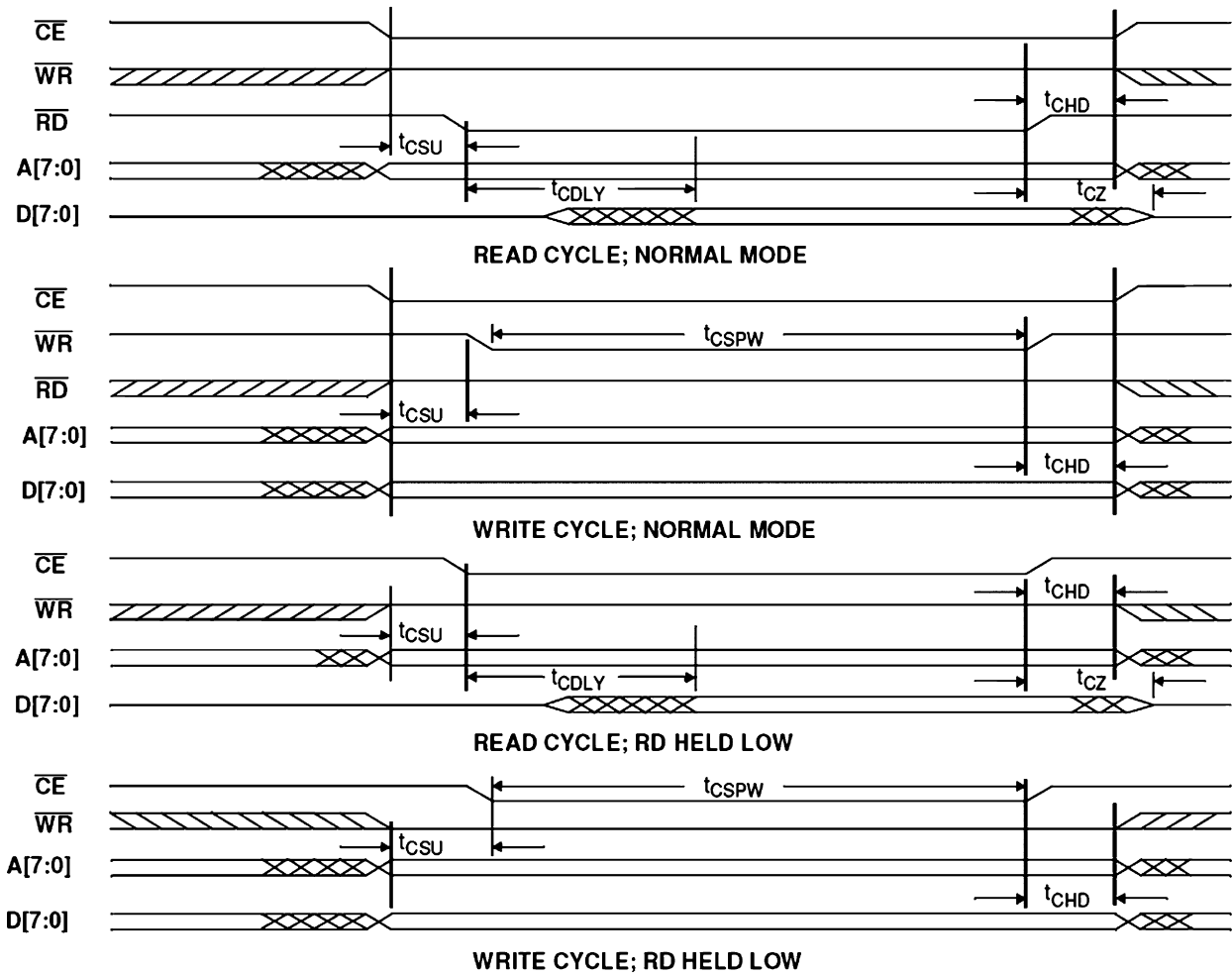

Figure 15. LM97593 Control I/O Timing

ADC Typical Performance Characteristics DNL, INL

Unless otherwise specified, the following specifications apply for AGND = DGND = D18GND = DRGND = 0V, $V_A = V_D = V_{DR} = +3.3V$, $V_{D18} = +1.8V$, PD = 0V, Internal $V_{REF} = +1.0V$, $f_{CLK} = 65\text{ MHz}$, $f_{IN} = 12\text{ MHz}$, $A_{IN} = 0\text{dBFS}$, $C_L = 10\text{ pF/pin}$, Duty Cycle Stabilizer On. **Boldface limits apply for $T_J = T_{MIN}$ to T_{MAX}** ; all other limits $T_J = 25^\circ\text{C}$

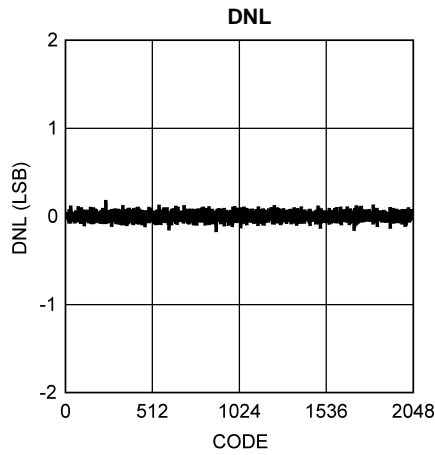

Figure 16.

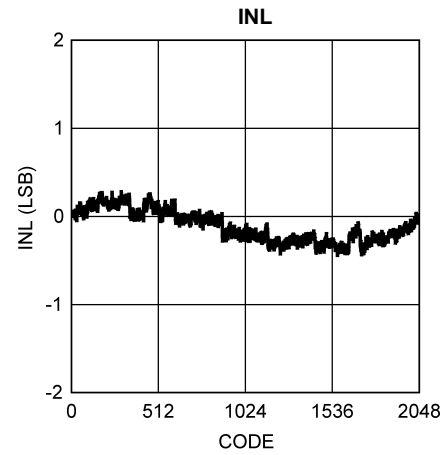

Figure 17.

ADC Typical Performance Characteristics

Unless otherwise specified, the following specifications apply for AGND = DGND = D18GND = DRGND = 0V, $V_A = V_D = V_{DR} = +3.3V$, $V_{D18} = +1.8V$, PD = 0V, Internal $V_{REF} = +1.0V$, $f_{CLK} = 65\text{ MHz}$, $f_{IN} = 249\text{ MHz}$, $A_{IN} = -9\text{ dBFS}$, $C_L = 10\text{ pF/pin}$, Duty Cycle Stabilizer On. **Boldface limits apply for $T_J = T_{MIN}$ to T_{MAX}** ; all other limits $T_J = 25^\circ\text{C}$

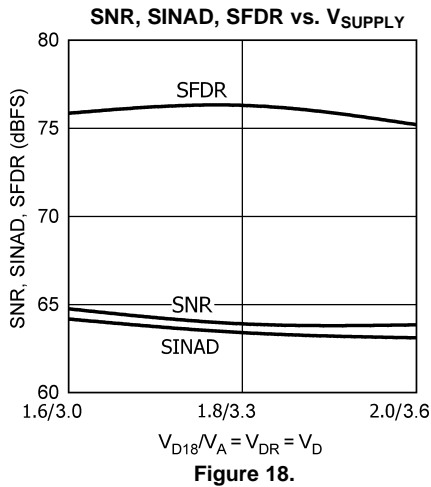

Figure 18.

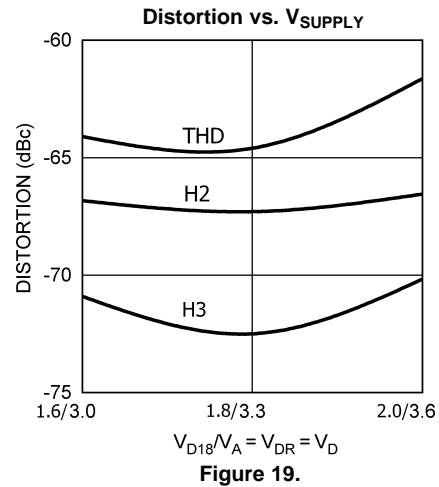

Figure 19.

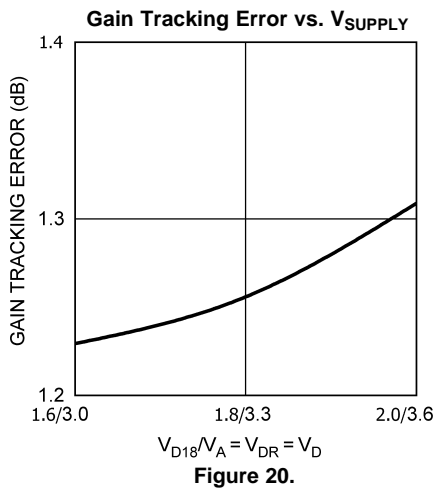

Figure 20.

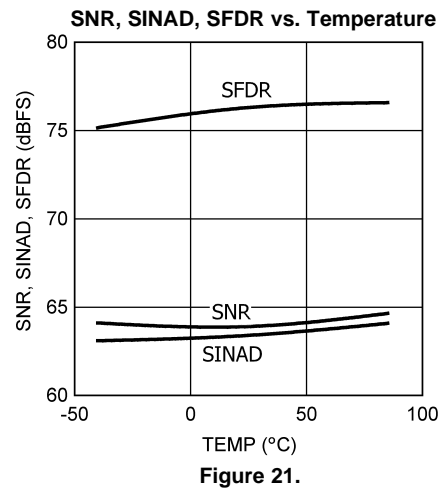

Figure 21.

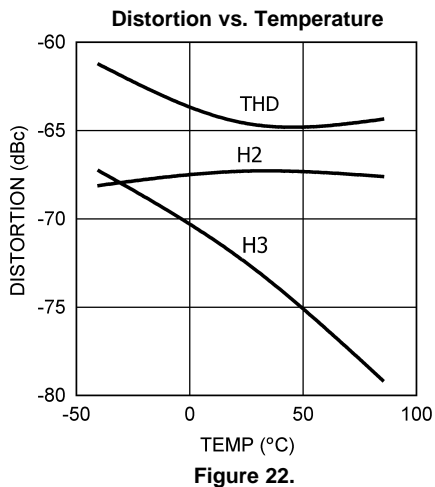

Figure 22.

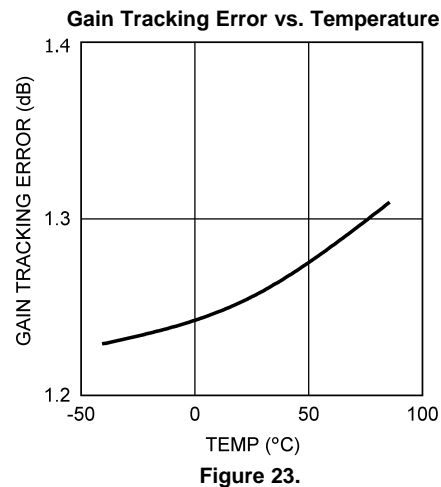

Figure 23.

ADC Typical Performance Characteristics (continued)

Unless otherwise specified, the following specifications apply for AGND = DGND = D18GND = DRGND = 0V, $V_A = V_D = V_{DR} = +3.3V$, $V_{D18} = +1.8V$, PD = 0V, Internal $V_{REF} = +1.0V$, $f_{CLK} = 65\text{ MHz}$, $f_{IN} = 249\text{ MHz}$, $A_{IN} = -9\text{dBFS}$, $C_L = 10\text{ pF/pin}$, Duty Cycle Stabilizer On. **Boldface limits apply for $T_J = T_{MIN}$ to T_{MAX}** : all other limits $T_J = 25^\circ\text{C}$

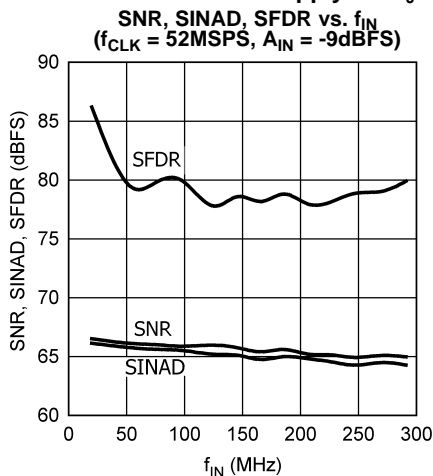

Figure 24.

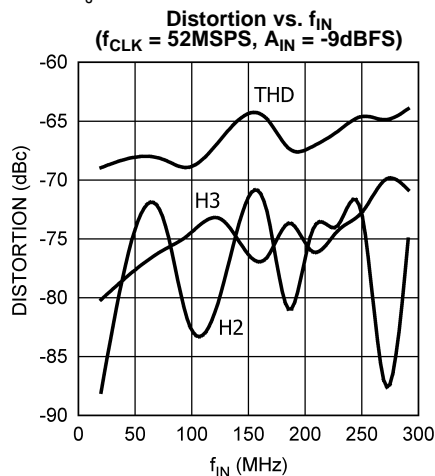

Figure 25.

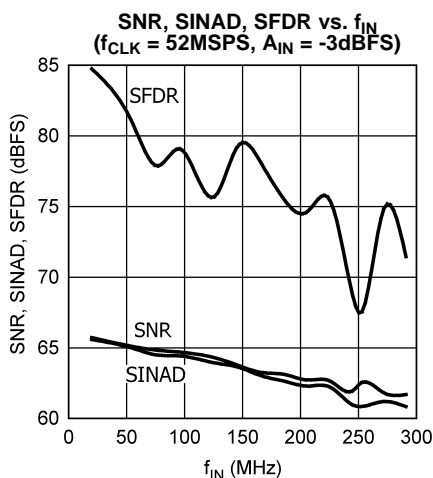

Figure 26.

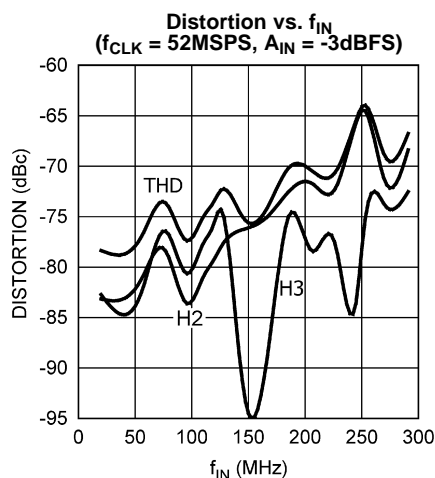

Figure 27.

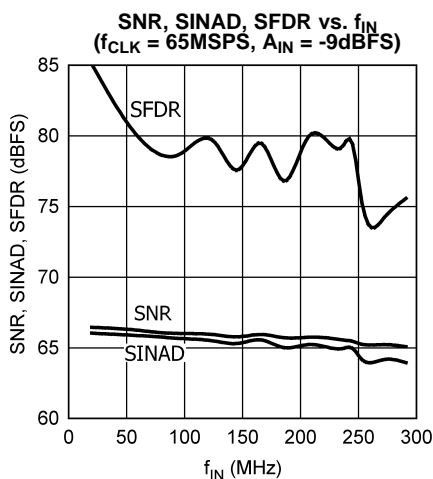

Figure 28.

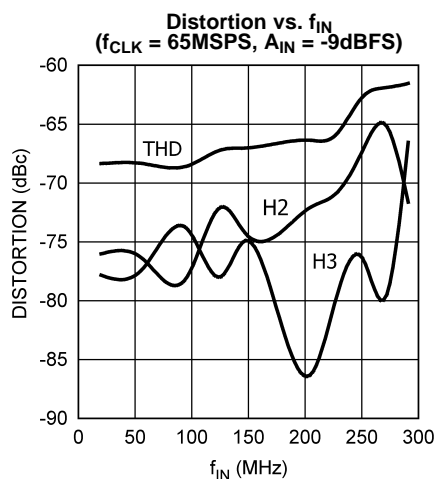

Figure 29.

ADC Typical Performance Characteristics (continued)

Unless otherwise specified, the following specifications apply for AGND = DGND = D18GND = DRGND = 0V, $V_A = V_D = V_{DR} = +3.3V$, $V_{D18} = +1.8V$, PD = 0V, Internal $V_{REF} = +1.0V$, $f_{CLK} = 65\text{ MHz}$, $f_{IN} = 249\text{ MHz}$, $A_{IN} = -9\text{dBFS}$, $C_L = 10\text{ pF/pin}$, Duty Cycle Stabilizer On. **Boldface limits apply for $T_J = T_{MIN}$ to T_{MAX}** : all other limits $T_J = 25^\circ\text{C}$

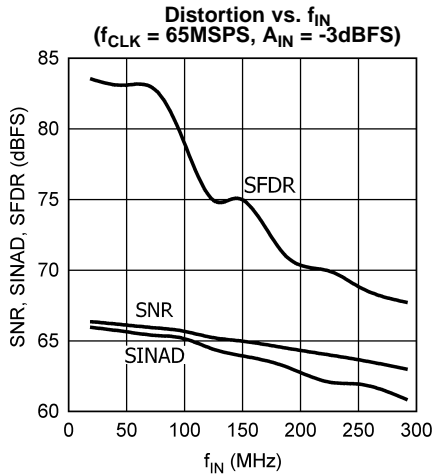

Figure 30.

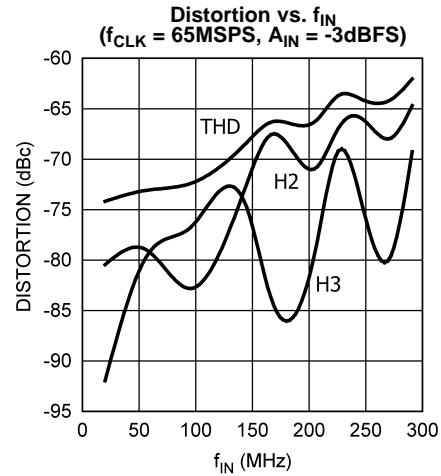

Figure 31.

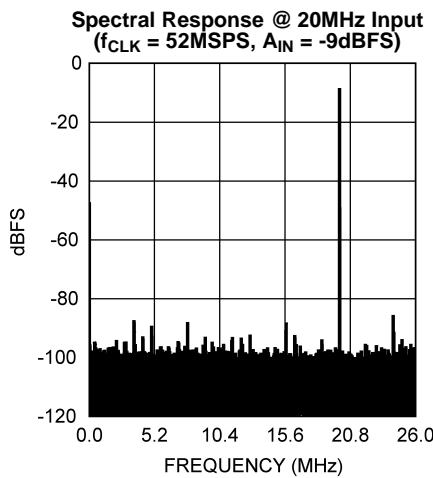

Figure 32.

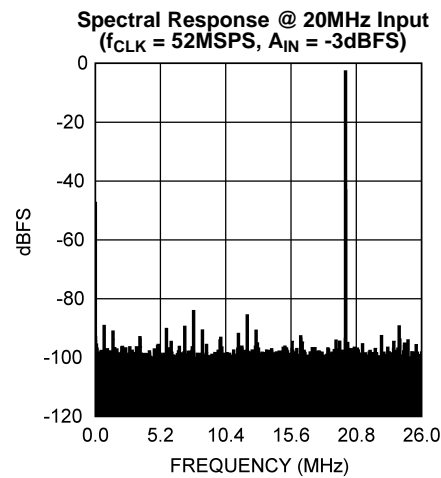

Figure 33.

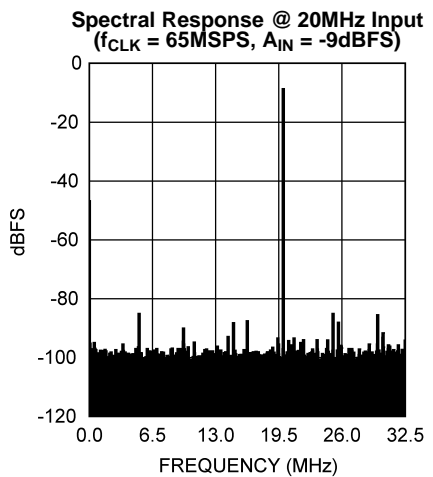

Figure 34.

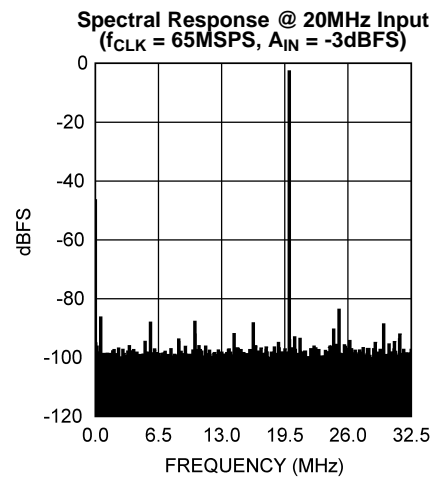

Figure 35.

ADC Typical Performance Characteristics (continued)

Unless otherwise specified, the following specifications apply for AGND = DGND = D18GND = DRGND = 0V, $V_A = V_D = V_{DR} = +3.3V$, $V_{D18} = +1.8V$, PD = 0V, Internal $V_{REF} = +1.0V$, $f_{CLK} = 65\text{ MHz}$, $f_{IN} = 249\text{ MHz}$, $A_{IN} = -9\text{dBFS}$, $C_L = 10\text{ pF/pin}$, Duty Cycle Stabilizer On. **Boldface limits apply for $T_J = T_{MIN}$ to T_{MAX}** ; all other limits $T_J = 25^\circ\text{C}$

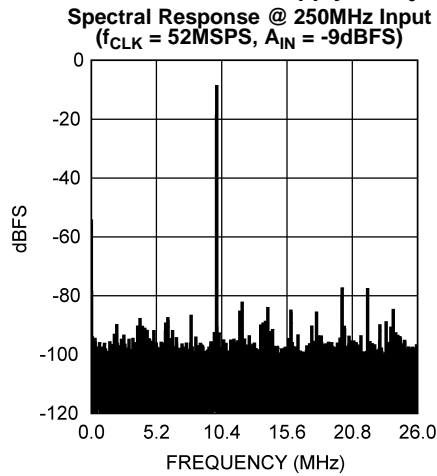

Figure 36.

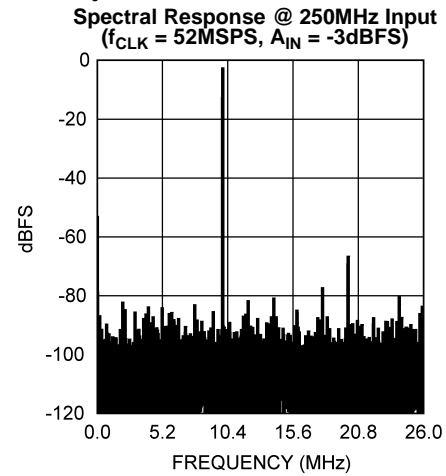

Figure 37.

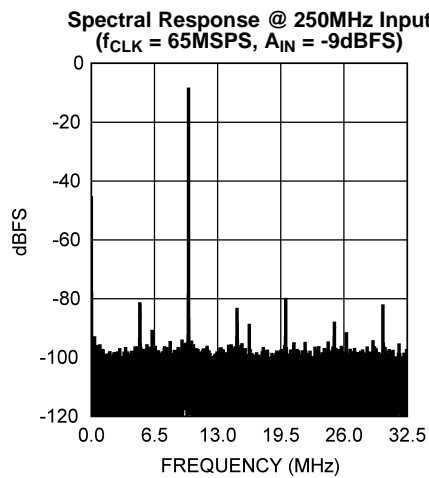

Figure 38.

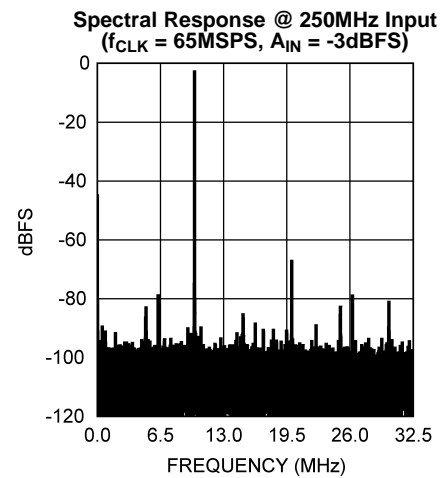

Figure 39.

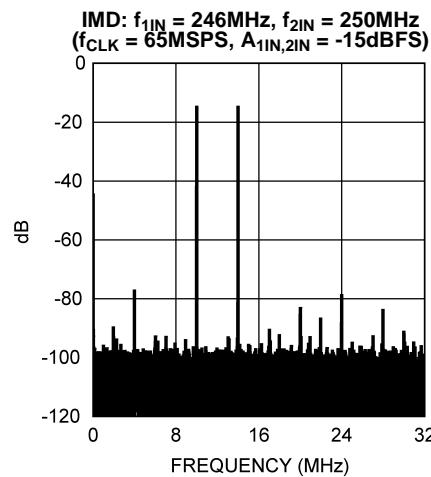

Figure 40.

CIC Output Typical Performance Characteristics

Unless otherwise specified, the following specifications apply for AGND = DGND = D18GND = DRGND = 0V, $V_A = V_D = V_{DR} = +3.3V$, $V_{D18} = +1.8V$, PD = 0V, Internal $V_{REF} = +1.0V$, $f_{CLK} = 65\text{ MHz}$, $f_{IN} = 249\text{ MHz}$, $A_{IN} = -9\text{dBFS}$, $C_L = 10\text{ pF/pin}$, Duty Cycle Stabilizer On. **Boldface limits apply for $T_J = T_{MIN}$ to T_{MAX}** ; all other limits $T_J = 25^\circ\text{C}$

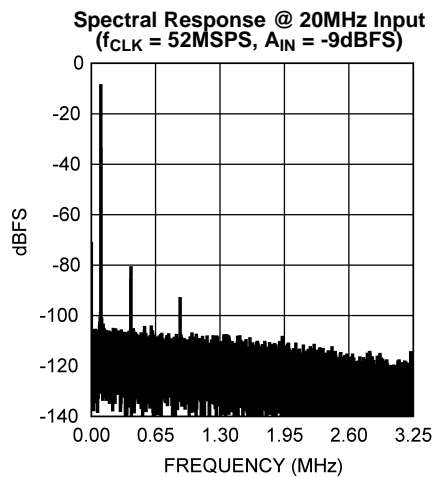

Figure 41.

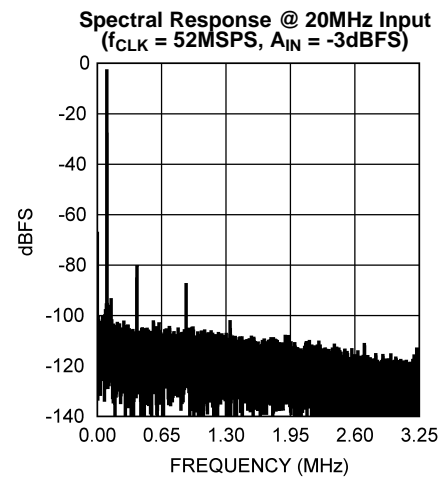

Figure 42.

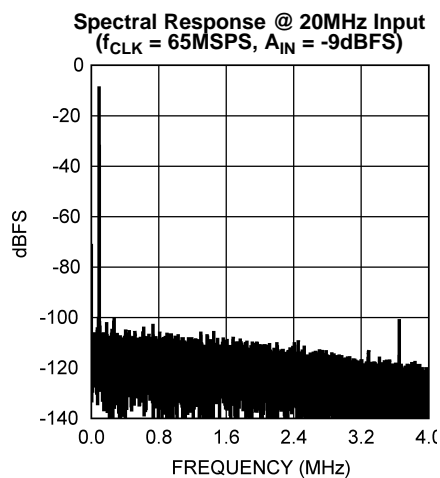

Figure 43.

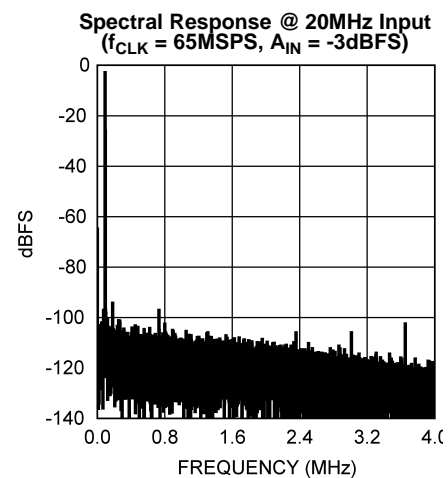

Figure 44.

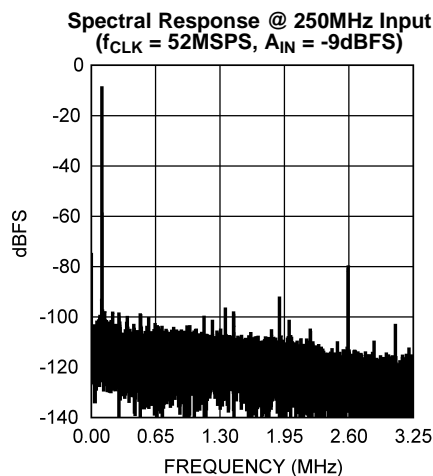

Figure 45.

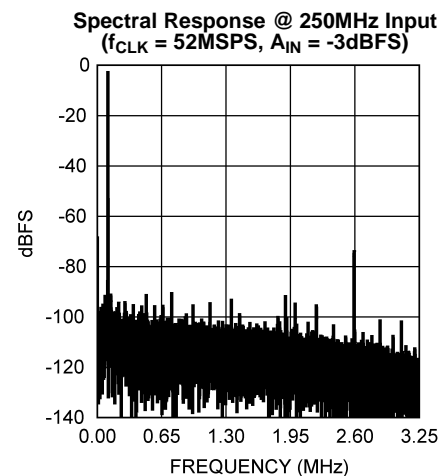

Figure 46.

CIC Output Typical Performance Characteristics (continued)

Unless otherwise specified, the following specifications apply for AGND = DGND = D18GND = DRGND = 0V, $V_A = V_D = V_{DR} = +3.3V$, $V_{D18} = +1.8V$, PD = 0V, Internal $V_{REF} = +1.0V$, $f_{CLK} = 65\text{ MHz}$, $f_{IN} = 249\text{ MHz}$, $A_{IN} = -9\text{dBFS}$, $C_L = 10\text{ pF/pin}$, Duty Cycle Stabilizer On. **Boldface limits apply for $T_J = T_{MIN}$ to T_{MAX}** ; all other limits $T_J = 25^\circ\text{C}$

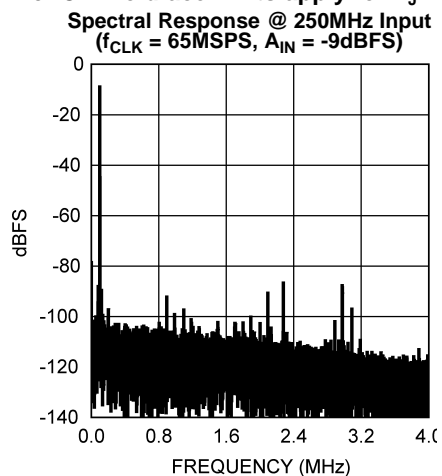

Figure 47.

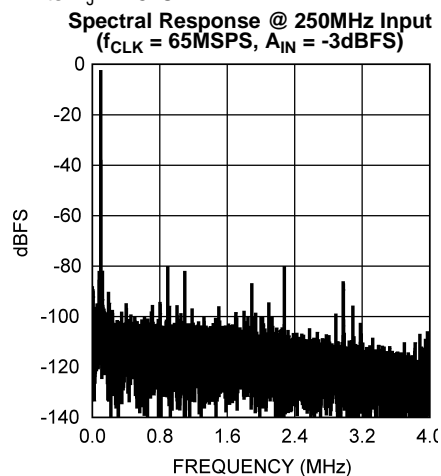

Figure 48.

DDC Output Typical Performance Characteristics

Unless otherwise specified, the following specifications apply for AGND = DGND = D18GND = DRGND = 0V, $V_A = V_D = V_{DR} = +3.3V$, $V_{D18} = +1.8V$, PD = 0V, CIC decimation = 8, Internal $V_{REF} = +1.0V$, $f_{CLK} = 65\text{ MHz}$, $f_{IN} = 249\text{ MHz}$, $A_{IN} = -9\text{dBFS}$, $C_L = 10\text{ pF/pin}$, Duty Cycle Stabilizer On. **Boldface limits apply for $T_J = T_{MIN}$ to T_{MAX}** ; all other limits $T_J = 25^\circ\text{C}$

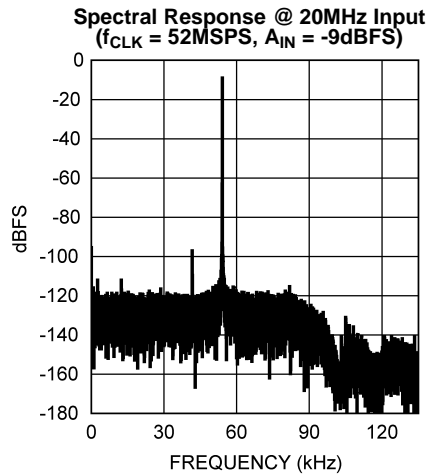

Figure 49.

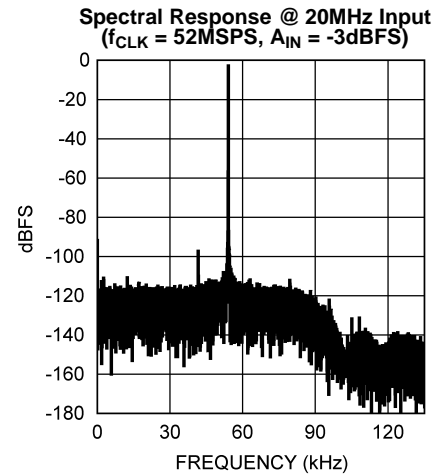

Figure 50.

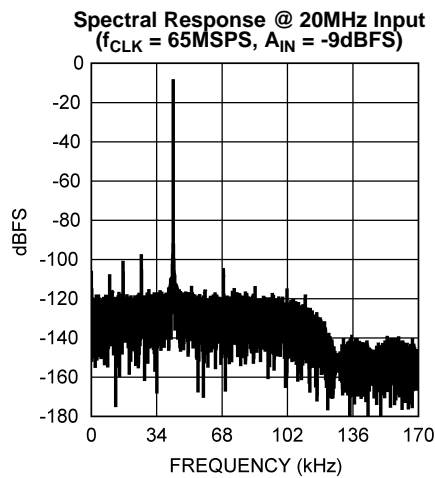

Figure 51.

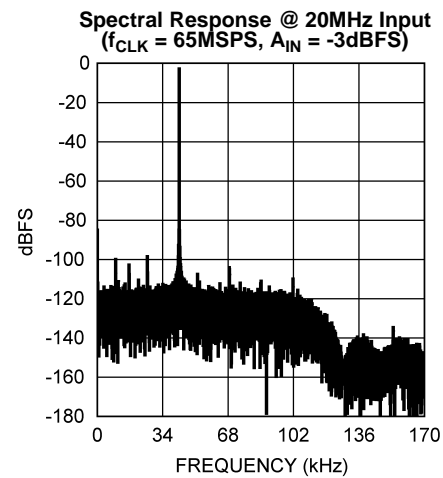

Figure 52.

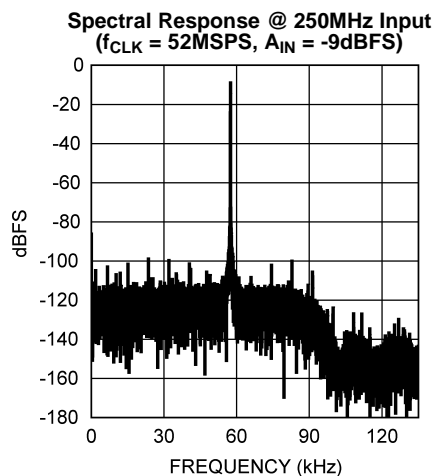

Figure 53.

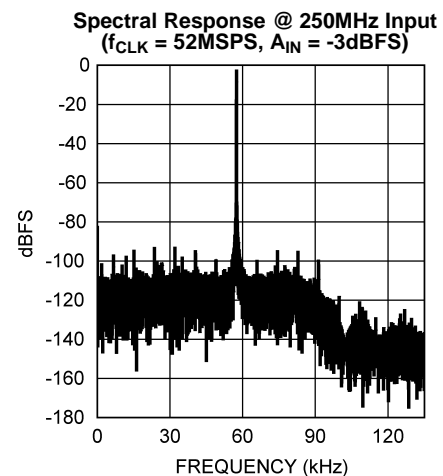

Figure 54.

DDC Output Typical Performance Characteristics (continued)

Unless otherwise specified, the following specifications apply for AGND = DGND = D18GND = DRGND = 0V, $V_A = V_D = V_{DR} = +3.3V$, $V_{D18} = +1.8V$, PD = 0V, CIC decimation = 8, Internal $V_{REF} = +1.0V$, $f_{CLK} = 65\text{ MHz}$, $f_{IN} = 249\text{ MHz}$, $A_{IN} = -9\text{ dBFS}$, $C_L = 10\text{ pF/pin}$, Duty Cycle Stabilizer On. **Boldface limits apply for $T_J = T_{MIN}$ to T_{MAX}** ; all other limits $T_J = 25^\circ\text{C}$

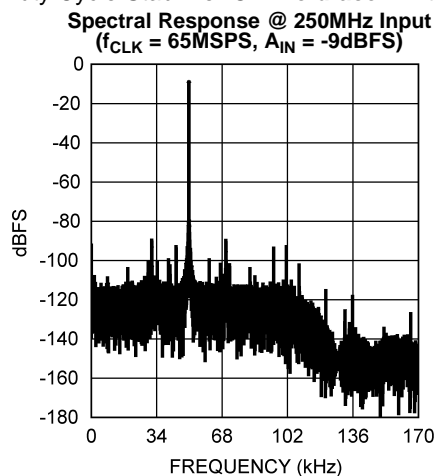

Figure 55.

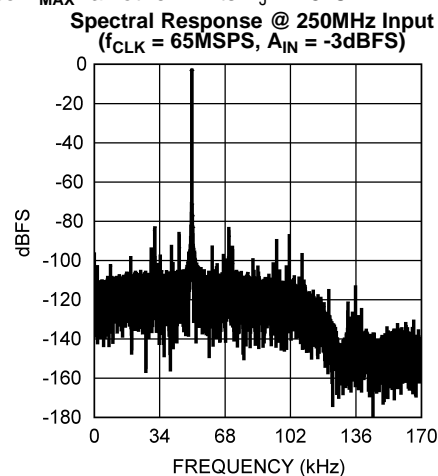

Figure 56.

FUNCTIONAL DESCRIPTION

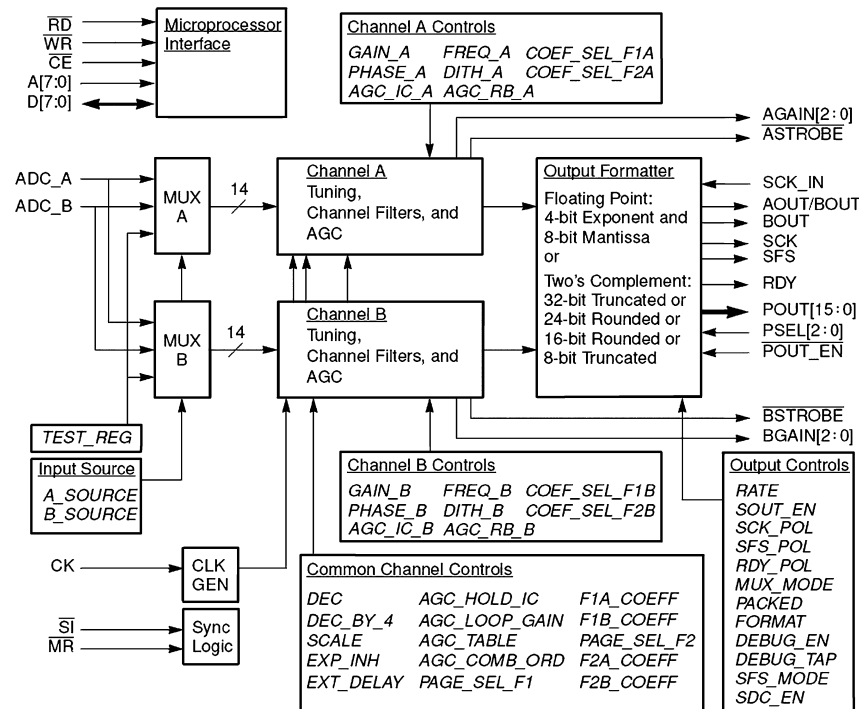

Figure 57. LM97593 Dual ADC / Digital Tuner / AGC Block Diagram with Control Register Associations

The LM97593 contains two identical 12-bit ADCs driving the digital down-conversion (DDC) circuitry shown in the block diagram in [Figure 57](#).

ADC

The ADCs operate off of a +3.3V supply and use a pipeline architecture with error correction circuitry to help ensure maximum performance. The differential analog input signal is digitized to 12 bits. The user has the choice of using an internal 1.0 Volt or an external reference. Any external reference is buffered on-chip to ease the task of driving that pin.

The clock frequency is rated up to 65 MHz. The analog input for both channels is acquired at the rising edge of the clock. The digital data for a given sample is delayed by the pipeline for 7 clock cycles before it reaches the input to the DDC circuit. A logic high on the power down (PD) pin reduces the converter power consumption to 50 mW. The DDC power can be further reduced by gating off the clock as described in section [POWER MANAGEMENT](#).

DDC

Each independent DDC channel down converts the sub-sampled IF to baseband, decimates the signal rate by a programmable factor ranging from 32 to 16384, provides channel filtering, and outputs quadrature symbols.

A crossbar switch enables either of the two inputs or a test register to be routed to either DDC channel. Flexible channel filtering is provided by the two programmable decimating FIR filters. The final filter outputs can be converted to a 12-bit floating point format or standard two's complement format. The output data is available at both serial and parallel ports.

The LM97593's DDC maintains over 100 dB of spurious free dynamic range and over 100 dB of out-of-band rejection. This allows considerable latitude in channel filter partitioning between the analog and digital domains.

The frequencies, phase offsets, and phase dither of the two sine/cosine numerically controlled oscillators (NCOs) can be independently specified. Two sets of coefficient memories and a crossbar switch allow shared or independent filter coefficients and bandwidth for each channel. Both channels share the same decimation ratio and input/output formats.

Each channel has its own AGC circuit for use with narrowband radio channels where most of the channel filtering precedes the ADC. The AGC closes the loop around the DVGA, compressing the dynamic range of the signal into the ADC. AGC gain compensation in the LM97593 removes the DVGA gain steps at the output. The time alignment of this gain compensation circuit can be adjusted. The AGC can be configured to operate continuously or set to a fixed gain. The two AGC circuits operate independently but share the same programmed parameters and control signals.

The chip receives configuration and control information over a microprocessor-compatible bus consisting of an 8-bit data I/O port, an 8-bit address port, a chip enable strobe, a read strobe, and a write strobe. The chip's control registers (8 bits each) are memory mapped into the 8-bit address space of the control port. Page select bits allow access to the overlaid A and B set of FIR coefficients.

JTAG boundary scan and on-chip diagnostic circuits are provided to simplify system debug and test.

The LM97593 supports 3.3V I/O even though the core logic voltage is 1.8V. The LM97593 outputs swing to the 3.3V rail so they can be directly connected to 5V TTL inputs if desired.

ADC Application Information

ADC OPERATING CONDITIONS

We recommend that the following conditions be observed for operation:

$$3.0V \leq V_A \leq 3.6V$$

$$V_D = V_A = V_{DR}$$

$$V_{D18} = 1.8V$$

$$10 \text{ MHz} \leq f_{CLK} \leq 65 \text{ MHz}$$

1.0 V internal reference

$$V_{CM} = 1.5V \text{ (from } V_{COMA} \text{ and } V_{COMB})$$

Analog Inputs

There is one reference input pin, V_{REF} , which is used to select an internal reference, or to supply an external reference. The ADC has two analog signal input pairs, $V_{IN} A+$ and $V_{IN} A-$ for one converter and $V_{IN} B+$ and $V_{IN} B-$ for the other converter. Each pair of pins forms a differential input pair.

Reference Pins

The ADC is designed to operate with an internal 1.0V reference or an external 1.0V reference, but performs well with external reference voltages in the range of 0.8V to 1.2V. Lower reference voltages will decrease the signal-to-noise ratio (SNR) of the ADC. Increasing the reference voltage (and the input signal swing) beyond 1.2V may degrade THD for a full-scale input, especially at higher input frequencies.

It is important that all grounds associated with the reference voltage and the analog input signal make connection to the ground plane at a single, quiet point to minimize the effects of noise currents in the ground path.

The six Reference Bypass Pins ($V_{RP}A$, $V_{COM}A$, $V_{RN}A$, $V_{RP}B$, $V_{COM}B$ and $V_{RN}B$) are made available for bypass purposes. All these pins should each be bypassed to ground with a 0.1 μ F capacitor. A 10 μ F capacitor should be placed between the $V_{RP}A$ and $V_{RN}A$ pins and between the $V_{RP}B$ and $V_{RN}B$ pins, as shown in [Figure 86](#). This configuration is necessary to avoid reference oscillation, which could result in reduced SFDR and/or SNR.

Smaller capacitor values than those specified will allow faster recovery from the power down mode, but may result in degraded noise performance. Loading any of these pins other than $V_{COM}A$ and $V_{COM}B$ may result in performance degradation.

The nominal voltages for the reference bypass pins are as follows:

$$V_{\text{COM}} = 1.5 \text{ V}$$

$$V_{\text{RP}} = V_{\text{COM}} + V_{\text{REF}} / 2$$

$$V_{\text{RN}} = V_{\text{COM}} - V_{\text{REF}} / 2$$

User choice of an on-chip or external reference voltage is provided. The internal 1.0 Volt reference is in use when the the V_{REF} pin is connected to V_{A} . If a voltage in the range of 0.8V to 1.2V is applied to the V_{REF} pin, that is used for the voltage reference. When an external reference is used, the V_{REF} pin should be bypassed to ground with a 0.1 μF capacitor close to the reference input pin. There is no need to bypass the V_{REF} pin when the internal reference is used.

Signal Inputs

The signal inputs are $V_{\text{IN A+}}$ and $V_{\text{IN A-}}$ for one ADC and $V_{\text{IN B+}}$ and $V_{\text{IN B-}}$ for the other ADC . The input signal, V_{IN} , is defined as

$$V_{\text{IN A}} = (V_{\text{IN A+}}) - (V_{\text{IN A-}}) \quad (1)$$

for the "A" converter and

$$V_{\text{IN B}} = (V_{\text{IN B+}}) - (V_{\text{IN B-}}) \quad (2)$$

for the "B" converter.

Figure 58 shows the expected input signal range. Note that the common mode input voltage, V_{CM} , should be in the range of 1.0V to 2.0V.

The peaks of the individual input signals should never exceed 2.6V.

The ADC performs best with a differential input signal with each input centered around a common mode voltage, V_{CM} . The peak-to-peak voltage swing at each analog input pin should not exceed the value of the reference voltage or the output data will be clipped.

The two input signals should be exactly 180° out of phase from each other and of the same amplitude. For single frequency inputs, angular errors result in a reduction of the effective full scale input. For complex waveforms, however, angular errors will result in distortion.

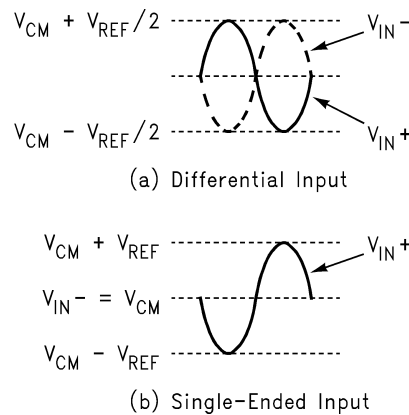

Figure 58. Expected Input Signal Range

For single frequency sine waves the full scale error in LSBs can be described as approximately

$$E_{\text{FS}} = 4096 (1 - \sin(90^\circ + \text{dev}))$$

where

- dev is the angular difference in degrees between the two signals having a 180° relative phase relationship to each other (see Figure 59) (3)

Drive the analog inputs with a source impedance less than 100 Ω .

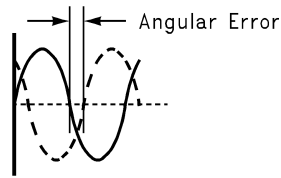

Figure 59. Angular Errors Between the Two Input Signals Will Reduce the Output Level or Cause Distortion

For differential operation, each analog input pin of the differential pair should have a peak-to-peak voltage equal to the reference voltage, V_{REF} , be 180 degrees out of phase with each other and be centered around V_{CM} .

Single-Ended Operation

Performance with differential input signals is better than with single-ended signals. For this reason, single-ended operation is not recommended. However, if single ended-operation is required and the resulting performance degradation is acceptable, one of the analog inputs should be connected to the d.c. mid point voltage of the driven input. The peak-to-peak input signal at the driven input pin should be twice the reference voltage to maximize SNR and SINAD performance (Figure 58b). For example, set V_{REF} to 1.0V, bias V_{IN-} to 1.5V and drive V_{IN+} with a signal range of 0.5V to 2.5V.

Because very large input signal swings can degrade distortion performance, better performance with a single-ended input can be obtained by reducing the reference voltage when maintaining a full-range output.

Driving the Analog Inputs

The V_{IN+} and the V_{IN-} inputs of the ADC consist of an analog switch followed by a switched-capacitor amplifier. As the internal sampling switch opens and closes, current pulses occur at the analog input pins, resulting in voltage spikes at the signal input pins. As the driving source attempts to counteract these voltage spikes, it may add noise to the signal at the ADC analog input. C1, C2, and C3 as shown in Figure 86 improve the ADC performance by filtering these voltage spikes. These components should be placed close to the ADC inputs because the input pins of the ADC are the most sensitive part of the system and this is the last opportunity to filter that input.

For Nyquist applications the RC pole should be at the ADC sample rate. The ADC input capacitance in the sample mode should be considered when setting the RC pole. For wideband undersampling applications, the RC pole should be set at about 1.5 to 2 times the maximum input frequency to maintain a linear delay response. The values of the RC shown in Figure 86 are suitable for applications with input frequencies up to approximately 70MHz.

Input Common Mode Voltage

The input common mode voltage, V_{CM} , should be in the range of 1.0V to 2.0V and be a value such that the peak excursions of the analog signal do not go more negative than ground or more positive than 2.6V. See Reference Pins.

DIGITAL INPUTS

Digital TTL/CMOS compatible inputs consist of CK, REFSEL/DCS.

CLK

The **CLK** signal controls the timing of the sampling process. Drive the clock input with a stable, low jitter clock signal in the range of 10 MHz to 65 MHz. The higher the input frequency, the more critical it is to have a low jitter clock. The trace carrying the clock signal should be as short as possible and should not cross any other signal line, analog or digital, not even at 90°.

The **CLK** signal also drives an internal state machine. If the **CLK** is interrupted, or its frequency too low, the charge on internal capacitors can dissipate to the point where the accuracy of the output data will degrade. This is what limits the lowest sample rate.

The clock line should be terminated at its source in the characteristic impedance of that line. Take care to maintain a constant clock line impedance throughout the length of the line. Refer to Application Note AN-905 (literature number [SNLA035](#)) for information on setting characteristic impedance.

It is highly desirable that the the source driving the ADC **CLK** pin only drive that pin. However, if that source is used to drive other things, each driven pin should be a.c. terminated with a series RC to ground such that the resistor value is equal to the characteristic impedance of the clock line and the capacitor value is

$$C \geq \frac{4 \times t_{PD} \times L}{Z_0}$$

where

- t_{PD} is the signal propagation time down the clock line
 - "L" is the line length
 - Z_0 is the characteristic impedance of the clock line
- (4)

This termination should be as close as possible to the ADC clock pin but beyond it as seen from the clock source. Typical t_{PD} is about 150 ps/inch (60 ps/cm) on FR-4 board material. The units of "L" and t_{PD} should be the same (inches or centimeters).

The duty cycle of the clock signal can affect the performance of the A/D Converter. Because achieving a precise duty cycle is difficult, the LM97593 has a Duty Cycle Stabilizer which can be enabled using the REFSEL/DCS pin. It is designed to maintain performance over a clock duty cycle range of 30% to 70% at 65 MSPS.

REFSEL/DCS

This pin is used in conjunction with V_{REF} (pin 21) to select the reference source and turn the Duty Cycle Stabilizer (DCS) on or off.

When REFSEL/DCS is LOW and V_{REF} is HIGH, the internal 1.0V reference is selected and DCS is On.

When REFSEL/DCS is HIGH, an external reference voltage in the range of 0.8V to 1.2V should be applied to the VREF input. DCS is On.

With REFSEL/DCS pin connected to V_{COMA} or V_{COMB} , the internal 1.0V reference is selected and DCS is Off.

When enabled, duty cycle stabilization can compensate for clock inputs with duty cycles ranging from 30% to 70% and generate a stable internal clock, improving the performance of the part.

Table 1. V_{REF} , REFSEL/DCS Pin Functions

REFSEL/DCS (pin 8)	V_{REF} (pin 21)	Reference	DCS
Logic Low	Logic High	Internal 1.0 V	ON
Logic High	0.8 to 1.2V	External	ON
V_{COMA} or V_{COMB}	Logic High	Internal 1.0V	OFF
V_{COMA} or V_{COMB}	0.8 to 1.2V	External	OFF

PD

The PD pin, when high, holds the ADC in a power-down mode to conserve power when the converter is not being used. The output data pins are undefined and the data in the pipeline is corrupted while in the power down mode.

The Power Down Mode Exit Cycle time is determined by the value of the components on pins 15, 16, 17, 22, 23 and 24. These capacitors lose their charge in the Power Down mode and must be recharged by on-chip circuitry before conversions can be accurate. Smaller capacitor values allow slightly faster recovery from the power down mode, but can result in a reduction in SNR, SINAD and ENOB performance.

DDC Application Information

CONTROL INTERFACE

The LM97593 is configured by writing control information into 237 control registers within the chip. The contents of these control registers and how to use them are described in [Control Register Addresses and Defaults](#). The registers are written to or read from using the **D[7:0]**, **A[7:0]**, **CE**, **RD** and **WR** pins. This interface is designed to allow the LM97593 to appear to an external processor as a memory mapped peripheral. See [Figure 15](#) for details.

The control interface is asynchronous with respect to the system clock, **CK**. This allows the registers to be written or read at any time. In some cases this might cause an invalid operation since the interface is not internally synchronized. In order to assure correct operation, **SI** must be asserted after the control registers are written.

The **D[7:0]**, **A[7:0]**, **WR**, **RD** and **CE** pins should not be driven above the positive supply voltage.

Master Reset

A master reset pin, **MR**, is provided to initialize the LM97593 to a known condition and should be strobed after power up. This signal will clear all sample data and all user programmed data (filter coefficients and AGC settings). All outputs will be disabled (tri-stated). **ASTROBE** and **BSTROBE** will be asserted to initialize the DVGA values. [Control Register Addresses and Defaults](#) describes the control register default values.

Synchronizing Multiple LM97593 Chips

A system containing two or more LM97593 chips will need to be synchronized if coherent operation is desired. To synchronize multiple LM97593 chips, connect all of the sync input pins together so they can be driven by a common sync strobe. Synchronization occurs on the first rising edge of **CK** after **SI** goes high. When **SI** is asserted all sample data is immediately cleared, the numerically controlled oscillator (NCO) phase offset is initialized, the NCO dither generators are reset, and the CIC decimation ratio is initialized. Only the configuration data loaded into the microprocessor interface remains unaffected.

SI may be held low as long as desired after a minimum of 4 **CK** periods.

Input Source

The input crossbar switch allows either **V_{IN}A**, **V_{IN}B**, or a test register to be routed to the channel A or channel B AGC/ DDC. The AGC outputs, **AGAIN** and **BGAIN**, are not switched. If **V_{IN}A** and **V_{IN}B** are exchanged the AGC loop will be open and the AGC will not function properly.

Selecting the test register as the input source allows the AGC or DDC operation to be verified with a known input. See [Test Register](#) for further discussion.

DOWN CONVERTERS

A detailed block diagram of each DDC channel is shown in [Figure 60](#). Each down converter uses a complex NCO and mixer to quadrature downconvert a signal to baseband. The “FLOAT TO FIXED CONVERTER” treats the 15-bit mixer output as a mantissa and the AGC output, **EXP**, as a 3-bit exponent. It performs a bit shift on the data based on the value of **EXP**. This bit shifting is used to expand the compressed dynamic range resulting from the DVGA operation. The DVGA gain is adjusted in 6dB steps which are equivalent to each digital bit shift.

Digitally compensating for the DVGA gain steps in the LM97593 causes the DDC output to be linear with respect to the DVGA input. The AGC operation will be completely transparent at the LM97593 output.

The exponent (**EXP**) can be forced to its maximum value by setting the EXP_INH bit. If $x_{in}(n)$ is the DDC input, the signal after the “FLOAT TO FIXED CONVERTER” is

$$x_3(n) = x_{in}(n) * \cos(\omega n) * 2^{EXP} \quad (5)$$

for the I component. Changing the ‘cos’ to ‘sin’ in this equation will provide the Q component.

The “FLOAT TO FIXED CONVERTER” circuit expands the dynamic range compression performed by the DVGA. Signals from this point onward extend across the full dynamic range of the signals applied to the DVGA input. This allows the AGC to operate continuously through a burst without producing artifacts in the signal due to the settling response of the decimation filters after a 6dB DVGA gain adjustment. For example, if the DVGA input signal were to increase causing the ADC output level to cross the AGC threshold level, the gain of the DVGA would change by -6dB. The 6dB step is allowed to propagate through the ADC and mixers and is compensated out just before the filtering. The accuracy of the compensation is dependent on timing and the accuracy of the DVGA gain step. The LM97593 allows the timing of the gain compensation to be adjusted in the EXT_DELAY register; see the end of section [AGC](#) for more information. The AGC requires 21 bits (14-bit internal bus output + 7-bit shift) to represent the full linear dynamic range of the signal. The output word must be set to either 24-bit or 32-bit to take advantage of the entire dynamic range available. The LM97593 can also be configured to output a floating point format with up to 138dB of numerical resolution using only 12 output bits.

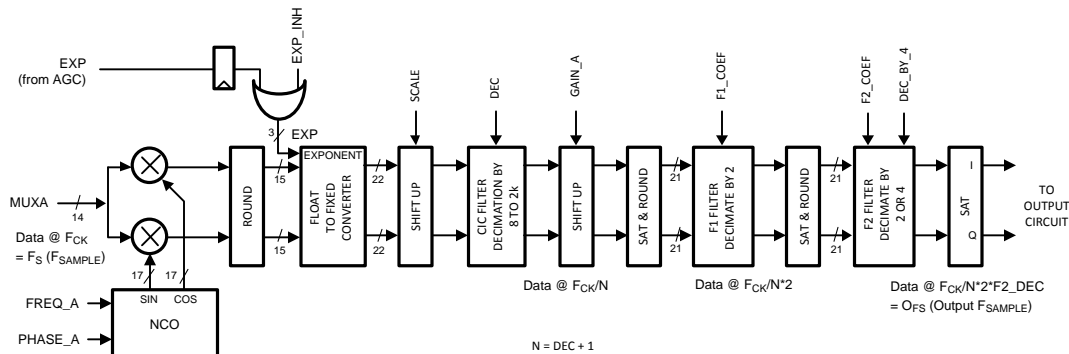

Figure 60. LM97593 Down Converter, Channel A (Channel B is identical)

The “SHIFT UP” circuit will be discussed in the section [Four Stage CIC Filter](#).

A 4-stage cascaded-integrator-comb (CIC) filter and a two-stage decimate by 4 or 8 finite impulse response (FIR) filter are used to lowpass filter and isolate the desired signal. The CIC filter reduces the sample rate by a programmable factor ranging from 8 to 2048 (decimation ratio). The CIC outputs are followed by a gain stage and then followed by a two-stage decimate by 4 or 8 filter. The gain circuit allows the user to boost the gain of weak signals by up to 42 dB in 6 dB steps. It also rounds the signal to 21 bits and saturates at plus or minus full scale.

The first stage of the two stage filter is a 21-tap, symmetric decimate by 2 FIR filter (F1) with programmable 16 bit tap weights. The coefficients of the first 11 taps are downloaded to the chip as 16 bit words. Since the filter is a symmetric configuration only the first 11 coefficients must be loaded. [First Programmable FIR Filter \(F1\)](#) provides a generic set of coefficients that compensate for the rolloff of the CIC filter and provide a passband flat to 0.01dB with 70 dB of out of band rejection. A second coefficient set is provided that has a narrower output passband and greater out-of-band rejection. The second set of coefficients is ideal for systems such as GSM where far-image rejection is more important than adjacent channel rejection.

The second stage is a 63 tap decimate by 2 or 4 programmable FIR filter (F2) also with 16 bit tap weights. Filter coefficients for a flat response from $-0.4F_S$ to $+0.4F_S$ of the output sample rate with 80dB of out of band rejection are provided in [Second Programmable FIR Filter \(F2\)](#). A second set of F2 coefficients is also provided to enhance performance for GSM systems. The user can also design and download their own final filter to customize the channel's spectral response. Typical uses of programmable filter F2 include matched (root-raised cosine) filtering, or filtering to generate oversampled outputs with greater out of band rejection. The 63 tap symmetrical filter is downloaded into the chip as 32 words, 16 bits each. Saturation to plus or minus full scale is performed at the output of F1 and F2 to clip the signal rather than allow it to roll over.

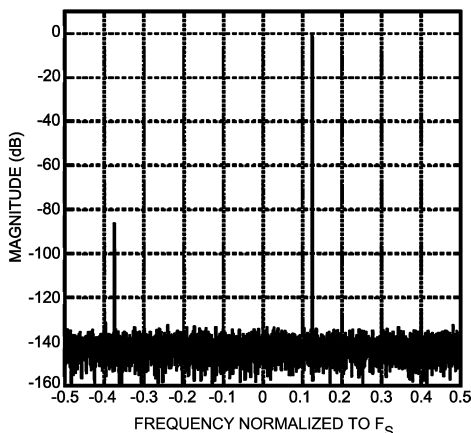

**Figure 61. Complex NCO Output Phase Dither Disabled
Example of NCO spurs due to phase truncation
(Before Phase Dithering)**

The LM97593 provides two sets of coefficient memory for both F1 and F2. These coefficient memories can be independently routed to channel A, channel B, or both channel A and B with a crossbar switch. The coefficients can be switched on the fly but some time will be required before valid output data is available.

The Numerically Controlled Oscillator

The tuning frequency of each down converter is specified as a 32 bit word (.02Hz resolution at **CK**=52MHz) and the phase offset is specified as a 16 bit word (.005°). These two parameters are applied to the Numerically Controlled Oscillator (NCO) circuit to generate sine and cosine signals used by the digital mixer. The NCOs can be synchronized with NCOs on other chips via the sync pin **SI**. This allows multiple down converter outputs to be coherently combined, each with a unique phase and amplitude.

The tuning frequency is set by loading the FREQ register according to the formula $FREQ = 2^{32}F/F_{CK}$, where F is the desired tuning frequency and F_{CK} is the chip’s clock rate. FREQ is a 2’s complement word. The range for F is from $-F_{CK}/2$ to $+F_{CK}(1-2^{-31})/2$.

If a sub-sampled signal is in an even Nyquist zone the sampling process causes the order of the I and Q components to be reversed. Should this occur simply invert the polarity of the tuning frequency F.

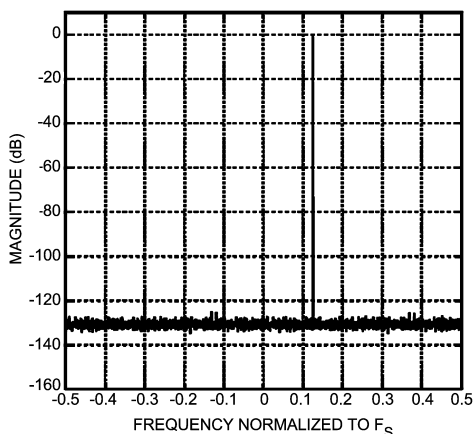

**Figure 62. Complex NCO Output Phase Dither Enabled
Example of NCO spurs due to phase truncation
(After Phase Dithering)**

The 2’s complement format represents full-scale negative as 10000000 and full-scale positive as 01111111 for an 8-bit example.

The 16 bit phase offset is set by loading the PHASE register according to the formula $PHASE = 2^{16}P/2\pi$, where P is the desired phase in radians ranging between 0 and 2π . PHASE is an unsigned 16-bit number. P ranges from 0 to $2\pi(1-2^{-16})$. Phase dithering can be enabled to reduce the spurious signals created by the NCO due to phase truncation. This truncation is unavoidable since the frequency resolution is much finer than the phase resolution. With dither enabled, spurs due to phase truncation are below -100 dBc for all frequencies and phase offsets. Each NCO has its own dither source and the initial state of one is maximally offset with respect to the other so that they are effectively uncorrelated. The phase dither sources are on by default. They are independently controlled by the DITH_A and DITH_B bits. The amplitude resolution of the ROM creates a worst-case spur amplitude of -101dBc rendering amplitude dither unnecessary.

The spectrum plots in [Figure 61](#) and [Figure 62](#) show the effectiveness of phase dither in reducing NCO spurs due to phase truncation for a worst-case example (just below $F_S/8$). With dither off, the spur is at -86.4dBFS. With dither on, the spur is below -125dBFS, disappearing into the noise floor. This spur is spread into the noise floor which results in an SNR of -83.6dBFS. The channel filter's processing gain will further improve the SNR.

[Figure 63](#) shows the spur levels as the tuning frequency is scanned over a narrow portion of the frequency range. The spurs are again a result of phase quantization but their locations move about as the frequency scan progresses. As before, the peak spur level drops when dithering is enabled. When dither is enabled and the fundamental frequency is exactly at $F_S/8$, the worst-case spur due to amplitude quantization can be observed at -101dBc in [Figure 64](#).

Four Stage CIC Filter

The mixer outputs are decimated by a factor of N in a four stage CIC filter. N is programmable to any integer between 8 and 2048. Decimation is programmed in the DEC register where $DEC = N - 1$. The programmable decimation allows the chip's usable output bandwidth to range from about $\pm 1.27\text{kHz}$ to $\pm 650\text{kHz}$ when the input data rate (which is equal to the chip's clock rate, F_{CK}) is 52 MHz. For the maximum sample rate of 65MHz, the LM97593's output bandwidth will range from about $\pm 1.58\text{kHz}$ to $\pm 812\text{kHz}$. A block diagram of the CIC filter is shown in [Figure 65](#).

The CIC filter is primarily used to decimate the high-rate incoming data while providing a rough lowpass characteristic. The lowpass filter will have a $\sin(x)/x$ response (similar to the AGC's CIC shown in [Figure 80](#)) where the first null is at F_S/N .

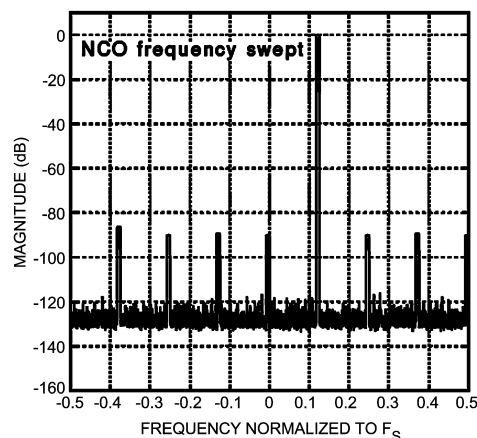

**Figure 63. Complex NCO Output Phase Dither Disabled
NCO Spurs due to Phase Quantization**

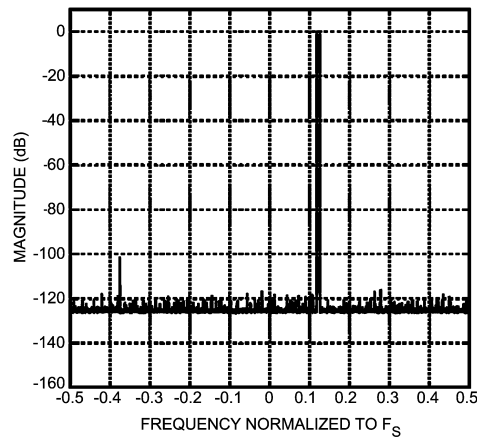

Figure 64. Complex NCO Output Phase Dither Enabled Worst Case Amplitude Spur, NCO at $F_S/8$

The CIC filter has a gain equal to N^4 (filter decimation⁴) which must be compensated for in the “SHIFT UP” circuit shown in Figure 65 as well as Figure 60. This circuit has a gain equal to $2^{(SCALE-44)}$, where SCALE ranges from 0 to 40. This circuit divides the input signal by 2^{44} providing

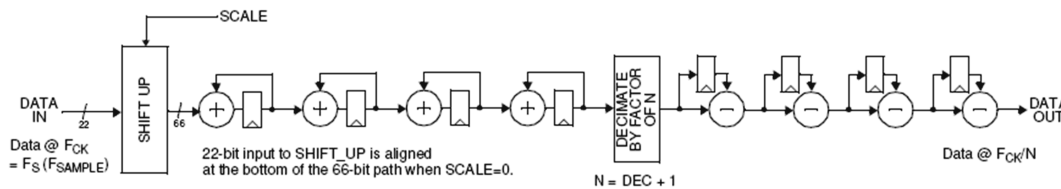

Figure 65. Four-stage decimate by N CIC filter

maximum headroom through the CIC filter. For optimal noise performance the SCALE value is set to increase this level until the CIC filter is just below the point of distortion. A value is normally calculated and loaded for SCALE such that $GAIN_{SHIFTUP} * GAIN_{CIC} \leq 1$. The actual gain of the CIC filter will only be unity for power-of-two decimation values. In other cases the gain will be somewhat less than unity.

Channel Gain

The gain of each channel can be boosted up to 42 dB by shifting the output of the CIC filter left by 0 to 7 bits prior to rounding it to 21 bits. For channel A, the gain of this stage is: $GAIN = 2^{GAIN_A}$, where GAIN_A ranges from 0 to 7. Overflow due to the GAIN circuit is saturated (clipped) at plus or minus full scale. Each channel can be given its own GAIN setting.

First Programmable FIR Filter (F1)

The CIC/GAIN outputs are followed by two stages of filtering. The first stage is a 21 tap decimate-by-2 symmetric FIR filter with programmable coefficients. Typically, this filter compensates for a slight droop induced by the CIC filter while removing undesired alias images above Nyquist. In addition, it often provides stopband assistance to F2 when deep stop bands are required. The filter coefficients are 16-bit 2's complement numbers. Unity gain will be achieved through the filter if the sum of the 21 coefficients is equal to 2^{16} . If the sum is not 2^{16} , then F1 will introduce a gain equal to (sum of coefficients)/ 2^{16} . The 21 coefficients are identified as coefficients $h_1(n)$, $n = 0, \dots, 20$ where $h_1(10)$ is the center tap. The coefficients are symmetric, so only the first 11 are loaded into the chip.

Two example sets of coefficients are provided here. The first set of coefficients, referred to as the standard set (STD), compensates for the droop of the CIC filter providing a passband which is flat (0.01 dB ripple) over 95% of the final output bandwidth with 70dB of out-of-band rejection (see Figure 66). The filter has a gain of 0.999 and is symmetric with the following 11 unique taps (1|21, 2|20, ..., 10|12, 11):

29, -85, -308, -56, 1068, 1405, -2056, -6009,
1303, 21121, 32703

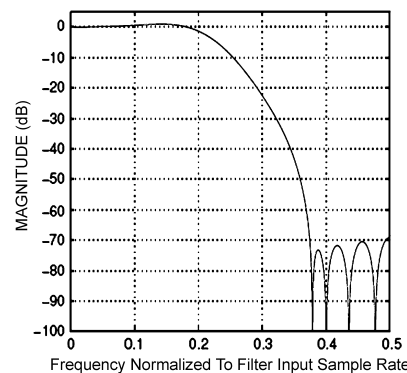

Figure 66. F1 STD frequency response

The second set of coefficients (GSM set) are intended for applications that need deeper stop bands or need oversampled outputs. These requirements are common in cellular systems where out of band rejection requirements can exceed 100dB (see Figure 67). They are useful for wideband radio architectures where the channelization is done after the ADC. These filter coefficients introduce a gain of 0.984 and are:

-49, -340, -1008, -1617, -1269, 425, 3027, 6030,
9115, 11620, 12606

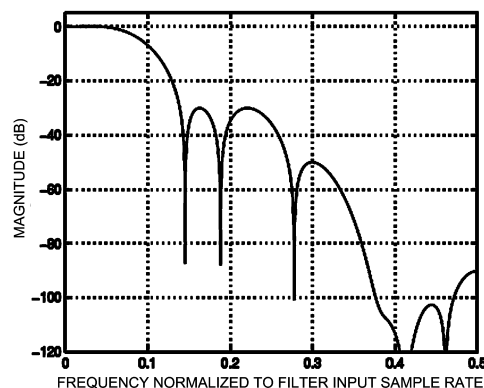

Figure 67. F1 GSM frequency response

Second Programmable FIR Filter (F2)

The second stage decimate by two or four filter also uses externally downloaded filter coefficients. F2 determines the final channel filter response. The filter coefficients are 16-bit 2's complement numbers. Unity gain will be achieved through the filter if the sum of the 63 coefficients is equal to 2^{16} . If the sum is not 2^{16} , then the F2 will introduce a gain equal to $(\text{sum of coefficients})/2^{16}$.

The 63 coefficients are identified as $h_2(n)$, $n = 0, \dots, 62$ where $h_2(31)$ is the center tap. The coefficients are symmetric, so only the first 32 are loaded into the chip. An example filter (STD F2 coefficients, see Figure 68) with 80dB out-of-band rejection, gain of 1.00, and 0.03 dB peak to peak passband ripple is created by this set of 32 unique coefficients:

-14, -20, 19, 73, 43, -70, -82, 84, 171, -49, -269,
 -34, 374, 192, -449,
 -430, 460,751, -357, -1144, 81, 1581, 443, -2026,
 -1337, 2437, 2886,
 -2770, -6127, 2987, 20544, 29647

A second set of F2 coefficients (GSM set, see Figure 69) suitable for meeting the stringent wideband GSM requirements with a gain of 0.999 are:

-536, -986, 42, 962, 869, 225, 141, 93, -280,
 -708, -774, -579, -384,
 -79, 536, 1056, 1152, 1067, 789, 32, -935, -1668,
 -2104, -2137, -1444,
 71, 2130, 4450, 6884, 9053, 10413, 10832

The filter coefficients of both filters can be used to tailor the spectral response to the user's needs. For example, the first can be loaded with the standard set to provide a flat response through to the second filter. The latter can then be programmed as a Nyquist (typically a root-raised-cosine) filter for matched filtering of digital data.

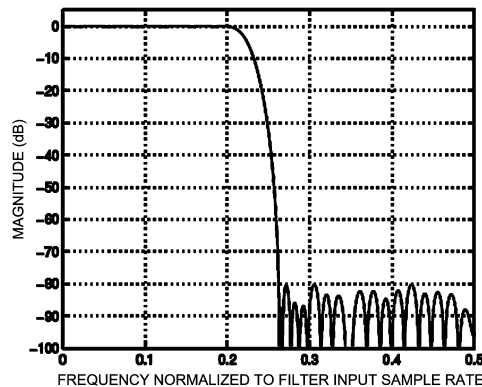

Figure 68. F2 STD frequency response

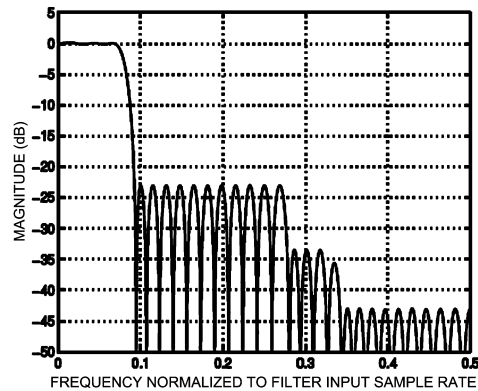

Figure 69. F2 GSM frequency response

The complete channel filter response for standard coefficients is shown in [Figure 70](#). Passband flatness is shown in [Figure 71](#). The complete filter response for GSM coefficients is shown in [Figure 72](#). GSM Passband flatness is shown in [Figure 73](#).

The mask shown in [Figure 72](#) is derived from the ETSI GSM 5.05 specifications for a normal Basestation Transceiver (BTS). For interferers, 9dB was added to the carrier to interference (C/I) ratios. For blockers, 9dB was added to the difference between the blocker level and 3dB above the reference sensitivity level.

Channel Bandwidth vs. Sample Rate

When the LM97593 is used for GSM systems, a bandwidth of about 200kHz is desired. With a sample rate of 52MHz, the total decimation of 192 provides the desired 270.833kHz output sample rate. This output sample rate in combination with the FIR filter coefficients create the desired channel bandwidth. If the sample rate is increased to 65MHz, the decimation must also be increased to 65MHz/270.833kHz or 240.

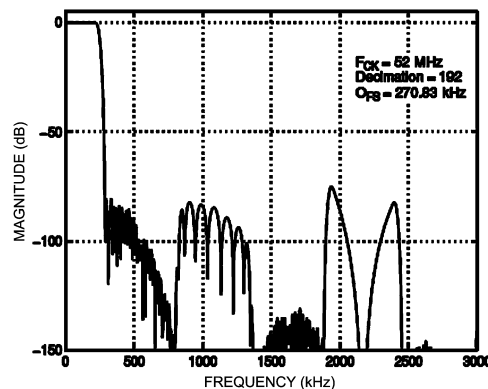

Figure 70. CIC, F1, & F2 STD frequency response

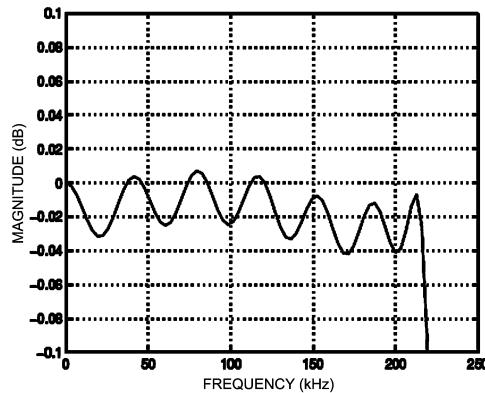

Figure 71. CIC, F1, & F2 STD Passband Flatness

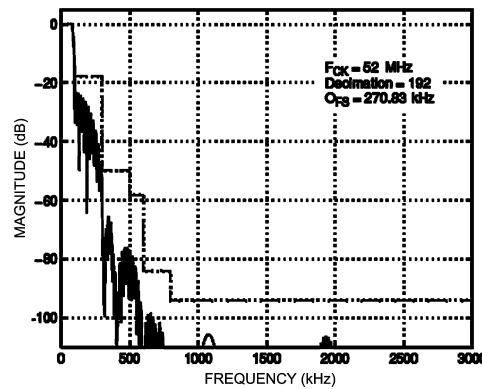

Figure 72. CIC, F1, & F2 GSM frequency response

This new decimation rate will maintain the same output bandwidth. The output bandwidth may only be changed in relation to the output sample rate by creating a new set of FIR filter coefficients. As the filter bandwidth decreases relative to the output sample rate, the CIC droop compensation performed by F1 may no longer be required.

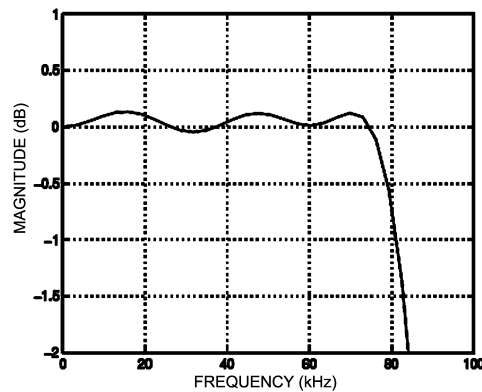

Figure 73. CIC, F1, & F2 GSM Passband Flatness

Overall Channel Gain

The overall gain of the chip is a function of the amount of decimation (N), the settings of the “SHIFT UP” circuit (SCALE), the GAIN setting, the sum of the F1 coefficients, and the sum of the F2 coefficients. The overall gain is shown below in Equation 6.

$$G_{DDC} = \frac{1}{2} (DEC + 1)^4 \cdot 2^{[SCALE - 44 - AGAIN \cdot (1 - EXP_INH)]} \cdot 2^{GAIN} \cdot G_{F1} \cdot G_{F2} \quad (6)$$

Where:

$$G_{F1} = \frac{\sum_{i=1}^{21} h_1(i)}{2^{16}} \quad (7)$$

and:

$$G_{F2} = \frac{\sum_{i=1}^{63} h_2(i)}{2^{16}} \quad (8)$$

It is assumed that the DDC output words are treated as fractional 2's complement words. The numerators of G_{F1} and G_{F2} equal the sums of the impulse response coefficients of F1 and F2, respectively. For the STD and GSM sets, G_{F1} and G_{F2} are nearly equal to unity. Observe that the *AGAIN* term in Equation 6 is cancelled by the DVGA operation so that the entire gain of the DRCS is independent of the DVGA setting when *EXP_INH*=0. The 1/2 appearing in Equation 6 is the result of the 6dB conversion loss in the mixer. For full-scale square wave inputs the 1/2 should be set to 1 to prevent signal distortion.

Data Latency and Group Delay

The LM97593 latency calculation assumes that the FIR filter latency will be equal to the time required for data to propagate through one half of the taps. The CIC filter provides 4N equivalent taps where N is the CIC decimation ratio. F1 and F2 provide 21 and 63 taps respectively. When these filters are reflected back to the input rate, the effective taps are increased by decimation. This results in a total of 151N taps.

The total latency is found by dividing the number of taps by 2 and adding pipeline delays. When the F2 decimation is 2 the latency is 80N. When the F2 decimation is 4 the latency is 82N. The LM97593 filters are linear phase filters so the group delay remains constant.

OUTPUT MODES

After processing by the DDC, the data is then formatted for output.

All output data is two's complement. The serial outputs power up in a tri-state condition and must be enabled when the chip is configured. Parallel outputs are enabled by the POUT_EN pin.

Output formats include truncation to 8 or 32 bits, rounding to 16 or 24 bits, and a 12-bit floating point format (4-bit exponent, 8-bit mantissa, 138dB numeric range). This function is performed in the OUTPUT CIRCUIT shown in Figure 74.

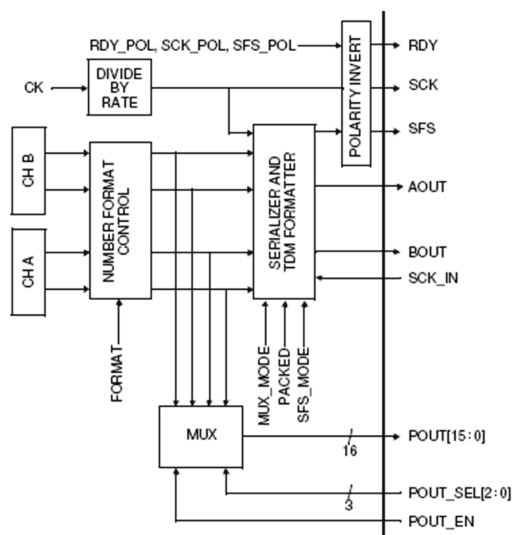
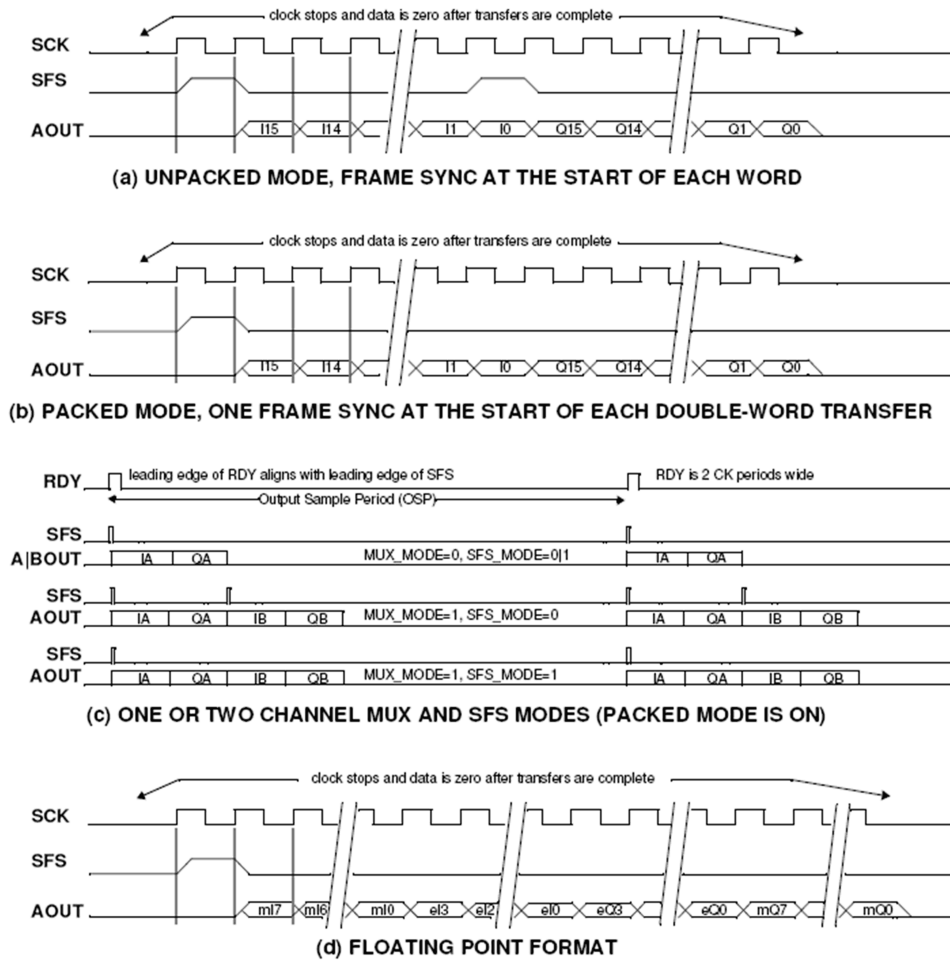

Figure 74. LM97593 output circuit

The channel outputs are accessible through serial output pins and a 16-bit parallel output port. The **RDY** pin is provided to notify the user that a new output sample period (OSP) has begun. OSP refers to the interval between output samples at the decimated output rate. For example, if the input rate (and clock rate) is 52 MHz and the overall decimation factor is 192 (N=48, F2 decimation=2) the OSP will be 3.69 microseconds which corresponds to an output sample rate of 270.833kHz. An OSP starts when a sample is ready and stops when the next one is ready.



Refer to Figure 13 for detailed timing information.

Figure 75. Serial output formats

Serial Outputs

The LM97593 provides a serial clock (**SCK**), a frame strobe (**SFS**) and two data lines (**AOUT** and **BOUT**) to output serial data. The MUX_MODE control register specifies whether the two channel outputs are transmitted on two separate serial pins, or multiplexed onto one pin in a time division multiplexed (TDM) format. Separate output pins are not provided for the I and Q halves of complex data. The I and Q outputs are always multiplexed onto the same serial pin. The I-component is output first, followed by the Q-component. By setting the PACKED mode bit to '1' a complex pair may be treated as a single double-wide word. The RDY signal is used to identify the first word of a complex pair of the TDM formatted output when the SFS_MODE bit is set to '0'. Setting SFS_MODE to '1' causes the LM97593 to output a single SFS pulse for each output period. This SFS pulse will be coincident with RDY and only a single SCK period wide. The TDM modes are summarized in Table 2.

Table 2. TDM Modes

SFS_MODE	MUX_MODE	SERIAL OUTPUTS	
		AOUT	BOUT
0	0	OUT _A	OUT _B
	1	OUT _A , OUT _B	LOW
1	0	OUT _A	OUT _B
	1	OUT _A , OUT _B	LOW

The serial outputs use the format shown in Figure 75. Figure 75(a) shows the standard output mode (the PACKED mode bit is low). The chip clocks the frame and data out of the chip on the rising edge of **SCK** (or falling edge if the **SCK_POL** bit in the input control register is set high).

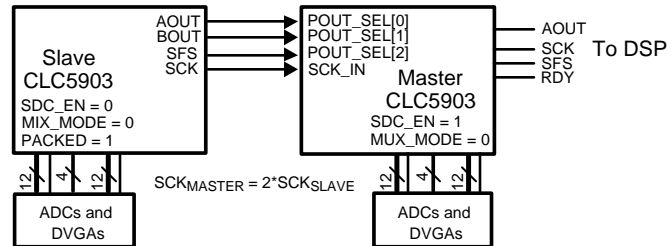

Figure 76. Serial Daisy-Chain Mode

Data should be captured on the falling edge of **SCK** (rising if **SCK_POL**=1). The chip sends the I data first by setting **SFS** high (or low if **SFS_POL** in the input control register is set high) for one clock cycle, and then transmitting the data, MSB first, on as many **SCK** cycles as are necessary. Without a pause, the Q data is transferred next as shown in Figure 75(a). If the **PACKED** control bit is high, then the I and Q components are sent as a double length word with only one **SFS** strobe as shown in Figure 75(b). If both channels are multiplexed out the same serial pin, then the subsequent I/Q channel words will be transmitted immediately following the first I/Q pair as shown in Figure 75(c). Figure 75(c) also shows how **SFS_MODE**=1 allows the **SFS** signal to be used to identify the A and B channels in the TDM serial transmission. The serial output rate is programmed by the **RATE** register to **CK** divided by 1, 2, 4, 8, 16, or 32. The serial interface will not work properly if the programmed rate of **SCK** is insufficient to clock out all the bits in one **OSP**.

Serial Port Daisy-Chain Mode

Two LM97593s can be connected in series so that a single DSP serial port can receive four DDC output channels. This mode is enabled by setting the **SDC_EN** bit to '1' on the serial daisy-chain (SDC) master. The SDC master is the LM97593 which is connected to the DSP while the SDC slave's serial output drives the master. The SDC master's **RATE** register must be set so that its **SCK** rate is twice that of the SDC slave, the SDC master must have **MUX_MODE**=1, the SDC slave must have **MUX_MODE**=0 and **PACKED**=1, and both chips must come out of a **MR** or **SI** event within four **CK** periods of each other. In this configuration, the master's serial output data is shifted out to the DSP and then the slave's serial data is shifted out. All the serial output data will be muxed onto the master's **AOUT** pin as shown in Figure 76.

Serial Port Output Number Formats

Several numeric formats are selectable using the **FORMAT** control register. The I/Q samples can be rounded to 16 or 24 bits, or truncated to 8 bits. The packed mode works as described above for these fixed point formats. A floating point format with 138dB of dynamic range in 12 bits is also provided. The mantissa (m) is 8 bits and the exponent (e) is 4 bits. The MSB of each segment is transmitted first. When the packed mode is selected, the I/Q samples are packed regardless of the state of **MUX_MODE**, and the data is sent as mI/eI/eQ/ mQ which allows the two exponents to form an 8-bit word. This is shown in Figure 75(d). For all formats, once the defined length of the word is complete, **SCK** stops toggling.

Parallel Outputs

Output data from the channels can also be taken from a 16-bit parallel port. A 3-bit word applied to the **POUT_SEL[2:0]** pins determines which 16-bit segment is multiplexed to the parallel port. Table 3 defines this mapping. To allow for bussing of multiple chips, the parallel port is tri-stated unless **POUT_EN** is low. The **RDY** signal indicates the start of an **OSP** and that new data is ready at the parallel output. The user has one **OSP** to cycle through whichever registers are needed. The **RATE** register must be set so that each **OSP** is at least 5 **SCK** periods.

Parallel Port Output Numeric Formats

The I/Q samples can be rounded to 16 or 24 bits or the full 32 bit word can be read. By setting the word size to 32 bits it is possible to read out the top 16-bits and only observe the top 8 bits if desired. Additionally, the output samples can be formatted as floating point numbers with an 8-bit mantissa and a 4 bit exponent. For the fixed-point formats, the valid bits are justified into the MSBs of the registers of [Table 3](#) and

Table 3. Register Selection for Parallel Output

POUT_SEL	Normal Register Contents	Floating Point Register Contents
0	IA upper 16-bits	0000/eIA/mIA
1	IA lower 16-bits	0x0000
2	QA upper 16-bits	0000/eQA/mQA
3	QA lower 16-bits	0x0000
4	IB upper 16-bits	0000/eIB/mIB
5	B lower 16-bits	0x0000
6	QB upper 16-bits	0000/eQB/mQB
7	QB lower 16-bits	0x0000

all other bits are set to zero. For the floating point format, the valid bits are placed in the upper 16-bits of the appropriate channel register using the format 0000/el/ml for the I samples.

AGC

The LM97593 AGC processor monitors the output level of the ADC and servos it to the desired setpoint. The ADC input is controlled by the DVGA to maintain the proper setpoint level. DVGA operation results in a compression of the signal through the ADC. The DVGA signal compression is reversed in the LM97593 to provide > 120dB of linear dynamic range. This is illustrated in [Figure 77](#).

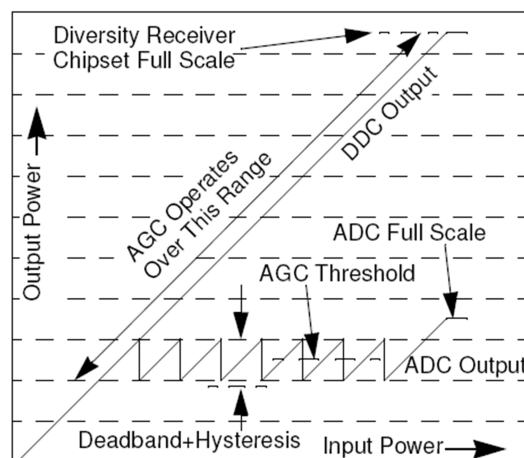

Figure 77. Output Gain Scaling vs. Input Signal

In order to use the AGC, the DRCS Control Panel software may be used to calculate the programmable parameters. To generate these parameters, only the desired setpoint, deadband+ hysteresis, and loop time constant need to be supplied. All subsequent calculations are performed by the software. Complete details of the AGC operation are provided in an appendix.

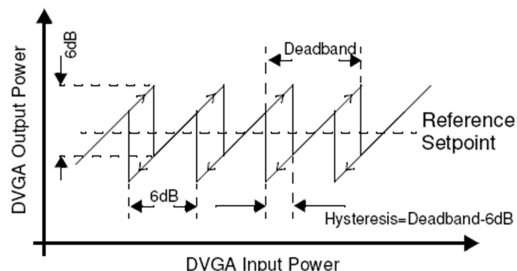

Figure 78. AGC Setup

AGC setpoint and deadband are illustrated in Figure 78. The loop time constant is a measure of how fast the loop will track a changing signal. Values down to approximately 1.0 microsecond will be stable with the second order LC noise filter. Since the DVGA operates with 6dB steps the deadband should always be greater than 6dB to prevent oscillation. An increased deadband value will reduce the amount of AGC operation. A decreased deadband value will increase the amount of AGC operation but will hold the ADC output closer to the setpoint. The threshold should be set so that transients do not cause sustained overrange at the ADC inputs. The threshold setting can also be used to set the ADC input near its optimal performance level.

The AGC will free run when AGC_HOLD_IC is set to '0'. It may be set to a fixed gain by setting AGC_HOLD_IC to '1' after programming the desired gain in the AGC_IC_A and AGC_IC_B registers. Allowing the AGC to free run should be appropriate for most applications.

Programming the AGC_COMB_ORD register allows the AGC power detector bandwidth to be reduced if desired. This will tend to improve the power detector's ability to reject the signal carrier frequency and reduce overall AGC activity. Figure 80 shows the power detector response.

The analog gain change from the DVGA must be compensated by the "Float To Fixed" converter after the appropriate delay. This delay can be adjusted by the EXT_DELAY register value to make sure the analog gain change is properly compensated in the digital domain.

Figure 79 shows the internal clock latency paths related to the DVGA and "Float To Fixed" timing compensation. In this diagram registers are represented by z^{-N} where N is the sample delay in ADC clock periods. Following the path from the output of the AGC integrator through the DVGA, bandpass filter, ADC and internal register delays adds up to 6 clocks prior to the "Float To Fixed" converter excluding the bandpass filter and ADC. Following the path from the AGC integrator to the "Float To Fixed" is also 6 clocks when EXT_DELAY = 0. The value programmed in EXT_DELAY should be set to the pipeline latency of the ADC plus the latency of the bandpass filter (typically one clock). If ASTROBE and BSTROBE are not used then subtract one from the resulting total latency.

The LM97593 includes an integrated ADC with a pipeline latency of 7 clocks. Adding one additional clock period for the bandpass filter requires EXT_DELAY = 7 when the DVGA ASTROBE and BSTROBE signals are used, otherwise, program EXT_DELAY = 6. In most cases ASTROBE and BSTROBE signals are not used so EXT_DELAY is typically set to 6.

More accurate time alignment may improve the equalizer / demodulator performance for EDGE modulated signals and other signals with a large AM component.

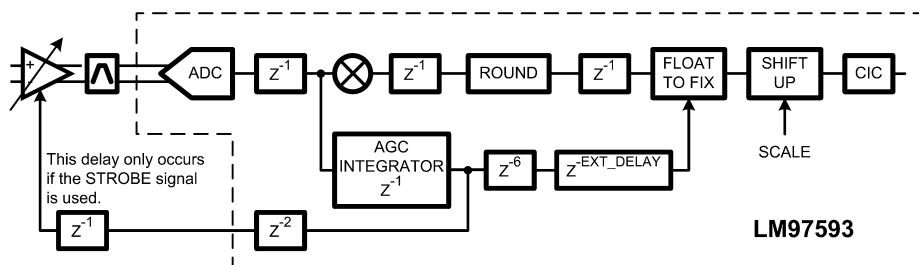

Figure 79. Function controlled by EXT_DELAY register

POWER MANAGEMENT

The LM97593 can be placed in a low power (static) state by stopping the input clock and setting the PD pin high. To prevent this from placing the LM97593 into unexpected states, the **SI** pin of the LM97593 should be asserted prior to disabling the input clock and held asserted until the input clock has returned to a stable condition.

TESTABILITY

JTAG Boundary Scan

The LM97593 supports IEEE 1149.1 compliant JTAG Boundary Scan for the I/O's. The following pins are used:

TRST	(test reset)
TMS	(test mode select)
TDI	(test data in)
TDO	(test data out)
TCK	(test clock)

The following JTAG instructions are supported:

Instruction	Description
BYPASS	Connects TDI directly to TDO
EXTEST	Enables the test access port controller to drive the outputs
IDCODE	Connects the 32-bit ID register to TDO
SAMPLE/PRELOAD	Allows the test access port to sample the device inputs and preload test output data
HIGHZ	Tri-states the outputs

The JTAG Boundary Scan can be used to verify printed circuit board continuity at the system level.

Test Register

The user is able to program a value into TEST_REG and substitute this for the normal channel inputs from the **AIN/ BIN** pins by selecting it with the crossbar. With the NCO frequency set to zero this allows the DDCs and the output interface of the chip to be verified. Also, the AGC loop can be opened by setting AGC_HOLD_IC high and setting the gain of the DVGA by programming the appropriate value into the AGC_IC_A/B register.

Debug Access Port

Real-time access to the following signals is provided by configuring the control interface debug register:

- NCO sine and cosine outputs
- data after round following mixers
- data before F1 and F2
- data after CIC filter within the AGC

The access points are multiplexed to a 20-bit parallel output port which is created from signal pins **POUT[15:0]**, **AOUT**, **BOUT**, **SFS**, and **RDY** according to the table below:

Normal Mode Pin	Debug Mode Pin
POUT[15:0]	DEBUG[19:4]
RDY	DEBUG[3]
SFS	DEBUG[2]
AOUT	DEBUG[1]
BOUT	DEBUG[0]

SCK will be set to the proper strobe rate for each debug tap point. **POUT_EN** and **PSEL[2:0]** have no effect in Debug Mode. The outputs are turned on when the Debug Mode bit is set. Normal serial outputs are also disabled.

CONTROL REGISTERS

The chip is configured and controlled through the use of 8-bit control registers. These registers are accessed for reading or writing using the control bus pins (\overline{CE} , \overline{RD} , \overline{WR} , A[7:0], and D[7:0]) described in [CONTROL INTERFACE](#).

The two sets of FIR coefficients are overlaid at the same memory address. Use the PAGE_SEL registers to access the second set of coefficients.

The register names and descriptions are listed below in [Control Register Addresses and Defaults](#). A quick reference table is provided in the [Condensed LM97593 Address Map](#).

Control Register Addresses and Defaults

Register Name	Width	Type	Default ⁽¹⁾	Addr	Bit	Description
DEC	11b	R/W	7	0(LSBs) 1(MSBs)	7:0 2:0	CIC decimation control. N=DEC+1. Valid range is from 7 to 2047. Format is an unsigned integer. This affects both channels.
DEC_BY_4	1b	R/W	0	1	4	Controls the decimation factor in F2. 0=Decimate by 2. 1=Decimate by 4. This affects both channels.
SCALE	6b	R/W	0	2	5:0	CIC SCALE parameter. Format is an unsigned integer representing the number of left bit shifts to perform on the data prior to the CIC filter. Valid range is from 0 to 40. This affects both channels.
GAIN_A	3b	R/W	0	3	2:0	Value of left bit shift prior to F1 for channel A.
GAIN_B	3b	R/W	0	4	2:0	Value of left bit shift prior to F1 for channel B.
RATE	1B	R/W	1	5	7:0	Determines rate of serial output clock. The output rate is $F_{CK}/(RATE+1)$. Unsigned integer values of 0, 1, 3, 7, 15, and 31 are allowed.
SOUT_EN	1b	R/W	0	6	0	Enables the serial output pins AOUT , BOUT , SCK , and SFS . 0=Tristate. 1=Enabled.
SCK_POL	1b	R/W	0	6	1	Determines polarity of the SCK output. 0= AOUT , BOUT , and SFS change on the rising edge of SCK (capture on falling edge). 1=They change on the falling edge of SCK.
SFS_POL	1b	R/W	0	6	2	Determines polarity of the SFS output. 0=Active High. 1=Active Low.
RDY_POL	1b	R/W	0	6	3	Determines polarity of the RDY output. 0=Active High. 1=Active Low.
MUX_MODE	1b	R/W	0	6	4	Determines the mode of the serial outputs. 0=Each channel is output on its respective pin, 1=Both channels are multiplexed and output on AOUT .
PACKED	1b	R/W	0	6	5	Controls when SFS goes active. 0= SFS pulses prior to the start of the I and the Q words. 1= SFS pulses only once prior to the start of each I/Q sample pair (i.e. the pair is treated as a double-sized word) The I word precedes the Q word.
FORMAT	2b	R/W	0	6	7:6	Determines output number format. 0=Truncate serial output to 8 bits. Parallel output is truncated to 32 bits. 1=Round both serial and parallel to 16-bits. All other bits are set to 0. 2=Round both serial and parallel to 24-bits. All other bits are set to 0. 3=Output floating point. 8-bit mantissa, 4-bit exponent. All other bits are set to 0.
FREQ_A	4B	R/W	0	7-10	7:0	Frequency word for channel A. Format is a 32-bit, 2's complement number spread across 4 registers. The LSBs are in the lower registers. The NCO frequency F is $F/F_{CK}=FREQ_A/2^{32}$.

(1) These are the default values set by a master reset (\overline{MR}). Sync in (\overline{SI}) will not affect any of these values.

Register Name	Width	Type	Default ⁽¹⁾	Addr	Bit	Description
PHASE_A	2B	R/W	0	11-12	7:0	Phase word for channel A. Format is a 16-bit, unsigned magnitude number spread across 2 registers. The LSBs are in the lower registers. The NCO phase PHI is $PHI=2*\pi*PHASE_A/2^{16}$.
FREQ_B	4B	R/W	0	13-16	7:0	Frequency word for channel B. Format is a 32-bit, 2's complement number spread across 4 registers. The LSBs are in the lower registers. The NCO frequency F is $F/F_{CK}=FREQ_B/2^{32}$.
PHASE_B	2B	R/W	0	17-18	7:0	Phase word for channel B. Format is a 16-bit, unsigned magnitude number spread across 2 registers. The LSBs are in the lower registers. The NCO phase PHI is $PHI=2*\pi*PHASE_B/2^{16}$.
A_SOURCE	2	R/W	0	19	1:0	0=Select A IN as channel input source. 1=Select B IN. 2=3=Select TEST_REG as channel input source.
B_SOURCE	2	R/W	1	19	3:2	0=Select A IN as channel input source. 1=Select B IN. 2=3=Select TEST_REG as channel input source.
EXP_INH	1b	R/W	0	20	0	0=Allow exponent to pass into FLOAT TO FIXED converter. 1=Force exponent in DDC channel to a 7 (maximum digital gain). This affects both channels.
Reserved	1b	R/W	1	20	1	AGC_FORCE on the CLC5902. Do not use.
Reserved	1b	R/W	0	20	2	AGC_RESET_EN on the CLC5902. Do not use.
AGC_HOLD_IC	1b	R/W	0	20	3	0=Normal closed-loop operation. 1=Hold integrator at initial condition. This affects both channels.
AGC_LOOP_GAIN	2b	R/W	0	20	4:5	Bit shift value for AGC loop. Valid range is from 0 to 3. This affects both channels.
Reserved	2B	R/W	0	21-22	7:0	AGC_COUNT on the CLC5902. Do not use.
AGC_IC_A	1B	R/W	0	23	7:0	AGC fixed gain for channel A. Format is an 8-bit, unsigned magnitude number. The channel A DVGA gain will be set to the inverted three MSBs.
AGC_IC_B	1B	R/W	0	24	7:0	AGC fixed gain for channel B. Format is an 8-bit, unsigned magnitude number. The channel B DVGA gain will be set to the inverted three MSBs.
AGC_RB_A	1B	R	0	25	7:0	AGC integrator readback value for channel A. Format is an 8-bit, unsigned magnitude number. The user can read the magnitude MSBs of the channel A integrator from this register.
AGC_RB_B	1B	R	0	26	7:0	AGC integrator readback value for channel B. Format is an 8-bit, unsigned magnitude number. The user can read the magnitude MSBs of the channel B integrator from this register.
TEST_REG	14b	R/W	0	27(LSBs) 28(MSBs)	7:0 5:0	Test input source. Instead of processing values from the A B IN pins, the value from this location is used instead. Format is 14-bit 2s complement number spread across 2 registers.
Reserved	1B	-	-	29	7:0	For future use.
Reserved	1B	-	-	30	7:0	For future use
DEBUG_EN	1b	R/W	0	31	0	0=Normal. 1=Enables access to the internal probe points.

Register Name	Width	Type	Default ⁽¹⁾	Addr	Bit	Description
DEBUG_TAP	5b	R/W	0	31	5:1	Selects internal node tap for debug. 0 selects F1 output for BI, 20 bits 1 selects F1 output for BQ, 20 bits 2 selects F1 output for AQ, 20 bits 3 selects F1 output for AI, 20 bits 4 selects F1 input for BI, 20 bits 5 selects F1 input for BQ, 20 bits 6 selects F1 input for AI, 20 bits 7 selects F1 input for AQ, 20 bits 8 selects NCO A, cosine output. 17 bits, 3 LSBs are 0. 9 selects NCO A, sine output, 17 bits, 3 LSBs are 0. 10 selects NCO B, cosine output, 17 bits, 3 LSBs are 0. 11 selects NCO B, sine output, 17 bits, 3 LSBs are 0. 12 selects NCO AI, rounded output, 15 bits, 5 LSBs are 0. 13 selects NCO AQ, rounded output, 15 bits, 5 LSBs are 0. 14 selects NCO BI, rounded output, 15 bits, 5 LSBs are 0. 15 selects NCO BQ, rounded output, 15 bits, 5 LSBs are 0. 16 selects AGC CIC filter output. 9 MSBs from ch A, next 9 bits from ch B, 2 LSBs are 0. 17-31 Reserved.
DITH_A	1b	R/W	1	31	6	0=Disable NCO dither source for channel A. 1=Enable.
DITH_B	1b	R/W	1	31	7	0=Disable NCO dither source for channel B. 1=Enable.
AGC_TABLE	32B	R/W	0	128-159	7:0	RAM space that defines key AGC loop parameters. Format is 32 separate 8-bit, 2's complement numbers. This is common to both channels.
F1_COEFF	22B	R/W	0	160-181	7:0	Coefficients for F1. Format is 11 separate 16-bit, 2's complement numbers, each one spread across 2 registers. The LSBs are in the lower registers. For example, coefficient h0[7:0] is in address 160, h0[15:8] is in address 161, h1[7:0] is in address 162, h1[15:8] is in address 163. PAGE_SEL_F1=1 maps these addresses to coefficient memory B.
F2_COEFF	64B	R/W	0	182-245	7:0	Coefficients for F2. Format is 32 separate 16-bit, 2's complement numbers, each one spread across 2 registers. The LSBs are in the lower registers. For example, coefficient h0[7:0] is in address 182, h0[15:8] is in address 183, h1[7:0] is in address 184, h1[15:8] is in address 185. PAGE_SEL_F2=1 maps these addresses to coefficient memory B.
COEF_SEL_F1A	1b	R/W	0	246	0	Channel A F1 coefficient select register. 0=memory A, 1=memory B.
COEF_SEL_F1B	1b	R/W	0	246	1	Channel B F1 coefficient select register. 0=memory A, 1=memory B.
PAGE_SEL_F1	1b	R/W	0	246	2	F1 coefficient page select register. 0=memory A, 1=memory B.
COEF_SEL_F2A	1b	R/W	0	247	0	Channel A F2 coefficient select register. 0=memory A, 1=memory B.
COEF_SEL_F2B	1b	R/W	0	247	1	Channel B F2 coefficient select register. 0=memory A, 1=memory B.
PAGE_SEL_F2	1b	R/W	0	247	2	F2 coefficient page select register. 0=memory A, 1=memory B.
SFS_MODE	1b	R/W	0	248	0	0= SFS asserted at the start of each output word when PACKED=1 or each I/Q pair when PACKED=0, 1= SFS asserted at the start of each output sample period.
SDC_EN	1b	R/W	0	248	1	0=normal serial mode, 1=serial daisy-chain master mode.
AGC_COMB_ORD	2b	R/W	0	249	1:0	Enable reduced bandwidth AGC power detector. 0=2 nd -order decimate-by-eight CIC, 1=1-tap comb added to CIC, 2=4-tap comb added to CIC.
EXT_DELAY	5b	R/W	0	249	6:2	Number of CK period delays needed to align the DVGA gain step with the digital gain compensation step. Set this register to 7 if ASTROBE and BSTROBE are not used. Otherwise set to 8.

Condensed LM97593 Address Map

Register Name	Addr	Addr Hex	Bit7	Bit6	Bit5	Bit4	Bit3	Bit2	Bit1	Bit0
DEC	0	0x00	Dec7	Dec6	Dec5	Dec4	Dec3	Dec2	Dec1	Dec0
DEC_BY_4	1	0x01				DecBy4		Dec10	Dec9	Dec8
SCALE	2	0x02			Sc5	Sc4	Sc3	Sc2	Sc1	Sc0
GAIN_A	3	0x03						GA2	GA1	GA0
GAIN_B	4	0x04						GB2	GB1	GB0
RATE	5	0x05	Rate7	Rate6	Rate5	Rate4	Rate3	Rate2	Rate1	Rate0
SERIAL_CTRL	6	0x06	FMT1	FMT0	Packed	MuxMode	RDY_POL	SFS_POL	SCK_POL	SOUT_EN
FREQ_A	7	0x07	FA7	FA6	FA5	FA4	FA3	FA2	FA1	FA0
	8	0x08	FA15	FA14	FA13	FA12	FA11	FA10	FA9	FA8
	9	0x09	FA23	FA22	FA21	FA20	FA19	FA18	FA17	FA16
	10	0x0A	FA31	FA30	FA29	FA28	FA27	FA26	FA25	FA24
PHASE_A	11	0x0B	PA7	PA6	PA5	PA4	PA3	PA2	PA1	PA0
	12	0x0C	PA15	PA14	PA13	PA12	PA11	PA10	PA9	PA8
FREQ_B	13	0x0D	FB7	FB6	FB5	FB4	FB3	FB2	FB1	FB0
	14	0x0E	FB15	FB14	FB13	FB12	FB11	FB10	FB9	FB8
	15	0x0F	FB23	FB22	FB21	FB20	FB19	FB18	FB17	FB16
	16	0x10	FB31	FB30	FB29	FB28	FB27	FB26	FB25	FB24
PHASE_B	17	0x11	PB7	PB6	PB5	PB4	PB3	PB2	PB1	PB0
	18	0x12	PB15	PB14	PB13	PB12	PB11	PB10	PB9	PB8
Source	19	0x13					BS1	BS0	AS1	AS0
AGC_CTRL	20	0x14			AgcLG1	AgcLG0	AgcHldIC	Reserved	Reserved	Explnh
AGC_COUNT	21	0x15	Reserved	Reserved	Reserved	Reserved	Reserved	Reserved	Reserved	Reserved
	22	0x16	Reserved	Reserved	Reserved	Reserved	Reserved	Reserved	Reserved	Reserved
AGC_IC_A	23	0x17	AgclcA7	AgclcA6	AgclcA5	AgclcA4	AgclcA3	AgclcA2	AgclcA1	AgclcA0
AGC_IC_B	24	0x18	AgclcB7	AgclcB6	AgclcB5	AgclcB4	AgclcB3	AgclcB2	AgclcB1	AgclcB0
AGC_RB_A	25	0x19	AgcRbA7	AgcRbA6	AgcRbA5	AgcRbA4	AgcRbA3	AgcRbA2	AgcRbA1	AgcRbA0
AGC_RB_B	26	0x1A	AGCRbB7	AGCRbB6	AGCRbB5	AGCRbB4	AGCRbB3	AGCRbB2	AGCRbB1	AGCRbB0
TEST_REG	27	0x1B	Test7	Test6	Test5	Test4	Test3	Test2	Test1	Test0
	28	0x1C			Test13	Test12	Test11	Test10	Test9	Test8
DEBUG	31	0x1F	DITH_B	DITH_A	TapSel4	TapSel3	TapSel2	TapSel1	TapSel0	DebugEnable
AGC_TABLE	128	0x80	The AGC Table loads from the low address to the high address in this order: "1st location, 2nd location..."							
	159	0x9F								
F1_COEFF	160	0xA0	The FIR Coefficients load from the low address to the high address in this order: "1st location low byte, 1st location high byte, 2nd location..." The Page Select bits determine which set of coefficient memory is written.							
	181	0xB5								
F2COEFF	182	0xB6								
	245	0xF5								
F1_CTRL	246	0xF6						PgSelF1	CfSelF1B	CfSelF1A
F2_CTRL	247	0xF7						PgSelF2	CfSelF2B	CfSelF2A
SERIAL_CTRL2	248	0xF8							SdcEn	SfsMode
AGC_CTRL2	249	0xF9		ExtDelay4	ExtDelay3	ExtDelay2	ExtDelay1	ExtDelay0	CombOrd1	CombOrd0

AGC Theory of Operation

A block diagram of the AGC is shown in Figure 81. The DVGA interface comprises four pins for each of the channels. The first three pins of this interface are a 3-bit binary word that controls the DVGA gain in 6dB steps (**AGAIN**). The final pin is **ASTROBE** which allows the **AGAIN** bits to be latched into the DVGA's register. A key feature of the **ASTROBE**, illustrated Figure 82, is that it toggles only if the data on **AGAIN** has changed from the previous cycle. Not shown is that **ASTROBE** and **BSTROBE** are independent. For example, **ASTROBE** only toggles when **AGAIN** has changed. **BSTROBE** will not toggle because **AGAIN** has changed. This is done to minimize unnecessary digital noise on the sensitive analog path through the DVGA. **ASTROBE** and **BSTROBE** are asserted during **MR** and **SI** to properly initialize the DVGAs.

The absolute value circuit and the 2-stage, decimate-by-8 CIC filter comprise the power detection part of the AGC. The power detector bandwidth is set by the CIC filter to $F_{CK}/8$. The absolute value circuit doubles the effective input frequency. This has the effect of reducing the power detector bandwidth from $F_{CK}/8$ to $F_{CK}/16$.

For a full-scale sinusoidal input, the absolute value circuit output is a dc value of $511 \cdot (2/\pi)$. Because the absolute value circuit also generates undesired even harmonic terms, the CIC filter (response shown in Figure 80) is required to remove these harmonics. The first response null occurs at $F_{CK}/8$, where F_{CK} is the clock frequency, and the response magnitude is at least 25dB below the dc value from $F_{CK}/10$ to $9F_{CK}/10$. Because the 2nd harmonic from the absolute value circuit is about 10dB below the dc value this means that the ripple in the detected level is about 0.7dB or less for input frequencies between $F_{CK}/20$ to $19F_{CK}/20$. Setting the **AGC_COMB_ORD** register to either 1 or 2 will narrow the power detector's bandwidth as shown in Figure 80.

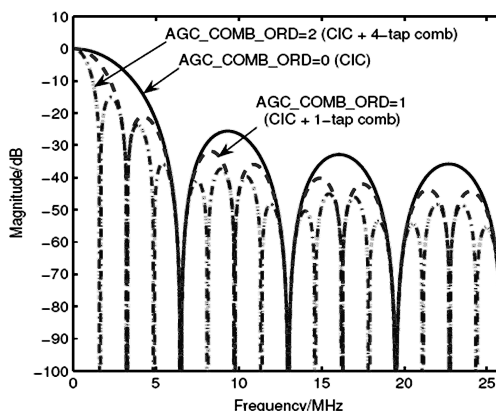

Figure 80. Power detector filter response, 52 MHz

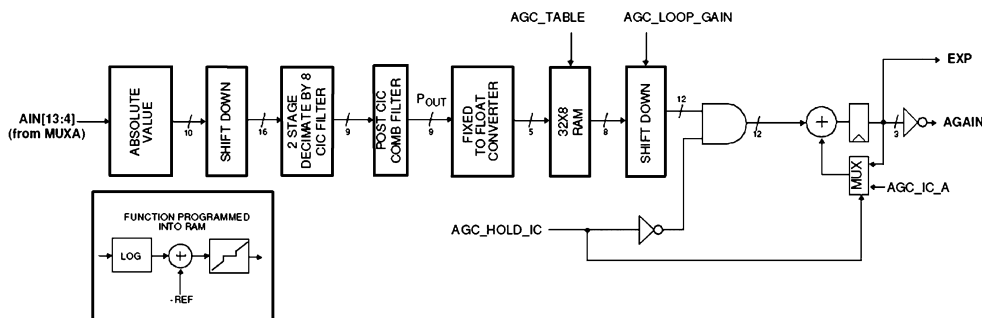
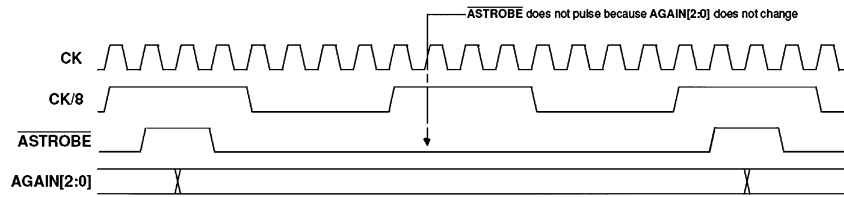

Figure 81. LM97593 AGC circuit, Channel A



Refer to [Figure 7](#) for detailed timing information.

Figure 82. Timing diagram for AGC/DVGA interface, Channel A

The “FIXED TO FLOAT CONVERTER” takes the fixed point 9-bit output from the CIC filter and converts it to a “floating point” number. This conversion is done so that the 32 values in the RAM can be uniformly assigned (dB scale) to detected power levels (54 dB range). This provides a resolution of 1.7dB between detected power levels. The truth table for this converter is given in [Table 4](#). The upper three bits of the output represent the exponent (e) and the lower 2 are the mantissa (m). The exponent is determined by the position of the leading ‘1’ out of the CIC filter. An output of ‘001XX’ corresponds to a leading ‘1’ in bit 2 (LSB is bit 0). The exponent increases by one each time the leading ‘1’ advances in bit position. The mantissa bits are the two bits that follow the leading ‘1’. If we define E as the decimal value of the exponent bits and M as the decimal value of the mantissa bits, the output of the CIC filter, P_{OUT}, corresponding to a given “FIXED TO FLOAT CONVERTER” output is:

$$P_{OUT} = [4 * \min(E,1) + M] \cdot 2^{(\max(E,1)-1)}, E \geq 1. \quad (9)$$

The max() and min() operators account for row 1 of [Table 4](#) which is a special case because M=P_{OUT}. [Equation 9](#) associates each address of the RAM with a CIC filter output.

Table 4. Fixed to Float Converter Truth Table

INPUT	OUTPUT (eeemm)
0-3	000XX
4-7	001XX
8-15	010XX
16-31	011XX
32-63	100XX
64-127	101XX
128-255	110XX
256-511	111XX

As shown in [Figure 81](#), the 32X8 RAM look-up table implements the functions of log converter, reference subtraction, error amplifier, and deadband. The user must build each of these functions by constructing a set of 8-bit, 2’s complement numbers to be loaded into the RAM. Each of these functions and how to construct them are discussed in the following paragraphs.

A log conversion is done in order to keep the loop gain independent of operating point. To see why this is beneficial, the control gain of the DVGA computed without log conversion is:

$$K'_{DVGA} = \frac{\partial}{\partial G} (v_i \cdot 2^{(G-G_o)}),$$

$$= -v_i \cdot \ln(2) \cdot 2^{(G-G_o)}$$

where

- G is the decimal equivalent of GAIN
- G_o accounts for the DVGA gain in excess of unity

(10)

This equation assumes that the DVGA gain control polarity is positive as is the case for the CLC5526. The gain around the entire loop must be negative. Observe in [Equation 10](#) that the control gain is dependent on operating point G. If we instead compute the control gain with log conversion then:

$$\begin{aligned} K_{DVGA} &= \frac{\partial}{\partial G} [20 \cdot \log(v_i \cdot 2^{(G-G_o)})], \\ &= -6.02, \end{aligned} \tag{11}$$

which is no longer operating-point dependent. The log function is constructed by computing the CIC filter output associated with each address ([Equation 12](#)) and converting these to dB. Full scale (dc signal) is $20\log(511)=54\text{dB}$.

The reference subtraction is constructed by subtracting the desired loop servo point (in dB) from the table values computed in the previous paragraph. For example, if it is desired that the DVGA servo the ADC input level (sinusoidal signal) to -6dBFS, the number to subtract from the data is:

$$20\log\left(\frac{511}{2} \cdot \frac{2}{\pi}\right) = 44 \text{ dB}. \tag{12}$$

The table data will then cross through zero at the address corresponding to this reference level. A deadband wider than 6dB should then be constructed symmetrically about this point. This prevents the loop from hunting due to the 6dB gain steps of the DVGA. Any deadband in excess of 6dB appears as hysteresis in the servo point of the loop as illustrated in [Figure 78](#). The deadband is constructed by loading zeros into those addresses on either side of the one which corresponds to the reference level.

The last function of the RAM table is that of error amplification. All the operations preceding this one gave a table slope $S_{RAM} = 1$. This must now be adjusted in order to control the time constant of the loop given by:

$$\tau = \frac{8}{F_{CK}} \left(\frac{1}{G_L} + \frac{1}{2} \right) \tag{13}$$

The term G_L in this equation is the loop gain:

$$G_L = -6.02 \cdot S_{RAM} \cdot 2^{(AGC_LOOP_GAIN-8)}. \tag{14}$$

The design equations are obtained by solving [Equation 13](#) for G_L and [Equation 14](#) for S_{RAM} . AGC_LOOP_GAIN is a control register value that determines the number of bits to shift the output of the RAM down by. This allows some of the loop gain to be moved out of the RAM so that the full output range of the table is utilized but not exceeded. The valid range for AGC_LOOP_GAIN is from 0 to 3 which corresponds to a 0 to 3 bit shift to the left.

An example set of numbers to implement a loop having a reference of 6dB below full scale, a deadband of 8dB, and a loop gain of 0.108 is:

```
-102 -102 -88 -80 -75 -70 -66
-63 -61 -56 -53 -50
-47 -42 -39 -36 -33 -29 -25
-22 -19 -15 -11 -0
0 0 0 0 13 17 20
```

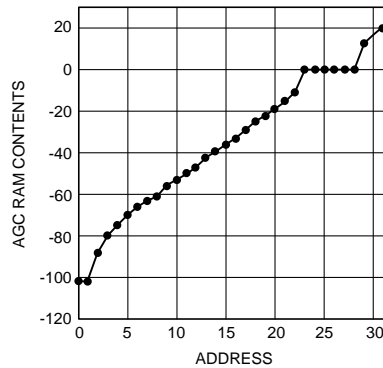

Figure 83. Example of programmed RAM contents

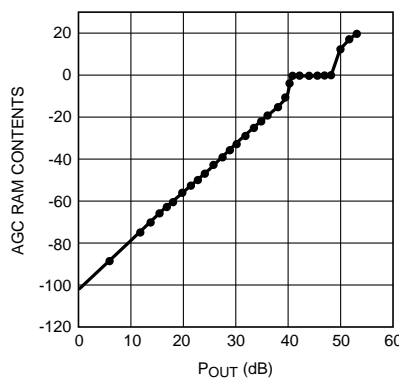

Figure 84. Example of programmed RAM contents

Table 5. 15-bit Mixer Output Alignment into the 22-bit SHIFT-UP Based On EXP

AGAIN ^a	EXP ^b	Input ^c	21 ^d	20	19	18	17	16	15	14	...	8	7	6	5	4	3	2	1	0
000 = -12dB	111 = +0dB	-12dB	14	13	12	11	10	9	8	7	...	1	0	L	L	L	L	L	L	L
001 = -6dB	110 = -6dB	-12dB	14	14	13	12	11	10	9	8	...	2	1	0	L	L	L	L	L	L
010 = 0dB	101 = -12dB	-12dB	14	14	14	13	12	11	10	9	...	3	2	1	0	L	L	L	L	L
011 = +6dB	100 = -18dB	-12dB	14	14	14	14	13	12	11	10	...	4	3	2	1	0	L	L	L	L
100 = +12dB	011 = -24dB	-12dB	14	14	14	14	14	13	12	11	...	5	4	3	2	1	0	L	L	L
101 = +18dB	010 = -30dB	-12dB	14	14	14	14	14	14	13	12	...	6	5	4	3	2	1	0	L	L
110 = +24dB	001 = -36dB	-12dB	14	14	14	14	14	14	14	13	...	7	6	5	4	3	2	1	0	L
111 = +30dB	000 = -42dB	-12dB	14	14	14	14	14	14	14	14	...	8	7	6	5	4	3	2	1	0

These values are shown with respect to the table addresses in [Figure 83](#), and the CIC filter output P_{OUT} in [Figure 84](#). For a 52MHz clock rate and AGC_LOOP_GAIN=2, these values result in a loop time constant of 1.5 μ s.

The error signal from the loop gain “SHIFT DOWN” circuit is gated into the loop integrator. A MUX within the integrator feedback allows the integrator to be initialized to the value loaded into AGC_IC_A (channel B can be set independently). The top eight bits of the integrator output can also be read back over the microprocessor interface from the AGC_RB_A (or AGC_RB_B) register. The top 3 bits become **AGAIN** and are output along with the **ASTROBE** signal on the DVGA interface pins. The valid range of **AGAIN** is from 0 to 7 which corresponds to a valid range of 0 to $2^{11}-1$ for the 11-bit, 2’s complement integrator output from which **AGAIN** is derived. This is illustrated in [Figure 85](#). The integrator saturates at these limits to prevent overshoots as the integrator attempts to enter the valid range. The **AGAIN** value is inverted (**EXP**) and used to adjust the gain of the incoming signal to provide a linear output dynamic range. The relationship between the DVGA analog gain (**AGAIN**) and the “FIXED TO FLOAT CONVERTER” digital gain (**EXP**) is shown in [Table 5](#). The DVGA’s compression of the incoming signal in the analog domain vs. the subsequent expansion in the digital domain is shown in [Figure 77](#).

The AGC may be forced to free run by setting AGC_HOLD_IC low. Writing an initial condition to AGC_IC_A|B and then setting AGC_HOLD_IC high will force the AGC to a fixed gain. The three MSBs of the value written to AGC_IC_A|B are inverted and output to drive the DVGA.

Allowing the AGC to free run should be appropriate for most applications. If the INH_EXP bit is not set, the DVGA gain word (**EXP**) is routed to the “FLOAT TO FIXED CONVERTER” in the DDCs prior to the programmable decimation filter. The **EXP** signals are delayed to account for the propagation delay of the DVGA interface and the ADC12DL080 ADC.

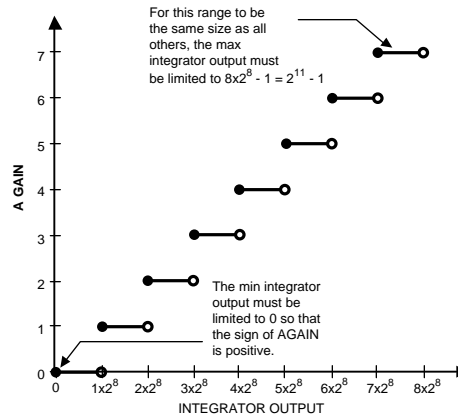

Figure 85. AGC integrator output limits

General Applications Information

OUTPUTS

Be very careful when driving a high capacitance bus. The more capacitance the output drivers must charge for each conversion, the more instantaneous digital current flows through V_{DR} and DRGND. These large charging current spikes can cause on-chip ground noise and couple into the analog circuitry, degrading dynamic performance. Adequate bypassing, limiting output capacitance and careful attention to the ground plane will reduce this problem.

To minimize noise due to output switching, minimize the load currents at the digital outputs. Only one driven input should be connected to each output pin. Additionally, inserting series resistors of about 100Ω at the digital outputs, close to the ADC pins, will isolate the outputs from trace and other circuit capacitances and limit the output currents, which could otherwise result in performance degradation. See [Figure 86](#).

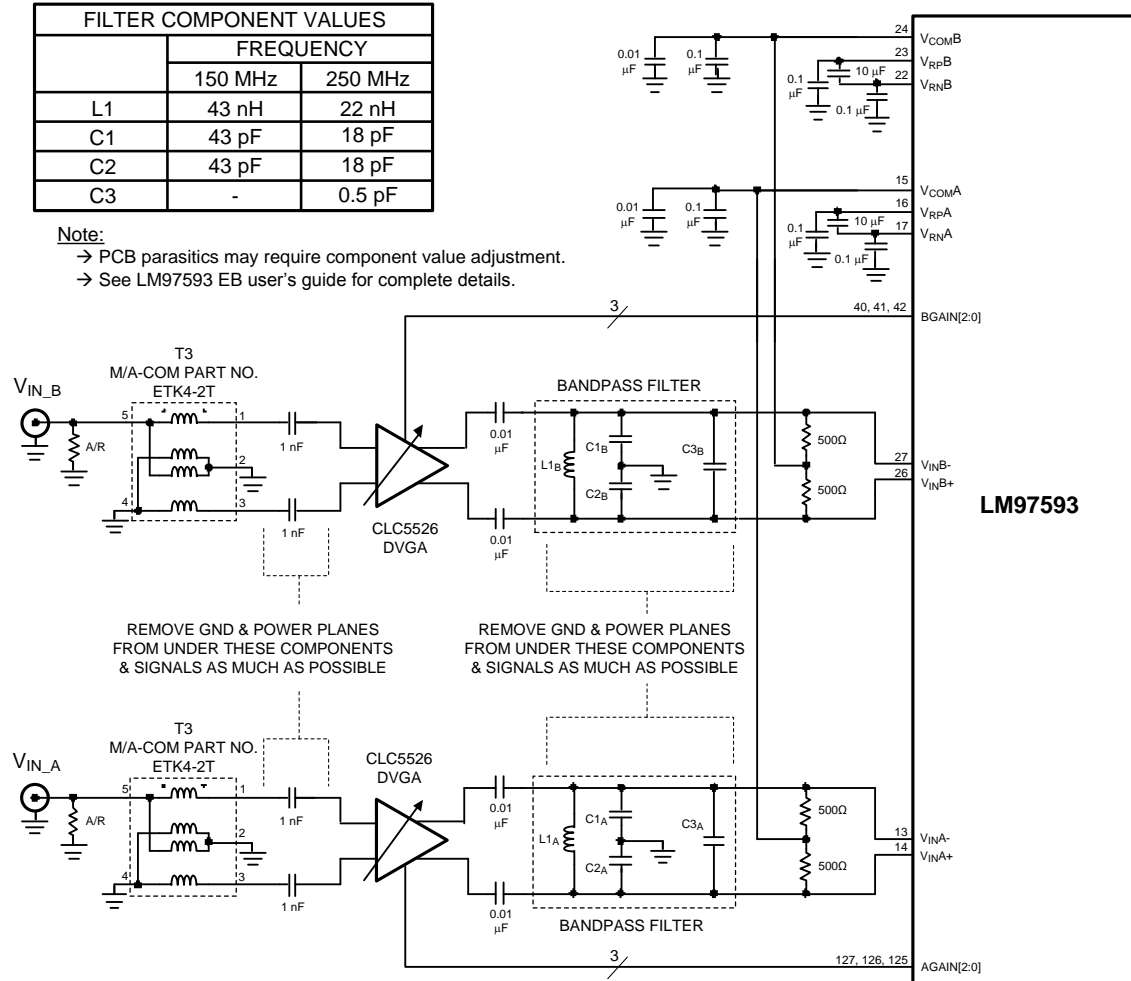

Figure 86. Application Circuit

POWER SUPPLY CONSIDERATIONS

The power supply pins should be bypassed with a 10 μF capacitor and with a 0.1 μF ceramic chip capacitor near each power pin. Leadless chip capacitors are preferred because they have low series inductance.

The LM97593 is sensitive to power supply noise. Accordingly, the noise on the analog supply pins should be kept below 100 mV_{P-P}.

No pin should ever have a voltage on it that is in excess of the supply voltages, not even on a transient basis. Be especially careful of this during power turn on and turn off.

The V_{DR} pin provides power for the output drivers and should be operated from a supply equivalent to V_D.

LAYOUT AND GROUNDING

A proper grounding and proper routing of all signals are essential to ensure accurate conversion. Maintaining separate analog and digital areas of the board, with the LM97593 between these areas, is required to achieve specified performance.

The ground return for the data outputs (DRGND) carries the ground current for the output drivers. The output current can exhibit high transients that could add noise to the conversion process. To prevent this from happening, the DRGND pins should NOT be connected to system ground in close proximity to any of the LM97593's other ground pins.

Capacitive coupling between the typically noisy digital circuitry and the sensitive analog circuitry can lead to poor performance. The solution is to keep the analog circuitry separated from the digital circuitry, and to keep the clock line as short as possible.

Digital circuits create substantial supply and ground current transients. The logic noise thus generated could have significant impact upon system noise performance. The best logic family to use in systems with A/D converters is one which employs non-saturating transistor designs, or has low noise characteristics, such as the 74LS, 74HC(T) and 74AC(T)Q families. The worst noise generators are logic families that create the largest supply current transients during clock or signal edges, like the 74F and the 74AC(T) families.

The effects of the noise generated from the LM97593 output switching can be minimized through the use of 100Ω resistors in series with each data output line. Locate these resistors as close to the LM97593 output pins as possible.

Since digital switching transients are composed largely of high frequency components, total ground plane copper weight will have little effect upon the logic-generated noise. This is because of the skin effect. Total surface area is more important than is total ground plane volume.

Generally, analog and digital lines should cross each other at 90° to avoid crosstalk. To maximize accuracy in high speed, high resolution systems, however, avoid crossing analog and digital lines altogether. It is important to keep clock lines as short as possible and isolated from ALL other lines, including other digital lines. Even the generally accepted 90° crossing should be avoided with the clock line as even a little coupling can cause problems at high frequencies. This is because other lines can introduce jitter into the clock line, which can lead to degradation of SNR. Also, the high speed clock can introduce noise into the analog chain.

Best performance at high frequencies and at high resolution is obtained with a straight signal path. That is, the signal path through all components should form a straight line wherever possible.

Be especially careful with the layout of inductors. Mutual inductance can change the characteristics of the circuit in which they are used. Inductors should *not* be placed side by side, even with just a small part of their bodies beside each other.

The analog input should be isolated from noisy signal traces to avoid coupling of spurious signals into the input. Any external component (e.g., a filter capacitor) connected between the converter's input pins and ground or to the reference input pin and ground should be connected to a very clean point in the ground plane.

All analog circuitry (input amplifiers, filters, reference components, etc.) should be placed in the analog area of the board. All digital circuitry and I/O lines should be placed in the digital area of the board. The LM97593 should be between these two areas. Furthermore, all components in the reference circuitry and the input signal chain that are connected to ground should be connected together with short traces and enter the ground plane at a single, quiet point. All ground connections should have a low inductance path to ground.

DYNAMIC PERFORMANCE

To achieve the best dynamic performance, the clock source driving the CLK input must be free of jitter. Isolate the ADC clock from any digital circuitry with buffers, as with the clock tree shown in [Figure 87](#). The gates used in the clock tree must be capable of operating at frequencies much higher than those used if added jitter is to be prevented.

Best performance will be obtained with a differential input drive, compared with a single-ended drive, as discussed in [Single-Ended Operation](#) and [Driving the Analog Inputs](#).

It is good practice to keep the clock line as short as possible and to keep it well away from any other signals. Other signals can introduce jitter into the clock signal, which can lead to reduced SNR performance, and the clock can introduce noise into other lines. Even lines with 90° crossings have capacitive coupling, so try to avoid even these 90° crossings of the clock line.

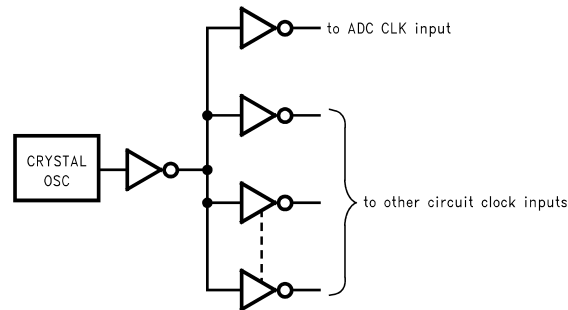

Figure 87. Isolating the ADC Clock from other Circuitry with a Clock Tree

Common Application Pitfalls

Driving the inputs (analog or digital) beyond the power supply rails. For proper operation, all inputs should not go more than 100 mV beyond the supply rails (more than 100 mV below the ground pins or 100 mV above the supply pins). Exceeding these limits on even a transient basis may cause faulty or erratic operation. It is not uncommon for high speed digital components (e.g., 74F and 74AC devices) to exhibit overshoot or undershoot that goes above the power supply or below ground. A resistor of about 47Ω to 100Ω in series with any offending digital input, close to the signal source, will eliminate the problem.

Do not allow input voltages to exceed the supply voltage, even on a transient basis. Not even during power up or power down.

Be careful not to overdrive the inputs of the LM97593 with a device that is powered from supplies outside the range of the LM97593 supply. Such practice may lead to conversion inaccuracies and even to device damage.

Attempting to drive a high capacitance digital data bus. The more capacitance the output drivers must charge for each conversion, the more instantaneous digital current flows through V_{DR} and DRGND. These large charging current spikes can couple into the analog circuitry, degrading dynamic performance. Adequate bypassing and maintaining separate analog and digital areas on the pc board will reduce this problem.

The digital data outputs should be buffered (with 74ACQ541, for example) if they will drive a large capacitive load. Dynamic performance can also be improved by adding series resistors at each digital output, close to the LM97593, which reduces the energy coupled back into the part's output pins by limiting the output current. A reasonable value for these resistors is 100Ω.

Using an inadequate amplifier to drive the analog input. As explained in [Signal Inputs](#), the capacitance seen at the input alternates between 8 pF and 7 pF, depending upon the phase of the clock. This dynamic load is more difficult to drive than is a fixed capacitance. If the amplifier exhibits overshoot, ringing, or any evidence of instability, even at a very low level, it will degrade performance. A small series resistor at each amplifier output and a capacitor at the analog inputs will improve performance.

Also, it is important that the signals at the two inputs have exactly the same amplitude and be exactly 180° out of phase with each other. Board layout, especially equality of the length of the two traces to the input pins, will affect the effective phase between these two signals. Remember that an operational amplifier operated in the non-inverting configuration will exhibit more time delay than will the same device operating in the inverting configuration.

Operating with the reference pins outside of the specified range. As mentioned in [Reference Pins](#), V_{REF} should be in the range of

$$0.8V \leq V_{REF} \leq 1.2V \quad (15)$$

Operating outside of these limits could lead to performance degradation.

Inadequate network on Reference Bypass pins ($V_{RP}A$, $V_{RN}A$, $V_{COM}A$, $V_{RP}B$, $V_{RN}B$ and $V_{COM}B$). As mentioned in [Reference Pins](#), these pins should be bypassed with 0.1 μF capacitors to ground at $V_{RM}A$ and $V_{RM}B$ and with a 10 μF between pins $V_{RP}A$ and $V_{RN}A$ and between $V_{RP}B$ and $V_{RN}B$ for best performance.

Using a clock source with excessive jitter, using excessively long clock signal trace, or having other signals coupled to the clock signal trace. This will cause the sampling interval to vary, causing excessive output noise and a reduction in SNR and SINAD performance.

Evaluation Hardware

Evaluation boards are available to facilitate designs based on the LM97593:

LM97593EB

The LM97593 evaluation board provides a complete narrowband receiver from IF to digital symbols.

SOFTWARE

Control panel software for the LM97593 supports complete device configuration on both evaluation boards.

Integrated capture software manages the capture of data and its storage in a file on a PC.

Matlab script files support data analysis: FFT, DNL, and INL plotting.

This software and additional application information is available on the *Basestation CDROM*.

REVISION HISTORY

Changes from Revision A (April 2013) to Revision B	Page
• Changed layout of National Data Sheet to TI format	57

PACKAGING INFORMATION

Orderable Device	Status (1)	Package Type	Package Drawing	Pins	Package Qty	Eco Plan (2)	Lead/Ball Finish (6)	MSL Peak Temp (3)	Op Temp (°C)	Device Marking (4/5)	Samples
LM97593VH/NOPB	ACTIVE	QFP	NND	128	66	Green (RoHS & no Sb/Br)	CU SN	Level-3-245C-168 HR	-40 to 85	LM97593VH	Samples

(1) The marketing status values are defined as follows:

ACTIVE: Product device recommended for new designs.

LIFEBUY: TI has announced that the device will be discontinued, and a lifetime-buy period is in effect.

NRND: Not recommended for new designs. Device is in production to support existing customers, but TI does not recommend using this part in a new design.

PREVIEW: Device has been announced but is not in production. Samples may or may not be available.

OBSELETE: TI has discontinued the production of the device.

(2) Eco Plan - The planned eco-friendly classification: Pb-Free (RoHS), Pb-Free (RoHS Exempt), or Green (RoHS & no Sb/Br) - please check <http://www.ti.com/productcontent> for the latest availability information and additional product content details.

TBD: The Pb-Free/Green conversion plan has not been defined.

Pb-Free (RoHS): TI's terms "Lead-Free" or "Pb-Free" mean semiconductor products that are compatible with the current RoHS requirements for all 6 substances, including the requirement that lead not exceed 0.1% by weight in homogeneous materials. Where designed to be soldered at high temperatures, TI Pb-Free products are suitable for use in specified lead-free processes.

Pb-Free (RoHS Exempt): This component has a RoHS exemption for either 1) lead-based flip-chip solder bumps used between the die and package, or 2) lead-based die adhesive used between the die and leadframe. The component is otherwise considered Pb-Free (RoHS compatible) as defined above.

Green (RoHS & no Sb/Br): TI defines "Green" to mean Pb-Free (RoHS compatible), and free of Bromine (Br) and Antimony (Sb) based flame retardants (Br or Sb do not exceed 0.1% by weight in homogeneous material)

(3) MSL, Peak Temp. - The Moisture Sensitivity Level rating according to the JEDEC industry standard classifications, and peak solder temperature.

(4) There may be additional marking, which relates to the logo, the lot trace code information, or the environmental category on the device.

(5) Multiple Device Markings will be inside parentheses. Only one Device Marking contained in parentheses and separated by a "~" will appear on a device. If a line is indented then it is a continuation of the previous line and the two combined represent the entire Device Marking for that device.

(6) Lead/Ball Finish - Orderable Devices may have multiple material finish options. Finish options are separated by a vertical ruled line. Lead/Ball Finish values may wrap to two lines if the finish value exceeds the maximum column width.

Important Information and Disclaimer: The information provided on this page represents TI's knowledge and belief as of the date that it is provided. TI bases its knowledge and belief on information provided by third parties, and makes no representation or warranty as to the accuracy of such information. Efforts are underway to better integrate information from third parties. TI has taken and continues to take reasonable steps to provide representative and accurate information but may not have conducted destructive testing or chemical analysis on incoming materials and chemicals. TI and TI suppliers consider certain information to be proprietary, and thus CAS numbers and other limited information may not be available for release.

In no event shall TI's liability arising out of such information exceed the total purchase price of the TI part(s) at issue in this document sold by TI to Customer on an annual basis.

NND0128A

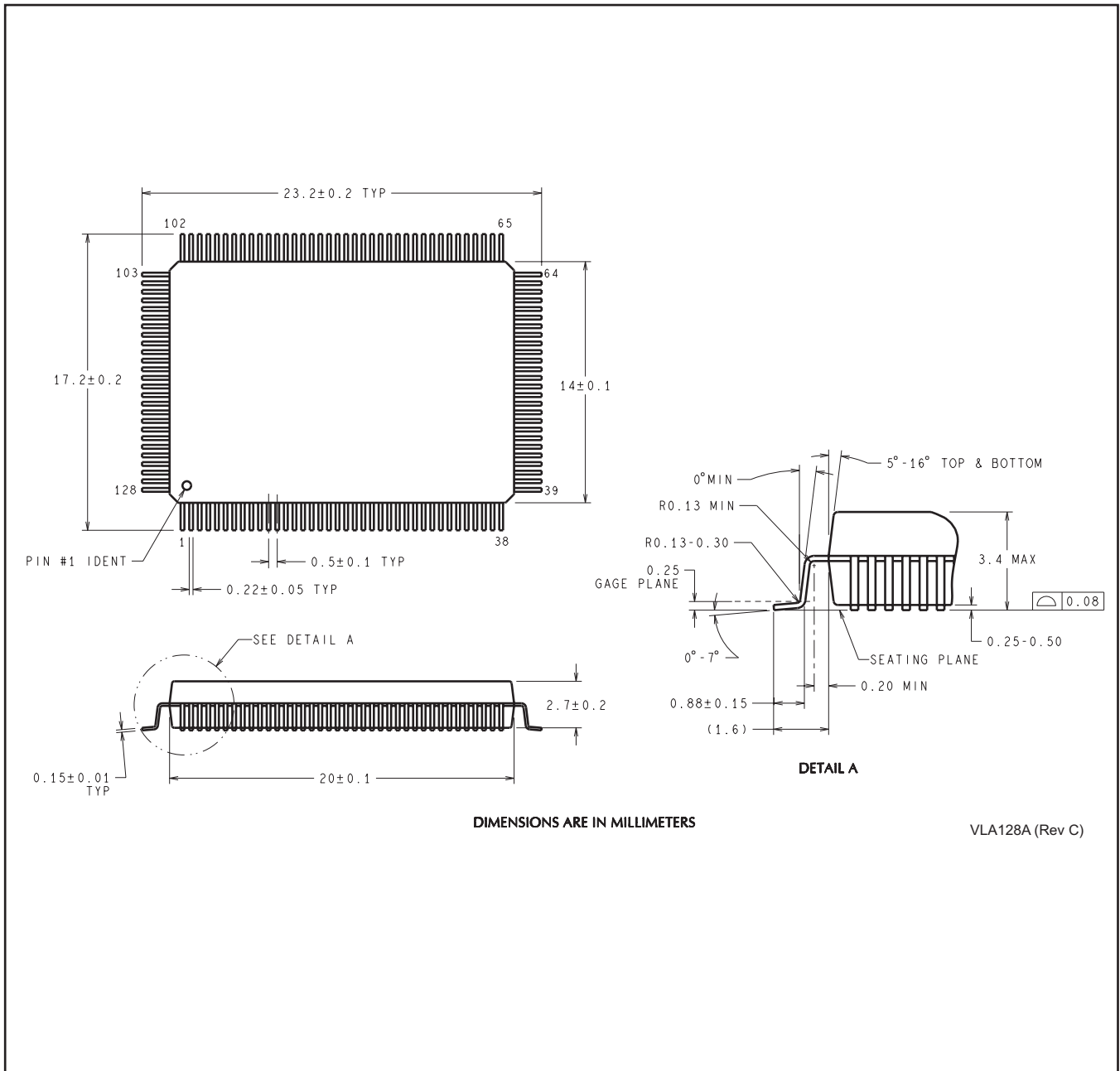

IMPORTANT NOTICE

Texas Instruments Incorporated and its subsidiaries (TI) reserve the right to make corrections, enhancements, improvements and other changes to its semiconductor products and services per JESD46, latest issue, and to discontinue any product or service per JESD48, latest issue. Buyers should obtain the latest relevant information before placing orders and should verify that such information is current and complete. All semiconductor products (also referred to herein as "components") are sold subject to TI's terms and conditions of sale supplied at the time of order acknowledgment.

TI warrants performance of its components to the specifications applicable at the time of sale, in accordance with the warranty in TI's terms and conditions of sale of semiconductor products. Testing and other quality control techniques are used to the extent TI deems necessary to support this warranty. Except where mandated by applicable law, testing of all parameters of each component is not necessarily performed.

TI assumes no liability for applications assistance or the design of Buyers' products. Buyers are responsible for their products and applications using TI components. To minimize the risks associated with Buyers' products and applications, Buyers should provide adequate design and operating safeguards.

TI does not warrant or represent that any license, either express or implied, is granted under any patent right, copyright, mask work right, or other intellectual property right relating to any combination, machine, or process in which TI components or services are used. Information published by TI regarding third-party products or services does not constitute a license to use such products or services or a warranty or endorsement thereof. Use of such information may require a license from a third party under the patents or other intellectual property of the third party, or a license from TI under the patents or other intellectual property of TI.

Reproduction of significant portions of TI information in TI data books or data sheets is permissible only if reproduction is without alteration and is accompanied by all associated warranties, conditions, limitations, and notices. TI is not responsible or liable for such altered documentation. Information of third parties may be subject to additional restrictions.

Resale of TI components or services with statements different from or beyond the parameters stated by TI for that component or service voids all express and any implied warranties for the associated TI component or service and is an unfair and deceptive business practice. TI is not responsible or liable for any such statements.

Buyer acknowledges and agrees that it is solely responsible for compliance with all legal, regulatory and safety-related requirements concerning its products, and any use of TI components in its applications, notwithstanding any applications-related information or support that may be provided by TI. Buyer represents and agrees that it has all the necessary expertise to create and implement safeguards which anticipate dangerous consequences of failures, monitor failures and their consequences, lessen the likelihood of failures that might cause harm and take appropriate remedial actions. Buyer will fully indemnify TI and its representatives against any damages arising out of the use of any TI components in safety-critical applications.

In some cases, TI components may be promoted specifically to facilitate safety-related applications. With such components, TI's goal is to help enable customers to design and create their own end-product solutions that meet applicable functional safety standards and requirements. Nonetheless, such components are subject to these terms.

No TI components are authorized for use in FDA Class III (or similar life-critical medical equipment) unless authorized officers of the parties have executed a special agreement specifically governing such use.

Only those TI components which TI has specifically designated as military grade or "enhanced plastic" are designed and intended for use in military/aerospace applications or environments. Buyer acknowledges and agrees that any military or aerospace use of TI components which have **not** been so designated is solely at the Buyer's risk, and that Buyer is solely responsible for compliance with all legal and regulatory requirements in connection with such use.

TI has specifically designated certain components as meeting ISO/TS16949 requirements, mainly for automotive use. In any case of use of non-designated products, TI will not be responsible for any failure to meet ISO/TS16949.

Products

Audio	www.ti.com/audio
Amplifiers	amplifier.ti.com
Data Converters	dataconverter.ti.com
DLP® Products	www.dlp.com
DSP	dsp.ti.com
Clocks and Timers	www.ti.com/clocks
Interface	interface.ti.com
Logic	logic.ti.com
Power Mgmt	power.ti.com
Microcontrollers	microcontroller.ti.com
RFID	www.ti-rfid.com
OMAP Applications Processors	www.ti.com/omap
Wireless Connectivity	www.ti.com/wirelessconnectivity

Applications

Automotive and Transportation	www.ti.com/automotive
Communications and Telecom	www.ti.com/communications
Computers and Peripherals	www.ti.com/computers
Consumer Electronics	www.ti.com/consumer-apps
Energy and Lighting	www.ti.com/energy
Industrial	www.ti.com/industrial
Medical	www.ti.com/medical
Security	www.ti.com/security
Space, Avionics and Defense	www.ti.com/space-avionics-defense
Video and Imaging	www.ti.com/video

TI E2E Community

e2e.ti.com

Looking for pricing, stock, or lifecycle information?

Click below to explore more details on WIN SOURCE:

 [View LM97593VH/NOPB on WIN SOURCE](#)

 [Texas Instruments](#) Information

Optimize Your Supply Chain with WIN SOURCE Solutions

-  Global Sourcing Solution
-  Obsolete Management
-  Cost Control Management
-  Shortage Management
-  Alternative Solution
-  Excess Inventory Management