



**THE DATASHEET OF
LMV931Q1MFX/NOPB**



LMV93x-N-Q1 Automotive Single, Dual, Quad 1.8-V, RRIO Operational Amplifiers

1 Features

- Qualified for Automotive Applications
- AEC-Q100 Qualified With the Following Results:
 - Device Temperature Grade 1: –40°C to +125°C Ambient Operating Temperature
 - Device HBM ESD Classification Level 02
 - Device CDM ESD Classification Level C5
- Typical 1.8-V Supply Values; Unless Otherwise Noted
- Specified at 1.8 V, 2.7 V, and 5 V
- Output Swing
 - With 600-Ω Load 80 mV from Rail
 - With 2-kΩ Load 30 mV from Rail
- V_{CM} 200 mV Beyond Rails
- Supply Current (per Channel) 100 μA
- Gain Bandwidth Product 1.4 MHz
- Maximum V_{OS} 4 mV
- Ultra Tiny Packages
- Temperature Range –40°C to +125°C
- Create a Custom Design Using the LMV93x-N-Q1 With the [WEBENCH® Power Designer](#)

2 Applications

- Engine Control Units (ECU)
- Body Control Modules (BCM)
- Battery Management Systems (BMS)
- Ultrasonic Ranging and LIDAR
- Occupant Detection
- Infotainment Systems

High-Side Current Sense Amplifier

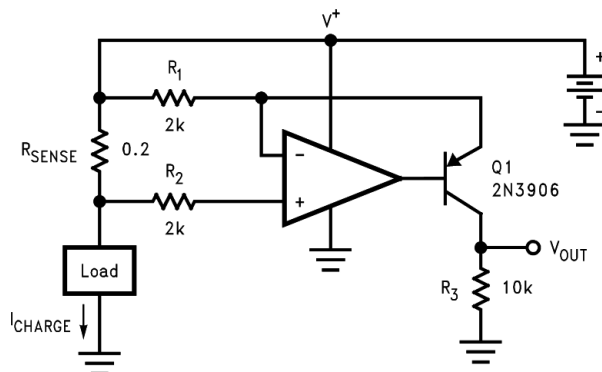

$$V_{OUT} = \frac{R_{SENSE} \cdot R_3}{R_1} \cdot I_{Charge} = 1.0 \cdot I_{Charge}$$

3 Description

The LMV93x-N-Q1 family (LMV931-N-Q1 single, LMV932-N-Q1 dual and LMV934-N-Q1 quad) are low-voltage, low-power operational amplifiers with AEC-Q100 Grade 1 qualification for automotive applications. The LMV93x-N-Q1 family operates from 1.8-V to 5.5-V supply voltages and have rail-to-rail input and output. The input common-mode voltage extends 200 mV beyond the supplies which enables user enhanced functionality beyond the supply voltage range. The output can swing rail-to-rail unloaded and within 105 mV from the rail with 600-Ω load at 1.8-V supply. The LMV93x-N-Q1 devices are optimized to work at 1.8 V, which make them ideal for portable two-cell, battery-powered systems and single-cell Li-Ion systems.

LMV93x-N-Q1 devices exhibit an excellent speed-power ratio, achieving 1.4-MHz gain bandwidth product at 1.8-V supply voltage with very low supply current. The LMV93x-N-Q1 devices can drive a 600-Ω load and up to 1000-pF capacitive load with minimal ringing. These devices also have a high DC gain of 101 dB, making them suitable for low-frequency applications.

The single LMV93x-N-Q1 is offered in space-saving 5-pin SC-70 and SOT-23 packages. The dual LMV932-N-Q1 is in a 8-pin SOIC package and the quad LMV934-N-Q1 is in a 14-pin TSSOP package. These small packages are ideal solutions for area constrained PC boards in automotive applications.

Device Information⁽¹⁾

| PART NUMBER | PACKAGE | BODY SIZE (NOM) |
|-------------|------------|-------------------|
| LMV931-N-Q1 | SOT-23 (5) | 2.90 mm x 1.60 mm |
| | SC-70 (5) | 2.00 mm x 1.25 mm |
| LMV932-N-Q1 | SOIC (8) | 4.90 mm x 3.91 mm |
| LMV934-N-Q1 | TSSOP (14) | 5.00 mm x 4.40 mm |

(1) For all available packages, see the orderable addendum at the end of the data sheet.



Table of Contents

| | | | |
|--|-----------|--|-----------|
| 1 Features | 1 | 7.3 Feature Description | 16 |
| 2 Applications | 1 | 7.4 Device Functional Modes | 16 |
| 3 Description | 1 | 8 Application and Implementation | 19 |
| 4 Revision History | 2 | 8.1 Application Information | 19 |
| 5 Pin Configuration and Functions | 3 | 8.2 Typical Applications | 19 |
| 6 Specifications | 4 | 8.3 Dos and Don'ts | 23 |
| 6.1 Absolute Maximum Ratings | 4 | 9 Power Supply Recommendations | 23 |
| 6.2 ESD Ratings | 4 | 10 Layout | 24 |
| 6.3 Recommended Operating Ratings | 4 | 10.1 Layout Guidelines | 24 |
| 6.4 Thermal Information | 4 | 10.2 Layout Example | 24 |
| 6.5 DC Electrical Characteristics 1.8 V | 5 | 11 Device and Documentation Support | 25 |
| 6.6 AC Electrical Characteristics 1.8 V | 6 | 11.1 Device Support | 25 |
| 6.7 DC Electrical Characteristics 2.7 V | 6 | 11.2 Documentation Support | 25 |
| 6.8 AC Electrical Characteristics 2.7 V | 8 | 11.3 Related Links | 25 |
| 6.9 Electrical Characteristics 5 V DC | 9 | 11.4 Receiving Notification of Documentation Updates | 25 |
| 6.10 AC Electrical Characteristics 5 V | 10 | 11.5 Community Resources | 26 |
| 6.11 Typical Characteristics | 11 | 11.6 Trademarks | 26 |
| 7 Detailed Description | 16 | 11.7 Electrostatic Discharge Caution | 26 |
| 7.1 Overview | 16 | 11.8 Glossary | 26 |
| 7.2 Functional Block Diagram | 16 | 12 Mechanical, Packaging, and Orderable Information | 26 |

4 Revision History

NOTE: Page numbers for previous revisions may differ from page numbers in the current version.

| DATE | REVISION | NOTES |
|----------|----------|------------------|
| May 2017 | * | Initial release. |

5 Pin Configuration and Functions

DBV and DCK Packages
5-Pin SC-70 and SOT-23
LMV931-N-Q1 Top View

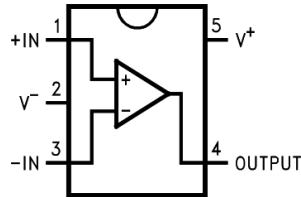

Pin Functions: LMV931-N-Q1

| PIN | | I/O | DESCRIPTION |
|------|-------------|-----|--------------------|
| NAME | LMV931-N-Q1 | | |
| +IN | 1 | I | Noninverting Input |
| -IN | 3 | I | Inverting Input |
| OUT | 4 | O | Output |
| V- | 2 | P | Negative Supply |
| V+ | 5 | P | Positive Supply |

D Package
8-Pin SOIC
LMV932-N-Q1 Top View

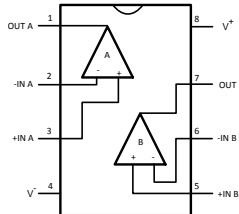

DGK Package
14-Pin TSSOP
LMV934-N-Q1 Top View

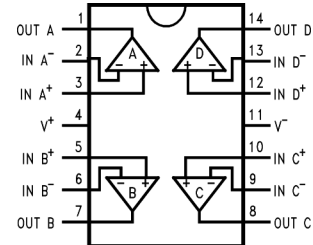

Pin Functions: LMV932-N-Q1 and LMV934-N-Q1

| PIN | | | I/O | DESCRIPTION |
|-------|-------------|-------------|-----|---------------------------------|
| NAME | LMV932-N-Q1 | LMV934-N-Q1 | | |
| +IN A | 3 | 3 | I | Noninverting input, channel A |
| +IN B | 5 | 5 | I | Noninverting input, channel B |
| +IN C | — | 10 | I | Noninverting input, channel C |
| +IN D | — | 12 | I | Noninverting input, channel D |
| -IN A | 2 | 2 | I | Inverting input, channel A |
| -IN B | 6 | 6 | I | Inverting input, channel B |
| -IN C | — | 9 | I | Inverting input, channel C |
| -IN D | — | 13 | I | Inverting input, channel D |
| OUT A | 1 | 1 | O | Output, channel A |
| OUT B | 7 | 7 | O | Output, channel B |
| OUT C | — | 8 | O | Output, channel C |
| OUT D | — | 14 | O | Output, channel D |
| V+ | 8 | 4 | P | Positive (highest) power supply |
| V- | 4 | 11 | P | Negative (lowest) power supply |

6 Specifications

6.1 Absolute Maximum Ratings

See ⁽¹⁾⁽²⁾.

| | MIN | MAX | UNIT |
|-------------------------------------|---------------|---------------|------|
| Supply voltage ($V^+ - V^-$) | -0.3 | 6 | V |
| Differential input voltage | V^- | V^+ | |
| Voltage at input/output pins | $(V^-) - 0.3$ | $(V^+) + 0.3$ | |
| Junction temperature ⁽³⁾ | -40 | 150 | °C |
| Storage temperature, T_{stg} | -65 | 150 | °C |

- (1) *Absolute Maximum Ratings* indicate limits beyond which damage to the device may occur. *Recommended Operating Conditions* indicate conditions for which the device is intended to be functional, but specific performance is not specified. For specifications and the test conditions, see the *Electrical Characteristics*.
- (2) If Military/Aerospace specified devices are required, contact the TI Sales Office/Distributors for availability and specifications.
- (3) The maximum power dissipation is a function of $T_{J(max)}$, $R_{\theta JA}$, and T_A . The maximum allowable power dissipation at any ambient temperature is $P_D = (T_{J(max)} - T_A) / R_{\theta JA}$. All numbers apply for packages soldered directly into a PC board.

6.2 ESD Ratings

| | | VALUE | UNIT |
|-------------------------------------|---|-------|------|
| $V_{(ESD)}$ Electrostatic discharge | Human-body model (HBM), per AEC Q100-002 ⁽¹⁾ | ±2000 | V |
| | Charged-device model (CDM), per AEC Q100-011 | ±750 | |

- (1) AEC Q100-002 indicates that HBM stressing shall be in accordance with the ANSI/ESDA/JEDEC JS-001 specification.

6.3 Recommended Operating Ratings

See⁽¹⁾.

| | MIN | MAX | UNIT |
|--------------------------------|-----|-----|------|
| Supply voltage ($V^+ - V^-$) | 1.8 | 5.5 | V |
| Ambient temperature | -40 | 125 | °C |

- (1) *Absolute Maximum Ratings* indicate limits beyond which damage to the device may occur. *Recommended Operating Conditions* indicate conditions for which the device is intended to be functional, but specific performance is not specified. For specifications and the test conditions, see the *Electrical Characteristics*.

6.4 Thermal Information

| THERMAL METRIC ⁽¹⁾ | LMV931-N-Q1 | | LMV932-N-Q1 | LMV934-N-Q1 | UNIT |
|---|--------------|------------|-------------|-------------|------|
| | DBV (SOT-23) | DCK (SC70) | D (SOIC) | PW (TSSOP) | |
| | 5 PINS | 5 PINS | 8 PINS | 14 PINS | |
| $R_{\theta JA}$ Junction-to-ambient thermal resistance | 197.2 | 285.9 | 125.9 | 124.8 | °C/W |
| $R_{\theta JC(top)}$ Junction-to-case (top) thermal resistance | 156.7 | 115.9 | 70.2 | 51.4 | °C/W |
| $R_{\theta JB}$ Junction-to-board thermal resistance | 55.6 | 63.7 | 66.5 | 67.2 | °C/W |
| ψ_{JT} Junction-to-top characterization parameter | 41.4 | 4.5 | 19.8 | 6.6 | °C/W |
| ψ_{JB} Junction-to-board characterization parameter | 55 | 62.9 | 65.9 | 66.6 | °C/W |
| $R_{\theta JC(bot)}$ Junction-to-case (bottom) thermal resistance | — | — | — | — | °C/W |

- (1) For more information about traditional and new thermal metrics, see the *Semiconductor and IC Package Thermal Metrics* application report.

6.5 DC Electrical Characteristics 1.8 V

Unless otherwise specified, all limits specified for $T_J = 25^\circ\text{C}$. $V^+ = 1.8\text{ V}$, $V^- = 0\text{ V}$, $V_{CM} = V^+/2$, $V_O = V^+/2$ and $R_L > 1\text{ M}\Omega$.

| PARAMETER | | TEST CONDITIONS | | MIN | TYP ⁽¹⁾ | MAX | UNIT |
|------------|---|---|---------------|-------------|--------------------|-------------|------------------------------|
| V_{OS} | Input Offset Voltage | LMV931-N-Q1 (Single) | 25°C | | 1 | 4 | mV |
| | | | Full Range | | | 6 | |
| | | LMV932-N-Q1 (Dual), LMV934-N-Q1 (Quad) | 25°C | | 1 | 5.5 | mV |
| | | | Full Range | | | 7.5 | |
| TCV_{OS} | Input Offset Voltage Average Drift | | Full Range | | 5.5 | | $\mu\text{V}/^\circ\text{C}$ |
| I_B | Input Bias Current | | 25°C | | 15 | 35 | nA |
| | | | Full Range | | | 50 | |
| I_{OS} | Input Offset Current | | 25°C | | 13 | 25 | nA |
| | | | Full Range | | | 40 | |
| I_S | Supply Current (per channel) | | 25°C | | 103 | 185 | μA |
| | | | Full Range | | | 205 | |
| CMRR | Common-Mode Rejection Ratio | LMV931-N-Q1, $0 \leq V_{CM} \leq 0.6\text{ V}$ $1.4\text{ V} \leq V_{CM} \leq 1.8\text{ V}$ ⁽²⁾ | 25°C | 60 | 78 | dB | |
| | | | Full Range | 55 | | | |
| | | LMV932-N-Q1 and LMV934-N-Q1 $0 \leq V_{CM} \leq 0.6\text{ V}$ $1.4\text{ V} \leq V_{CM} \leq 1.8\text{ V}$ ⁽²⁾ | 25°C | 55 | 76 | dB | |
| | | | Full Range | 50 | | | |
| PSRR | Power Supply Rejection Ratio | $1.8\text{ V} \leq V^+ \leq 5\text{ V}$ | 25°C | 75 | 100 | dB | |
| | | | Full Range | 70 | | | |
| CMVR | Input Common-Mode Voltage Range | For CMRR Range $\geq 50\text{ dB}$ | 25°C | $V^- - 0.2$ | -0.2 | $V^+ + 0.2$ | V |
| | | | -40°C to 85°C | V^- | to | V^+ | |
| | | | 125°C | $V^- + 0.2$ | 2.1 | $V^+ - 0.2$ | |
| A_V | Large Signal Voltage Gain LMV931-N-Q1 (Single) | $R_L = 600\ \Omega$ to 0.9 V , $V_O = 0.2\text{ V}$ to 1.6 V , $V_{CM} = 0.5\text{ V}$ | 25°C | 77 | 101 | dB | |
| | | | Full Range | 73 | | | |
| | | $R_L = 2\text{ k}\Omega$ to 0.9 V , $V_O = 0.2\text{ V}$ to 1.6 V , $V_{CM} = 0.5\text{ V}$ | 25°C | 80 | 105 | dB | |
| | | | Full Range | 75 | | | |
| | Large Signal Voltage Gain LMV932-N-Q1 (Dual) LMV934-N-Q1 (Quad) | $R_L = 600\ \Omega$ to 0.9 V , $V_O = 0.2\text{ V}$ to 1.6 V , $V_{CM} = 0.5\text{ V}$ | 25°C | 75 | 90 | dB | |
| | | | Full Range | 72 | | | |
| | | $R_L = 2\text{ k}\Omega$ to 0.9 V , $V_O = 0.2\text{ V}$ to 1.6 V , $V_{CM} = 0.5\text{ V}$ | 25°C | 78 | 100 | dB | |
| | | | Full Range | 75 | | | |
| V_O | Output Swing LMV931-N-Q1 (Single) | $R_L = 600\ \Omega$ to 0.9 V $V_{IN} = \pm 100\text{ mV}$ | 25°C | 1.65 | 1.72 | V | |
| | | | Full Range | 1.63 | 0.105 | | |
| | | $R_L = 2\text{ k}\Omega$ to 0.9 V $V_{IN} = \pm 100\text{ mV}$ | 25°C | 1.75 | 1.77 | V | |
| | | | Full Range | 1.74 | 0.04 | | |

(1) Typical values represent the most likely parametric norm as determined at the time of characterization. Actual typical values may vary over time and will also depend on the application and configuration.

(2) For specified temperature ranges, see the CMVR parameter in [DC Electrical Characteristics 1.8 V](#) for the input common-mode voltage specifications.

DC Electrical Characteristics 1.8 V (continued)

Unless otherwise specified, all limits specified for $T_J = 25^\circ\text{C}$. $V^+ = 1.8\text{ V}$, $V^- = 0\text{ V}$, $V_{CM} = V^+/2$, $V_O = V^+/2$ and $R_L > 1\text{ M}\Omega$.

| PARAMETER | | TEST CONDITIONS | | MIN | TYP ⁽¹⁾ | MAX | UNIT |
|-----------|--|--|--------------------|------|--------------------|-------|------|
| V_O | Output Swing LMV932-N-Q1 (Dual) LMV934-N-Q1 (Quad) | $R_L = 600\ \Omega$ to 0.9 V $V_{IN} = \pm 100\text{ mV}$ | 25°C | 1.65 | 1.72 | | V |
| | | | Full Range | | 0.077 | 0.105 | |
| | | $R_L = 2\text{ k}\Omega$ to 0.9 V $V_{IN} = \pm 100\text{ mV}$ | 25°C | 1.75 | 1.77 | | V |
| | | | Full Range | | 0.024 | 0.055 | |
| I_O | Output Short Circuit Current ⁽³⁾ | Sourcing, $V_O = 0\text{ V}$ $V_{IN} = 100\text{ mV}$ | 25°C | 4 | 8 | | mA |
| | | | Full Range | | 3.3 | | |
| | | Sinking, $V_O = 1.8\text{ V}$ $V_{IN} = -100\text{ mV}$ | 25°C | 7 | 9 | | mA |
| | | | Full Range | | 5 | | |

(3) Applies to both single-supply and split-supply operation. Continuous short circuit operation at elevated ambient temperature can result in exceeding the maximum allowed junction temperature of 150°C . Output currents in excess of 45 mA over long term may adversely affect reliability.

6.6 AC Electrical Characteristics 1.8 V

Unless otherwise specified, all limits specified for $T_J = 25^\circ\text{C}$. $V^+ = 1.8\text{ V}$, $V^- = 0\text{ V}$, $V_{CM} = V^+/2$, $V_O = V^+/2$ and $R_L > 1\text{ M}\Omega$.

| PARAMETER | | TEST CONDITIONS | | MIN | TYP ⁽¹⁾ | MAX | UNIT |
|-----------|----------------------------------|---|--|-----|--------------------|-----|------------------------------|
| SR | Slew Rate | See ⁽²⁾ . | | | 0.35 | | $\text{V}/\mu\text{s}$ |
| GBW | Gain-Bandwidth Product | | | | 1.4 | | MHz |
| Φ_m | Phase Margin | | | | 67 | | deg |
| G_m | Gain Margin | | | | 7 | | dB |
| e_n | Input-Referred Voltage Noise | $f = 10\text{ kHz}$, $V_{CM} = 0.5\text{ V}$ | | | 60 | | $\text{nV}/\sqrt{\text{Hz}}$ |
| i_n | Input-Referred Current Noise | $f = 10\text{ kHz}$ | | | 0.08 | | $\text{pA}/\sqrt{\text{Hz}}$ |
| THD | Total Harmonic Distortion | $f = 1\text{ kHz}$, $A_V = +1$ $R_L = 600\ \Omega$, $V_{IN} = 1\text{ V}_{PP}$ | | | 0.023% | | |
| | Amplifier-to-Amplifier Isolation | See ⁽³⁾ | | | 123 | | dB |

- (1) Typical values represent the most likely parametric norm as determined at the time of characterization. Actual typical values may vary over time and will also depend on the application and configuration.
 (2) Connected as voltage follower with input step from V^- to V^+ . Number specified is the slower of the positive and negative slew rates.
 (3) Input referred, $R_L = 100\text{ k}\Omega$ connected to $V^+/2$. Each amplifier excited in turn with 1 kHz to produce $V_O = 3\text{ V}_{PP}$ (For Supply Voltages $< 3\text{ V}$, $V_O = V^+$).

6.7 DC Electrical Characteristics 2.7 V

Unless otherwise specified, all limits specified for $T_J = 25^\circ\text{C}$. $V^+ = 2.7\text{ V}$, $V^- = 0\text{ V}$, $V_{CM} = V^+/2$, $V_O = V^+/2$ and $R_L > 1\text{ M}\Omega$.

| PARAMETER | | TEST CONDITIONS | | MIN | TYP ⁽¹⁾ | MAX | UNIT |
|------------|------------------------------------|--|--------------------|-----|--------------------|-----|------------------------------|
| V_{OS} | Input Offset Voltage | LMV931-N-Q1 (Single) | 25°C | | 1 | 4 | mV |
| | | | Full Range | | | 6 | |
| | | LMV932-N-Q1 (Dual) LMV934-N-Q1 (Quad) | 25°C | | 1 | 5.5 | mV |
| | | | Full Range | | | 7.5 | |
| TCV_{OS} | Input Offset Voltage Average Drift | Full Range | | | 5.5 | | $\mu\text{V}/^\circ\text{C}$ |
| I_B | Input Bias Current | 25°C | | | 15 | 35 | nA |
| | | Full Range | | | | 50 | |
| I_{OS} | Input Offset Current | 25°C | | | 8 | 25 | nA |
| | | Full Range | | | | 40 | |
| I_S | Supply Current (per channel) | 25°C | | | 105 | 190 | μA |
| | | Full Range | | | | 210 | |

(1) Typical values represent the most likely parametric norm as determined at the time of characterization. Actual typical values may vary over time and will also depend on the application and configuration.

DC Electrical Characteristics 2.7 V (continued)

Unless otherwise specified, all limits specified for $T_J = 25^\circ\text{C}$, $V^+ = 2.7\text{ V}$, $V^- = 0\text{ V}$, $V_{CM} = V^+/2$, $V_O = V^+/2$ and $R_L > 1\text{ M}\Omega$.

| PARAMETER | | TEST CONDITIONS | | MIN | TYP ⁽¹⁾ | MAX | UNIT | |
|---|---|--|--|--|-----------------------|----------------------------|-------|----|
| CMRR | Common-Mode Rejection Ratio | LMV931-N-Q1, $0 \leq V_{CM} \leq 1.5\text{ V}$ $2.3\text{ V} \leq V_{CM} \leq 2.7\text{ V}^{(2)}$ | 25°C | 60 | 81 | dB | | |
| | | | Full Range | 55 | | | | |
| | | LMV932-N-Q1 and LMV934-N-Q1 $0 \leq V_{CM} \leq 1.5\text{ V}$ $2.3\text{ V} \leq V_{CM} \leq 2.7\text{ V}^{(2)}$ | 25°C | 55 | 80 | dB | | |
| | | | Full Range | 50 | | | | |
| | | $-0.2\text{ V} \leq V_{CM} \leq 0\text{ V}$ $2.7\text{ V} \leq V_{CM} \leq 2.9\text{ V}$ | 25°C | 50 | 74 | dB | | |
| PSRR | Power Supply Rejection Ratio | $1.8\text{ V} \leq V^+ \leq 5\text{ V}$ $V_{CM} = 0.5\text{ V}$ | 25°C | 75 | 100 | dB | | |
| | | | Full Range | 70 | | | | |
| V_{CM} | Input Common-Mode Voltage Range | For CMRR Range $\geq 50\text{ dB}$ | 25°C | $V^- - 0.2$ | -0.2 to 3.0 | $V^+ + 0.2$ to V^+ | V | |
| | | | -40°C to 85°C | V^- | | | | |
| | | | 125°C | $V^- + 0.2$ | | $V^+ - 0.2$ | | |
| A_V | Large Signal Voltage Gain LMV931-N-Q1 (Single) | $R_L = 600\ \Omega$ to 1.35 V , $V_O = 0.2\text{ V}$ to 2.5 V | 25°C | 87 | 104 | dB | | |
| | | | Full Range | 86 | | | | |
| | | $R_L = 2\text{ k}\Omega$ to 1.35 V , $V_O = 0.2\text{ V}$ to 2.5 V | 25°C | 92 | 110 | dB | | |
| | | | Full Range | 91 | | | | |
| | Large Signal Voltage Gain LMV932-N-Q1 (Dual) LMV934-N-Q1 (Quad) | $R_L = 600\ \Omega$ to 1.35 V , $V_O = 0.2\text{ V}$ to 2.5 V | 25°C | 78 | 90 | dB | | |
| | | | Full Range | 75 | | | | |
| | | $R_L = 2\text{ k}\Omega$ to 1.35 V , $V_O = 0.2\text{ V}$ to 2.5 V | 25°C | 81 | 100 | dB | | |
| | | | Full Range | 78 | | | | |
| V_O | Output Swing LMV931-N-Q1 (Single) | $R_L = 600\ \Omega$ to 1.35 V $V_{IN} = \pm 100\text{ mV}$ | 25°C | 2.55 | 2.62 | V | | |
| | | | Full Range | 2.53 | 0.130 | | | |
| | | $R_L = 2\text{ k}\Omega$ to 1.35 V $V_{IN} = \pm 100\text{ mV}$ | 25°C | 2.65 | 2.675 | V | | |
| | | | Full Range | 2.64 | 0.045 | | | |
| | | V_O | Output Swing LMV932-N-Q1 (Dual) LMV934-N-Q1 (Quad) | $R_L = 600\ \Omega$ to 1.35 V $V_{IN} = \pm 100\text{ mV}$ | 25°C | 2.55 | 2.62 | V |
| | | | | | Full Range | 2.53 | 0.187 | |
| $R_L = 2\text{ k}\Omega$ to 1.35 V $V_{IN} = \pm 100\text{ mV}$ | 25°C | | | 2.65 | 2.675 | V | | |
| | Full Range | | | 2.64 | 0.059 | | | |
| I_O | Output Short Circuit Current ⁽³⁾ | | | Sourcing, $V_O = 0\text{ V}$ $V_{IN} = +100\text{ mV}$ | 25°C | 20 | 30 | mA |
| | | | | | Full Range | 15 | | |
| | | Sinking, $V_O = 2.7\text{ V}$ $V_{IN} = -100\text{ mV}$ | 25°C | 18 | 25 | mA | | |
| | | | Full Range | 12 | | | | |

- (2) For specified temperature ranges, see the CMVR parameter in [DC Electrical Characteristics 1.8 V](#) for the input common-mode voltage specifications.
- (3) Applies to both single-supply and split-supply operation. Continuous short circuit operation at elevated ambient temperature can result in exceeding the maximum allowed junction temperature of 150°C. Output currents in excess of 45 mA over long term may adversely affect reliability.

6.8 AC Electrical Characteristics 2.7 V

Unless otherwise specified, all limits specified for $T_J = 25^\circ\text{C}$. $V^+ = 2.7\text{ V}$, $V^- = 0\text{ V}$, $V_{CM} = 1.0\text{ V}$, $V_O = 1.35\text{ V}$ and $R_L > 1\text{ M}\Omega$.

| PARAMETER | | TEST CONDITIONS | MIN | TYP ⁽¹⁾ | MAX | UNIT |
|-----------|------------------------------|---|-----|--------------------|-----|------------------------|
| SR | Slew Rate | See ⁽²⁾ | | 0.4 | | V/ μs |
| | | See ⁽²⁾ , LMV932-N-Q1 Only | | 0.36 | | V/ μs |
| GBW | Gain-Bandwidth Product | | | 1.4 | | MHz |
| Φ_m | Phase Margin | | | 70 | | deg |
| G_m | Gain Margin | | | 7.5 | | dB |
| e_n | Input-Referred Voltage Noise | $f = 10\text{ kHz}$, $V_{CM} = 0.5\text{ V}$ | | 57 | | nV/ $\sqrt{\text{Hz}}$ |
| i_n | Input-Referred Current Noise | $f = 10\text{ kHz}$ | | 0.08 | | pA/ $\sqrt{\text{Hz}}$ |
| THD | Total Harmonic Distortion | $f = 1\text{ kHz}$, $A_V = +1$ $R_L = 600\ \Omega$, $V_{IN} = 1\text{ V}_{PP}$ | | 0.022% | | |
| | Amp-to-Amp Isolation | See ⁽³⁾ | | 123 | | dB |

- (1) Typical values represent the most likely parametric norm as determined at the time of characterization. Actual typical values may vary over time and will also depend on the application and configuration.
- (2) Connected as voltage follower with input step from V^- to V^+ . Number specified is the slower of the positive and negative slew rates.
- (3) Input referred, $R_L = 100\text{ k}\Omega$ connected to $V^+/2$. Each amplifier excited in turn with 1 kHz to produce $V_O = 3\text{ V}_{PP}$ (For Supply Voltages $< 3\text{ V}$, $V_O = V^+$).

6.9 Electrical Characteristics 5 V DC

Unless otherwise specified, all limits specified for $T_J = 25^\circ\text{C}$. $V^+ = 5\text{ V}$, $V^- = 0\text{ V}$, $V_{CM} = V^+/2$, $V_O = V^+/2$ and $R_L > 1\text{ M}\Omega$.

| PARAMETER | | TEST CONDITIONS | | MIN | TYP ⁽¹⁾ | MAX | UNIT |
|------------|---|---|---------------|-------------|--------------------|------------------------------|---------------|
| V_{OS} | Input Offset Voltage | LMV931-N-Q1 (Single) | 25°C | | 1 | 4 | mV |
| | | | Full Range | | | 6 | |
| | | LMV932-N-Q1 (Dual) LMV934-N-Q1 (Quad) | 25°C | | 1 | 5.5 | mV |
| | | | Full Range | | | 7.5 | |
| TCV_{OS} | Input Offset Voltage Average Drift | | | 5.5 | | $\mu\text{V}/^\circ\text{C}$ | |
| I_B | Input Bias Current | | 25°C | | 14 | 35 | nA |
| | | | Full Range | | | 50 | |
| I_{OS} | Input Offset Current | | 25°C | | 9 | 25 | nA |
| | | | Full Range | | | 40 | |
| I_S | Supply Current (per channel) | | 25°C | | 116 | 210 | μA |
| | | | Full Range | | | 230 | |
| $CMRR$ | Common-Mode Rejection Ratio | $0 \leq V_{CM} \leq 3.8\text{ V}$ $4.6\text{ V} \leq V_{CM} \leq 5.0\text{ V}^{(2)}$ | 25°C | 60 | 86 | dB | |
| | | | Full Range | 55 | | | |
| | | $-0.2\text{ V} \leq V_{CM} \leq 0\text{ V}$ $5.0\text{ V} \leq V_{CM} \leq 5.2\text{ V}$ | 25°C | 50 | 78 | dB | |
| | | | Full Range | | | | |
| $PSRR$ | Power Supply Rejection Ratio | $1.8\text{ V} \leq V^+ \leq 5\text{ V}$ $V_{CM} = 0.5\text{ V}$ | 25°C | 75 | 100 | dB | |
| | | | Full Range | 70 | | | |
| $CMVR$ | Input Common-Mode Voltage Range | For $CMRR$ Range $\geq 50\text{ dB}$ | 25°C | $V^- - 0.2$ | -0.2 | $\frac{V^+ + 0.2}{V^+}$ | V |
| | | | -40°C to 85°C | V^- | to | V^+ | |
| | | | 125°C | $V^- + 0.3$ | 5.3 | $V^+ - 0.3$ | |
| A_V | Large Signal Voltage Gain LMV931-N-Q1 (Single) | $R_L = 600\ \Omega$ to 2.5 V, $V_O = 0.2\text{ V}$ to 4.8 V | 25°C | 88 | 102 | dB | |
| | | | Full Range | 87 | | | |
| | | $R_L = 2\text{ k}\Omega$ to 2.5 V, $V_O = 0.2\text{ V}$ to 4.8 V | 25°C | 94 | 113 | dB | |
| | | | Full Range | 93 | | | |
| | Large Signal Voltage Gain LMV932-N-Q1 (Dual) LMV934-N-Q1 (Quad) | $R_L = 600\ \Omega$ to 2.5 V, $V_O = 0.2\text{ V}$ to 4.8 V | 25°C | 81 | 90 | dB | |
| | | | Full Range | 78 | | | |
| | | $R_L = 2\text{ k}\Omega$ to 2.5 V, $V_O = 0.2\text{ V}$ to 4.8 V | 25°C | 85 | 100 | dB | |
| | | | Full Range | 82 | | | |
| V_O | Output Swing LMV931-N-Q1 (Single) | $R_L = 600\ \Omega$ to 2.5 V $V_{IN} = \pm 100\text{ mV}$ | 25°C | 4.855 | 4.890 | V | |
| | | | Full Range | 4.835 | 0.180 | | |
| | | | 25°C | 4.945 | 4.967 | | |
| | | $R_L = 2\text{ k}\Omega$ to 2.5 V $V_{IN} = \pm 100\text{ mV}$ | 25°C | | 0.037 | 0.065 | V |
| | | | Full Range | 4.935 | 0.075 | | |
| | | | 25°C | 4.855 | 4.890 | V | |
| Full Range | 4.807 | 0.218 | | | | | |
| | 25°C | 4.945 | 4.967 | V | | | |
| | Full Range | 4.935 | 0.075 | | | | |

(1) Typical values represent the most likely parametric norm as determined at the time of characterization. Actual typical values may vary over time and will also depend on the application and configuration.

(2) For specified temperature ranges, see the $CMVR$ parameter in [DC Electrical Characteristics 1.8 V](#) for the input common-mode voltage specifications.

Electrical Characteristics 5 V DC (continued)

Unless otherwise specified, all limits specified for $T_J = 25^\circ\text{C}$. $V^+ = 5\text{ V}$, $V^- = 0\text{ V}$, $V_{CM} = V^+/2$, $V_O = V^+/2$ and $R_L > 1\text{ M}\Omega$.

| PARAMETER | | TEST CONDITIONS | | MIN | TYP ⁽¹⁾ | MAX | UNIT |
|-----------|---|---|------------|-----|--------------------|-----|------|
| I_O | Output Short Circuit Current ⁽³⁾ | LMV931-N-Q1, Sourcing, $V_O = 0\text{ V}$ $V_{IN} = +100\text{ mV}$ | 25°C | 80 | 100 | | mA |
| | | | Full Range | 68 | | | |
| | | Sinking, $V_O = 5\text{ V}$ $V_{IN} = -100\text{ mV}$ | 25°C | 58 | 65 | | mA |
| | | | Full Range | 45 | | | |

(3) Applies to both single-supply and split-supply operation. Continuous short circuit operation at elevated ambient temperature can result in exceeding the maximum allowed junction temperature of 150°C. Output currents in excess of 45 mA over long term may adversely affect reliability.

6.10 AC Electrical Characteristics 5 V

Unless otherwise specified, all limits specified for $T_J = 25^\circ\text{C}$. $V^+ = 5\text{ V}$, $V^- = 0\text{ V}$, $V_{CM} = V^+/2$, $V_O = 2.5\text{ V}$ and $R_L > 1\text{ M}\Omega$.

| PARAMETER | | TEST CONDITIONS | | MIN | TYP ⁽¹⁾ | MAX | UNIT |
|-----------|----------------------------------|---|--|-----|--------------------|-----|------------------------|
| SR | Slew Rate | See . ⁽²⁾ | | | 0.42 | | V/ μs |
| | | See . ⁽²⁾ , LMV932-N-Q1 Only | | | 0.48 | | V/ μs |
| GBW | Gain-Bandwidth Product | | | | 1.5 | | MHz |
| Φ_m | Phase Margin | | | | 71 | | deg |
| G_m | Gain Margin | | | | 8 | | dB |
| e_n | Input-Referred Voltage Noise | $f = 10\text{ kHz}$, $V_{CM} = 1\text{ V}$ | | | 50 | | nV/ $\sqrt{\text{Hz}}$ |
| i_n | Input-Referred Current Noise | $f = 10\text{ kHz}$ | | | 0.08 | | pA/ $\sqrt{\text{Hz}}$ |
| THD | Total Harmonic Distortion | $f = 1\text{ kHz}$, $A_V = 1$ $R_L = 600\ \Omega$, $V_O = 1\text{ V}_{PP}$ | | | 0.022% | | |
| | Amplifier-to-Amplifier Isolation | See ⁽³⁾ | | | 123 | | dB |

- (1) Typical values represent the most likely parametric norm as determined at the time of characterization. Actual typical values may vary over time and will also depend on the application and configuration.
- (2) Connected as voltage follower with input step from V^- to V^+ . Number specified is the slower of the positive and negative slew rates.
- (3) Input referred, $R_L = 100\text{ k}\Omega$ connected to $V^+/2$. Each amplifier excited in turn with 1 kHz to produce $V_O = 3\text{ V}_{PP}$ (For Supply Voltages $< 3\text{ V}$, $V_O = V^+$).

6.11 Typical Characteristics

Unless otherwise specified, $V_S = 5\text{ V}$, single-supply, $T_A = 25^\circ\text{C}$.

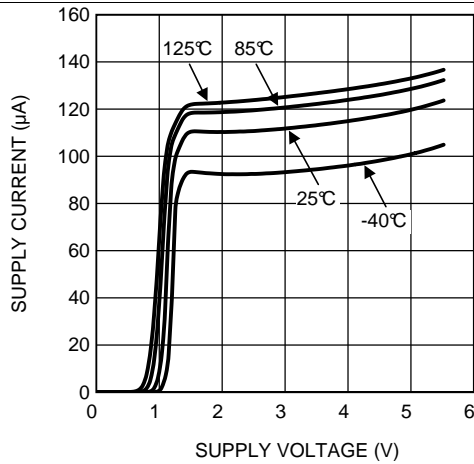

Figure 1. Supply Current vs. Supply Voltage (LMV931-N)

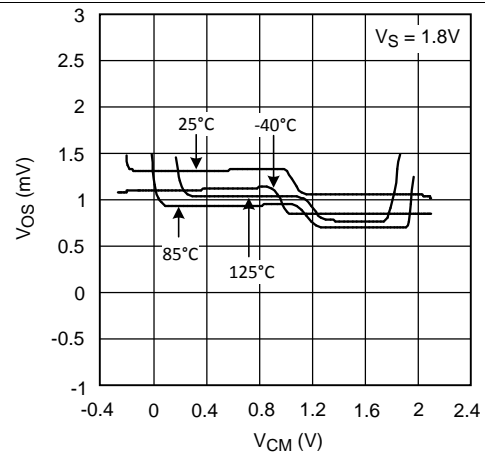

Figure 2. Offset Voltage vs. Common-Mode Range

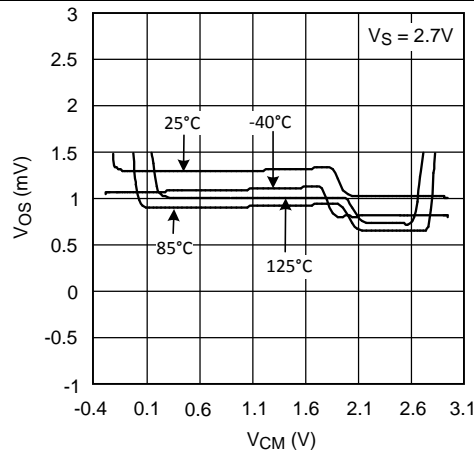

Figure 3. Offset Voltage vs. Common-Mode Range

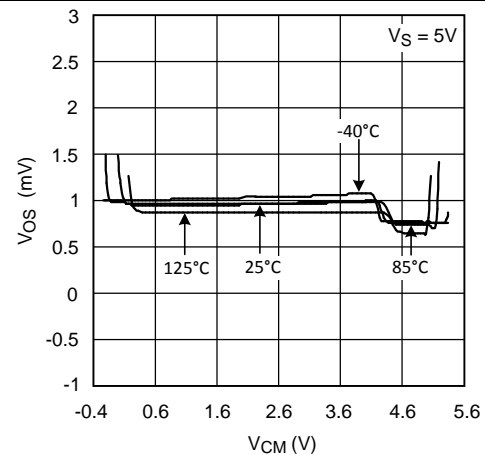

Figure 4. Offset Voltage vs. Common-Mode Range

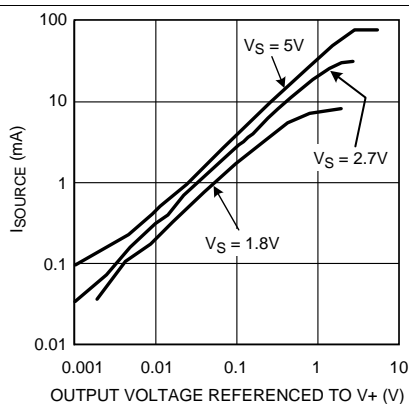

Figure 5. Sourcing Current vs. Output Voltage

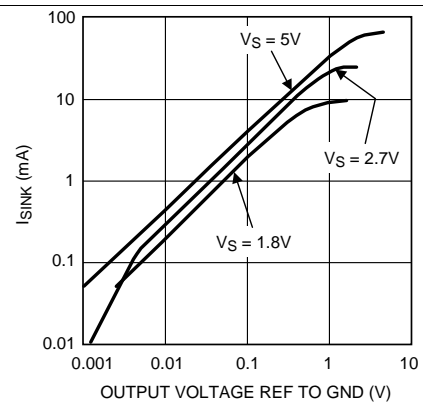

Figure 6. Sinking Current vs. Output Voltage

Typical Characteristics (continued)

Unless otherwise specified, $V_S = 5\text{ V}$, single-supply, $T_A = 25^\circ\text{C}$.

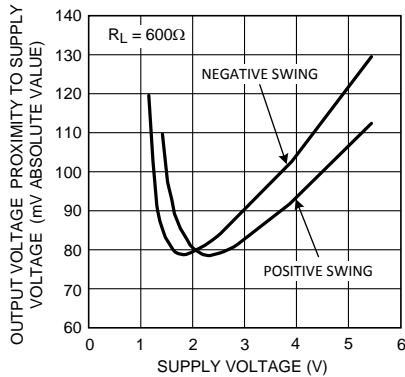

Figure 7. Output Voltage Swing vs. Supply Voltage

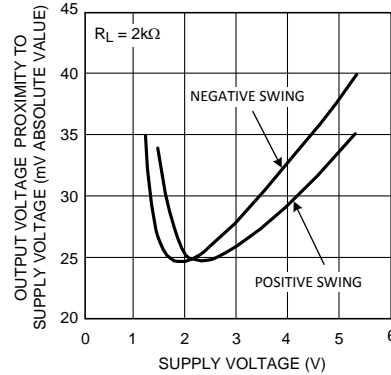

Figure 8. Output Voltage Swing vs. Supply Voltage

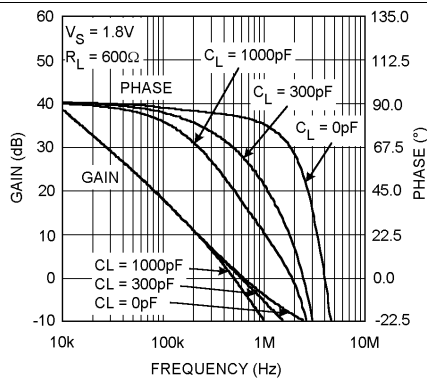

Figure 9. Gain and Phase vs. Frequency

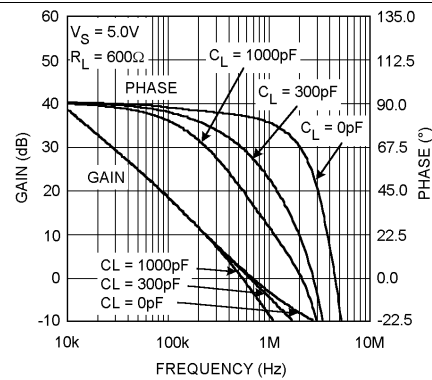

Figure 10. Gain and Phase vs. Frequency

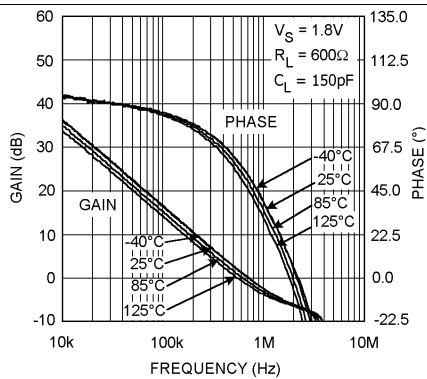

Figure 11. Gain and Phase vs. Frequency

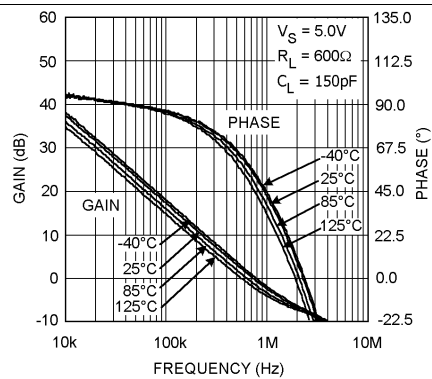

Figure 12. Gain and Phase vs. Frequency

Typical Characteristics (continued)

Unless otherwise specified, $V_S = 5\text{ V}$, single-supply, $T_A = 25^\circ\text{C}$.

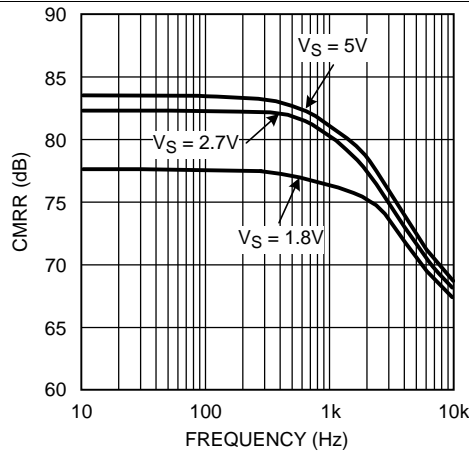

Figure 13. CMRR vs. Frequency

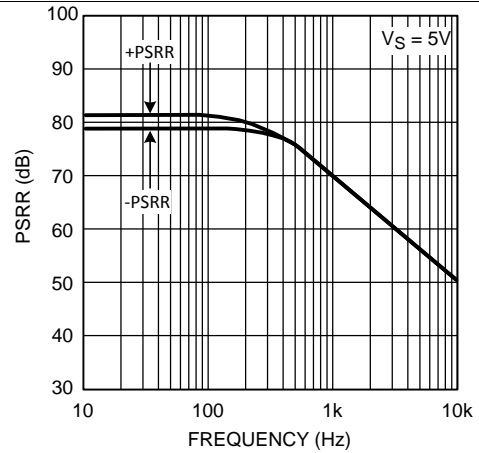

Figure 14. PSRR vs. Frequency

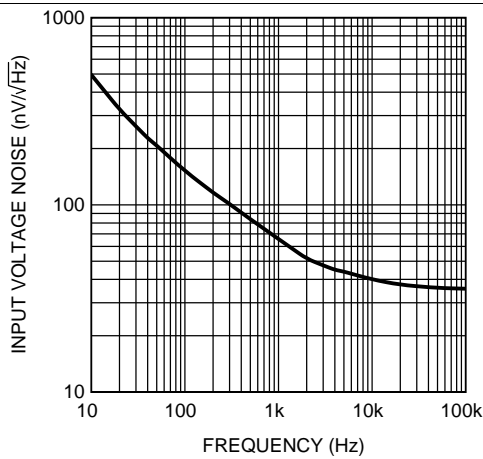

Figure 15. Input Voltage Noise vs. Frequency

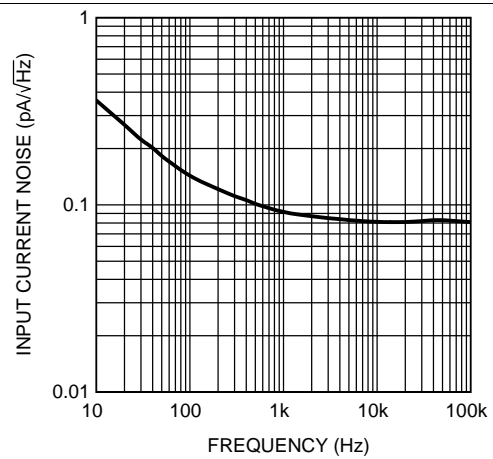

Figure 16. Input Current Noise vs. Frequency

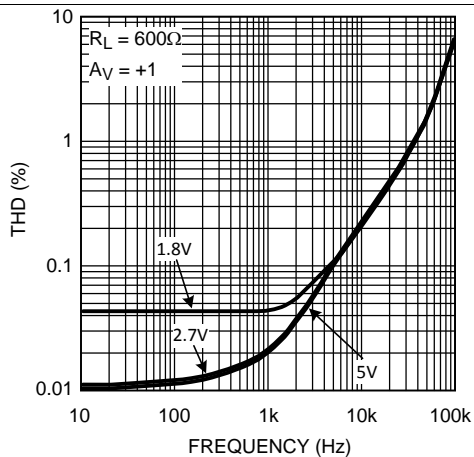

Figure 17. THD vs. Frequency

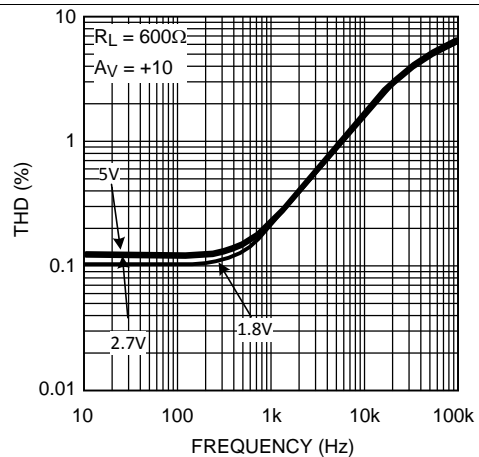
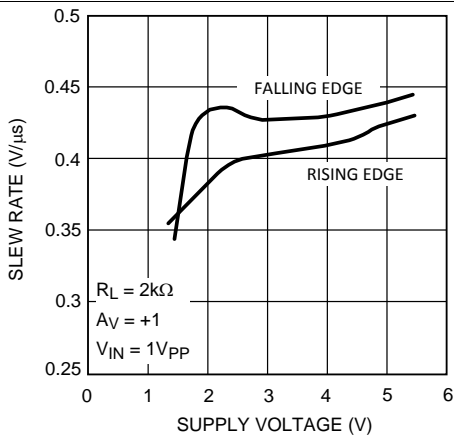

Figure 18. THD vs. Frequency

Typical Characteristics (continued)

Unless otherwise specified, $V_S = 5\text{ V}$, single-supply, $T_A = 25^\circ\text{C}$.



**Figure 19. Slew Rate vs. Supply Voltage
LMV931-N-Q1 and LMV934-N-Q1**

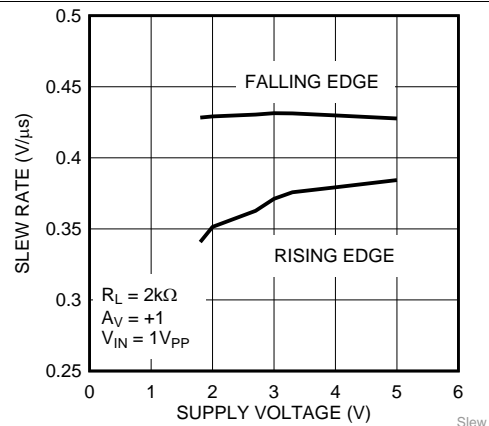

**Figure 20. Slew Rate vs. Supply Voltage
LMV932-N-Q1 Only**

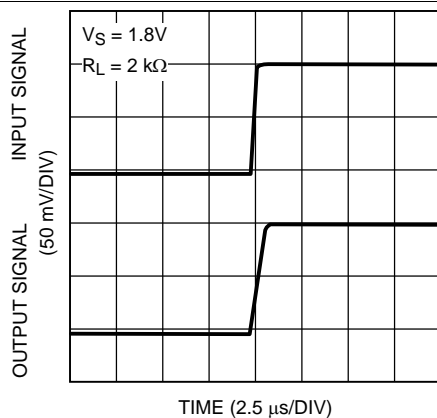

Figure 21. Small Signal Noninverting Response

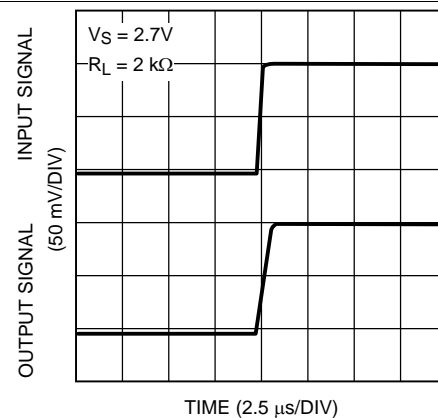

Figure 22. Small Signal Noninverting Response

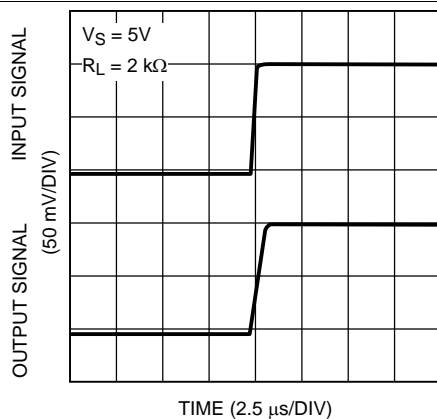

Figure 23. Small Signal Noninverting Response

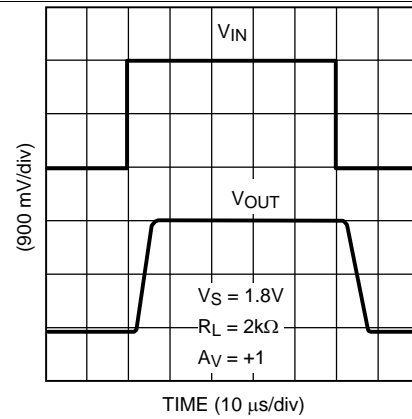

Figure 24. Large Signal Noninverting Response

Typical Characteristics (continued)

Unless otherwise specified, $V_S = 5\text{ V}$, single-supply, $T_A = 25^\circ\text{C}$.

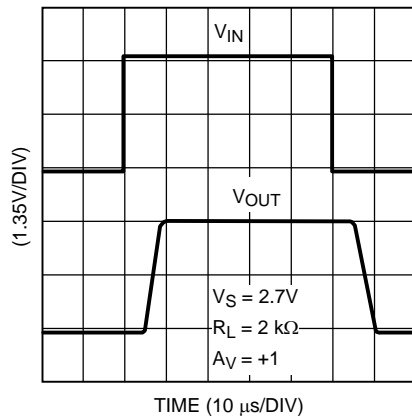

Figure 25. Large Signal Noninverting Response

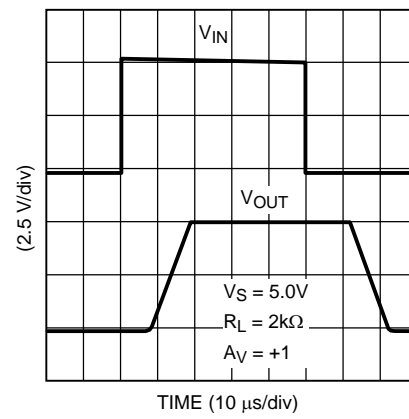

Figure 26. Large Signal Noninverting Response

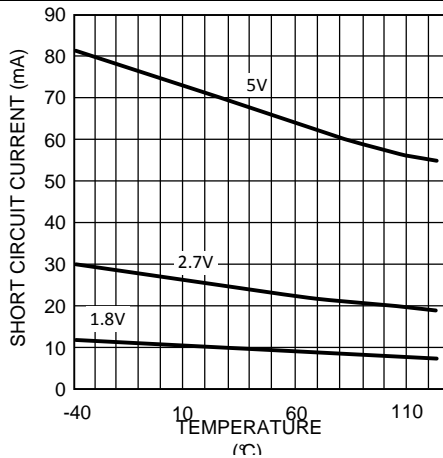

Figure 27. Short Circuit Current vs. Temperature (Sinking)

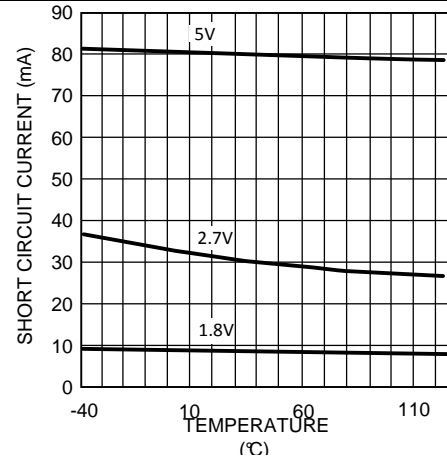

Figure 28. Short Circuit Current vs. Temperature (Sourcing)

7 Detailed Description

7.1 Overview

The LMV93x-Q1-N are low-voltage, low-power operational amplifiers (op-amp) operating from 1.8-V to 5.5-V supply voltages and have rail-to-rail input and output. LMV93x-Q1-N input common-mode voltage extends 200 mV beyond the supplies which enables user enhanced functionality beyond the supply voltage range.

7.2 Functional Block Diagram

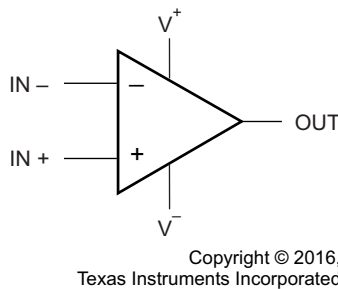

(Each Amplifier)

7.3 Feature Description

The differential inputs of the amplifier consist of a noninverting input (+IN) and an inverting input (–IN). The amplifier amplifies only the difference in voltage between the two inputs, which is called the differential input voltage. The output voltage of the op-amp V_{OUT} is given by [Equation 1](#):

$$V_{OUT} = A_{OL} (IN^+ - IN^-)$$

where

- A_{OL} is the open-loop gain of the amplifier, typically around 100 dB (100,000x, or 10 μ V per volt). (1)

7.4 Device Functional Modes

7.4.1 Input and Output Stage

The rail-to-rail input stage of this family provides more flexibility for the designer. The LMV93x-Q1-N use a complimentary PNP and NPN input stage in which the PNP stage senses common-mode voltage near V^- and the NPN stage senses common-mode voltage near V^+ . The transition from the PNP stage to NPN stage occurs 1 V below V^+ . Because both input stages have their own offset voltage, the offset of the amplifier becomes a function of the input common-mode voltage and has a crossover point at 1 V below V^+ .

Device Functional Modes (continued)

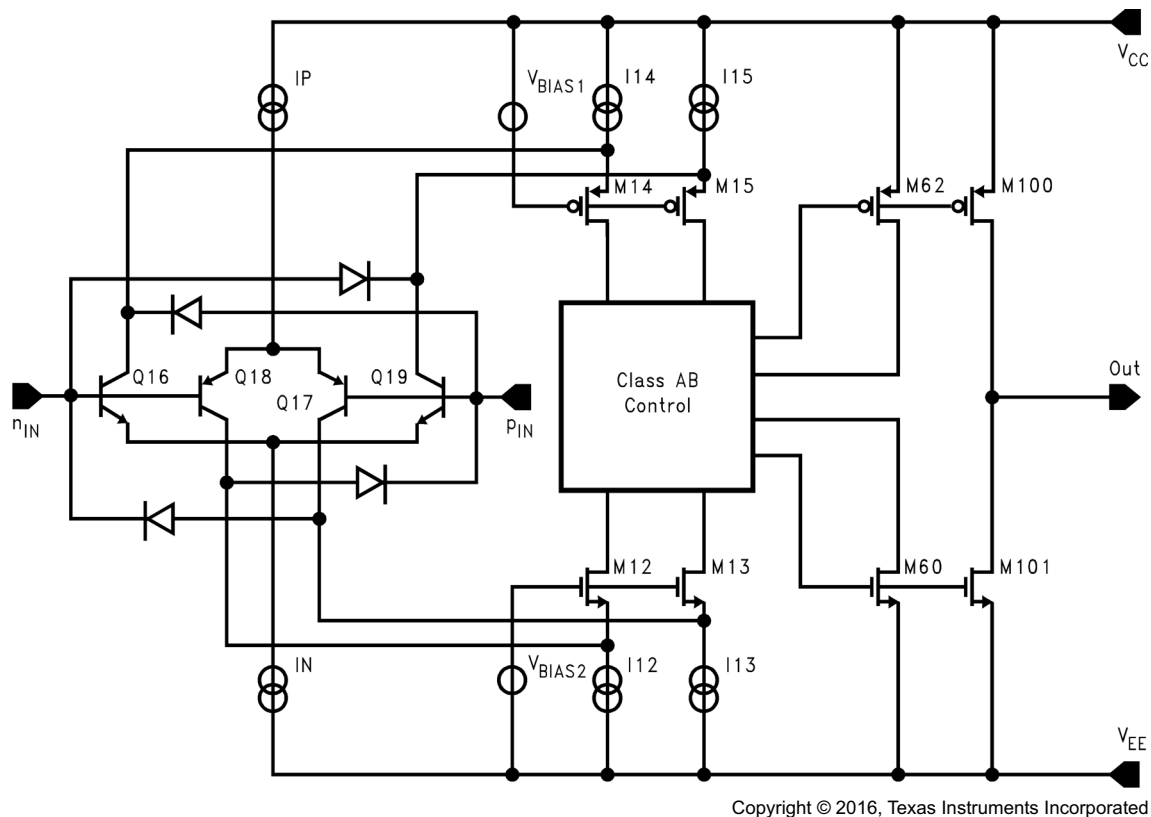

Figure 29. Simplified Schematic Diagram

This V_{OS} crossover point can create problems for both DC- and AC-coupled signals if proper care is not taken. Large input signals that include the V_{OS} crossover point will cause distortion in the output signal. One way to avoid such distortion is to keep the signal away from the crossover. For example, in a unity gain buffer configuration with $V_S = 5\text{ V}$, a 5-V peak-to-peak signal will contain input-crossover distortion while a 3-V peak-to-peak signal centered at 1.5 V will not contain input-crossover distortion as it avoids the crossover point. Another way to avoid large signal distortion is to use a gain of -1 circuit which avoids any voltage excursions at the input terminals of the amplifier. In that circuit, the common-mode DC voltage can be set at a level away from the V_{OS} cross-over point. For small signals, this transition in V_{OS} shows up as a V_{CM} dependent spurious signal in series with the input signal and can effectively degrade small signal parameters such as gain and common-mode rejection ratio. To resolve this problem, the small signal should be placed such that it avoids the V_{OS} crossover point. In addition to the rail-to-rail performance, the output stage can provide enough output current to drive 600- Ω loads. Because of the high-current capability, take care not to exceed the 150°C maximum junction temperature specification.

7.4.2 Input Bias Current Consideration

The LMV93x-Q1-N family has a complementary bipolar input stage. The typical input bias current (I_B) is 15 nA. The input bias current can develop a significant offset voltage. This offset is primarily due to I_B flowing through the negative feedback resistor, R_F . For example, if I_B is 50 nA and R_F is 100 k Ω , then an offset voltage of 5 mV will develop ($V_{OS} = I_B \times R_F$). Using a compensation resistor (R_C), as shown in Figure 30, cancels this effect. But the input offset current (I_{OS}) will still contribute to an offset voltage in the same manner.

Device Functional Modes (continued)

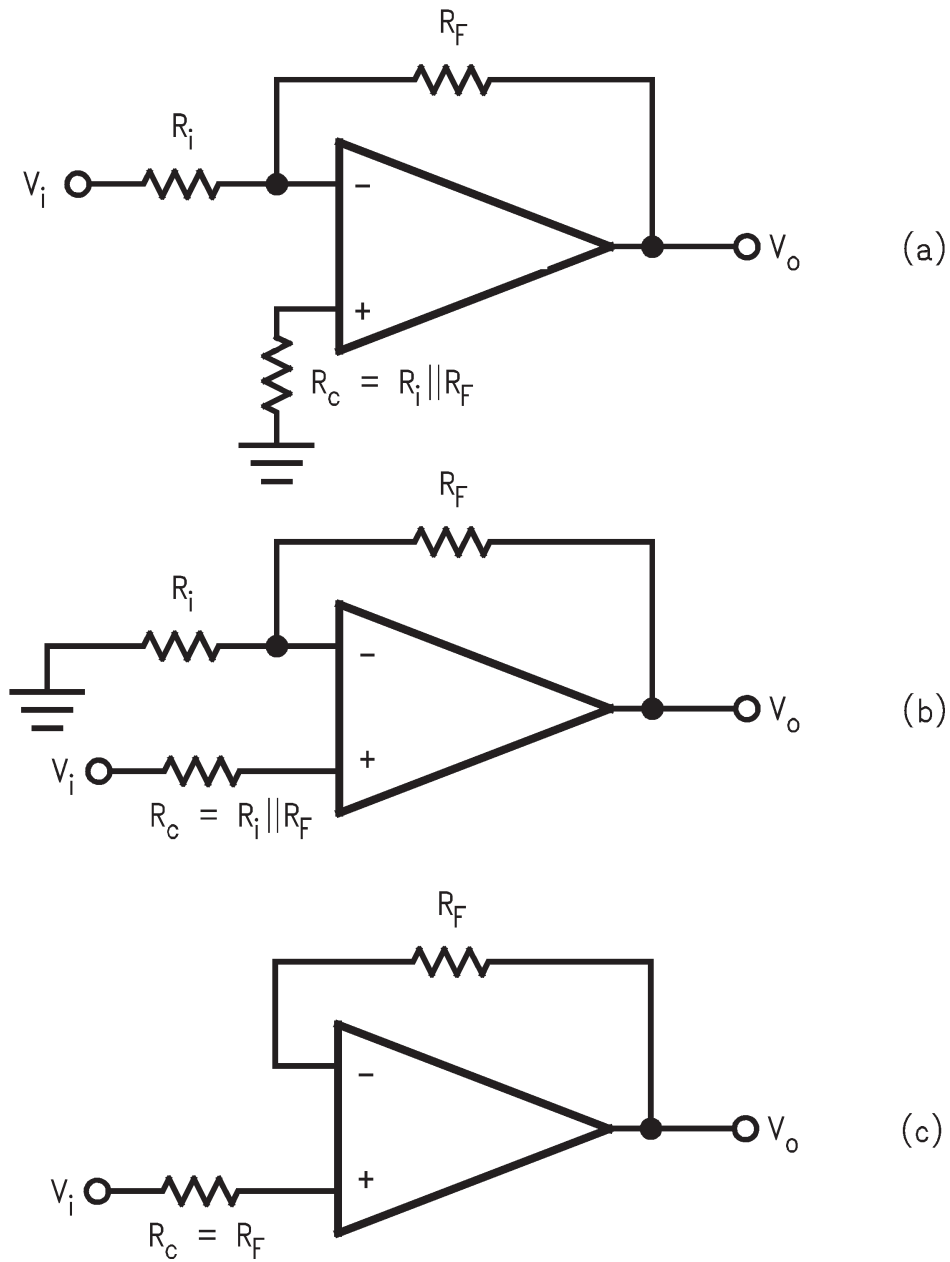

Figure 30. Canceling the Offset Voltage due to Input Bias Current

8 Application and Implementation

NOTE

Information in the following applications sections is not part of the TI component specification, and TI does not warrant its accuracy or completeness. TI's customers are responsible for determining suitability of components for their purposes. Customers should validate and test their design implementation to confirm system functionality.

8.1 Application Information

The LMV93x-Q1-N devices bring performance, economy and ease-of-use to low-voltage, low-power systems. They provide rail-to-rail input and rail-to-rail output swings into heavy loads.

8.2 Typical Applications

8.2.1 High-Side Current-Sensing Application

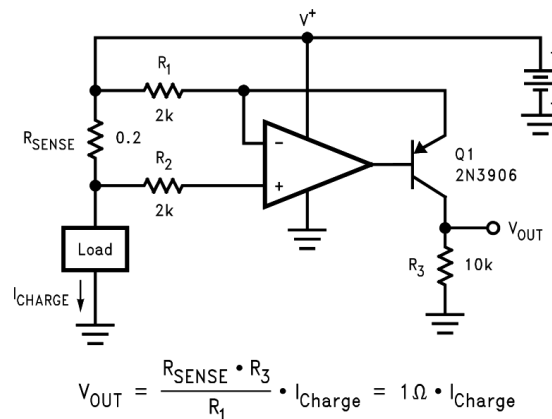

Figure 31. High-Side Current Sensing

8.2.1.1 Design Requirements

The high-side current-sensing circuit (Figure 31) is commonly used in a battery charger to monitor charging current to prevent overcharging. A sense resistor R_{SENSE} is connected to the battery directly. This system requires an op amp with rail-to-rail input. The LMV93x-Q1-N are ideal for this application because its common-mode input range extends up to the positive supply.

8.2.1.1.1 Custom Design With WEBENCH® Tools

Click [here](#) to create a custom design using the LMV93x-Q1-N device with the WEBENCH® Power Designer.

1. Start by entering the input voltage (V_{IN}), output voltage (V_{OUT}), and output current (I_{OUT}) requirements.
2. Optimize the design for key parameters such as efficiency, footprint, and cost using the optimizer dial.
3. Compare the generated design with other possible solutions from Texas Instruments.

The WEBENCH Power Designer provides a customized schematic along with a list of materials with real-time pricing and component availability.

In most cases, these actions are available:

- Run electrical simulations to see important waveforms and circuit performance
- Run thermal simulations to understand board thermal performance
- Export customized schematic and layout into popular CAD formats
- Print PDF reports for the design, and share the design with colleagues

Get more information about WEBENCH tools at www.ti.com/WBENCH.

Typical Applications (continued)

8.2.1.2 Detailed Design Procedure

As seen in [Figure 31](#), the I_{CHARGE} current flowing through sense resistor R_{SENSE} develops a voltage drop equal to V_{SENSE} . The voltage at the negative sense point will now be less than the positive sense point by an amount proportional to the V_{SENSE} voltage.

The low-bias currents of the LMV93x-Q1-Q1 cause little voltage drop through R_2 , so the negative input of the LMV93x-Q1 amplifier is at essentially the same potential as the negative sense input.

The LMV93x-Q1 will detect this voltage error between its inputs and servo the transistor base to conduct more current through Q1, increasing the voltage drop across R_1 until the LMV93x-Q1 inverting input matches the noninverting input. At this point, the voltage drop across R_1 now matches V_{SENSE} .

I_G , a current proportional to I_{CHARGE} , will flow according to the following relation:

$$I_G = V_{\text{RSENSE}} / R_1 = (R_{\text{SENSE}} * I_{\text{CHARGE}}) / R_1 \quad (2)$$

I_G also flows through the gain resistor R_3 developing a voltage drop equal to:

$$V_3 = I_G * R_3 = (V_{\text{RSENSE}} / R_1) * R_3 = ((R_{\text{SENSE}} * I_{\text{CHARGE}}) / R_2) * R_3 \quad (3)$$

$$V_{\text{OUT}} = (R_{\text{SENSE}} * I_{\text{CHARGE}}) * G$$

where

- $G = R_3 / R_1$ (4)

The other channel of the LMV93x-Q1 may be used to buffer the voltage across R_3 to drive the following stages.

8.2.1.3 Application Curve

[Figure 32](#) shows the results of the example current sense circuit.

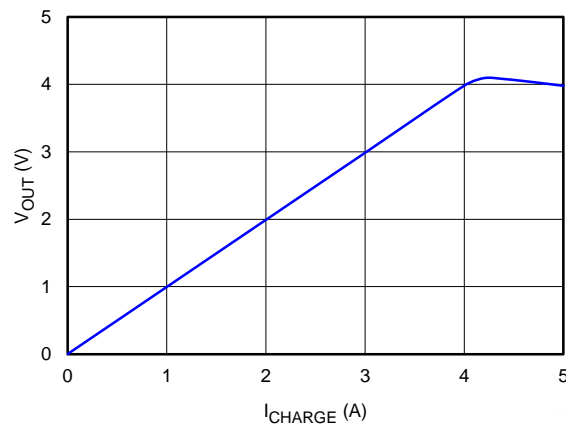

NOTE: the error after 4 V where transistor Q1 runs out of headroom and saturates, limiting the upper output swing.

Figure 32. Current Sense Amplifier Results

Typical Applications (continued)

8.2.2 Half-Wave Rectifier Applications

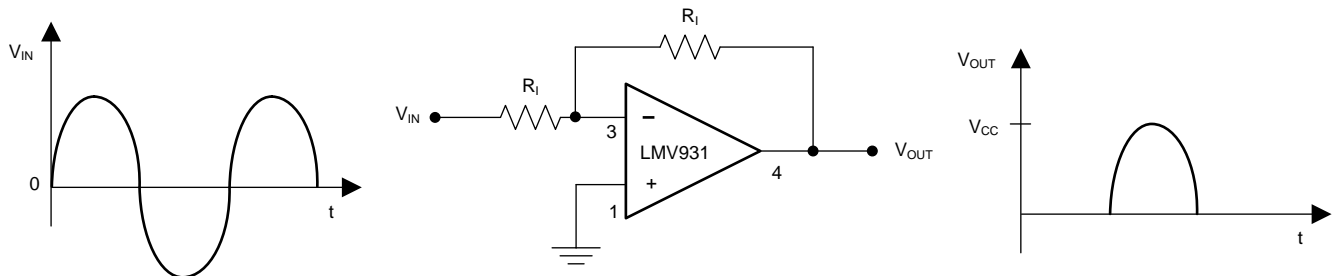

Figure 33. Half-Wave Rectifier With Rail-To-Ground Output Swing Referenced to Ground

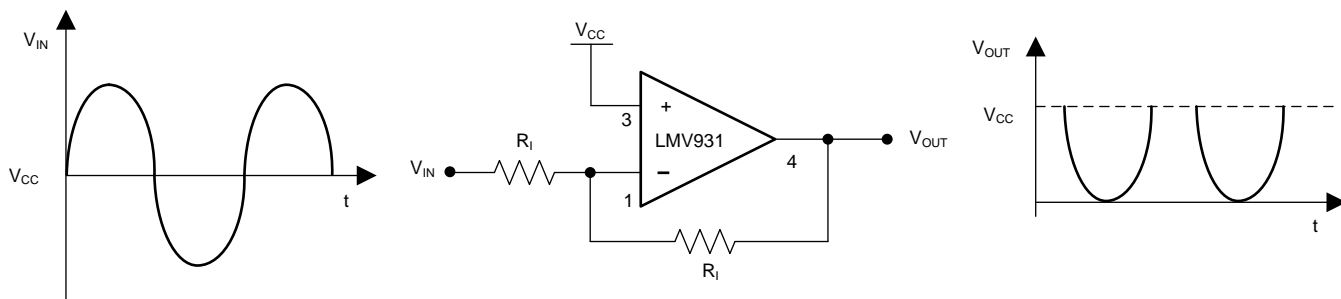

Figure 34. Half-Wave Rectifier With Negative-Going Output Referenced to V_{CC}

8.2.2.1 Design Requirements

Because the LMV931-N-Q1, LMV932-N-Q1, LMV934-N-Q1 input common-mode range includes both positive and negative supply rails and the output can also swing to either supply, achieving half-wave rectifier functions in either direction is an easy task. All that is needed are two external resistors; there is no need for diodes or matched resistors. The half-wave rectifier can have either positive or negative going outputs, depending on the way the circuit is arranged.

8.2.2.2 Detailed Design Procedure

In [Figure 33](#) the circuit is referenced to ground, while in [Figure 34](#) the circuit is biased to the positive supply. These configurations implement the half-wave rectifier because the LMV93x-Q1-N can not respond to one-half of the incoming waveform. It can not respond to one-half of the incoming because the amplifier cannot swing the output beyond either rail therefore the output disengages during this half cycle. During the other half cycle, however, the amplifier achieves a half wave that can have a peak equal to the total supply voltage. R_I should be large enough not to load the LMV93x-Q1-N.

8.2.2.3 Application Curve

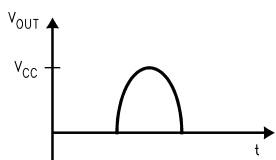

Figure 35. Output of Ground-to-Rail Circuit

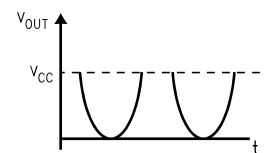

Figure 36. Output of Rail-to-Ground Circuit

Typical Applications (continued)

8.2.3 Instrumentation Amplifier With Rail-to-Rail Input and Output Application

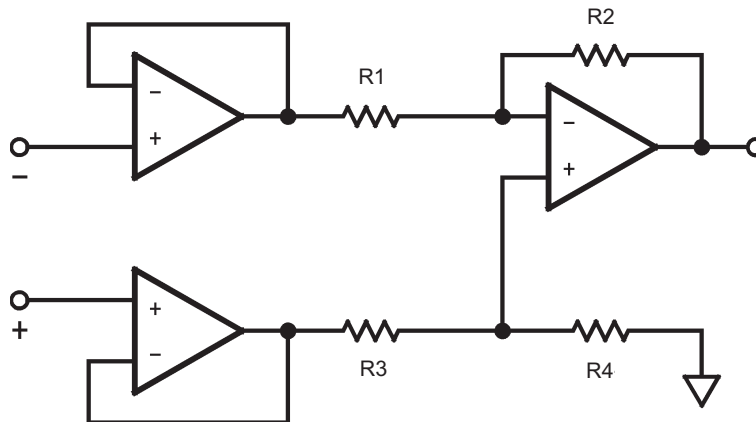

Figure 37. Rail-to-Rail Instrumentation Amplifier

8.2.3.1 Design Requirements

Using three of the LMV93x-Q1-N amplifiers, an instrumentation amplifier with rail-to-rail inputs and outputs can be made as shown in Figure 37.

8.2.3.2 Detailed Design Procedure

In this example, amplifiers on the left side act as buffers to the differential stage. These buffers assure that the input impedance is very high. They also assure that the difference amp is driven from a voltage source. This is necessary to maintain the CMRR set by the matching R_1 - R_2 with R_3 - R_4 . The gain is set by the ratio of R_2 / R_1 and R_3 must equal R_4 and R_4 equal R_2 . With both rail-to-rail input and output ranges, the input and output are only limited by the supply voltages. Remember that even with rail-to-rail outputs, the output can not swing past the supplies so the combined common-mode voltages plus the signal must not be greater than the supplies or limiting will occur.

8.2.3.3 Application Curve

Figure 38 shows the results of the instrumentation amplifier with R_1 and $R_3 = 1\text{ K}$, and R_2 and $R_4 = 100\text{ k}\Omega$, for a gain of 100, running on a single 5-V supply with a input of $V_{CM} = V_S/2$. The combined effects of the individual offset voltages can be seen as a shift in the offset of the curve.

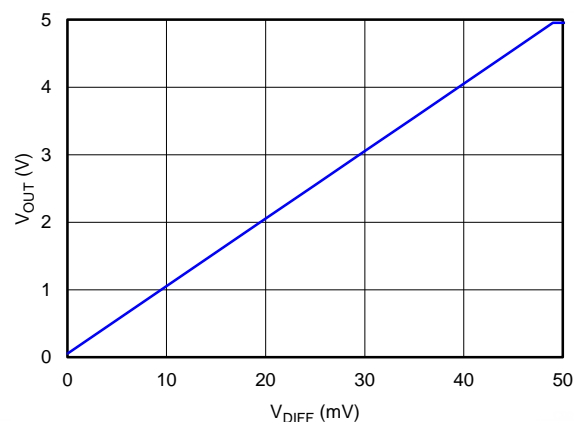

Figure 38. Instrumentation Amplifier Output Results

8.3 Dos and Don'ts

Do properly bypass the power supplies.

Do add series resistance to the output when driving capacitive loads, particularly cables, Muxes and ADC inputs.

Do add series current limiting resistors and external schottky clamp diodes if input voltage is expected to exceed the supplies. Limit the current to 1 mA or less (1 k Ω per volt).

9 Power Supply Recommendations

For proper operation, the power supplies must be properly decoupled. For decoupling the supply lines, TI recommends that 10-nF capacitors be placed as close as possible to the op amp power supply pins. For single-supply, place a capacitor between V^+ and V^- supply leads. For dual supplies, place one capacitor between V^+ and ground, and one capacitor between V^- and ground.

10 Layout

10.1 Layout Guidelines

The V^+ pin must be bypassed to ground with a low-ESR capacitor.

The optimum placement is closest to the V^+ and ground pins.

Take care to minimize the loop area formed by the bypass capacitor connection between V^+ and ground.

The ground pin must be connected to the PCB ground plane at the pin of the device.

The feedback components should be placed as close as possible to the device minimizing strays.

10.2 Layout Example

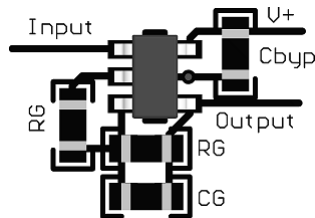

Figure 39. SOT-23 Layout Example

11 Device and Documentation Support

11.1 Device Support

11.1.1 Custom Design With WEBENCH® Tools

[Click here](#) to create a custom design using the LMV93x-N-Q1 device with the WEBENCH® Power Designer.

1. Start by entering the input voltage (V_{IN}), output voltage (V_{OUT}), and output current (I_{OUT}) requirements.
2. Optimize the design for key parameters such as efficiency, footprint, and cost using the optimizer dial.
3. Compare the generated design with other possible solutions from Texas Instruments.

The WEBENCH Power Designer provides a customized schematic along with a list of materials with real-time pricing and component availability.

In most cases, these actions are available:

- Run electrical simulations to see important waveforms and circuit performance
- Run thermal simulations to understand board thermal performance
- Export customized schematic and layout into popular CAD formats
- Print PDF reports for the design, and share the design with colleagues

Get more information about WEBENCH tools at www.ti.com/WEBENCH.

11.1.2 Development Support

LMV931 PSPICE Model (also applicable to the LMV931-N-Q1, LMV932-N-Q1 and LMV934-N-Q1), <http://www.ti.com/lit/zip/snom028>

TINA-TI SPICE-Based Analog Simulation Program, <http://www.ti.com/tool/tina-ti>

DIP Adapter Evaluation Module, <http://www.ti.com/tool/dip-adapter-evm>

TI Universal Operational Amplifier Evaluation Module, <http://www.ti.com/tool/opampevm>

TI Filterpro Software, <http://www.ti.com/tool/filterpro>

11.2 Documentation Support

11.2.1 Related Documentation

For additional applications, see

[AN-31 Op Amp Circuit Collection](#)

11.3 Related Links

Table 1 lists quick access links. Categories include technical documents, support and community resources, tools and software, and quick access to order now.

Table 1. Related Links

| PARTS | PRODUCT FOLDER | ORDER NOW | TECHNICAL DOCUMENTS | TOOLS & SOFTWARE | SUPPORT & COMMUNITY |
|-------------|----------------------------|----------------------------|----------------------------|----------------------------|----------------------------|
| LMV931-N-Q1 | Click here | Click here | Click here | Click here | Click here |
| LMV932-N-Q1 | Click here | Click here | Click here | Click here | Click here |
| LMV934-N-Q1 | Click here | Click here | Click here | Click here | Click here |

11.4 Receiving Notification of Documentation Updates

To receive notification of documentation updates, navigate to the device product folder on ti.com. In the upper right corner, click on *Alert me* to register and receive a weekly digest of any product information that has changed. For change details, review the revision history included in any revised document.

11.5 Community Resources

The following links connect to TI community resources. Linked contents are provided "AS IS" by the respective contributors. They do not constitute TI specifications and do not necessarily reflect TI's views; see TI's [Terms of Use](#).

TI E2E™ Online Community *TI's Engineer-to-Engineer (E2E) Community*. Created to foster collaboration among engineers. At e2e.ti.com, you can ask questions, share knowledge, explore ideas and help solve problems with fellow engineers.

Design Support *TI's Design Support* Quickly find helpful E2E forums along with design support tools and contact information for technical support.

11.6 Trademarks

E2E is a trademark of Texas Instruments.
WEBENCH is a registered trademark of Texas Instruments.
All other trademarks are the property of their respective owners.

11.7 Electrostatic Discharge Caution



These devices have limited built-in ESD protection. The leads should be shorted together or the device placed in conductive foam during storage or handling to prevent electrostatic damage to the MOS gates.

11.8 Glossary

[SLYZ022](#) — *TI Glossary*.

This glossary lists and explains terms, acronyms, and definitions.

12 Mechanical, Packaging, and Orderable Information

The following pages include mechanical, packaging, and orderable information. This information is the most current data available for the designated devices. This data is subject to change without notice and revision of this document. For browser-based versions of this data sheet, refer to the left-hand navigation.

PACKAGING INFORMATION

| Orderable Device | Status (1) | Package Type | Package Drawing | Pins | Package Qty | Eco Plan (2) | Lead/Ball Finish (6) | MSL Peak Temp (3) | Op Temp (°C) | Device Marking (4/5) | Samples |
|------------------|---------------|--------------|-----------------|------|-------------|-------------------------|-------------------------|----------------------|--------------|-------------------------|-------------------------|
| LMV931Q1MF/NOPB | ACTIVE | SOT-23 | DBV | 5 | 1000 | Green (RoHS & no Sb/Br) | CU SN | Level-1-260C-UNLIM | -40 to 125 | ALAA | Samples |
| LMV931Q1MFX/NOPB | ACTIVE | SOT-23 | DBV | 5 | 3000 | Green (RoHS & no Sb/Br) | CU SN | Level-1-260C-UNLIM | -40 to 125 | ALAA | Samples |
| LMV931Q1MG/NOPB | ACTIVE | SC70 | DCK | 5 | 1000 | Green (RoHS & no Sb/Br) | CU SN | Level-1-260C-UNLIM | -40 to 125 | BBA | Samples |
| LMV931Q1MGX/NOPB | ACTIVE | SC70 | DCK | 5 | 3000 | Green (RoHS & no Sb/Br) | CU SN | Level-1-260C-UNLIM | -40 to 125 | BBA | Samples |
| LMV932Q1MA/NOPB | ACTIVE | SOIC | D | 8 | 95 | Green (RoHS & no Sb/Br) | CU SN | Level-1-260C-UNLIM | -40 to 125 | LMV93 2Q1MA | Samples |
| LMV932Q1MAX/NOPB | ACTIVE | SOIC | D | 8 | 2500 | Green (RoHS & no Sb/Br) | CU SN | Level-1-260C-UNLIM | -40 to 125 | LMV93 2Q1MA | Samples |
| LMV934Q1MT/NOPB | ACTIVE | TSSOP | PW | 14 | 94 | Green (RoHS & no Sb/Br) | CU SN | Level-1-260C-UNLIM | -40 to 125 | LMV934 Q1MT | Samples |
| LMV934Q1MTX/NOPB | ACTIVE | TSSOP | PW | 14 | 2500 | Green (RoHS & no Sb/Br) | CU SN | Level-1-260C-UNLIM | -40 to 125 | LMV934 Q1MT | Samples |

(1) The marketing status values are defined as follows:

ACTIVE: Product device recommended for new designs.

LIFEBUY: TI has announced that the device will be discontinued, and a lifetime-buy period is in effect.

NRND: Not recommended for new designs. Device is in production to support existing customers, but TI does not recommend using this part in a new design.

PREVIEW: Device has been announced but is not in production. Samples may or may not be available.

OBsolete: TI has discontinued the production of the device.

(2) **RoHS:** TI defines "RoHS" to mean semiconductor products that are compliant with the current EU RoHS requirements for all 10 RoHS substances, including the requirement that RoHS substance do not exceed 0.1% by weight in homogeneous materials. Where designed to be soldered at high temperatures, "RoHS" products are suitable for use in specified lead-free processes. TI may reference these types of products as "Pb-Free".

RoHS Exempt: TI defines "RoHS Exempt" to mean products that contain lead but are compliant with EU RoHS pursuant to a specific EU RoHS exemption.

Green: TI defines "Green" to mean the content of Chlorine (Cl) and Bromine (Br) based flame retardants meet JS709B low halogen requirements of <=100ppm threshold. Antimony trioxide based flame retardants must also meet the <=1000ppm threshold requirement.

(3) MSL, Peak Temp. - The Moisture Sensitivity Level rating according to the JEDEC industry standard classifications, and peak solder temperature.

(4) There may be additional marking, which relates to the logo, the lot trace code information, or the environmental category on the device.

(5) Multiple Device Markings will be inside parentheses. Only one Device Marking contained in parentheses and separated by a "-" will appear on a device. If a line is indented then it is a continuation of the previous line and the two combined represent the entire Device Marking for that device.

(6) Lead/Ball Finish - Orderable Devices may have multiple material finish options. Finish options are separated by a vertical ruled line. Lead/Ball Finish values may wrap to two lines if the finish value exceeds the maximum column width.

Important Information and Disclaimer:The information provided on this page represents TI's knowledge and belief as of the date that it is provided. TI bases its knowledge and belief on information provided by third parties, and makes no representation or warranty as to the accuracy of such information. Efforts are underway to better integrate information from third parties. TI has taken and continues to take reasonable steps to provide representative and accurate information but may not have conducted destructive testing or chemical analysis on incoming materials and chemicals. TI and TI suppliers consider certain information to be proprietary, and thus CAS numbers and other limited information may not be available for release.

In no event shall TI's liability arising out of such information exceed the total purchase price of the TI part(s) at issue in this document sold by TI to Customer on an annual basis.

OTHER QUALIFIED VERSIONS OF LMV931-N-Q1, LMV932-N-Q1, LMV934-N-Q1 :

- Catalog: [LMV931-N](#), [LMV932-N](#), [LMV934-N](#)

NOTE: Qualified Version Definitions:

- Catalog - TI's standard catalog product

TAPE AND REEL INFORMATION



QUADRANT ASSIGNMENTS FOR PIN 1 ORIENTATION IN TAPE



*All dimensions are nominal

| Device | Package Type | Package Drawing | Pins | SPQ | Reel Diameter (mm) | Reel Width W1 (mm) | A0 (mm) | B0 (mm) | K0 (mm) | P1 (mm) | W (mm) | Pin1 Quadrant |
|------------------|--------------|-----------------|------|------|--------------------|--------------------|---------|---------|---------|---------|--------|---------------|
| LMV931Q1MF/NOPB | SOT-23 | DBV | 5 | 1000 | 178.0 | 8.4 | 3.2 | 3.2 | 1.4 | 4.0 | 8.0 | Q3 |
| LMV931Q1MFX/NOPB | SOT-23 | DBV | 5 | 3000 | 178.0 | 8.4 | 3.2 | 3.2 | 1.4 | 4.0 | 8.0 | Q3 |
| LMV931Q1MG/NOPB | SC70 | DCK | 5 | 1000 | 178.0 | 8.4 | 2.25 | 2.45 | 1.2 | 4.0 | 8.0 | Q3 |
| LMV931Q1MGX/NOPB | SC70 | DCK | 5 | 3000 | 178.0 | 8.4 | 2.25 | 2.45 | 1.2 | 4.0 | 8.0 | Q3 |
| LMV932Q1MAX/NOPB | SOIC | D | 8 | 2500 | 330.0 | 12.4 | 6.5 | 5.4 | 2.0 | 8.0 | 12.0 | Q1 |
| LMV934Q1MTX/NOPB | TSSOP | PW | 14 | 2500 | 330.0 | 12.4 | 6.95 | 5.6 | 1.6 | 8.0 | 12.0 | Q1 |

TAPE AND REEL BOX DIMENSIONS

*All dimensions are nominal

| Device | Package Type | Package Drawing | Pins | SPQ | Length (mm) | Width (mm) | Height (mm) |
|------------------|--------------|-----------------|------|------|-------------|------------|-------------|
| LMV931Q1MF/NOPB | SOT-23 | DBV | 5 | 1000 | 210.0 | 185.0 | 35.0 |
| LMV931Q1MFX/NOPB | SOT-23 | DBV | 5 | 3000 | 210.0 | 185.0 | 35.0 |
| LMV931Q1MG/NOPB | SC70 | DCK | 5 | 1000 | 210.0 | 185.0 | 35.0 |
| LMV931Q1MGX/NOPB | SC70 | DCK | 5 | 3000 | 210.0 | 185.0 | 35.0 |
| LMV932Q1MAX/NOPB | SOIC | D | 8 | 2500 | 367.0 | 367.0 | 35.0 |
| LMV934Q1MTX/NOPB | TSSOP | PW | 14 | 2500 | 367.0 | 367.0 | 35.0 |

DCK (R-PDSO-G5)

PLASTIC SMALL-OUTLINE PACKAGE



- NOTES:
- A. All linear dimensions are in millimeters.
 - B. This drawing is subject to change without notice.
 - C. Body dimensions do not include mold flash or protrusion. Mold flash and protrusion shall not exceed 0.15 per side.
 - D. Falls within JEDEC MO-203 variation AA.

DCK (R-PDSO-G5)

PLASTIC SMALL OUTLINE

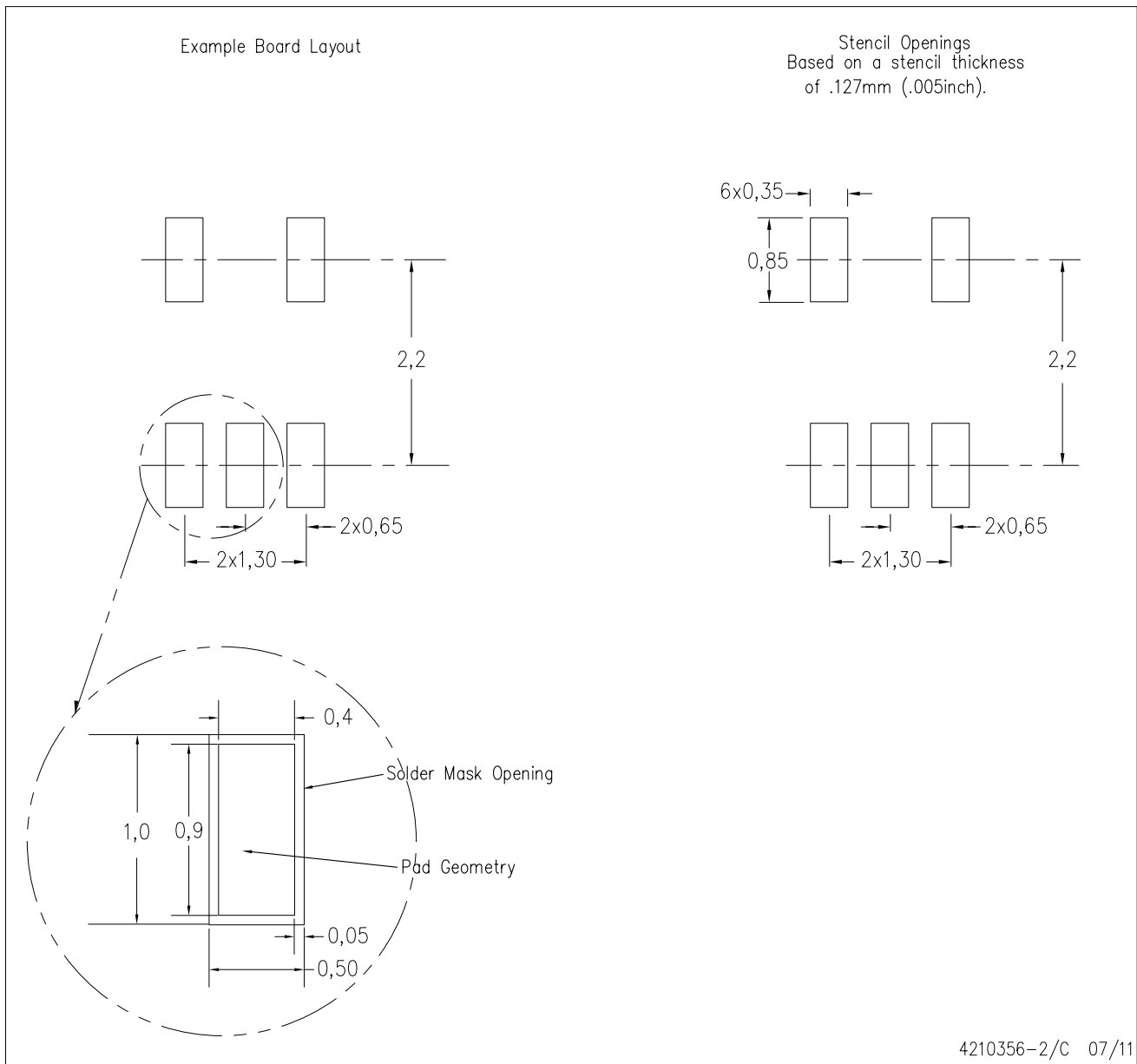

- NOTES:
- All linear dimensions are in millimeters.
 - This drawing is subject to change without notice.
 - Customers should place a note on the circuit board fabrication drawing not to alter the center solder mask defined pad.
 - Publication IPC-7351 is recommended for alternate designs.
 - Laser cutting apertures with trapezoidal walls and also rounding corners will offer better paste release. Customers should contact their board assembly site for stencil design recommendations. Example stencil design based on a 50% volumetric metal load solder paste. Refer to IPC-7525 for other stencil recommendations.

PW (R-PDSO-G14)

PLASTIC SMALL OUTLINE



- NOTES:
- All linear dimensions are in millimeters.
 - This drawing is subject to change without notice.
 - Publication IPC-7351 is recommended for alternate designs.
 - Laser cutting apertures with trapezoidal walls and also rounding corners will offer better paste release. Customers should contact their board assembly site for stencil design recommendations. Refer to IPC-7525 for other stencil recommendations.
 - Customers should contact their board fabrication site for solder mask tolerances between and around signal pads.



D0008A

PACKAGE OUTLINE

SOIC - 1.75 mm max height

SMALL OUTLINE INTEGRATED CIRCUIT



4214825/C 02/2019

NOTES:

- Linear dimensions are in inches [millimeters]. Dimensions in parenthesis are for reference only. Controlling dimensions are in inches. Dimensioning and tolerancing per ASME Y14.5M.
- This drawing is subject to change without notice.
- This dimension does not include mold flash, protrusions, or gate burrs. Mold flash, protrusions, or gate burrs shall not exceed $.006$ [0.15] per side.
- This dimension does not include interlead flash.
- Reference JEDEC registration MS-012, variation AA.

EXAMPLE BOARD LAYOUT

D0008A

SOIC - 1.75 mm max height

SMALL OUTLINE INTEGRATED CIRCUIT



LAND PATTERN EXAMPLE
 EXPOSED METAL SHOWN
 SCALE:8X



SOLDER MASK DETAILS

4214825/C 02/2019

NOTES: (continued)

- 6. Publication IPC-7351 may have alternate designs.
- 7. Solder mask tolerances between and around signal pads can vary based on board fabrication site.

EXAMPLE STENCIL DESIGN

D0008A

SOIC - 1.75 mm max height

SMALL OUTLINE INTEGRATED CIRCUIT



SOLDER PASTE EXAMPLE
BASED ON .005 INCH [0.125 MM] THICK STENCIL
SCALE:8X

4214825/C 02/2019

NOTES: (continued)

8. Laser cutting apertures with trapezoidal walls and rounded corners may offer better paste release. IPC-7525 may have alternate design recommendations.
9. Board assembly site may have different recommendations for stencil design.

EXAMPLE BOARD LAYOUT

DBV0005A

SOT-23 - 1.45 mm max height

SMALL OUTLINE TRANSISTOR



LAND PATTERN EXAMPLE
EXPOSED METAL SHOWN
SCALE:15X



SOLDER MASK DETAILS

4214839/D 11/2018

NOTES: (continued)

- 5. Publication IPC-7351 may have alternate designs.
- 6. Solder mask tolerances between and around signal pads can vary based on board fabrication site.

EXAMPLE STENCIL DESIGN

DBV0005A

SOT-23 - 1.45 mm max height

SMALL OUTLINE TRANSISTOR



SOLDER PASTE EXAMPLE
BASED ON 0.125 mm THICK STENCIL
SCALE:15X

4214839/D 11/2018

NOTES: (continued)

7. Laser cutting apertures with trapezoidal walls and rounded corners may offer better paste release. IPC-7525 may have alternate design recommendations.
8. Board assembly site may have different recommendations for stencil design.

IMPORTANT NOTICE AND DISCLAIMER

TI PROVIDES TECHNICAL AND RELIABILITY DATA (INCLUDING DATASHEETS), DESIGN RESOURCES (INCLUDING REFERENCE DESIGNS), APPLICATION OR OTHER DESIGN ADVICE, WEB TOOLS, SAFETY INFORMATION, AND OTHER RESOURCES "AS IS" AND WITH ALL FAULTS, AND DISCLAIMS ALL WARRANTIES, EXPRESS AND IMPLIED, INCLUDING WITHOUT LIMITATION ANY IMPLIED WARRANTIES OF MERCHANTABILITY, FITNESS FOR A PARTICULAR PURPOSE OR NON-INFRINGEMENT OF THIRD PARTY INTELLECTUAL PROPERTY RIGHTS.

These resources are intended for skilled developers designing with TI products. You are solely responsible for (1) selecting the appropriate TI products for your application, (2) designing, validating and testing your application, and (3) ensuring your application meets applicable standards, and any other safety, security, or other requirements. These resources are subject to change without notice. TI grants you permission to use these resources only for development of an application that uses the TI products described in the resource. Other reproduction and display of these resources is prohibited. No license is granted to any other TI intellectual property right or to any third party intellectual property right. TI disclaims responsibility for, and you will fully indemnify TI and its representatives against, any claims, damages, costs, losses, and liabilities arising out of your use of these resources.

TI's products are provided subject to TI's Terms of Sale (www.ti.com/legal/termsofsale.html) or other applicable terms available either on ti.com or provided in conjunction with such TI products. TI's provision of these resources does not expand or otherwise alter TI's applicable warranties or warranty disclaimers for TI products.

Mailing Address: Texas Instruments, Post Office Box 655303, Dallas, Texas 75265
Copyright © 2019, Texas Instruments Incorporated

Looking for pricing, stock, or lifecycle information?

Click below to explore more details on WIN SOURCE:

 [View LMV931Q1MFX/NOPB on WIN SOURCE](#)

 [Texas Instruments](#) Information

Optimize Your Supply Chain with WIN SOURCE Solutions

-  Global Sourcing Solution
-  Obsolete Management
-  Cost Control Management
-  Shortage Management
-  Alternative Solution
-  Excess Inventory Management