



**THE DATASHEET OF
LP5904TME-1.2/NOPB**



Ultra Low Noise, 200 mA Linear Regulator for RF/Analog Circuits - Requires No Bypass Capacitor

Check for Samples: [LP5904](#)

FEATURES

- Stable with 1.0 μF Ceramic Input and Output Capacitors
- No Noise Bypass Capacitor Required
- Remote Output Capacitor Placement
- Thermal-overload and Short-circuit Protection
- -40°C to $+125^{\circ}\text{C}$ Junction Temperature Range for Operation

APPLICATIONS

- Cellular Phones
- PDA Handsets
- Wireless LAN Devices

KEY SPECIFICATIONS

- Input Voltage Range ... 2.2V to 5.5V
- Output Voltage Range ... 1.2V to 4.4V
- Output Current ... 200 mA
- Low Output Voltage Noise at 200 mA ... 6.5 μVRMS
- PSRR ... 78 dB at 1kHz
- Output Voltage Tolerance ... $\pm 2\%$
- Virtually Zero IQ (Disabled) ... $<1 \mu\text{A}$
- Very Low IQ (Enabled) ... 11 μA
- Startup Time ... 85 μs
- Low Dropout ... 95 mV typ

TYPICAL APPLICATION CIRCUIT

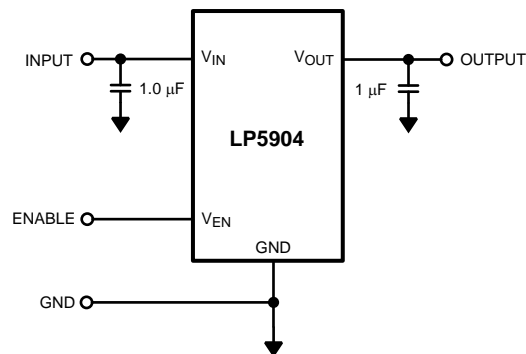

SVA-30110401



Please be aware that an important notice concerning availability, standard warranty, and use in critical applications of Texas Instruments semiconductor products and disclaimers thereto appears at the end of this data sheet.

PACKAGE

- 4-Bump DSBGA (lead free)
0.815 mm × 0.815 mm × 0.600 mm

DESCRIPTION

The LP5904 is a linear regulator capable of supplying 200 mA output current. Designed to meet the requirements of RF/ Analog circuits, the LP5904 device provides low noise, high PSRR, low quiescent current, and low line transient response figures. Using new innovative design techniques the LP5904 offers class-leading device noise performance without a noise bypass capacitor and the ability for remote output capacitor placement. An active pulldown circuit with a 280 Ω resistor is wired from the output to ground pins to quickly discharge output when the device is disabled ($V_{\text{EN}} = \text{low}$).

The device is designed to work with a 1.0 μF input and a 1.0 μF output ceramic capacitor. (No Bypass Capacitor is required.)

The device is available in a DSBGA package. For other package options contact your local TI sales office.

This device is available between 1.2V and 4.4V in 25 mV steps. Please contact Texas Instruments Sales for specific voltage option needs.



These devices have limited built-in ESD protection. The leads should be shorted together or the device placed in conductive foam during storage or handling to prevent electrostatic damage to the MOS gates.

CONNECTION DIAGRAMS

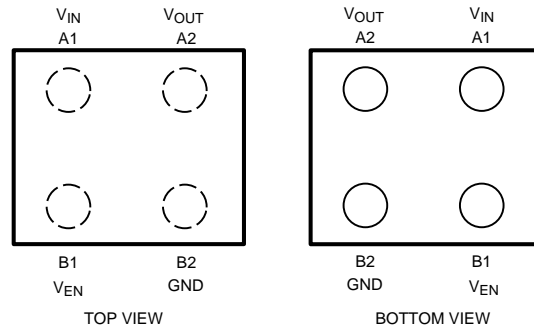

SVA-30110402

Note: The actual physical placement of the package marking will vary from part to part. The package marking “A” designates the date code, and will vary in production.

**Figure 1. 4-Bump Thin DSBGA Package
Package Number YFQ0004AAA**

PIN DESCRIPTIONS

PIN		DESCRIPTION
NAME	NO.	
A1	VIN	Input voltage supply. A 1.0 μ F capacitor should be connected at this input.
A2	VOUT	Output voltage. A 1.0 μ F Low ESR capacitor should be connected to this pin. Connect this output to the load circuit. An internal 280 Ω discharge resistor prevents a charge remaining on V _{OUT} when disabled.
B1	VEN	Enable input; disables the regulator when ≤ 0.4 V. Enables the regulator when ≥ 1.2 V. An internal 1M Ω pulldown resistor connects this input to ground.
B2	GND	Common ground.

ORDERING INFORMATION

DSBGA PACKAGE (LEAD FREE) ⁽¹⁾		
OUTPUT VOLTAGE (V)	SUPPLIED AS	
	250 TAPE AND REEL	3000 TAPE AND REEL
1.2	LP5904TME-1.2/NOPB	LP5904TMX-1.2/NOPB
1.8 ⁽²⁾	LP5904TME-1.8/NOPB	LP5904TMX-1.8/NOPB
2.5 ⁽²⁾	LP5904TME-2.5/NOPB	LP5904TMX-2.5/NOPB
2.6 ⁽²⁾	LP5904TME-2.6/NOPB	LP5904TMX-2.6/NOPB
2.8	LP5904TME-2.8/NOPB	LP5904TMX-2.8/NOPB
2.85	LP5904TME-2.85/NOPB	LP5904TMX-2.85/NOPB
3.0 ⁽²⁾	LP5904TME-3.0/NOPB	LP5904TMX-3.0/NOPB
3.1	LP5904TME-3.1/NOPB	LP5904TMX-3.1/NOPB
3.2 ⁽²⁾	LP5904TME-3.2/NOPB	LP5904TMX-3.2/NOPB
3.4 ⁽²⁾	LP5904TME-3.4/NOPB	LP5904TMX-3.4/NOPB

(1) Contact your local TI Sales Office for availability of other voltage options.

(2) Not yet released — contact TI sales office for sample availability.

ABSOLUTE MAXIMUM RATINGS⁽¹⁾⁽²⁾⁽³⁾

over operating free-air temperature range (unless otherwise noted)

		MIN	MAX	UNIT
V _{IN}	Input Voltage	-0.3	6.0	V
V _{OUT}	Output Voltage	-0.3 to (V _{IN} + 0.3V)	6.0	V
V _{EN}	Enable Input Voltage	-0.3 to (V _{IN} + 0.3V)	6.0	V
Continuous Power Dissipation ⁽⁴⁾		Internally Limited		
Junction Temperature (T _{JMAX})			150	°C
Storage Temperature Range		-65	150	°C
Maximum Lead Temperature (Soldering, 10 sec.)			260	°C
ESD Rating ⁽⁵⁾	Human Body Model		2	kV
	Machine Model		200	V

- (1) If Military/Aerospace specified devices are required, please contact the Texas Instruments Sales Office/ Distributors for availability and specifications.
- (2) Absolute Maximum Ratings indicate limits beyond which damage to the component may occur. Operating Ratings are conditions under which operation of the device is specified. Operating Ratings do not imply specified performance limits. For specified performance limits and associated test conditions, see the Electrical Characteristics tables.
- (3) All voltages are with respect to the potential at the GND pin.
- (4) Internal thermal shutdown circuitry protects the device from permanent damage.
- (5) The Human body model is a 100 pF capacitor discharged through a 1.5 kΩ resistor into each pin. The machine model is a 200 pF capacitor discharged directly into each pin. MIL-STD-883 3015.7

OPERATING RATINGS⁽¹⁾⁽²⁾

over operating free-air temperature range (unless otherwise noted)

		MIN	NOM	MAX	UNIT
V _{IN}	Input Voltage Range	2.2		5.5	V
V _{EN}	Enable Voltage Range	0 to (V _{IN} + 0.3)		5.5	V
Recommended Load Current ⁽³⁾		0		200	mA
T _J	Junction Temperature Range	-40		+125	°C
T _A	Ambient Temperature Range ⁽³⁾	-40		+85	°C

- (1) Absolute Maximum Ratings indicate limits beyond which damage to the component may occur. Operating Ratings are conditions under which operation of the device is specified. Operating Ratings do not imply specified performance limits. For specified performance limits and associated test conditions, see the Electrical Characteristics tables.
- (2) All voltages are with respect to the potential at the GND pin.
- (3) In applications where high power dissipation and/or poor package thermal resistance is present, the maximum ambient temperature may have to be derated. Maximum ambient temperature (T_{A-MAX}) is dependent on the maximum operating junction temperature (T_{J-MAX-OP} = 125°C), the maximum power dissipation of the device in the application (P_{D-MAX}), and the junction-to ambient thermal resistance of the part/package in the application (θ_{JA}), as given by the following equation: T_{A-MAX} = T_{J-MAX-OP} - (θ_{JA} × P_{D-MAX}). See [applications](#) section.

THERMAL CHARACTERISTICS

over operating free-air temperature range (unless otherwise noted)

PARAMETER		TEST CONDITIONS		MIN	TYP	MAX	UNIT
θ _{JA}	Junction to Ambient Thermal Resistance ⁽¹⁾	JEDEC Board (DSBGA) ⁽²⁾				119.6	°C/W
		4L Cellphone Board (DSBGA)				186.5	°C/W

- (1) Junction-to-ambient thermal resistance is highly application and board-layout dependent. In applications where high maximum power dissipation exists, special care must be paid to thermal dissipation issues in board design.
- (2) Detailed description of the board can be found in JESD51-7

ELECTRICAL CHARACTERISTICS⁽¹⁾⁽²⁾

Limits in standard typeface are for $T_A = 25^\circ\text{C}$. Limits in boldface type apply over the full operating junction temperature range ($-40^\circ\text{C} \leq T_J \leq +125^\circ\text{C}$). Unless otherwise noted, specifications apply to the LP5904 [Typical Application Circuit](#) with: $V_{IN} = V_{OUT(NOM)} + 1.0\text{V}$, $V_{EN} = 1.2\text{V}$, $C_{IN} = 1.0\ \mu\text{F}$, $C_{OUT} = 1.0\ \mu\text{F}$, $I_{OUT} = 1.0\ \text{mA}$.

PARAMETER		TEST CONDITIONS	MIN	TYP	MAX	UNIT
V_{IN}	Input Voltage		2.2		5.5	V
ΔV_{OUT}	Output Voltage Tolerance	$V_{IN} = (V_{OUT(NOM)} + 1.0\text{V})$ to 5.5V, $I_{OUT} = 1\text{mA}$ to 200 mA	-2		2	%
	Line Regulation	$V_{IN} = (V_{OUT(NOM)} + 1.0\text{V})$ to 5.0V, $I_{OUT} = 1\ \text{mA}$		0.06		%V
		$V_{IN} = (V_{OUT(NOM)} + 1.0\text{V})$ to 5.5V, $I_{OUT} = 1\ \text{mA}$		0.16		
	Load Regulation	$I_{OUT} = 1\text{mA}$ to 200 mA		0.002		%/mA
I_{LOAD}	Load Current	See ⁽³⁾	0		200	mA
	Maximum Output Current		200			
I_Q	Quiescent Current ⁽⁴⁾	$V_{EN} = 1.2\text{V}$, $I_{OUT} = 0\ \text{mA}$		11	20	μA
		$V_{EN} = 1.2\text{V}$, $I_{OUT} = 200\ \text{mA}$		250	325	
		$V_{EN} = 0.3\text{V}$ (Disabled)		0.2	1.0	
I_G	Ground Current ⁽⁵⁾	$I_{OUT} = 0\ \text{mA}$ ($V_{EN} = 1.2\text{V}$)		12.2		μA
V_{DO}	Dropout Voltage ⁽⁶⁾	$I_{OUT} = 100\ \text{mA}$		45		mV
		$I_{OUT} = 200\ \text{mA}$		95	150	
I_{SC}	Short Circuit Current Limit	See ⁽⁷⁾	220	450		mA
PSRR	Power Supply Rejection Ratio ⁽⁸⁾	$f = 100\ \text{Hz}$, $I_{OUT} = 10\ \text{mA}$		88		dB
		$f = 1\ \text{kHz}$, $I_{OUT} = 10\ \text{mA}$		80		
		$f = 10\ \text{kHz}$, $I_{OUT} = 10\ \text{mA}$		70		
		$f = 100\ \text{kHz}$, $I_{OUT} = 10\ \text{mA}$		50		
		$f = 2\ \text{MHz}$, $I_{OUT} = 10\ \text{mA}$		30		
e_N	Output Noise Voltage ⁽⁸⁾	BW = 10 Hz to 100 kHz	$I_{OUT} = 1\text{mA}$		10	μV_{RMS}
			$I_{OUT} = 200\ \text{mA}$		6.5	
$T_{SHUTDOWN}$	Thermal Shutdown	Temperature		160		$^\circ\text{C}$
		Hysteresis		15		
LOGIN INPUT THRESHOLDS						
V_{IL}	Low Input Threshold (V_{EN})	$V_{IN} = 2.2\text{V}$ to 5.5V			0.4	V
V_{IH}	High Input Threshold (V_{EN})	$V_{IN} = 2.2\text{V}$ to 5.5V		1.2		V
I_{EN}	Input Current at V_{EN} Pin ⁽⁹⁾	$V_{EN} = 5.5\text{V}$ and $V_{IN} = 5.5\text{V}$		5.5		μA
		$V_{EN} = 0.0\text{V}$ and $V_{IN} = 5.5\text{V}$		0.001		

- (1) All voltages are with respect to the potential at the GND pin.
- (2) Min and Max limits are specified by design, test, or statistical analysis. Typical numbers are not specified, but do represent the most likely norm.
- (3) The device maintains a stable, regulated output voltage without a load current.
- (4) Quiescent current is defined here as the difference in current between the input voltage source and the load at V_{OUT} .
- (5) Ground current is defined here as the total current flowing to ground as a result of all input voltages applied to the device.
- (6) Dropout voltage is the voltage difference between the input and the output at which the output voltage drops to 100 mV below its nominal value. This specification does not apply for input voltages below 2.2V.
- (7) Short Circuit Current is measured with V_{OUT} pulled to 0V and V_{IN} worst case = 5.5V.
- (8) This specification is ensured by design.
- (9) There is a 1M Ω resistor between V_{EN} and ground on the device.

ELECTRICAL CHARACTERISTICS⁽¹⁾⁽²⁾ (continued)

Limits in standard typeface are for $T_A = 25^\circ\text{C}$. Limits in boldface type apply over the full operating junction temperature range ($-40^\circ\text{C} \leq T_J \leq +125^\circ\text{C}$). Unless otherwise noted, specifications apply to the LP5904 [Typical Application Circuit](#) with: $V_{IN} = V_{OUT(NOM)} + 1.0\text{V}$, $V_{EN} = 1.2\text{V}$, $C_{IN} = 1.0\ \mu\text{F}$, $C_{OUT} = 1.0\ \mu\text{F}$, $I_{OUT} = 1.0\ \text{mA}$.

PARAMETER		TEST CONDITIONS	MIN	TYP	MAX	UNIT
TRANSIENT CHARACTERISTICS						
ΔV_{OUT}	Line Transient ⁽¹⁰⁾	$V_{IN} = (V_{OUT(NOM)} + 1.0\text{V})$ to $(V_{OUT(NOM)} + 1.6\text{V})$ in $30\ \mu\text{s}$, $I_{OUT} = 1\text{mA}$	-2			mV
		$V_{IN} = (V_{OUT(NOM)} + 1.6\text{V})$ to $(V_{OUT(NOM)} + 1.0\text{V})$ in $30\ \mu\text{s}$, $I_{OUT} = 1\text{mA}$			2	
	Load Transient ⁽¹⁰⁾	$I_{OUT} = 1\text{mA}$ to $200\ \text{mA}$ in $10\ \mu\text{s}$	-50			mV
		$I_{OUT} = 200\ \text{mA}$ to 1mA in $10\ \mu\text{s}$			50	
	Overshoot on Startup ⁽¹⁰⁾	Stated as a percentage of nominal V_{OUT}			2	%
	Turn-on Time	To 95% of $V_{OUT(NOM)}$		85	300	μs

(10) This specification is ensured by design.

OUTPUT AND INPUT CAPACITORS

over operating free-air temperature range (unless otherwise noted)

PARAMETER		TEST CONDITIONS	MIN ⁽¹⁾	TYP	MAX	UNIT
C_{IN}	Input Capacitance ⁽²⁾	Capacitance for stability	0.5	1.0		μF
C_{OUT}	Output Capacitance ⁽²⁾		0.5	1.0	10	
ESR	Output/Input Capacitance ⁽²⁾		5		500	$\text{m}\Omega$

(1) Note: The minimum capacitance should be greater than $0.5\ \mu\text{F}$ over the full range of operating conditions. The capacitor tolerance should be 30% or better over the full temperature range. The full range of operating conditions for the capacitor in the application should be considered during device selection to ensure this minimum capacitance specification is met. X7R capacitors are recommended however capacitor types X5R, Y5V and Z5U may be used with consideration of the application and conditions.

(2) This specification is ensured by design.

BLOCK DIAGRAM

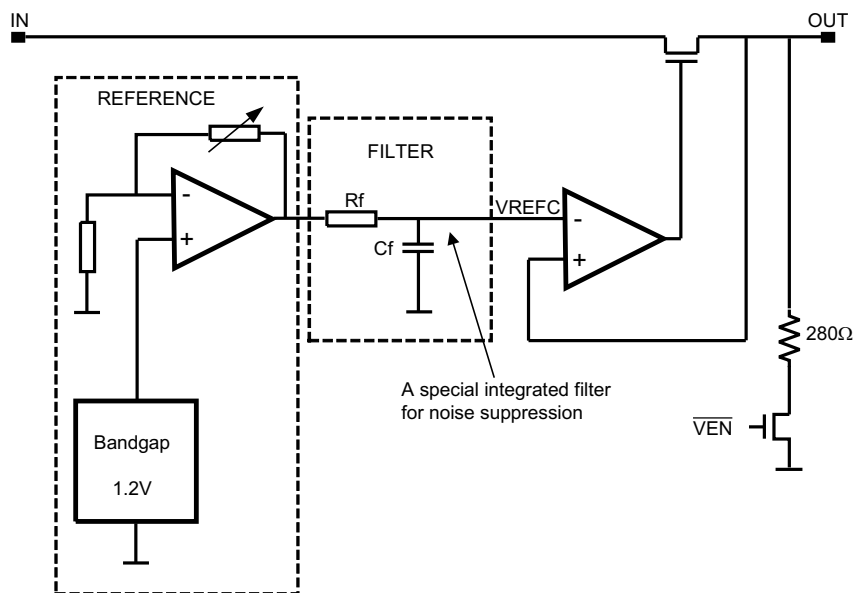

SVA-30110406

TYPICAL CHARACTERISTICS

Unless otherwise noted, $V_{OUT} = 2.8V$, $V_{IN} = 3.8V$, $E_N = 1.2V$, $C_{IN} = 1.0 \mu F$, $C_{OUT} = 1.0 \mu F$, $T_A = 25^\circ C$.

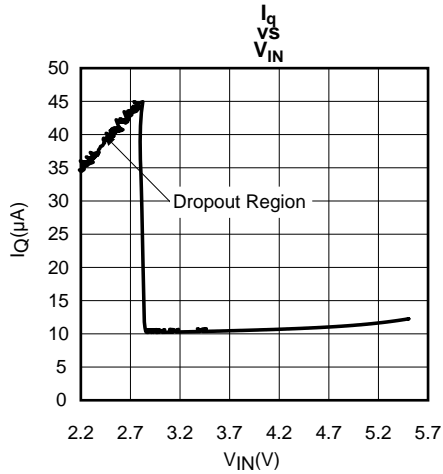

Figure 2.

SVA-30110460

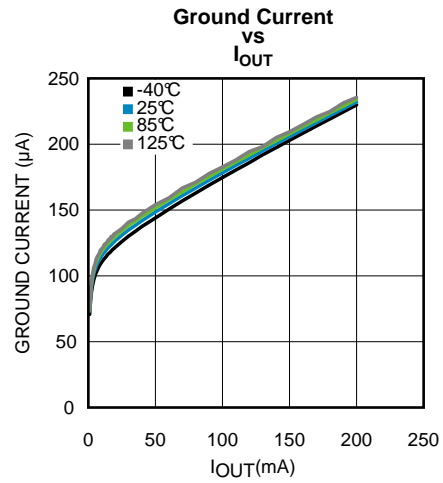

Figure 3.

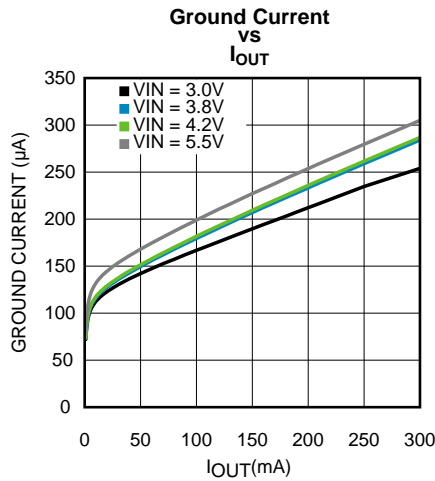

Figure 4.

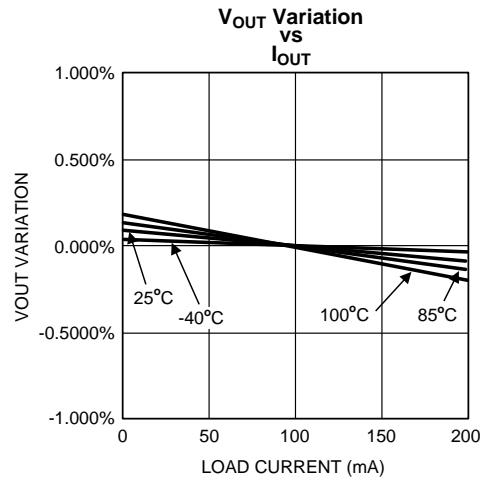

Figure 5.

SVA-30110403

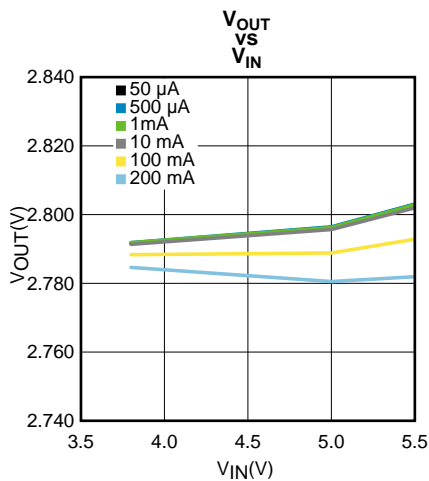

Figure 6.

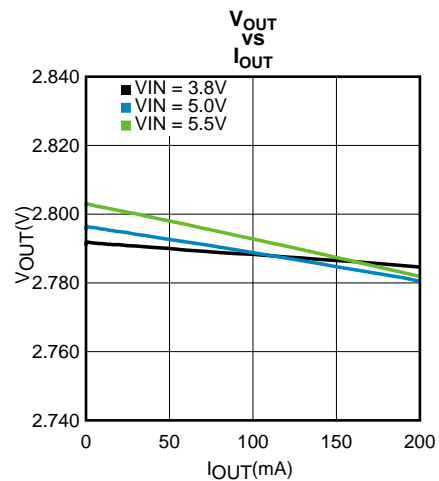

Figure 7.

TYPICAL CHARACTERISTICS (continued)

Unless otherwise noted, $V_{OUT} = 2.8V$, $V_{IN} = 3.8V$, $E_N = 1.2V$, $C_{IN} = 1.0 \mu F$, $C_{OUT} = 1.0 \mu F$, $T_A = 25^\circ C$.

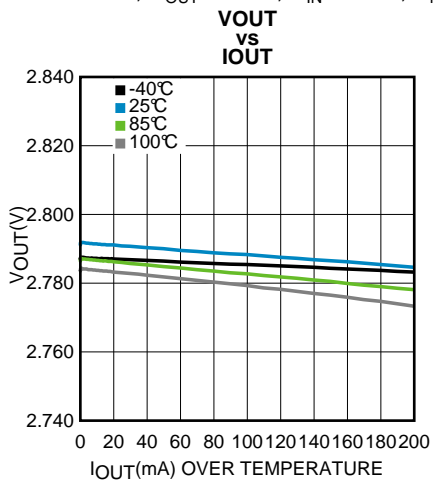
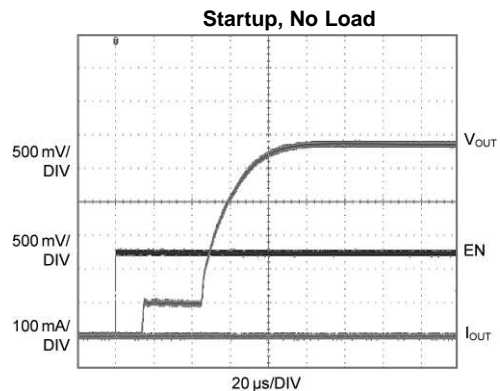
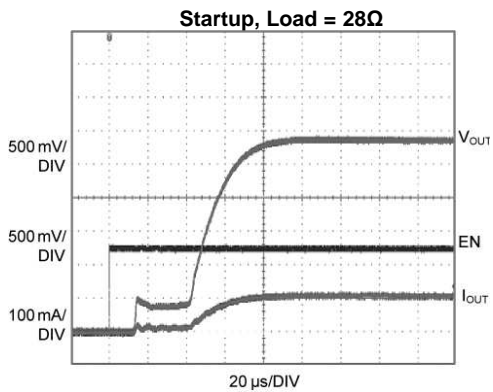

Figure 8.



SVA-30110442

Figure 9.



SVA-30110443

Figure 10.

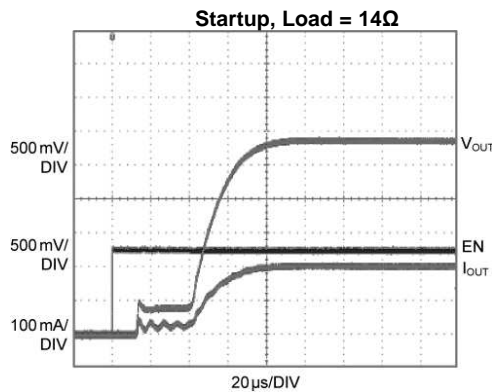

SVA-30110444

Figure 11.

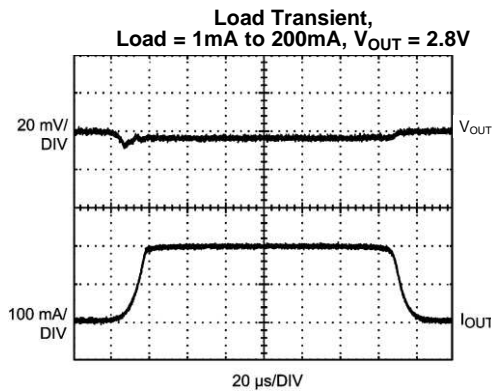

SVA-30110445

Figure 12.

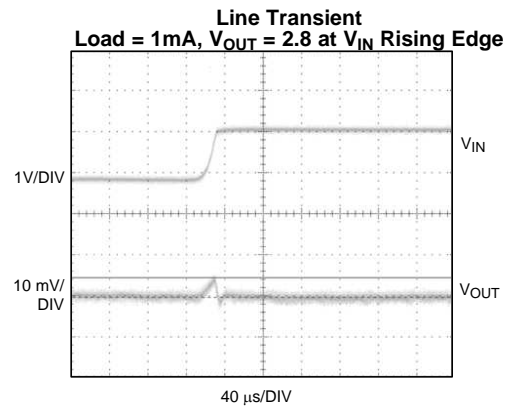

SVA-30110412

Figure 13.

TYPICAL CHARACTERISTICS (continued)

Unless otherwise noted, $V_{OUT} = 2.8V$, $V_{IN} = 3.8V$, $E_N = 1.2V$, $C_{IN} = 1.0 \mu F$, $C_{OUT} = 1.0 \mu F$, $T_A = 25^\circ C$.

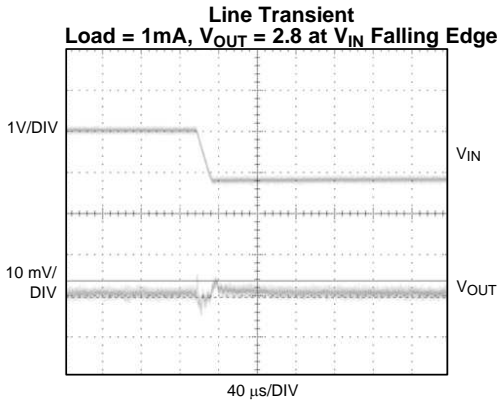

SVA-30110413

Figure 14.

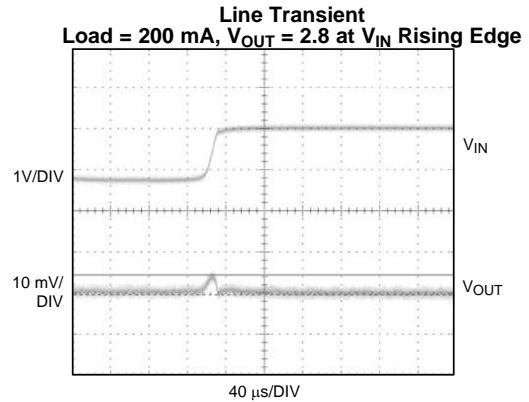

SVA-30110414

Figure 15.

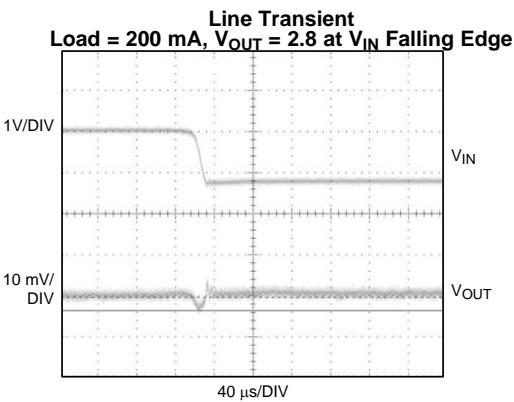

SVA-30110415

Figure 16.

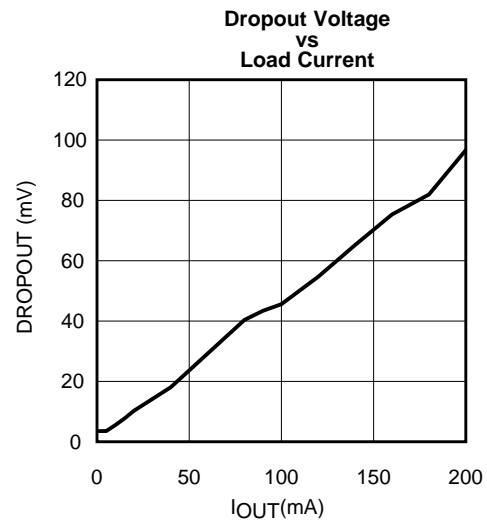

SVA-30110466

Figure 17.

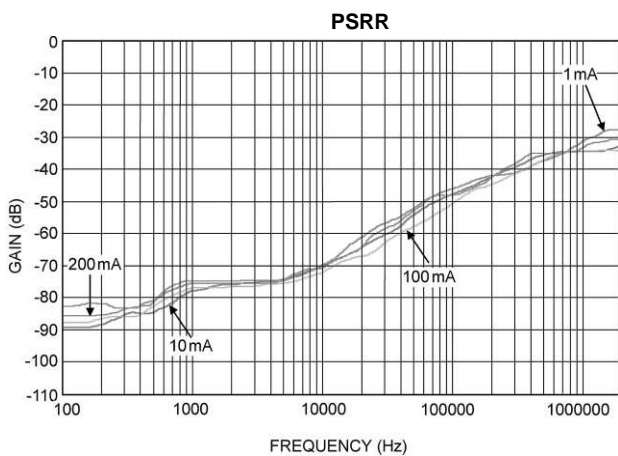

SVA-30110446

Figure 18.

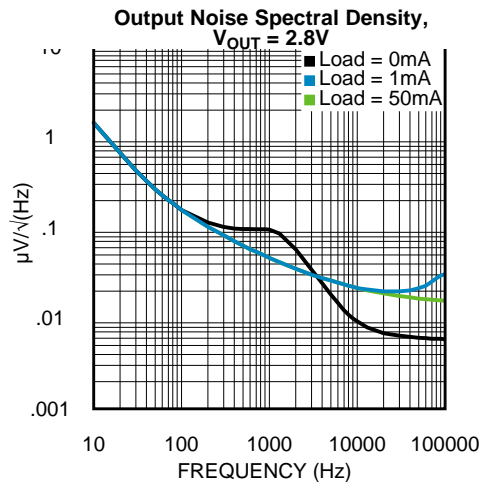

Figure 19.

TYPICAL CHARACTERISTICS (continued)

Unless otherwise noted, $V_{OUT} = 2.8V$, $V_{IN} = 3.8V$, $E_N = 1.2V$, $C_{IN} = 1.0 \mu F$, $C_{OUT} = 1.0 \mu F$, $T_A = 25^\circ C$.

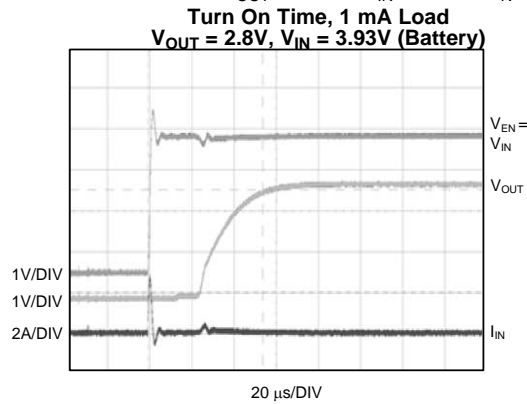

Figure 20.

SVA-30110416

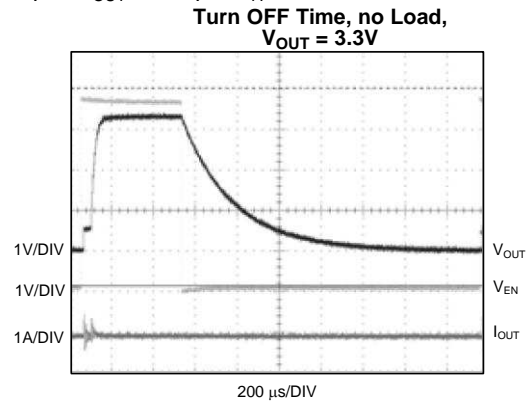

Figure 21.

SVA-30110418

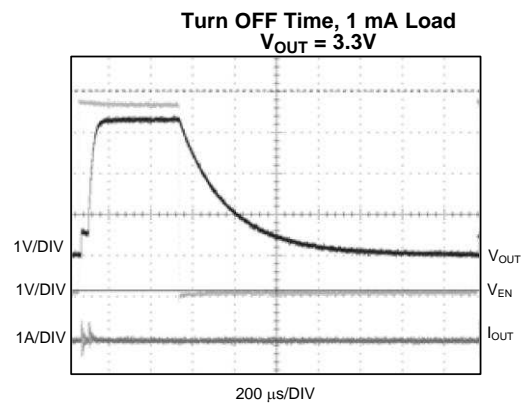

Figure 22.

SVA-30110419

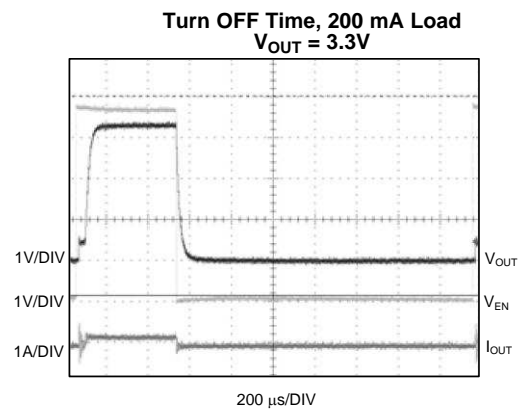

Figure 23.

SVA-30110420

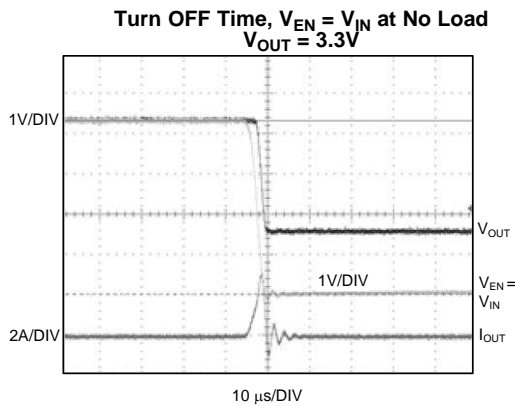

Figure 24.

SVA-30110421

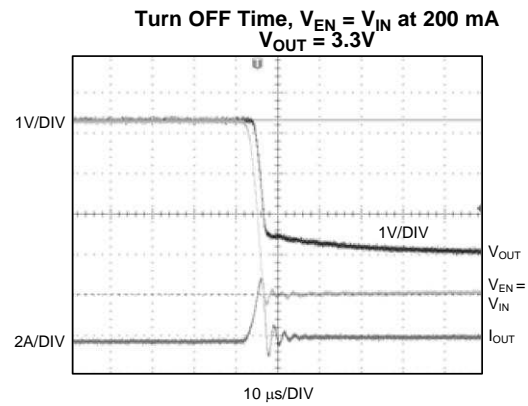

Figure 25.

SVA-30110422

TYPICAL CHARACTERISTICS (continued)

Unless otherwise noted, $V_{OUT} = 2.8V$, $V_{IN} = 3.8V$, $E_N = 1.2V$, $C_{IN} = 1.0 \mu F$, $C_{OUT} = 1.0 \mu F$, $T_A = 25^\circ C$.

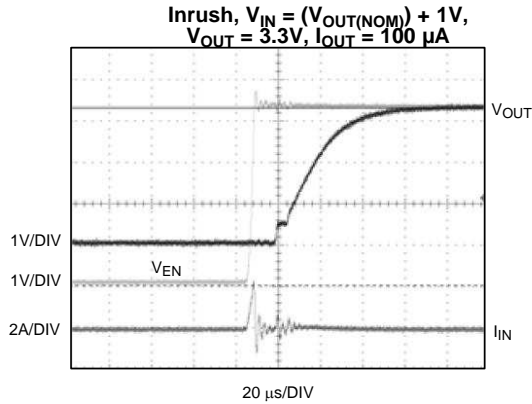

Figure 26.

SVA-30110423

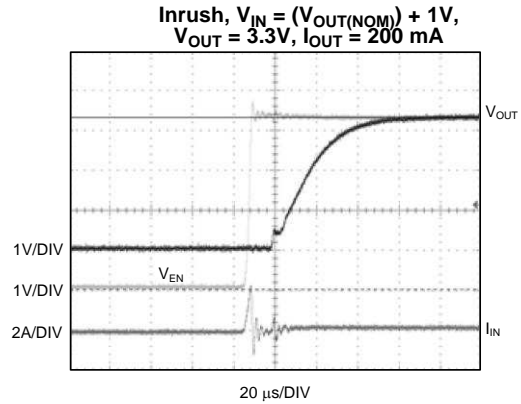

Figure 27.

SVA-30110424

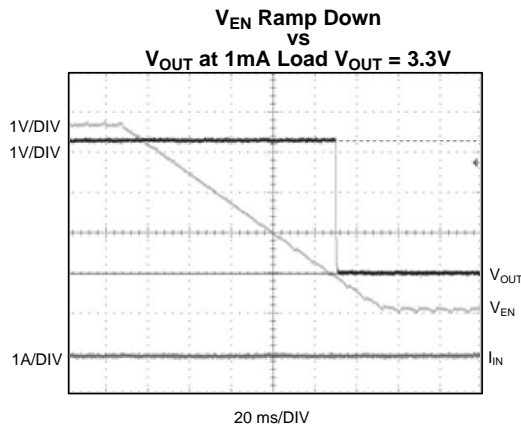

Figure 28.

SVA-30110425

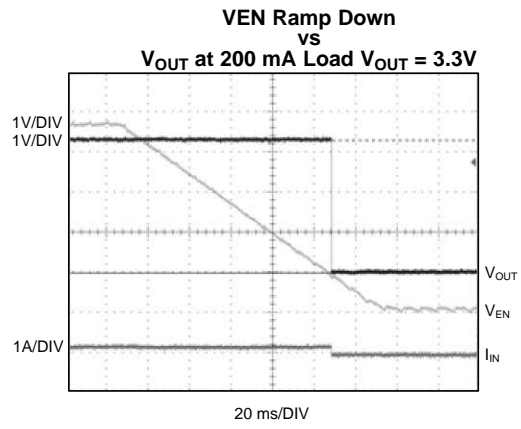

Figure 29.

SVA-30110426

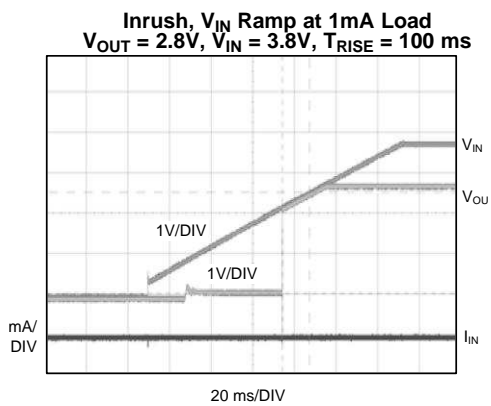

Figure 30.

SVA-30110417

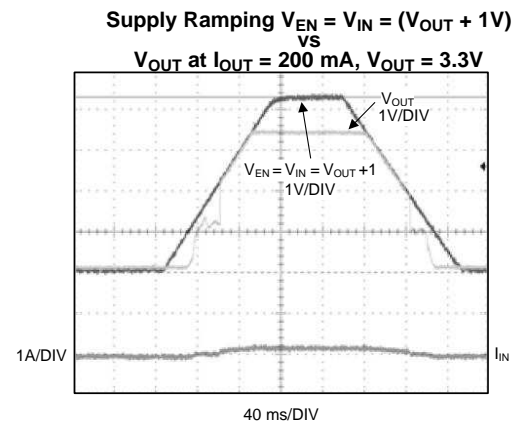

Figure 31.

SVA-30110427

TYPICAL CHARACTERISTICS (continued)

Unless otherwise noted, $V_{OUT} = 2.8V$, $V_{IN} = 3.8V$, $E_N = 1.2V$, $C_{IN} = 1.0 \mu F$, $C_{OUT} = 1.0 \mu F$, $T_A = 25^\circ C$.

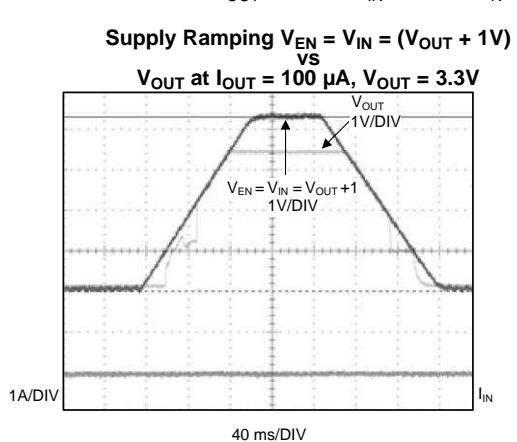

Figure 32.

SVA-30110428

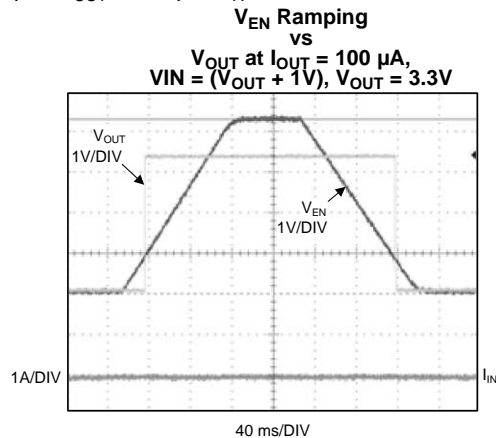

Figure 33.

SVA-30110429

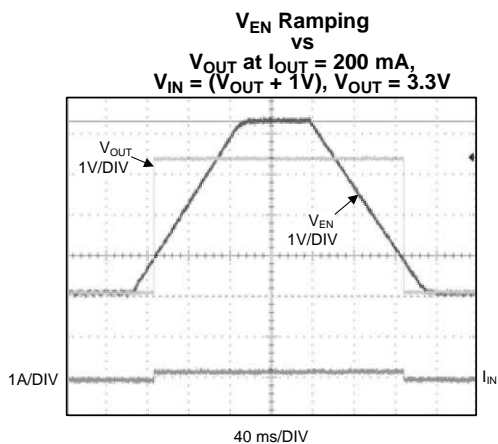

Figure 34.

SVA-30110430

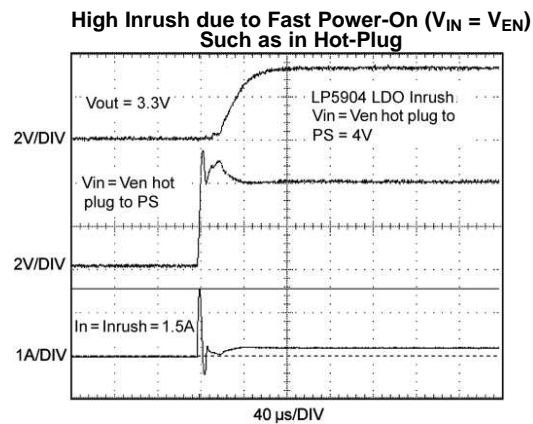

Figure 35.

SVA-30110405

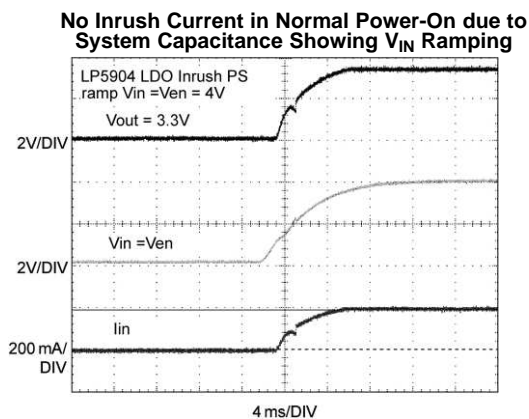

Figure 36.

SVA-30110409

APPLICATION INFORMATION

POWER DISSIPATION AND DEVICE OPERATION

The permissible power dissipation for any package is a measure of the capability of the device to pass heat from the power source, the junctions of the IC, to the ultimate heat sink, the ambient environment. Thus the power dissipation is dependent on the ambient temperature and the thermal resistance across the various interfaces between the die and ambient air. As stated in the [Operating Ratings](#) ⁽¹⁾, the allowable power dissipation for the device in a given package can be calculated using the equation:

$$P_D = \frac{(T_{JMAX} - T_A)}{\theta_{JA}} \quad (1)$$

The actual power dissipation across the device can be represented by the following equation:

$$P_D = (V_{IN} - V_{OUT}) \times I_{OUT} \quad (2)$$

This establishes the relationship between the power dissipation allowed due to thermal consideration, the voltage drop across the device, and the continuous current capability of the device. These two equations should be used to determine the optimum operating conditions for the device in the application.

EXTERNAL CAPACITORS

Like any low-dropout regulator, the LP5904 requires external capacitors for regulator stability. The LP5904 is specifically designed for portable applications requiring minimum board space and smallest components. These capacitors must be correctly selected for good performance.

INPUT CAPACITOR

An input capacitor is required for stability. The input capacitor should be at least equal to, or greater than, the output capacitor for good load transient performance. At least a 1.0 μ F capacitor has to be connected between the LP5904 input pin and ground for stable operation over full load current range. Basically, it is ok to have more output capacitance than input, as long as the input is at least 1.0 μ F.

This capacitor must be located a distance of not more than 1cm from the input pin and returned to a clean analog ground. Any good quality ceramic, tantalum, or film capacitor may be used at the input.

NOTE

Important: To ensure stable operation it is essential that good PCB practices are employed to minimize ground impedance and keep input inductance low. If these conditions cannot be met, or if long leads are to be used to connect the battery or other power source to the LP5904, then it is recommended to increase the input capacitor to at least 10 μ F. Also, tantalum capacitors can suffer catastrophic failures due to surge current when connected to a low-impedance source of power (like a battery or a very large capacitor). If a tantalum capacitor is used at the input, it must be specified by the manufacturer to have a surge current rating sufficient for the application. There are no requirements for the ESR (Equivalent Series Resistance) on the input capacitor, but tolerance and temperature coefficient must be considered when selecting the capacitor to ensure the capacitance will remain 1.0 μ F \pm 30% over the entire operating temperature range.

OUTPUT CAPACITOR

The LP5904 is designed specifically to work with a very small ceramic output capacitor, typically 1.0 μ F. A ceramic capacitor (dielectric types X5R or X7R) in the 0.5 μ F to 10 μ F range, and with ESR between 5m Ω to 500 m Ω , is suitable in the LP5904 application circuit. For this device the output capacitor should be connected between the V_{OUT} pin and a good ground connection.

(1) In applications where high power dissipation and/or poor package thermal resistance is present, the maximum ambient temperature may have to be derated. Maximum ambient temperature (T_{A-MAX}) is dependent on the maximum operating junction temperature ($T_{J-MAX-OP} = 125^\circ\text{C}$), the maximum power dissipation of the device in the application (P_{D-MAX}), and the junction-to ambient thermal resistance of the part/package in the application (θ_{JA}), as given by the following equation: $T_{A-MAX} = T_{J-MAX-OP} - (\theta_{JA} \times P_{D-MAX})$. See [APPLICATION INFORMATION](#).

It may also be possible to use tantalum or film capacitors at the device output, V_{OUT} , but these are not as attractive for reasons of size and cost (see [CAPACITOR CHARACTERISTICS](#) below).

The output capacitor must meet the requirement for the minimum value of capacitance and have an ESR value that is within the range 5m Ω to 500 m Ω for stability.

REMOTE CAPACITOR OPERATION

The LP5904 requires at least a 1 μ F capacitor at output pin, but there is no strict requirements about the location of the capacitor in regards the LDO output pin. In practical designs the output capacitor may be located some 5-10 cm away from the LDO. This means that there is no need to have a special capacitor close to the output pin if there is already respective capacitor(s) in the system (like a capacitor at the input of supplied part). The Remote Capacitor feature helps user to minimize the number of capacitors in the system.

As a good design practice, it is good to keep the wiring parasitic inductance at a minimum, which means to use as wide as possible traces from the LDO output to the capacitor(s), keeping the LDO trace layer as close as possible to ground layer and avoiding vias on the path. If there is a need to use vias, implement as many as possible vias between the connection layers. The recommendation is to keep parasitic wiring inductance less than 35 nH. For the applications with fast load transients, it is recommended to use an input capacitor equal to or larger to the sum of the capacitance at the output node for the best load transient performance.

CAPACITOR CHARACTERISTICS

The LP5904 is designed to work with ceramic capacitors on the input and output to take advantage of the benefits they offer. For capacitance values in the range of 0.5 μ F to 10 μ F, ceramic capacitors are the smallest, least expensive and have the lowest ESR values, thus making them best for eliminating high frequency noise. The ESR of a typical 1.0 μ F ceramic capacitor is in the range of 20 m Ω to 40 m Ω , which easily meets the ESR requirement for stability for the LP5904.

The temperature performance of ceramic capacitors varies by type and manufacturer. Most large value ceramic capacitors ($\geq 2.2 \mu$ F) are manufactured with Z5U or Y5V temperature characteristics, which results in the capacitance dropping by more than 50% as the temperature goes from 25°C to 85°C.

A better choice for temperature coefficient in a ceramic capacitor is X7R. This type of capacitor is the most stable and holds the capacitance within $\pm 15\%$ over the temperature range. Tantalum capacitors are less desirable than ceramic for use as output capacitors because they are more expensive when comparing equivalent capacitance and voltage ratings in the 0.5 μ F to 10 μ F range.

Another important consideration is that tantalum capacitors have higher ESR values than equivalent size ceramics. This means that while it may be possible to find a tantalum capacitor with an ESR value within the stable range, it would have to be larger in capacitance (which means bigger and more costly) than a ceramic capacitor with the same ESR value. It should also be noted that the ESR of a typical tantalum will increase about 2:1 as the temperature goes from 25°C down to -40°C, so some guard band must be allowed.

NO-LOAD STABILITY

The LP5904 will remain stable and in regulation with no external load.

ENABLE CONTROL

The LP5904 may be switched ON or OFF by a logic input at the ENABLE pin. A high voltage at this pin will turn the device on. When the enable pin is low, the regulator output is off and the device typically consumes 3nA. However, if the application does not require the shutdown feature, the V_{EN} pin can be tied to V_{IN} to keep the regulator output permanently on.

A 1M Ω pulldown resistor ties the V_{EN} input to ground, this ensures that the device will remain off when the enable pin is left open circuit. To ensure proper operation, the signal source used to drive the V_{EN} input must be able to swing above and below the specified turn-on/off voltage thresholds listed in the [Electrical Characteristics](#) section under V_{IL} and V_{IH} .

DSBGA MOUNTING

The DSBGA package requires specific mounting techniques, which are detailed in Texas Instruments Application Note AN-1112 ([SNVA009](#)).

For best results during assembly, alignment ordinals on the PC board may be used to facilitate placement of the DSBGA device.

DSBGA LIGHT SENSITIVITY

Exposing the DSBGA device to direct light may cause incorrect operation of the device. Light sources such as halogen lamps can affect electrical performance if they are situated in proximity to the device.

Light with wavelengths in the red and infrared part of the spectrum have the most detrimental effect; thus, the fluorescent lighting used inside most buildings has very little effect on performance.

REVISION HISTORY

Changes from Revision F (April 2013) to Revision G	Page
<hr/> <ul style="list-style-type: none">• Changed layout of National Data Sheet to TI format <hr/>	<hr/> 14 <hr/>

PACKAGING INFORMATION

Orderable Device	Status (1)	Package Type	Package Drawing	Pins	Package Qty	Eco Plan (2)	Lead/Ball Finish (6)	MSL Peak Temp (3)	Op Temp (°C)	Device Marking (4/5)	Samples
LP5904TME-1.2/NOPB	NRND	DSBGA	YFQ	4	250	Green (RoHS & no Sb/Br)	SNAGCU	Level-1-260C-UNLIM	-40 to 125		
LP5904TME-2.8/NOPB	ACTIVE	DSBGA	YFQ	4	250	Green (RoHS & no Sb/Br)	SNAGCU	Level-1-260C-UNLIM	-40 to 125		Samples
LP5904TME-2.85/NOPB	ACTIVE	DSBGA	YFQ	4	250	Green (RoHS & no Sb/Br)	SNAGCU	Level-1-260C-UNLIM	-40 to 125		Samples
LP5904TME-3.1/NOPB	ACTIVE	DSBGA	YFQ	4	250	Green (RoHS & no Sb/Br)	SNAGCU	Level-1-260C-UNLIM	-40 to 125		Samples
LP5904TMX-1.2/NOPB	NRND	DSBGA	YFQ	4	3000	Green (RoHS & no Sb/Br)	SNAGCU	Level-1-260C-UNLIM	-40 to 125		
LP5904TMX-2.8/NOPB	NRND	DSBGA	YFQ	4	3000	Green (RoHS & no Sb/Br)	SNAGCU	Level-1-260C-UNLIM	-40 to 125		
LP5904TMX-2.85/NOPB	NRND	DSBGA	YFQ	4	3000	Green (RoHS & no Sb/Br)	SNAGCU	Level-1-260C-UNLIM	-40 to 125		
LP5904TMX-3.1/NOPB	NRND	DSBGA	YFQ	4	3000	Green (RoHS & no Sb/Br)	SNAGCU	Level-1-260C-UNLIM	-40 to 125		

(1) The marketing status values are defined as follows:

ACTIVE: Product device recommended for new designs.

LIFEBUY: TI has announced that the device will be discontinued, and a lifetime-buy period is in effect.

NRND: Not recommended for new designs. Device is in production to support existing customers, but TI does not recommend using this part in a new design.

PREVIEW: Device has been announced but is not in production. Samples may or may not be available.

OBSOLETE: TI has discontinued the production of the device.

(2) Eco Plan - The planned eco-friendly classification: Pb-Free (RoHS), Pb-Free (RoHS Exempt), or Green (RoHS & no Sb/Br) - please check <http://www.ti.com/productcontent> for the latest availability information and additional product content details.

TBD: The Pb-Free/Green conversion plan has not been defined.

Pb-Free (RoHS): TI's terms "Lead-Free" or "Pb-Free" mean semiconductor products that are compatible with the current RoHS requirements for all 6 substances, including the requirement that lead not exceed 0.1% by weight in homogeneous materials. Where designed to be soldered at high temperatures, TI Pb-Free products are suitable for use in specified lead-free processes.

Pb-Free (RoHS Exempt): This component has a RoHS exemption for either 1) lead-based flip-chip solder bumps used between the die and package, or 2) lead-based die adhesive used between the die and leadframe. The component is otherwise considered Pb-Free (RoHS compatible) as defined above.

Green (RoHS & no Sb/Br): TI defines "Green" to mean Pb-Free (RoHS compatible), and free of Bromine (Br) and Antimony (Sb) based flame retardants (Br or Sb do not exceed 0.1% by weight in homogeneous material)

(3) MSL, Peak Temp. - The Moisture Sensitivity Level rating according to the JEDEC industry standard classifications, and peak solder temperature.

(4) There may be additional marking, which relates to the logo, the lot trace code information, or the environmental category on the device.

(5) Multiple Device Markings will be inside parentheses. Only one Device Marking contained in parentheses and separated by a "~" will appear on a device. If a line is indented then it is a continuation of the previous line and the two combined represent the entire Device Marking for that device.

(6) Lead/Ball Finish - Orderable Devices may have multiple material finish options. Finish options are separated by a vertical ruled line. Lead/Ball Finish values may wrap to two lines if the finish value exceeds the maximum column width.

Important Information and Disclaimer:The information provided on this page represents TI's knowledge and belief as of the date that it is provided. TI bases its knowledge and belief on information provided by third parties, and makes no representation or warranty as to the accuracy of such information. Efforts are underway to better integrate information from third parties. TI has taken and continues to take reasonable steps to provide representative and accurate information but may not have conducted destructive testing or chemical analysis on incoming materials and chemicals. TI and TI suppliers consider certain information to be proprietary, and thus CAS numbers and other limited information may not be available for release.

In no event shall TI's liability arising out of such information exceed the total purchase price of the TI part(s) at issue in this document sold by TI to Customer on an annual basis.

TAPE AND REEL INFORMATION

QUADRANT ASSIGNMENTS FOR PIN 1 ORIENTATION IN TAPE

*All dimensions are nominal

Device	Package Type	Package Drawing	Pins	SPQ	Reel Diameter (mm)	Reel Width W1 (mm)	A0 (mm)	B0 (mm)	K0 (mm)	P1 (mm)	W (mm)	Pin1 Quadrant
LP5904TME-1.2/NOPB	DSBGA	YFQ	4	250	178.0	8.4	0.89	0.89	0.76	4.0	8.0	Q1
LP5904TME-2.8/NOPB	DSBGA	YFQ	4	250	178.0	8.4	0.89	0.89	0.76	4.0	8.0	Q1
LP5904TME-2.85/NOPB	DSBGA	YFQ	4	250	178.0	8.4	0.89	0.89	0.76	4.0	8.0	Q1
LP5904TME-3.1/NOPB	DSBGA	YFQ	4	250	178.0	8.4	0.89	0.89	0.76	4.0	8.0	Q1
LP5904TMX-1.2/NOPB	DSBGA	YFQ	4	3000	178.0	8.4	0.89	0.89	0.76	4.0	8.0	Q1
LP5904TMX-2.8/NOPB	DSBGA	YFQ	4	3000	178.0	8.4	0.89	0.89	0.76	4.0	8.0	Q1
LP5904TMX-2.85/NOPB	DSBGA	YFQ	4	3000	178.0	8.4	0.89	0.89	0.76	4.0	8.0	Q1
LP5904TMX-3.1/NOPB	DSBGA	YFQ	4	3000	178.0	8.4	0.89	0.89	0.76	4.0	8.0	Q1

TAPE AND REEL BOX DIMENSIONS

*All dimensions are nominal

Device	Package Type	Package Drawing	Pins	SPQ	Length (mm)	Width (mm)	Height (mm)
LP5904TME-1.2/NOPB	DSBGA	YFQ	4	250	210.0	185.0	35.0
LP5904TME-2.8/NOPB	DSBGA	YFQ	4	250	210.0	185.0	35.0
LP5904TME-2.85/NOPB	DSBGA	YFQ	4	250	210.0	185.0	35.0
LP5904TME-3.1/NOPB	DSBGA	YFQ	4	250	210.0	185.0	35.0
LP5904TMX-1.2/NOPB	DSBGA	YFQ	4	3000	210.0	185.0	35.0
LP5904TMX-2.8/NOPB	DSBGA	YFQ	4	3000	210.0	185.0	35.0
LP5904TMX-2.85/NOPB	DSBGA	YFQ	4	3000	210.0	185.0	35.0
LP5904TMX-3.1/NOPB	DSBGA	YFQ	4	3000	210.0	185.0	35.0

IMPORTANT NOTICE

Texas Instruments Incorporated (TI) reserves the right to make corrections, enhancements, improvements and other changes to its semiconductor products and services per JESD46, latest issue, and to discontinue any product or service per JESD48, latest issue. Buyers should obtain the latest relevant information before placing orders and should verify that such information is current and complete.

TI's published terms of sale for semiconductor products (<http://www.ti.com/sc/docs/stdterms.htm>) apply to the sale of packaged integrated circuit products that TI has qualified and released to market. Additional terms may apply to the use or sale of other types of TI products and services.

Reproduction of significant portions of TI information in TI data sheets is permissible only if reproduction is without alteration and is accompanied by all associated warranties, conditions, limitations, and notices. TI is not responsible or liable for such reproduced documentation. Information of third parties may be subject to additional restrictions. Resale of TI products or services with statements different from or beyond the parameters stated by TI for that product or service voids all express and any implied warranties for the associated TI product or service and is an unfair and deceptive business practice. TI is not responsible or liable for any such statements.

Buyers and others who are developing systems that incorporate TI products (collectively, "Designers") understand and agree that Designers remain responsible for using their independent analysis, evaluation and judgment in designing their applications and that Designers have full and exclusive responsibility to assure the safety of Designers' applications and compliance of their applications (and of all TI products used in or for Designers' applications) with all applicable regulations, laws and other applicable requirements. Designer represents that, with respect to their applications, Designer has all the necessary expertise to create and implement safeguards that (1) anticipate dangerous consequences of failures, (2) monitor failures and their consequences, and (3) lessen the likelihood of failures that might cause harm and take appropriate actions. Designer agrees that prior to using or distributing any applications that include TI products, Designer will thoroughly test such applications and the functionality of such TI products as used in such applications.

TI's provision of technical, application or other design advice, quality characterization, reliability data or other services or information, including, but not limited to, reference designs and materials relating to evaluation modules, (collectively, "TI Resources") are intended to assist designers who are developing applications that incorporate TI products; by downloading, accessing or using TI Resources in any way, Designer (individually or, if Designer is acting on behalf of a company, Designer's company) agrees to use any particular TI Resource solely for this purpose and subject to the terms of this Notice.

TI's provision of TI Resources does not expand or otherwise alter TI's applicable published warranties or warranty disclaimers for TI products, and no additional obligations or liabilities arise from TI providing such TI Resources. TI reserves the right to make corrections, enhancements, improvements and other changes to its TI Resources. TI has not conducted any testing other than that specifically described in the published documentation for a particular TI Resource.

Designer is authorized to use, copy and modify any individual TI Resource only in connection with the development of applications that include the TI product(s) identified in such TI Resource. NO OTHER LICENSE, EXPRESS OR IMPLIED, BY ESTOPPEL OR OTHERWISE TO ANY OTHER TI INTELLECTUAL PROPERTY RIGHT, AND NO LICENSE TO ANY TECHNOLOGY OR INTELLECTUAL PROPERTY RIGHT OF TI OR ANY THIRD PARTY IS GRANTED HEREIN, including but not limited to any patent right, copyright, mask work right, or other intellectual property right relating to any combination, machine, or process in which TI products or services are used. Information regarding or referencing third-party products or services does not constitute a license to use such products or services, or a warranty or endorsement thereof. Use of TI Resources may require a license from a third party under the patents or other intellectual property of the third party, or a license from TI under the patents or other intellectual property of TI.

TI RESOURCES ARE PROVIDED "AS IS" AND WITH ALL FAULTS. TI DISCLAIMS ALL OTHER WARRANTIES OR REPRESENTATIONS, EXPRESS OR IMPLIED, REGARDING RESOURCES OR USE THEREOF, INCLUDING BUT NOT LIMITED TO ACCURACY OR COMPLETENESS, TITLE, ANY EPIDEMIC FAILURE WARRANTY AND ANY IMPLIED WARRANTIES OF MERCHANTABILITY, FITNESS FOR A PARTICULAR PURPOSE, AND NON-INFRINGEMENT OF ANY THIRD PARTY INTELLECTUAL PROPERTY RIGHTS. TI SHALL NOT BE LIABLE FOR AND SHALL NOT DEFEND OR INDEMNIFY DESIGNER AGAINST ANY CLAIM, INCLUDING BUT NOT LIMITED TO ANY INFRINGEMENT CLAIM THAT RELATES TO OR IS BASED ON ANY COMBINATION OF PRODUCTS EVEN IF DESCRIBED IN TI RESOURCES OR OTHERWISE. IN NO EVENT SHALL TI BE LIABLE FOR ANY ACTUAL, DIRECT, SPECIAL, COLLATERAL, INDIRECT, PUNITIVE, INCIDENTAL, CONSEQUENTIAL OR EXEMPLARY DAMAGES IN CONNECTION WITH OR ARISING OUT OF TI RESOURCES OR USE THEREOF, AND REGARDLESS OF WHETHER TI HAS BEEN ADVISED OF THE POSSIBILITY OF SUCH DAMAGES.

Unless TI has explicitly designated an individual product as meeting the requirements of a particular industry standard (e.g., ISO/TS 16949 and ISO 26262), TI is not responsible for any failure to meet such industry standard requirements.

Where TI specifically promotes products as facilitating functional safety or as compliant with industry functional safety standards, such products are intended to help enable customers to design and create their own applications that meet applicable functional safety standards and requirements. Using products in an application does not by itself establish any safety features in the application. Designers must ensure compliance with safety-related requirements and standards applicable to their applications. Designer may not use any TI products in life-critical medical equipment unless authorized officers of the parties have executed a special contract specifically governing such use. Life-critical medical equipment is medical equipment where failure of such equipment would cause serious bodily injury or death (e.g., life support, pacemakers, defibrillators, heart pumps, neurostimulators, and implantables). Such equipment includes, without limitation, all medical devices identified by the U.S. Food and Drug Administration as Class III devices and equivalent classifications outside the U.S.

TI may expressly designate certain products as completing a particular qualification (e.g., Q100, Military Grade, or Enhanced Product). Designers agree that it has the necessary expertise to select the product with the appropriate qualification designation for their applications and that proper product selection is at Designers' own risk. Designers are solely responsible for compliance with all legal and regulatory requirements in connection with such selection.

Designer will fully indemnify TI and its representatives against any damages, costs, losses, and/or liabilities arising out of Designer's non-compliance with the terms and provisions of this Notice.

Looking for pricing, stock, or lifecycle information?

Click below to explore more details on WIN SOURCE:

 [View LP5904TME-1.2/NOPB on WIN SOURCE](#)

 [Texas Instruments](#) Information

Optimize Your Supply Chain with WIN SOURCE Solutions

-  Global Sourcing Solution
-  Obsolete Management
-  Cost Control Management
-  Shortage Management
-  Alternative Solution
-  Excess Inventory Management